

## Series 700 High Performance EMI Filtered D-Sub Connectors

### Filter Selection

Spectrum Control's Series 700 D-Sub connectors offer the highest performance filtering for all types of professional applications.

### Features

- Available in 9, 15, 25, 37, and 50 shell sizes
- Variety of termination configurations including right angle and straight PCB for both pin and socket contact and as an adapter
- Capacitive and Pi type filters in a range of capacitance values

The catalog data for this series is presented in order of shell size, and grouped by pin and socket contacts. Part numbers must be selected from the tables within the series section.

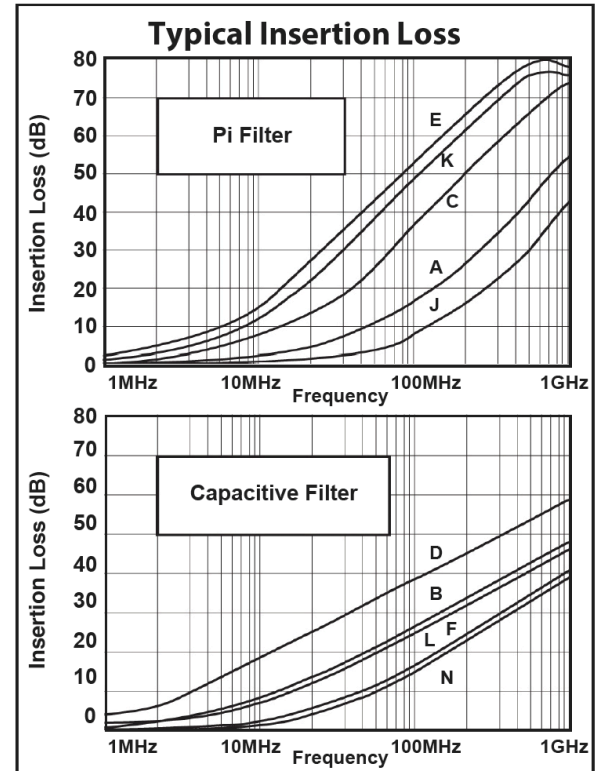

Insertion loss measured per MIL-STD-220, no load, 50ohm source and load.

## Electrical Specifications: High Performance Connectors

Filter Designations	Filter Circuits	Capacitance		3 dB Cut-off Frequency Max. (MHz)	Dielectric With-Standing Voltage	Working Voltage DC -55°C to +125°C	Minimum Insertion Loss - Decibels (dB)							
		Value	Tol.				5 MHz	10 MHz	20 MHz	50 MHz	100 MHz	200 MHz	500 MHz	1 GHz
J	Pi	100 pF	+100 -0%	32	300V	100V	—	—	—	2	5	8	16	33
C		1000 pF	+150 -0%	3.2	300V	100V	—	3	8	17	27	39	58	70
K		2500 pF	+100 -0%	1.3	150V	50V	6	10	15	30	42	55	70	70
E		4000 pF	+100 -0%	0.8	150V	50V	8	13	20	37	50	64	70	70
B	C	1000 pF	+100 -0%	3.2	600V	200V	—	4	9	16	22	28	36	42
D		5000 pF	+100 -0%	0.64	300V	100V	10	16	22	30	35	41	50	56

Filter designation "G" for grounded contacts, "I" for insulated (not filtered) contacts. Filter designation "O" for omitted contact and no hole in ground plane.

Above data represents guaranteed minimum.

## Specifications and Connector Ordering

### Mechanical Specifications

Shell	Zinc or aluminum diecast, nickel plated 150 $\mu$ inches (3.81 $\mu$ m) min
Insulators	Glass-filled polyester, flammability UL94V-0
Pin Contacts	Copper alloy, 15 $\mu$ inches (0.38 $\mu$ m) gold plated * over nickel
Socket Contacts	Copper alloy, 30 $\mu$ inches (0.76 $\mu$ m) gold plated * over nickel  * Heavier gold plating available upon request
Terminations	See pg. 23: Connector Options Gold flash for PCB mount and solder cups. Solder dipped also available
Ground Plane	Brass, solder plated
Grounding Springs	Beryllium copper, tin plated per MIL-T-10727
Operating Temperature	-55°C to +125°C
Capacitors	Proprietary barium titanate ceramic formulations

### Electrical Specifications

Current Rating	5 Amps
R.F. Current Rating	0.3 Amps
Contact Resistance	10 milliohms maximum
UL Recognized	Under category of communication circuit accessories, File #E149046
Inductance on PI Filters	~ 860 nH between 100 kHz and 1 MHz

Solder cups accept up to a 20 gauge wire.

## Ordering Your Connector

### Step 1: Selecting the Filter

- Using the insertion loss graphs on page 1 determine which filters provide the required attenuation at the troublesome frequency, while not affecting the signal frequency by more than 3 to 6 dB.
- Choose the filter type, either feedthrough capacitor or Pi. Pi is generally considered better due to its superior high frequency performance and steeper curve. The feedthrough capacitor is lower cost.
- Select capacitance value.
- Note the Spectrum Control letter designation for the filter chosen from the table on page 1.

### Step 2: Selecting the Connector

- Turn to the appropriate size section (9, 15, 25, 37, 50).
- Choose either pin contacts (plug) or socket contacts (receptacle).
- Choose the required termination type.
- From the table on the appropriate connector page, using the filter letter designation chosen in step 1 above, select the part number.

### Step 3: Specifying Options

- Refer to page 23 for special options including heavy gold plating, 4-40 mounting threads, grounding brackets, hardware, and others.
- Most options are available within the standard lead times.
- Some options require a part number suffix, while other combinations may require factory assistance for part number assignment. If a suffix is shown, add it to your selected part number. If more than one option is needed, contact Spectrum Control for part number assignment.

**Series 700 Pin Contact**  
9 Shell Size

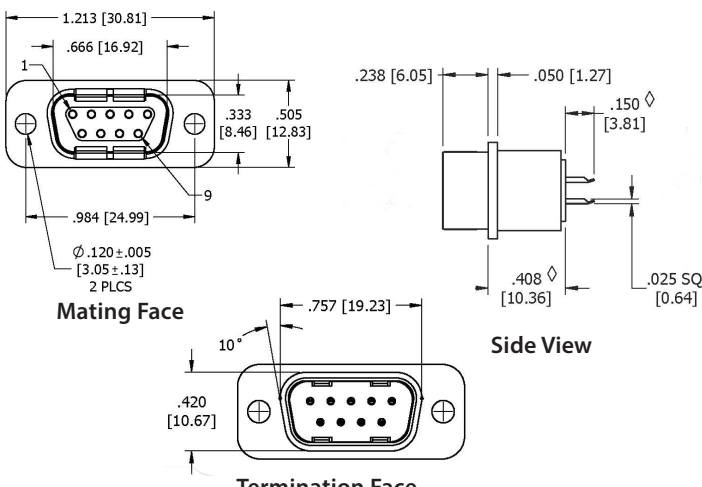

**Printed Circuit Board Mount**

Spectrum Control Part Number	EMI Filter			
	Filter Designation**	Cap. Value		
56-701-002	B	1000 pF C		
56-701-003	C	1000 pF Pi		
56-701-004	D	5000 pF C		
56-701-005	E	4000 pF Pi		
56-701-029	J	100 pF Pi		
56-701-030	K	2500 pF Pi		

**Printed Circuit Board Right Angle Mount**

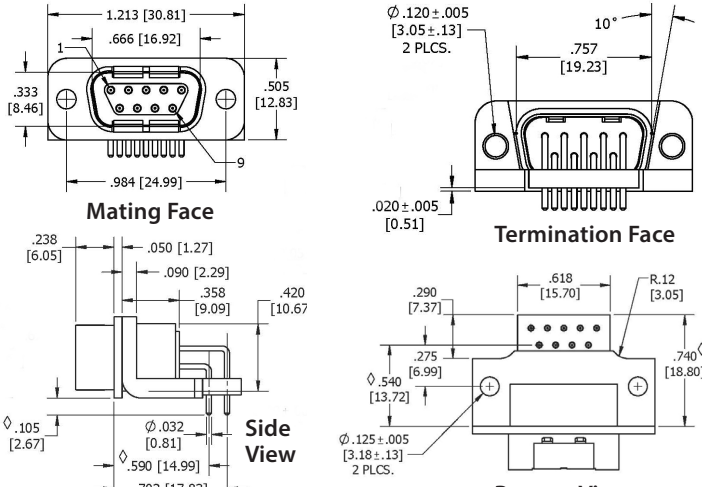
Spectrum Control Part Number	EMI Filter			
	Filter Designation**	Cap. Value		
56-702-002	B	1000 pF C		
56-702-003	C	1000 pF Pi		
56-702-004	D	5000 pF C		
56-702-005	E	4000 pF Pi		
56-702-008	J	100 pF Pi		
56-702-009	K	2500 pF Pi		

\*Replace "56-" with "56F" to indicate RoHS compliant Dimensions in inches [mm]

\*\*See page 1 for filter performance

Standard Tolerance = ±.005 except where noted, ∅ = ±.015

Dimensions in inches [mm]

**Series 700 Pin Contact**

9 Shell Size

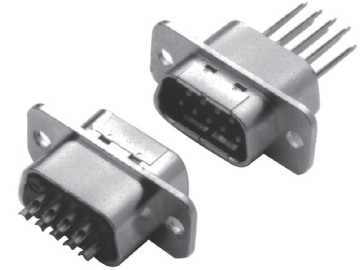

**Solder Cup Termination**

Spectrum Control Part Number	EMI Filter	
	Filter Designation**	Cap. Value
56-701-012	B	1000 pF C
56-701-013	C	1000 pF Pi
56-701-014	D	5000 pF C
56-701-015	E	4000 pF Pi
56-701-041	J	100 pF Pi
56-701-042	K	2500 pF Pi

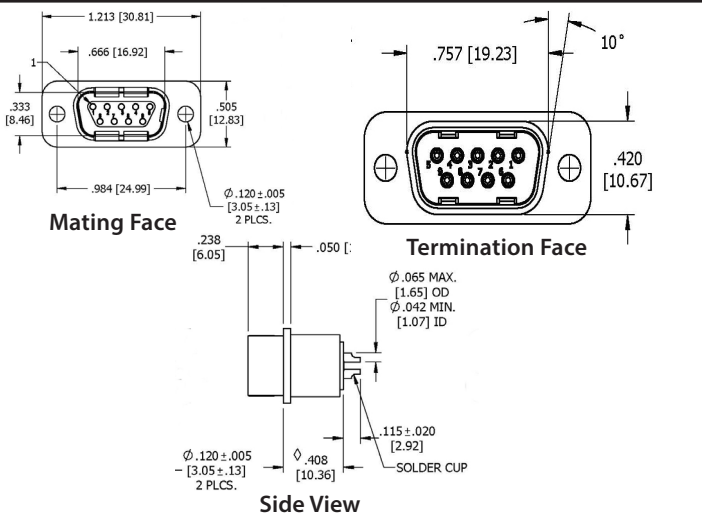

**Mating Face**

**Termination Face**

**Side View**

\*Replace "56-" with "56F" to indicate RoHS compliant Dimensions in inches [mm]

\*\*See page 1 for filter performance

Standard Tolerance = ±.005 except where noted,  $\phi = \pm .015$

Dimensions in inches [mm]



**Series 700 Socket Contact**

9 Shell Size

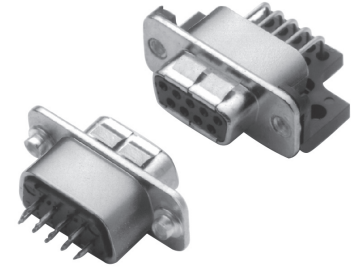

**Printed Circuit Board Mount**

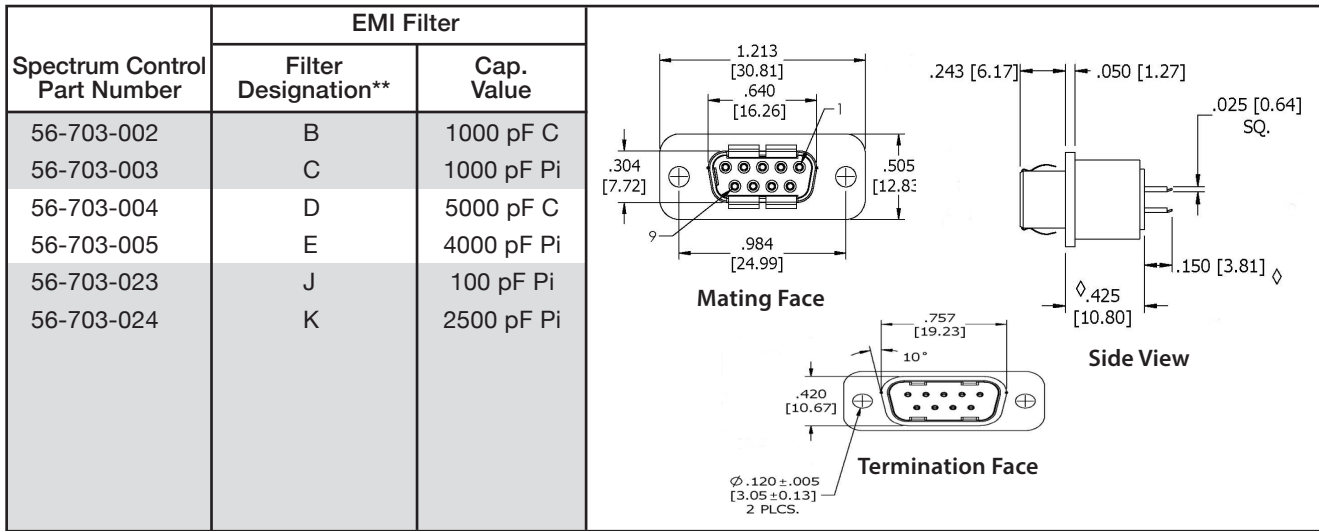

**Printed Circuit Board Right Angle Mount**

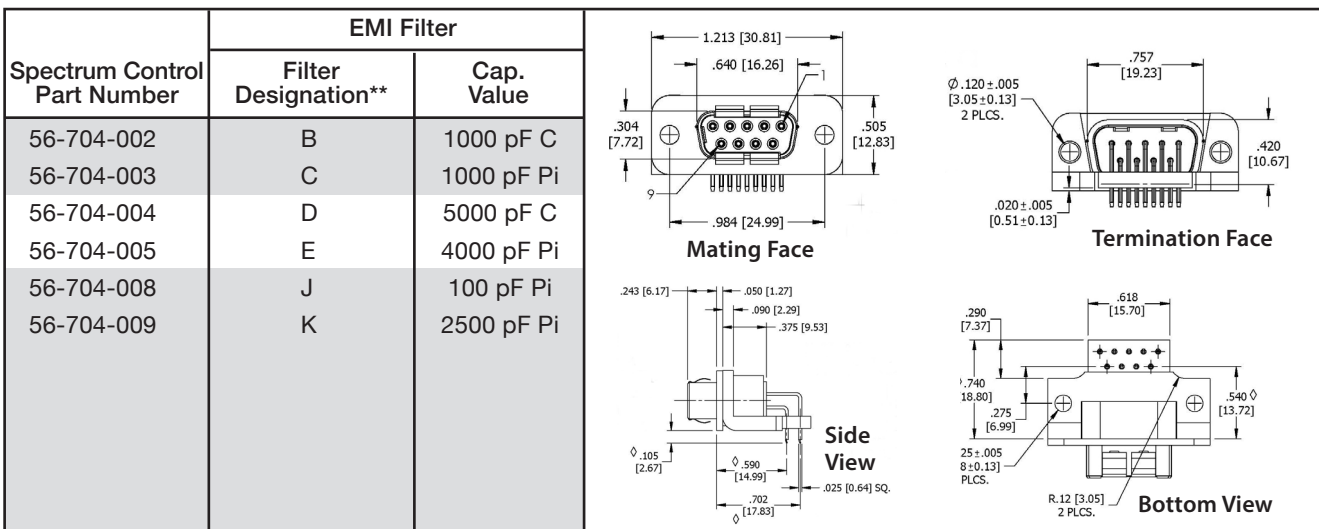

\*Replace "56-" with "56F" to indicate RoHS compliant Dimensions in inches [mm]

\*\*See page 1 for filter performance

Standard Tolerance =  $\pm .005$  except where noted,  $\phi = \pm .015$

Dimensions in inches [mm]

**Series 700 Socket Contact & Pin/Socket Adapter**

9 Shell Size



**Solder Cup Termination**

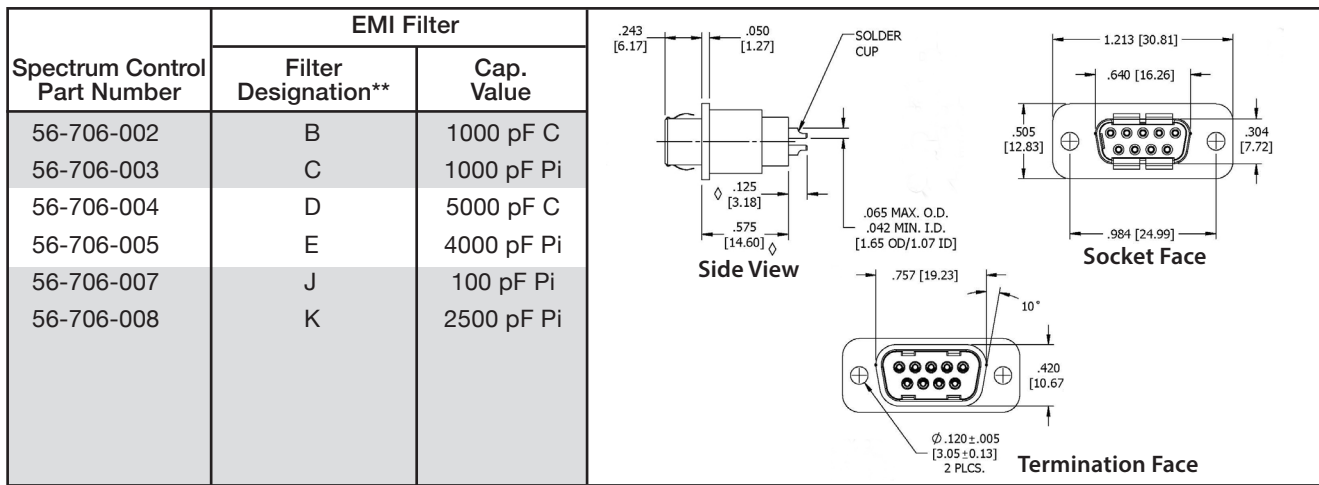

**Pin/Socket Adapter**

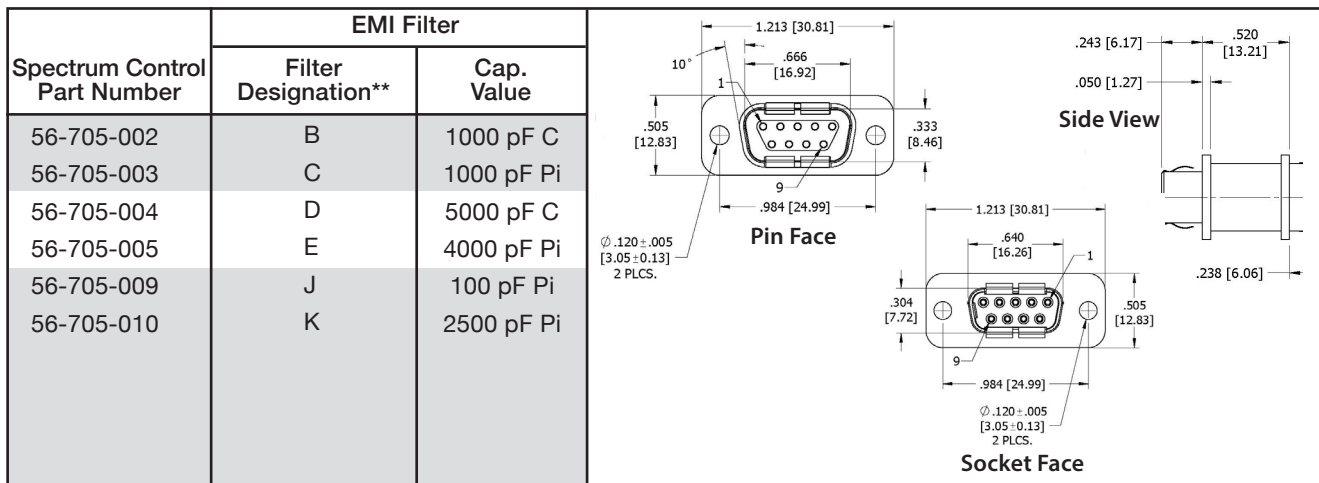

\*Replace "56-" with "56F" to indicate RoHS compliant Dimensions in inches [mm]

\*\*See page 1 for filter performance

Standard Tolerance = ±.005 except where noted,  $\phi = \pm .015$

Dimensions in inches [mm]

**Series 700 Pin Contact**

15 Shell Size

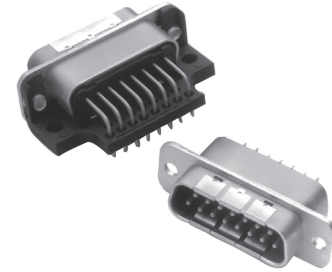

**Printed Circuit Board Mount**

Spectrum Control Part Number	EMI Filter		Mating Face	Side View	Termination Face
	Filter Designation**	Cap. Value			
56-711-002	B	1000 pF C			
56-711-003	C	1000 pF Pi			
56-711-004	D	5000 pF C			
56-711-005	E	4000 pF Pi			
56-711-029	J	100 pF Pi			
56-711-030	K	2500 pF Pi			

**Printed Circuit Board Right Angle Mount**

Spectrum Control Part Number	EMI Filter		Mating Face	Side View	Termination Face	Bottom View
	Filter Designation**	Cap. Value				
56-712-002	B	1000 pF C				
56-712-003	C	1000 pF Pi				
56-712-004	D	5000 pF C				
56-712-005	E	4000 pF Pi				
56-712-008	J	100 pF Pi				
56-712-009	K	2500 pF Pi				

\*Replace "56-" with "56F" to indicate RoHS compliant Dimensions in inches [mm]

\*\*See page 1 for filter performance

Standard Tolerance =  $\pm .005$  except where noted,  $\phi = \pm .015$

Dimensions in inches [mm]

**Series 700 Pin Contact**

15 Shell Size



**Solder Cup Termination**

Spectrum Control Part Number	EMI Filter	
	Filter Designation**	Cap. Value
56-711-012	B	1000 pF C
56-711-013	C	1000 pF Pi
56-711-014	D	5000 pF C
56-711-015	E	4000 pF Pi
56-711-041	J	100 pF Pi
56-711-042	K	2500 pF Pi

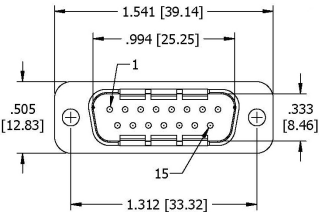

**Mating Face**

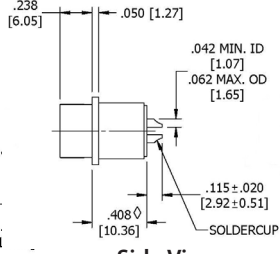

**Side View**

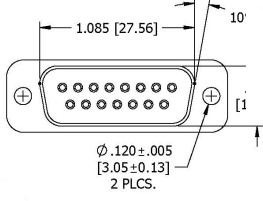

**Termination Face**

\*Replace "56-" with "56F" to indicate RoHS compliant Dimensions in inches [mm]

\*\*See page 1 for filter performance

Standard Tolerance = ±.005 except where noted, ∅ = ±.015

Dimensions in inches [mm]

**Series 700 Socket Contact**

15 Shell Size



**Printed Circuit Board Mount**

Spectrum Control Part Number	EMI Filter	
	Filter Designation**	Cap. Value
56-713-002	B	1000 pF C
56-713-003	C	1000 pF Pi
56-713-004	D	5000 pF C
56-713-005	E	4000 pF Pi
56-713-022	J	100 pF Pi
56-713-023	K	2500 pF Pi

**Printed Circuit Board Right Angle Mount**

Spectrum Control Part Number	EMI Filter	
	Filter Designation**	Cap. Value
56-714-002	B	1000 pF C
56-714-003	C	1000 pF Pi
56-714-004	D	5000 pF C
56-714-005	E	4000 pF Pi
56-714-007	J	100 pF Pi
56-714-008	K	2500 pF Pi

\*Replace "56-" with "56F" to indicate RoHS compliant Dimensions in inches [mm]  
 \*\*See page 1 for filter performance  
 Standard Tolerance = ±.005 except where noted, Ø = ±.015

Dimensions in inches [mm]

**Series 700 Socket Contact & Pin/Socket Adapter**

15 Shell Size



**Solder Cup Termination**

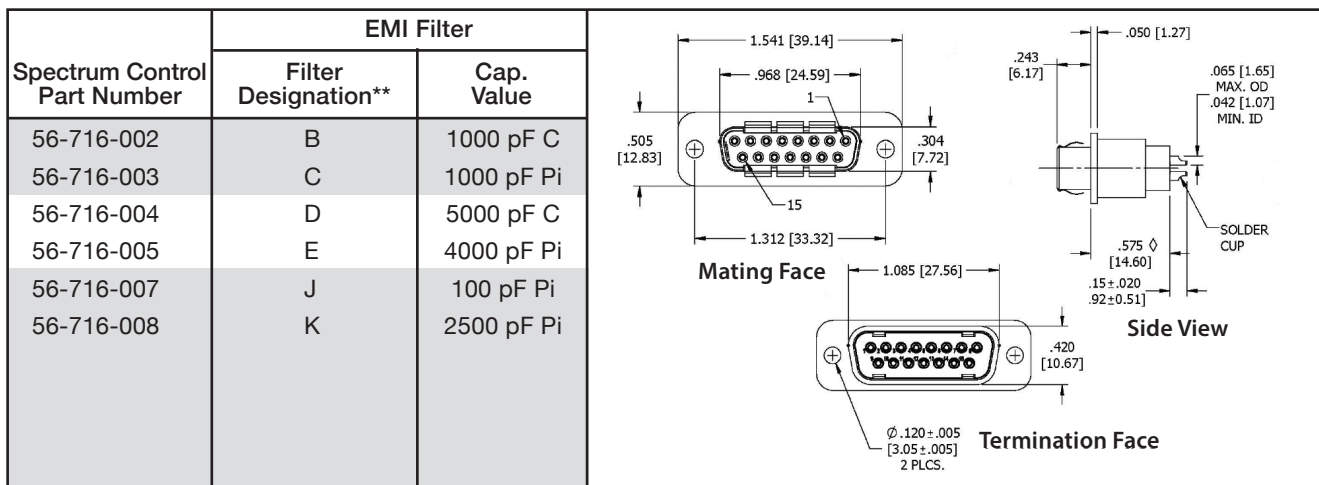

**Pin/Socket Adapter**

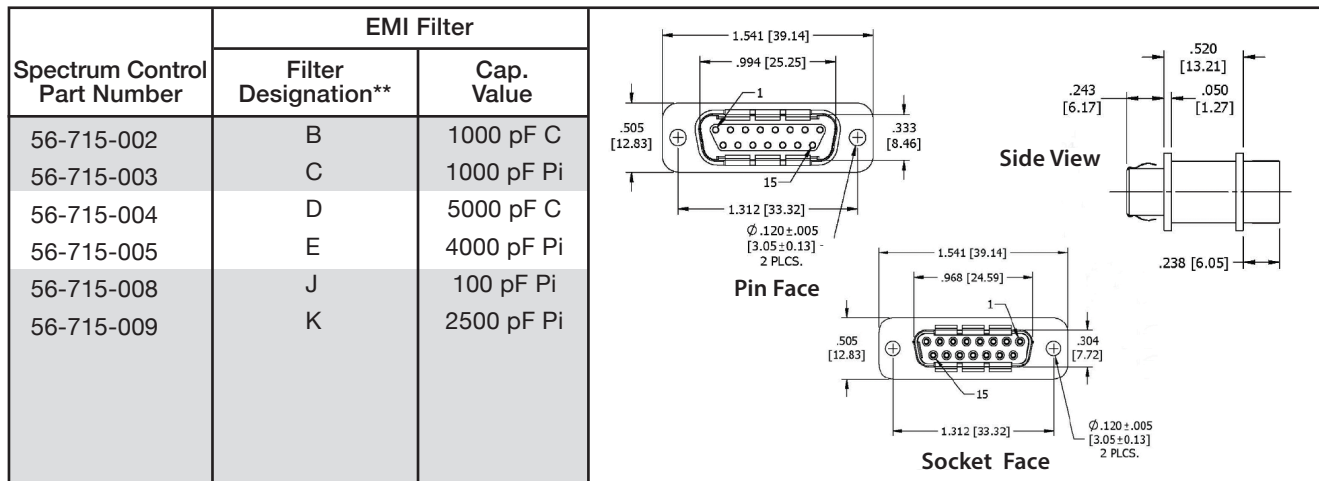

\*Replace "56-" with "56F" to indicate RoHS compliant  
 \*\*See page 1 for filter performance  
 Standard Tolerance =  $\pm$ .005 except where noted,  $\phi$  =  $\pm$ .015

Dimensions in inches [mm]

**Series 700 Pin Contact**

25 Shell Size

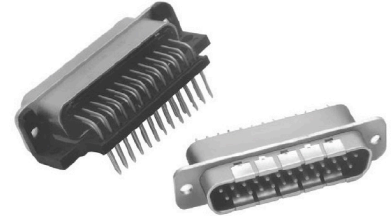

**Printed Circuit Board Mount**

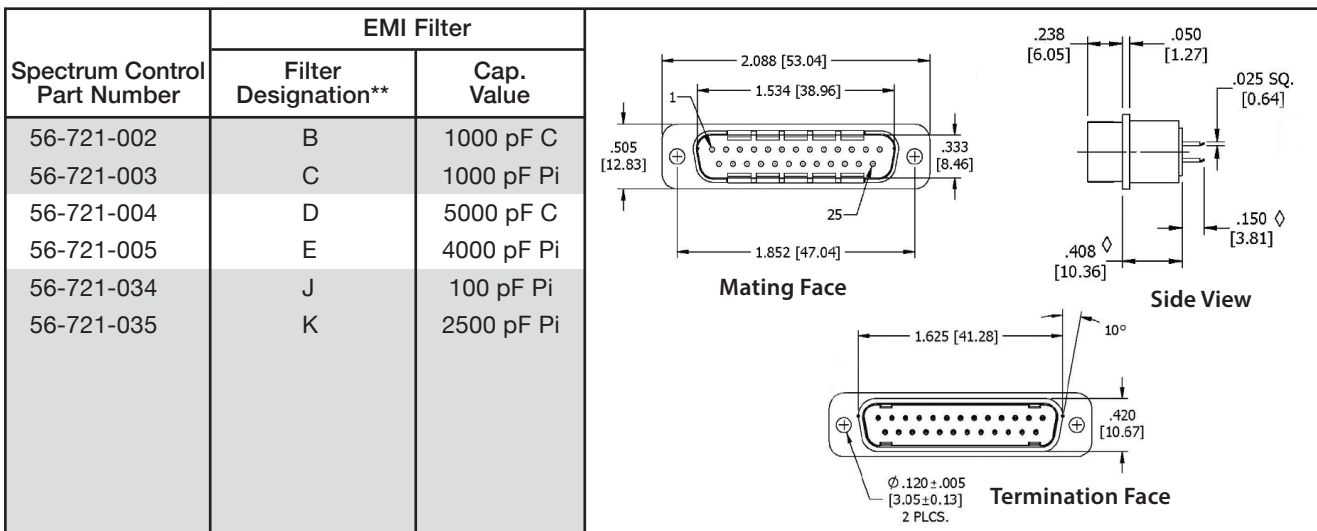

**Printed Circuit Board Right Angle Mount**

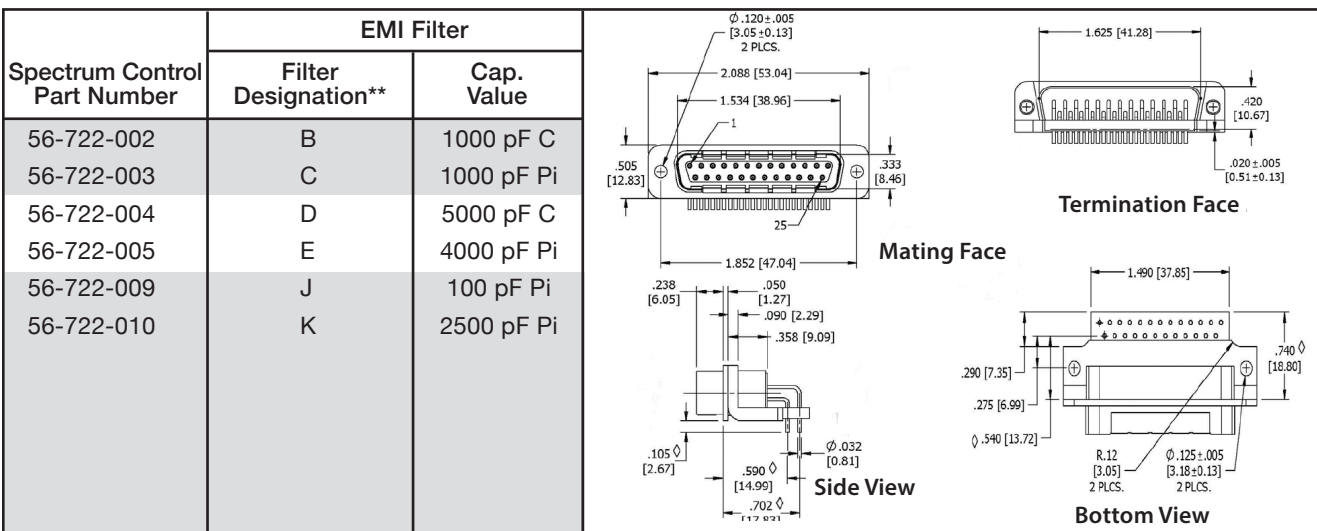

\*Replace "56-" with "56F" to indicate RoHS compliant Dimensions in inches [mm]

\*\*See page 1 for filter performance

Standard Tolerance = ±.005 except where noted, ∅ = ±.015

Dimensions in inches [mm]



**Series 700 Pin Contact**

25 Shell Size



**Solder Cup Termination**

Spectrum Control Part Number	EMI Filter	
	Filter Designation**	Cap. Value
56-721-012	B	1000 pF C
56-721-013	C	1000 pF Pi
56-721-014	D	5000 pF C
56-721-015	E	4000 pF Pi
56-721-046	J	100 pF Pi
56-721-047	K	2500 pF Pi

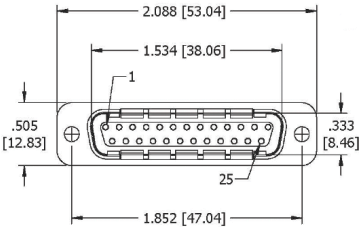

**Mating Face**

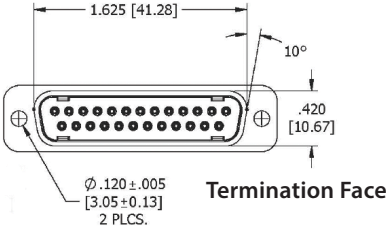

**Termination Face**

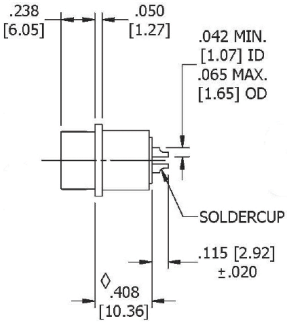

**Side View**

\*Replace "56-" with "56F" to indicate RoHS compliant Dimensions in inches [mm]  
 \*\*See page 1 for filter performance  
 Standard Tolerance = ±.005 except where noted,  $\phi = \pm .015$

Dimensions in inches [mm]

**Series 700 Socket Contact**

25 Shell Size

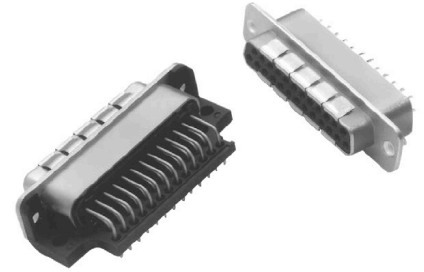

**Printed Circuit Board Mount**

Spectrum Control Part Number	EMI Filter	
	Filter Designation**	Cap. Value
56-723-002	B	1000 pF C
56-723-003	C	1000 pF Pi
56-723-004	D	5000 pF C
56-723-005	E	4000 pF Pi
56-723-024	J	100 pF Pi
56-723-025	K	2500 pF Pi

**Printed Circuit Board Right Angle Mount**

Spectrum Control Part Number	EMI Filter	
	Filter Designation**	Cap. Value
56-724-002	B	1000 pF C
56-724-003	C	1000 pF Pi
56-724-004	D	5000 pF C
56-724-005	E	4000 pF Pi
56-724-009	J	100 pF Pi
56-724-010	K	2500 pF Pi

\*Replace "56-" with "56F" to indicate RoHS compliant Dimensions in inches [mm]

\*\*See page 1 for filter performance

Standard Tolerance = ±.005 except where noted, Ø = ±.015

Dimensions in inches [mm]

**Series 700 Socket Contact & Pin/Socket Adapter**

25 Shell Size



**Solder Cup Terminator**

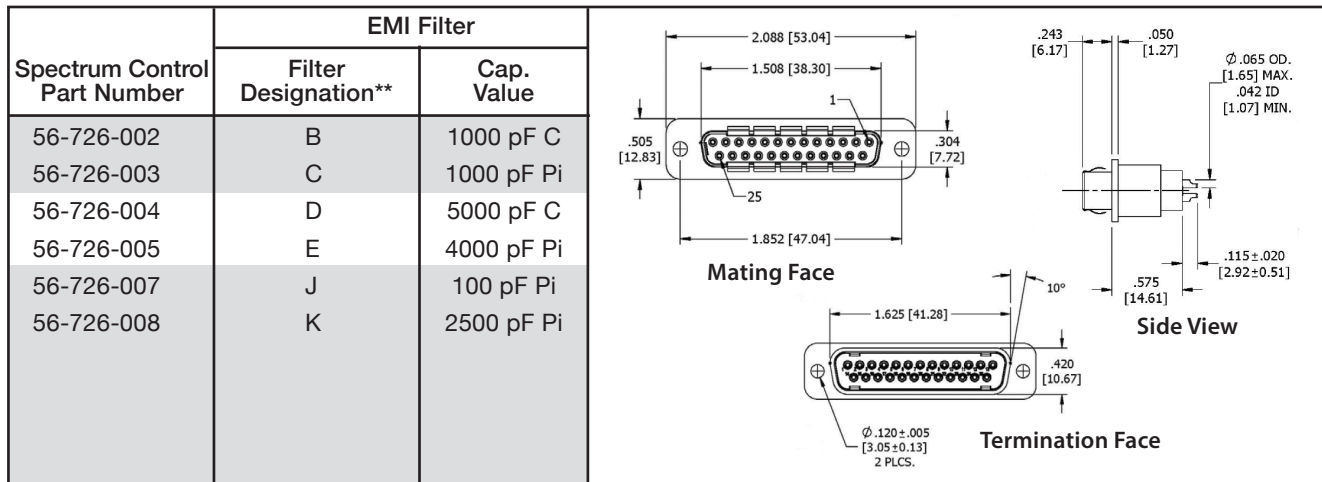

**Pin/Socket Adapter**

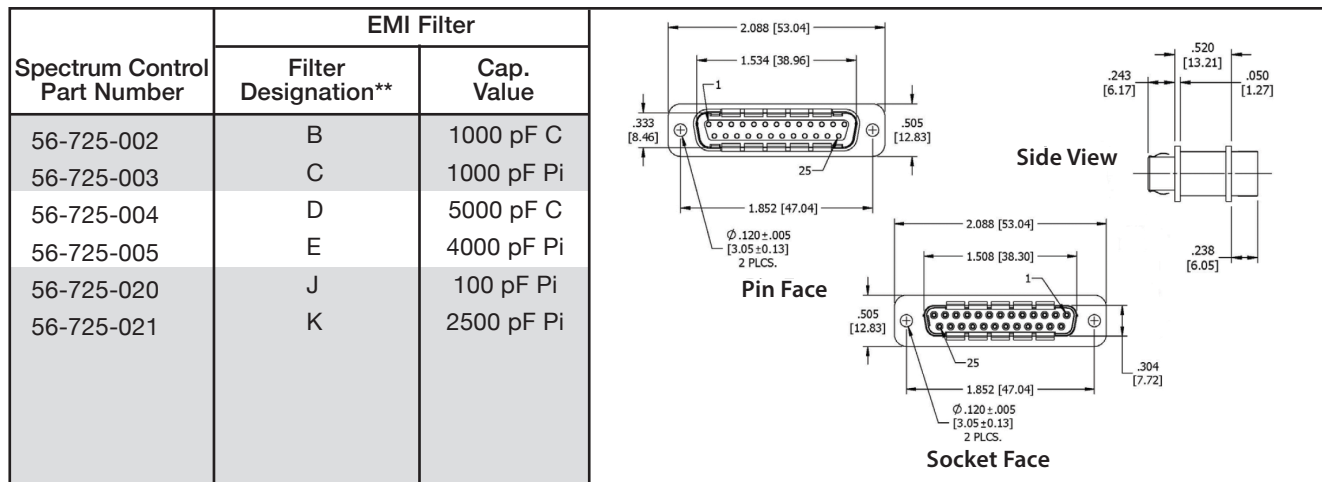

\*Replace "56-" with "56F" to indicate RoHS compliant Dimensions in inches [mm]  
 \*\*See page 1 for filter performance  
 Standard Tolerance = ±.005 except where noted,  $\phi$  = ±.015

Dimensions in inches [mm]

**Series 700 Pin Contact**

37 Shell Size



**Printed Circuit Board Mount**

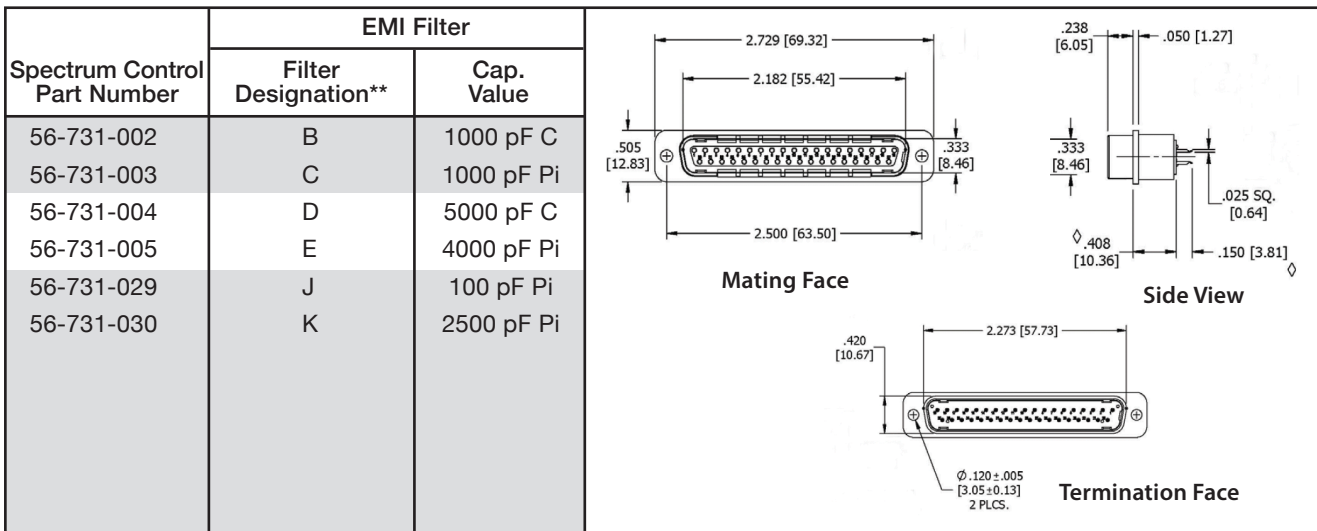

**Printed Circuit Board Right Angle Mount**

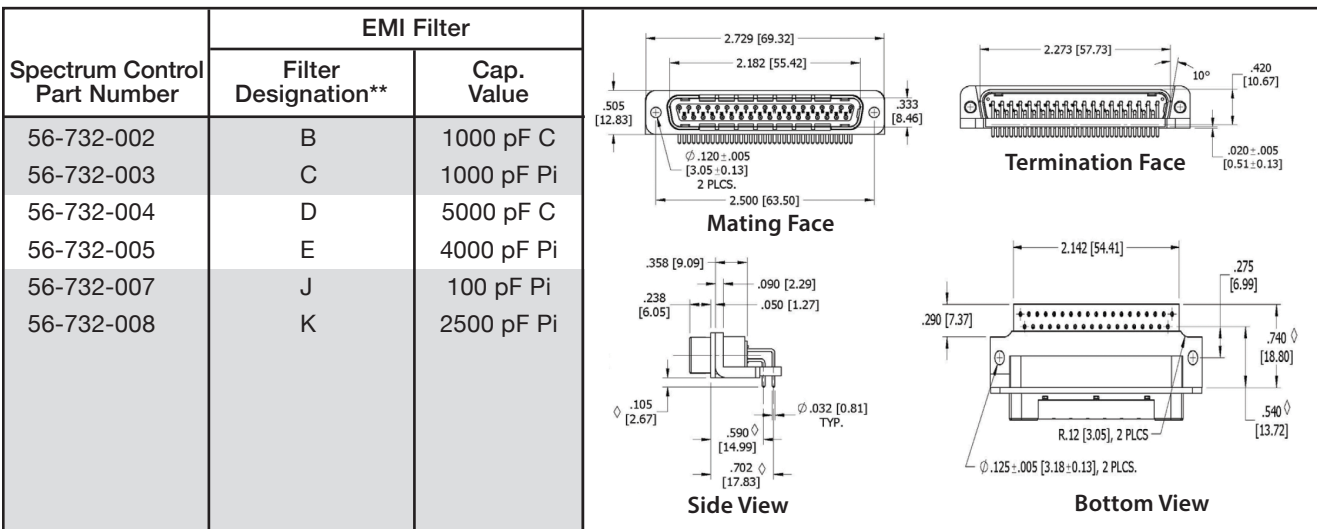

\*Replace "56-" with "56F" to indicate RoHS compliant Dimensions in inches [mm]

\*\*See page 1 for filter performance

Standard Tolerance = ±.005 except where noted, ∅ = ±.015

Dimensions in inches [mm]

**Series 700 Pin Contact**

37 Shell Size

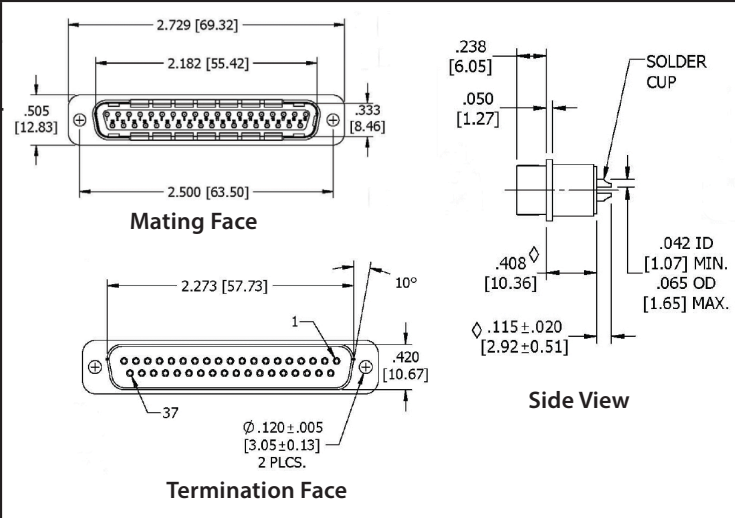

**Solder Cup Termination**

Spectrum Control Part Number	EMI Filter		Mating Face	Side View
	Filter Designation**	Cap. Value		
56-731-012	B	1000 pF C	 <p><b>Mating Face</b></p> <p><b>Termination Face</b></p> <p><b>Side View</b></p>	<p>SOLDER CUP</p> <p>.042 ID [1.07] MIN. .065 OD [1.65] MAX.</p>
56-731-013	C	1000 pF Pi		
56-731-014	D	5000 pF C		
56-731-015	E	4000 pF Pi		
56-731-041	J	100 pF Pi		
56-731-042	K	2500 pF Pi		

\*Replace "56-" with "56F" to indicate RoHS compliant Dimensions in inches [mm]

\*\*See page 1 for filter performance

Standard Tolerance = ±.005 except where noted, ∅ = ±.015

Dimensions in inches [mm]

**Series 700 Socket Contact**

37 Shell Size

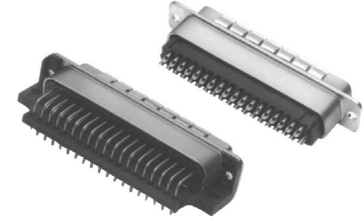

**Printed Circuit Board Mount**

Spectrum Control Part Number	EMI Filter		Mating Face	Side View
	Filter Designation**	Cap. Value		
56-733-002	B	1000 pF C		
56-733-003	C	1000 pF Pi		
56-733-004	D	5000 pF C		
56-733-005	E	4000 pF Pi		
56-733-022	J	100 pF Pi		
56-733-023	K	2500 pF Pi		

			Termination Face

**Printed Circuit Board Right Angle Mount**

Spectrum Control Part Number	EMI Filter		Mating Face	Termination Face
	Filter Designation**	Cap. Value		
56-734-002	B	1000 pF C		
56-734-003	C	1000 pF Pi		
56-734-004	D	5000 pF C		
56-734-005	E	4000 pF Pi		
56-734-007	J	100 pF Pi		
56-734-008	K	2500 pF Pi		

			Side View	Bottom View

\*Replace "56-" with "56F" to indicate RoHS compliant Dimensions in inches [mm]

\*\*See page 1 for filter performance

Standard Tolerance = ±.005 except where noted, ∅ = ±.015

Dimensions in inches [mm]

**Series 700 Socket Contact & Pin/Socket Adapter**

37 Shell Size

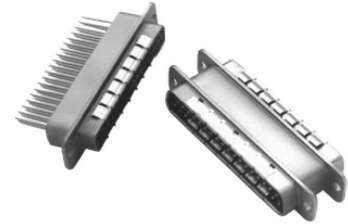

**Solder Cup Termination**

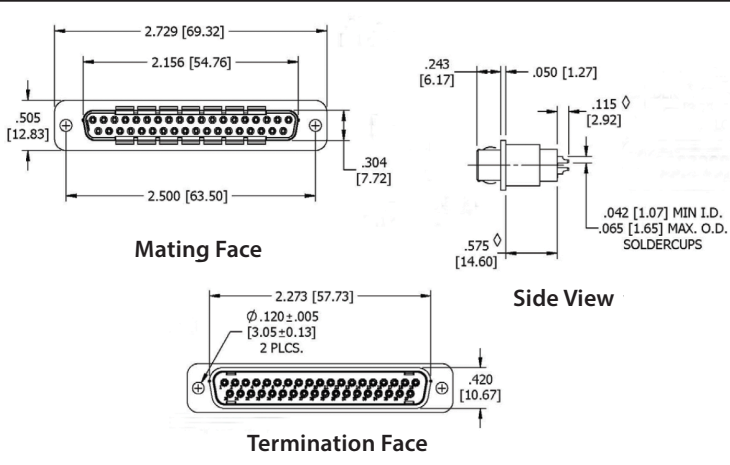
Spectrum Control Part Number	EMI Filter		Mating Face	Side View
	Filter Designation**	Cap. Value		
56-736-002	B	1000 pF C		
56-736-003	C	1000 pF Pi		
56-736-004	D	5000 pF C		
56-736-005	E	4000 pF Pi		
56-736-007	J	100 pF Pi		
56-736-008	K	2500 pF Pi		

**Pin/Socket Adapter**

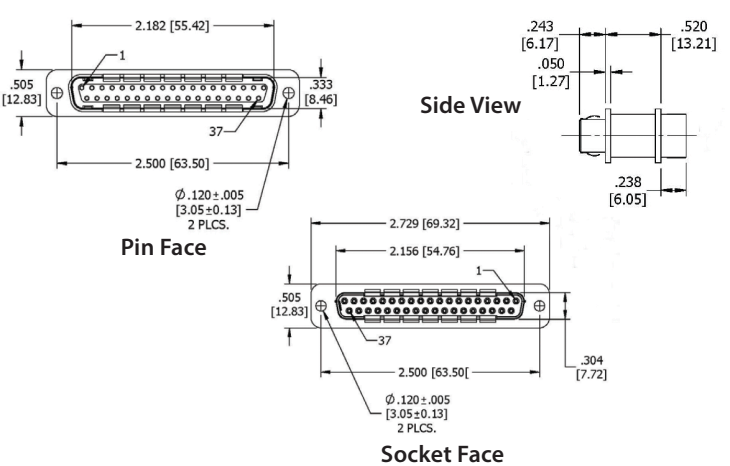
Spectrum Control Part Number	EMI Filter		Pin Face	Side View	Socket Face
	Filter Designation**	Cap. Value			
56-735-002	B	1000 pF C			
56-735-003	C	1000 pF Pi			
56-735-004	D	5000 pF C			
56-735-005	E	4000 pF Pi			
56-735-009	J	100 pF Pi			
56-735-010	K	2500 pF Pi			

\*Replace "56-" with "56F" to indicate RoHS compliant Dimensions in inches [mm]

\*\*See page 1 for filter performance

Standard Tolerance = ±.005 except where noted, ∅ = ±.015

Dimensions in inches [mm]



**Series 700 Pin Contact**

50 Shell Size

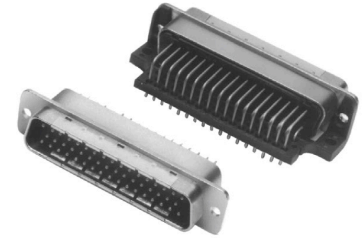

**Printed Circuit Board Mount**

Spectrum Control Part Number	EMI Filter	
	Filter Designation**	Cap. Value
56-741-002	B	1000 pF C
56-741-003	C	1000 pF Pi
56-741-004	D	5000 pF C
56-741-005	E	4000 pF Pi
56-741-028	J	100 pF Pi
56-741-029	K	2500 pF Pi

**Printed Circuit Board Right Angle Mount**

Spectrum Control Part Number	EMI Filter	
	Filter Designation**	Cap. Value
56-742-002	B	1000 pF C
56-742-003	C	1000 pF Pi
56-742-004	D	5000 pF C
56-742-005	E	4000 pF Pi
56-742-007	J	100 pF Pi
56-742-008	K	2500 pF Pi

\*Replace "56-" with "56F" to indicate RoHS compliant Dimensions in inches [mm]

\*\*See page 1 for filter performance

Standard Tolerance = ±.005 except where noted, Ø = ±.015

Dimensions in inches [mm]

**Series 700 Pin Contact**

50 Shell Size

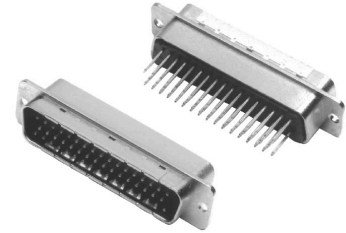

**Solder Cup Termination**

Spectrum Control Part Number	EMI Filter	
	Filter Designation**	Cap. Value
56-741-012	B	1000 pF C
56-741-013	C	1000 pF Pi
56-741-014	D	5000 pF C
56-741-015	E	4000 pF Pi
56-741-040	J	100 pF Pi
56-741-041	K	2500 pF Pi

\*Replace "56-" with "56F" to indicate RoHS compliant Dimensions in inches [mm]  
 \*\*See page 1 for filter performance  
 Standard Tolerance = ±.005 except where noted,  $\phi = \pm .015$

Dimensions in inches [mm]

**Series 700 Socket Contact**

50 Shell Size



**Printed Circuit Board Mount**

Spectrum Control Part Number	EMI Filter	
	Filter Designation**	Cap. Value
56-743-002	B	1000 pF C
56-743-003	C	1000 pF Pi
56-743-004	D	5000 pF C
56-743-005	E	4000 pF Pi
56-743-022	J	100 pF Pi
56-743-023	K	2500 pF Pi

**Printed Circuit Board Right Angle Mount**

Spectrum Control Part Number	EMI Filter	
	Filter Designation**	Cap. Value
56-743-002	B	1000 pF C
56-743-003	C	1000 pF Pi
56-743-004	D	5000 pF C
56-743-005	E	4000 pF Pi
56-743-007	J	100 pF Pi
56-743-008	K	2500 pF Pi

\*Replace "56-" with "56F" to indicate RoHS compliant Dimensions in inches [mm]

\*\*See page 1 for filter performance

Standard Tolerance =  $\pm .005$  except where noted,  $\phi = \pm .015$

Dimensions in inches [mm]

**Series 700 Socket Contact & Pin/Socket Adapter**

50 Shell Size



**Solder Cup Termination**

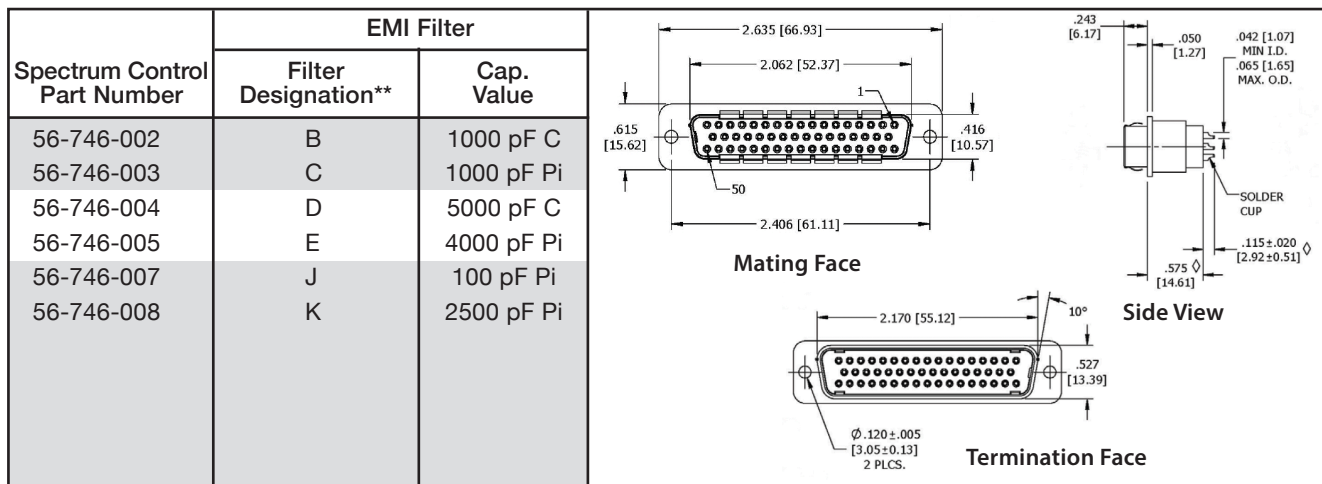

**Pin/Socket Adapter**

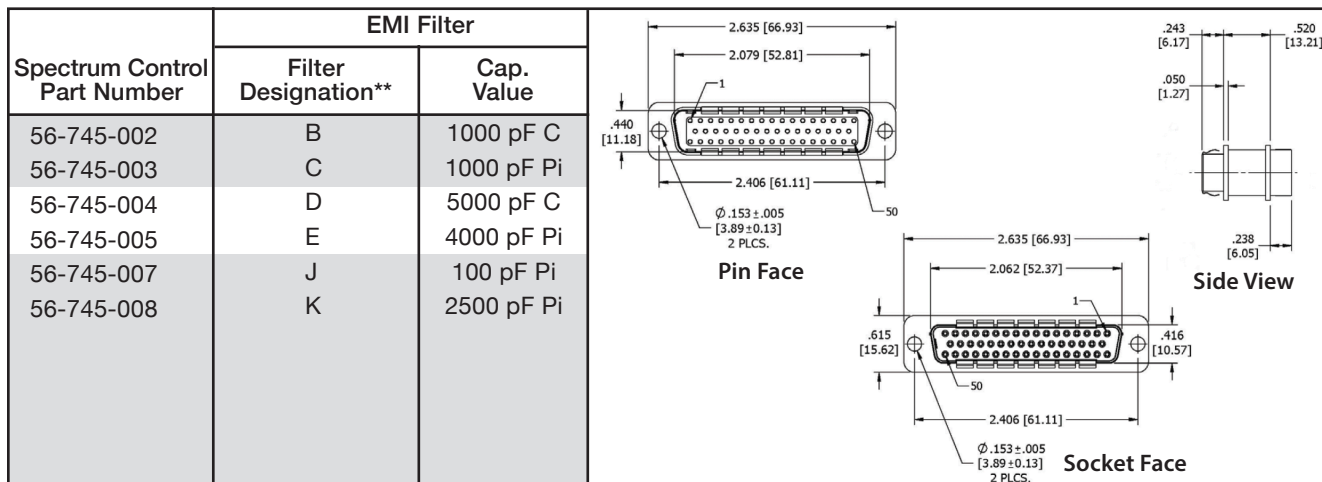

\*Replace "56-" with "56F" to indicate RoHS compliant Dimensions in inches [mm]

\*\*See page 1 for filter performance

Standard Tolerance = ±.005 except where noted,  $\phi$  = ±.015

Dimensions in inches [mm]

## D-Subminiature Connector Options

### Threaded Locking Inserts (LI)

Available on Series 600 & 700.

- #4-40 UNC or metric M3.0 threaded inserts in mounting flanges.
- Allows ease of panel-assembly.
- Plated steel inserts with last thread upset for torque.

### Grounding Bracket (GB)

For right angle mount PCB connectors, available on Series 700.

- Metal bracket in place of plastic.
- Provides ground connection direct from circuit board.
- Allows shell grounding to board.
- Includes 4-40 threads.

### Stand-off with Board Lock Feature (GBL6)

For straight PCB connectors, available on Series 700.

- Allows shell grounding to board.
- Eliminates stress on filter temperature.
- Tin plated brass stand-off with snap-in feature.
- Available for .062" (1.57mm) or .093" (2.36mm).

### Grounding Bracket with Board Lock (GBL)

For right angle mount PCB connectors, available on 700.

- Metal bracket provides grounding.
- Snap-in, no hardware needed, 4-40 threads included.
- For use on .062" (1.57mm) thick boards.

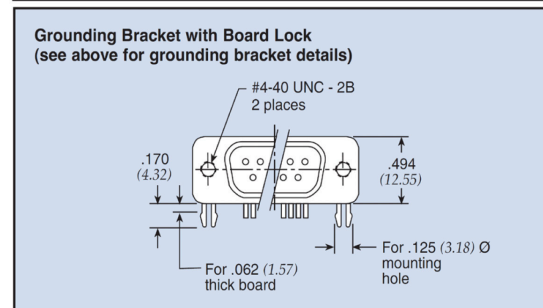
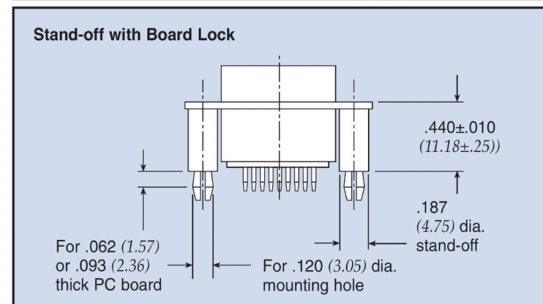
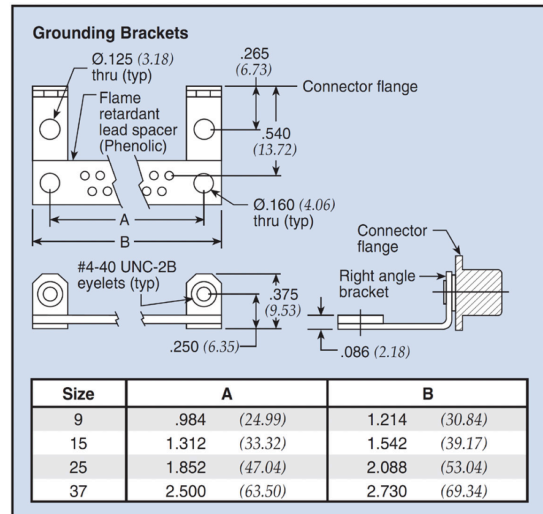
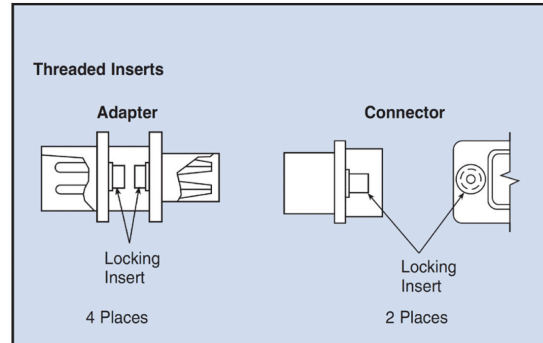

Dimensions in inches [mm]

# Mouser Electronics

Authorized Distributor

Click to View Pricing, Inventory, Delivery & Lifecycle Information:

## [Spectrum Control:](#)

[56-735-003](#) [56-735-004](#) [56-735-005](#) [56-732-005](#) [56-732-003](#) [56-705-003](#) [56-705-004](#) [56-705-005](#) [56-705-009](#)  
[56-703-003](#) [56-702-005](#) [56-702-009](#) [56-702-002](#) [56-702-003](#) [56-736-008](#) [56-736-003](#) [56-736-005](#) [56-701-013](#) [56-](#)  
[701-015](#) [56-701-012](#) [56-701-014](#) [56-706-008](#) [56-706-005](#) [56-706-007](#) [56-706-003](#) [56-701-041](#) [56-715-004](#) [56-](#)  
[715-005](#) [56-715-003](#) [56-725-004](#) [56-725-005](#) [56-731-030](#) [56-725-003](#) [56-731-015](#) [56-731-042](#) [56-731-013](#) [56-](#)  
[725-021](#) [56-711-015](#) [56-711-014](#) [56-711-013](#) [56-711-005](#) [56-701-029](#) [56-721-046](#) [56-725-020](#) [56-731-012](#) [56-](#)  
[741-003](#) [56-712-002](#) [56-735-010](#) [56-726-003](#) [56-726-008](#) [56-726-002](#) [56-726-005](#) [56-721-014](#) [56-713-023](#) [56-](#)  
[722-004](#) [56-722-005](#) [56-722-010](#) [56-722-003](#) [56-714-003](#) [56-714-005](#) [56-714-004](#) [56-712-003](#) [56-712-004](#) [56-](#)  
[712-005](#) [56-724-005](#) [56-724-003](#) [56-721-005](#) [56-721-002](#) [56-723-005](#) [56-723-003](#) [56-721-015](#) [56-721-013](#) [56-](#)  
[721-012](#) [56-716-003](#) [56-716-008](#) [56-716-005](#) [56-716-004](#) [56-745-005](#) [56-745-003](#) [56-741-012](#) [56-741-013](#) [56-](#)  
[741-015](#) [56-704-003](#) [56-704-005](#) [56-746-005](#) [56-733-003](#) [56-731-003](#) [56-715-008](#) [56-713-005](#) [56-733-004](#) [56-](#)  
[731-004](#) [56-726-004](#) [56-706-004](#) [56-701-003](#) [56-713-022](#) [56-703-005](#) [56-702-008](#) [56-711-042](#)