

# Single Channel Transimpedance Amplifier with Output Multiplexing

## FEATURES

- 220MHz –3dB Bandwidth with 2pF Input Capacitance
- Single-Ended Output
- 74kΩ Transimpedance Gain
- 4.8pA/√Hz Input Current Noise Density at 200MHz (2pF)
- 64nA<sub>RMS</sub> Integrated Input Current Noise Over 200MHz (2pF)
- Linear Input Range 0μA to 30μA
- Overload Current > ±400mA Peak
- Fast Overload Recovery: 1mA in 10ns
- Fast Output MUXing: <50ns
- Single 5V Supply
- 90mW Power Dissipation
- 2V<sub>P-P</sub> Output Swing on 100Ω Load
- 3mm × 3mm, 16-Lead QFN Package
- Output MUX Combines Multiple LTC6560 Devices
- AEC-Q100 Qualified for Automotive Applications

## APPLICATIONS

- LIDAR Receiver
- Industrial Imaging

## DESCRIPTION

The LTC<sup>®</sup>6560 is a low-noise, transimpedance amplifier (TIA) with 220MHz bandwidth. The LTC6560's low noise, high transimpedance and low power dissipation are ideal for LIDAR receivers using avalanche photodiodes (APDs). The LTC6560 features 74kΩ transimpedance gain and 30μA linear input current range. Using an input circuit with a total input capacitance of 2pF, the input current noise density is 4.8pA/√Hz at 200MHz. With lower capacitance, noise and bandwidth improve further. The LTC6560 operates from a single 5V supply and consumes only 90mW. Utilizing the LTC6560's output MUX, multiple LTC6560 devices can be combined to a single output. The LTC6560's fast overload recovery and fast output MUXing make it well suited for LIDAR receivers with multiple APDs. Its single-ended output can swing 2V<sub>P-P</sub> on a 100Ω load. Its low impedance op amp style output has been designed to drive back-terminated 50Ω cables.

The LTC6560 is packaged in a compact 3mm × 3mm 16-pin leadless QFN package with an exposed pad for thermal management and low inductance.

All registered trademarks and trademarks are the property of their respective owners.

## TYPICAL APPLICATION

Typical Application with DC-Coupled Inputs Driving a Time-to-Digital Converter with Back-Terminated Cable

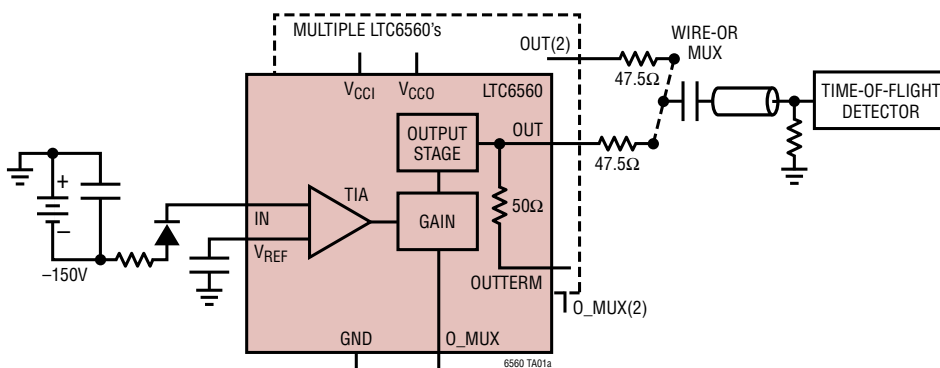

Pulse Response at the Edge of the Overload Region (40μA)

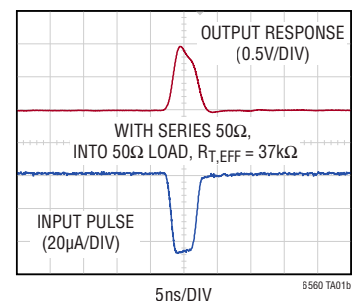

# LTC6560

## ABSOLUTE MAXIMUM RATINGS

(Note 1)

Total Supply Voltage ( $V_{CCI}$ , $V_{CCO}$ to GND)	5.5V
Voltage ( $O\_MUX$ )	-0.3V to 5.5V
Amplifier Reference Current ( $V_{REF}$ )	$\pm 10\text{mA}$
Voltage ( $V_{REF}$ )	-0.3V to 3.5V
Amplifier Input	
Current (IN)	$\pm 400\text{mA}_{RMS}$ $\pm 2\text{A}$ Transient (10ns)
Amplifier Output Current (OUT, OUTTERM)	+80mA
Operating Temperature Range	
LTC6560I (Note 2)	-40°C to 85°C
LTC6560H (Note 3)	-40°C to 125°C
Storage Temperature Range	-65°C to 150°C
Junction Temperature	150°C

## PIN CONFIGURATION

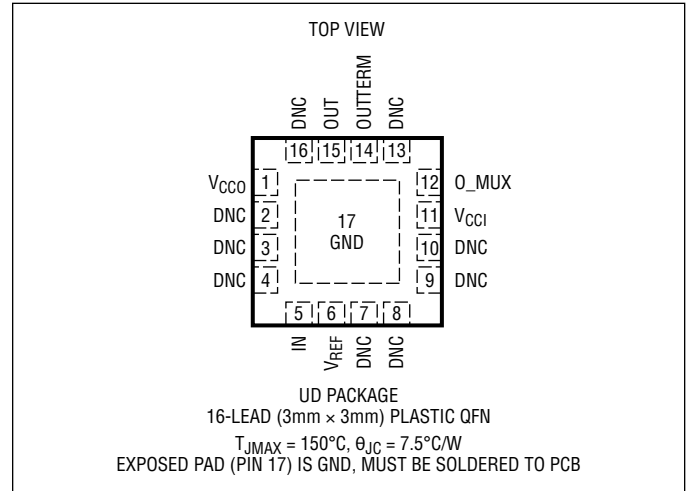

## ORDER INFORMATION

LEAD FREE FINISH	TAPE AND REEL	PART MARKING*	PACKAGE DESCRIPTION	TEMPERATURE RANGE
LTC6560IUD#PBF	LTC6560IUD#TRPBF	LHDV	16-Lead (3mm x 3mm) Plastic QFN	-40°C to 85°C
LTC6560HUD#PBF	LTC6560HUD#TRPBF	LHDV	16-Lead (3mm x 3mm) Plastic QFN	-40°C to 125°C
<b>AUTOMOTIVE PRODUCTS**</b>				
LTC6560HUD#WPBF	LTC6560HUD#WTRPBF	LHDV	16-Lead (3mm x 3mm) Plastic QFN	-40°C to 125°C

Contact the factory for parts specified with wider operating temperature ranges. \*The temperature grade is identified by a label on the shipping container.

[Tape and reel specifications](#). Some packages are available in 500 unit reels through designated sales channels with #TRMPBF suffix.

\*\*Versions of this part are available with controlled manufacturing to support the quality and reliability requirements of automotive applications. These models are designated with a #W suffix. Only the automotive grade products shown are available for use in automotive applications. Contact your local Analog Devices account representative for specific product ordering information and to obtain the specific Automotive Reliability reports for these models.

**AC ELECTRICAL CHARACTERISTICS** The ● denotes the specifications which apply over the full operating temperature range, otherwise specifications are at  $T_A = 25^\circ\text{C}$ ,  $V_{CCI} = V_{CCO} = 5\text{V}$ ,  $O\_MUX = 0\text{V}$ ,  $GND = 0\text{V}$ ,  $R_{LOAD} = 100\Omega$ . Output is AC-coupled. Output taken from OUT pin.

SYMBOL	PARAMETER	CONDITIONS	MIN	TYP	MAX	UNITS
BW	-3dB Bandwidth	$200\text{mV}_{P-P,OUT}$ and $C_{IN,TOT} = 2\text{pF}$		220		MHz
$R_T$	Small Signal Transimpedance	$I_{IN} < 2\mu\text{A}_{P-P}$	63 47.7	74	85 101	$\text{k}\Omega$ $\text{k}\Omega$
$R_{IN}$	Input Resistance	$f = 100\text{kHz}$		236		$\Omega$
$R_{OUT}$	Output Resistance	$f = 100\text{kHz}$		3		$\Omega$
$I_N$	Input Current Noise Density	$f = 100\text{MHz}$ , $C_{IN,TOT} = 2\text{pF}$		4.3		$\text{pA}/\sqrt{\text{Hz}}$
		$f = 200\text{MHz}$ , $C_{IN,TOT} = 2\text{pF}$		4.8		$\text{pA}/\sqrt{\text{Hz}}$
	Integrated Input Current Noise	$f = 0.1\text{MHz}$ to $100\text{MHz}$ , $C_{IN,TOT} = 2\text{pF}$		43		$\text{nA}_{RMS}$
		$f = 0.1\text{MHz}$ to $200\text{MHz}$ , $C_{IN,TOT} = 2\text{pF}$		64		$\text{nA}_{RMS}$
	Channel Isolation	$f = 100\text{MHz}$ ( $O\_MUX = \text{High}$ )		-65		dB
$t_{RECOVER}$	Overload Recovery Time	Input Pulse = 1mA		10		ns
$t_{SWITCH}$	$O\_MUX$ Switchover Time			50		ns

**DC ELECTRICAL CHARACTERISTICS** The ● denotes the specifications which apply over the full operating temperature range, otherwise specifications are at  $T_A = 25^\circ\text{C}$ ,  $V_{CC1} = V_{CC0} = 5\text{V}$ ,  $O\_MUX = 0\text{V}$ ,  $\text{GND} = 0\text{V}$ ,  $R_{\text{LOAD}} = 100\Omega$ . Output is AC-coupled. Output taken from OUT pin.

SYMBOL	PARAMETER	CONDITIONS	MIN	TYP	MAX	UNITS	
<b>IN Pin and <math>V_{\text{REF}}</math> Pin</b>							
$V_{\text{IN}}$	Input Bias Voltage	Active Channel	●	1.43	1.55	1.64	V
				1.25		1.76	V
		Inactive Channel	●	0.78	0.93	1.38	V
				0.70		1.53	V
$V_{\text{REF}}$	Input Reference Voltage	Active Channel		1.43	1.55	1.63	V
		Inactive Channel		1.34	1.50	1.67	V
Offset	$V_{\text{IN}} - V_{\text{REF}}$	Active Channel		-12		12	mV
<b>OUT Pin</b>							
$V_{\text{OUT}}$	Output Default Voltage	$O\_MUX = 0\text{V}$ (Output Enabled)	●	0.83	1.10	1.47	V
				0.79		1.67	V
		$O\_MUX = 3.3\text{V}$ , Standalone Device	●	0.32	0.60	0.88	V
				0.28		0.92	V
OVR	Output Voltage Range	$I_{\text{IN}}$ Current Range = $0\mu\text{A}$ to $-50\mu\text{A}$	●	1.22	1.90	2.58	$V_{\text{P-P}}$
				0.98		2.80	$V_{\text{P-P}}$
$R_{\text{OUTTERM}}$	Internal Series Resistor	Measured at OUTTERM		44	50	70.8	$\Omega$
<b><math>O\_MUX</math> Pin with Internal Pull-Down Resistors</b>							
$V_{\text{IL}}$					0.7	V	
$V_{\text{IL}}$				1.5		V	
$I_{\text{IL}}$	Pin Voltage = 0.7V		●	16.9	20.7	26.0	$\mu\text{A}$
				15.4		28.0	$\mu\text{A}$
$I_{\text{IH}}$	Pin Voltage = 1.5V		●	37	47	57	$\mu\text{A}$
				34		62	$\mu\text{A}$
$C_{\text{IN}}$	Input Capacitance			1.5		pF	
$R_{\text{IN}}$	Input Resistance		●	22	29	35	$\text{k}\Omega$
				21		37	$\text{k}\Omega$
<b>Power Supply</b>							
$V_{\text{S}}$	Operating Supply Range	$V_{\text{CC1}}, V_{\text{CC0}}$		4.75	5	5.25	V
$I_{\text{S}}(V_{\text{CC1}})$	Input Supply Current	$V_{\text{CC1}} = 5\text{V}$	●	12.0	16	20.0	mA
				11.0		21.0	mA
$I_{\text{S}}(V_{\text{CC0}})$	Output Supply Current	$V_{\text{CC0}} = 5\text{V}$	●	1.8	2.3	2.8	mA
				1.7		2.9	mA
$I_{\text{S}}$	Total Supply Current ( $I_{\text{S}}(V_{\text{CC1}}) + I_{\text{S}}(V_{\text{CC0}})$ )		●	13.8	18.3	22.8	mA
				12.7		23.9	mA
$\text{PSRR}(V_{\text{CC1}})$	Input Power Supply Rejection Ratio	$V_{\text{CC1}} = 4.75\text{V}$ to $5.25\text{V}$ , $V_{\text{CC0}} = 5\text{V}$	●	21	25		dB
				15			dB
$\text{PSRR}(V_{\text{CC0}})$	Output Power Supply Rejection Ratio	$V_{\text{CC0}} = 4.75\text{V}$ to $5.25\text{V}$ , $V_{\text{CC1}} = 5\text{V}$	●	34	40		dB
				33			dB

**Note 1:** Stresses beyond those listed under Absolute Maximum Ratings may cause permanent damage to the device. Exposure to any Absolute Maximum Rating condition for extended periods may affect device reliability and lifetime.

**Note 2:** The LTC6560I is guaranteed to meet specified performance from  $-40^\circ\text{C}$  to  $85^\circ\text{C}$ .

**Note 3:** The LTC6560H is guaranteed to meet specified performance from  $-40^\circ\text{C}$  to  $125^\circ\text{C}$ .

# TYPICAL PERFORMANCE CHARACTERISTICS

**I<sub>SUPPLY</sub> vs V<sub>SUPPLY</sub> Over Temperature**

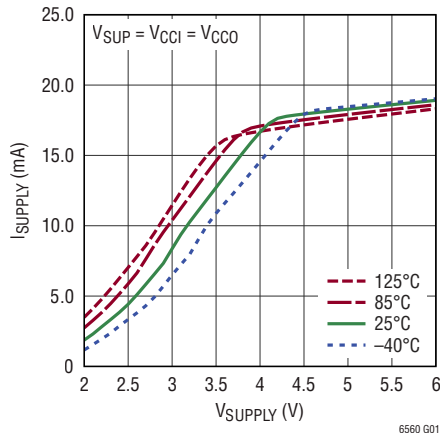

**I<sub>CCI</sub> vs V<sub>CCI</sub> Over Temperature**

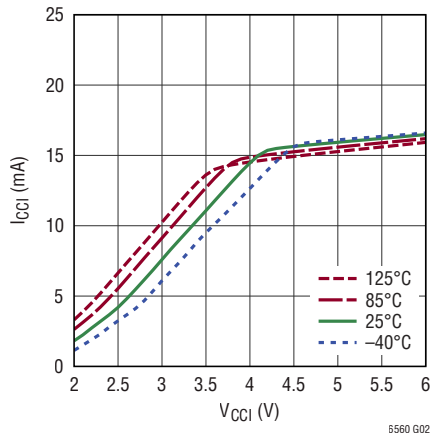

**I<sub>CCO</sub> vs V<sub>CCO</sub> Over Temperature**

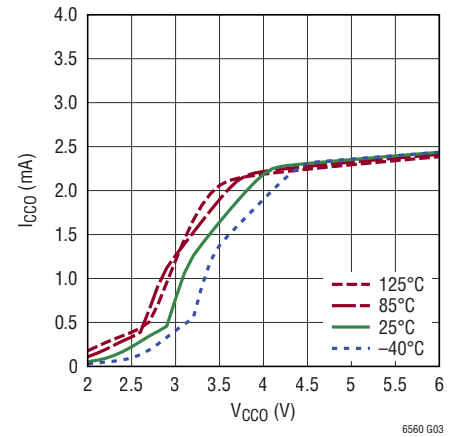

**V<sub>IN</sub> vs Temperature**

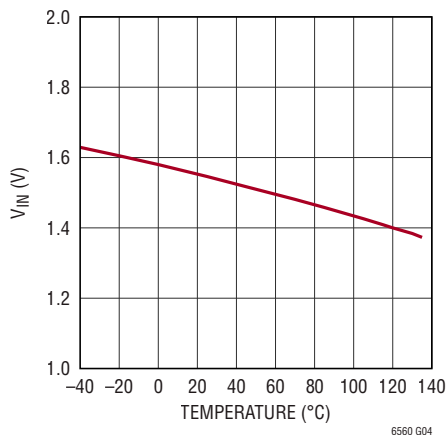

**V<sub>REF</sub> vs Temperature**

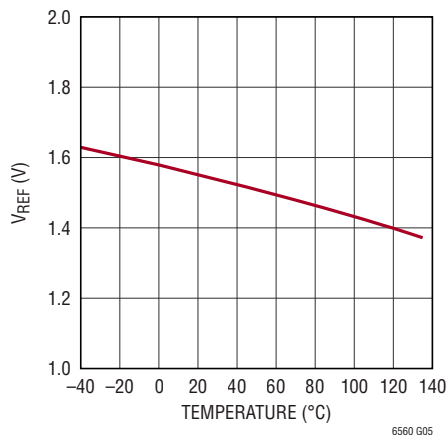

**V<sub>IN</sub> - V<sub>REF</sub> Offset vs Temperature**

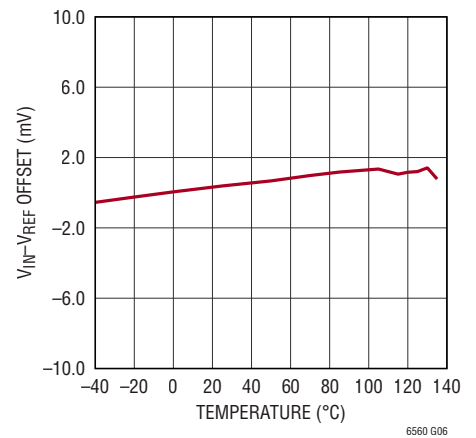

**R<sub>IN</sub> vs Temperature**

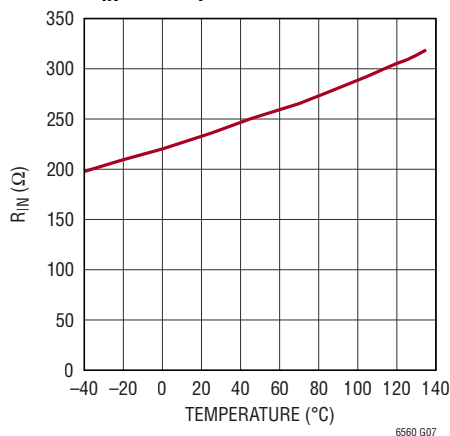

**R<sub>T</sub> Transimpedance vs Temperature**

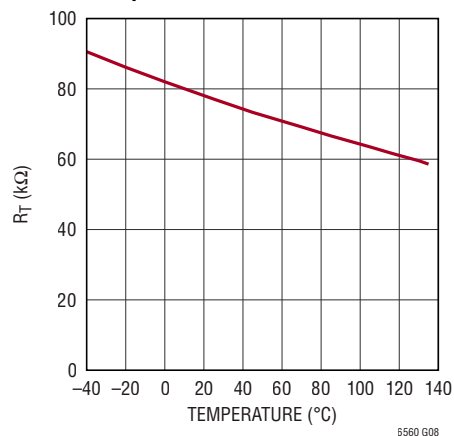

TYPICAL PERFORMANCE CHARACTERISTICS

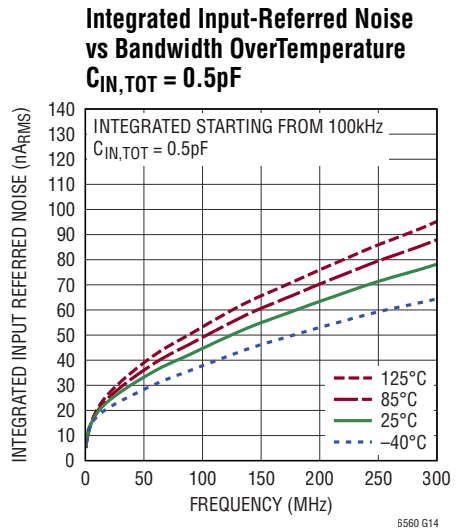
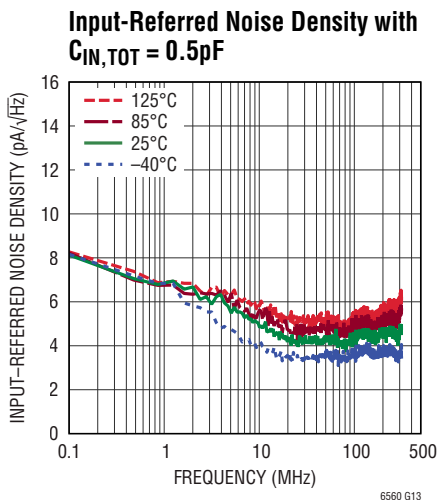
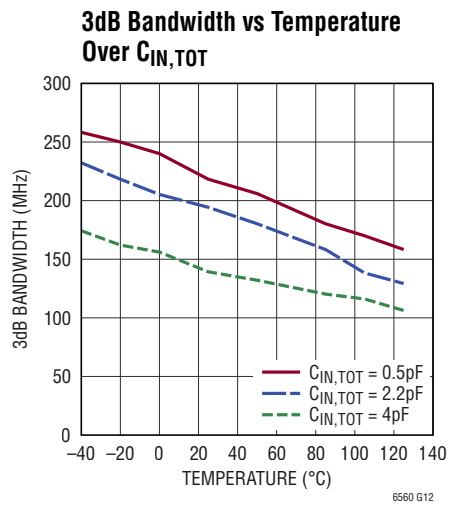
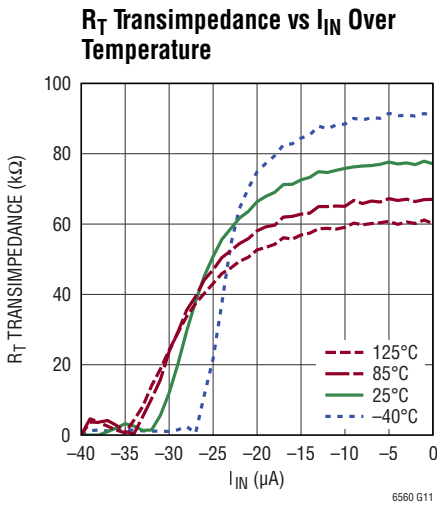
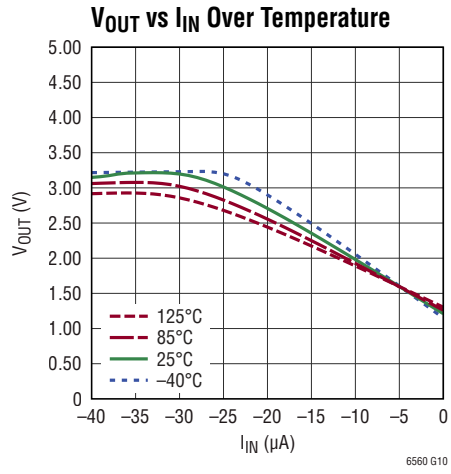
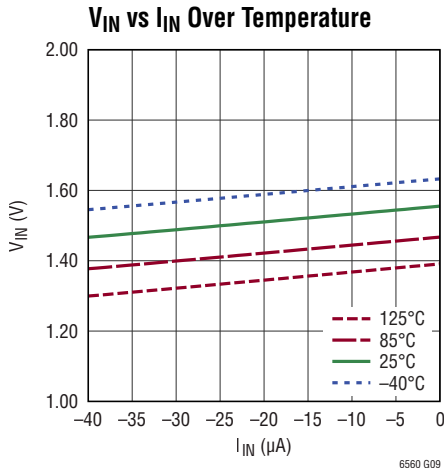

# TYPICAL PERFORMANCE CHARACTERISTICS

**Input-Referred Noise Density with  $C_{IN,TOT} = 2.0pF$**

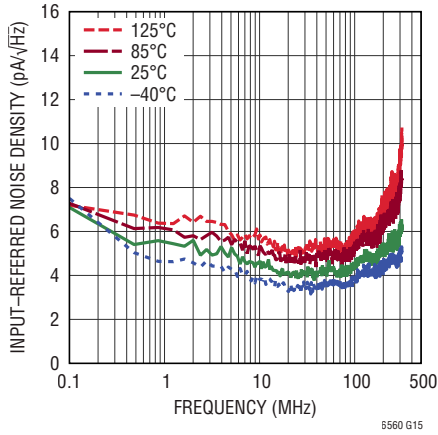

**Integrated Input-Referred Noise vs Bandwidth Over Temperature  $C_{IN,TOT} = 2.0pF$**

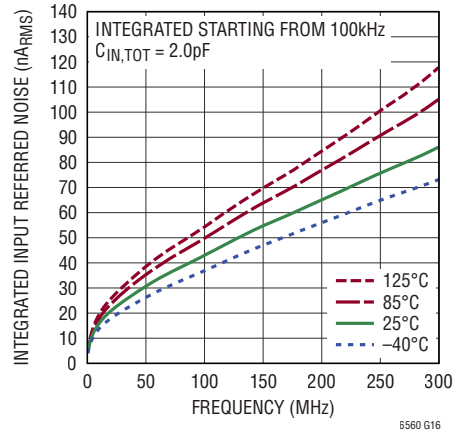

**Input-Referred Noise Density with  $C_{IN,TOT} = 4.0pF$**

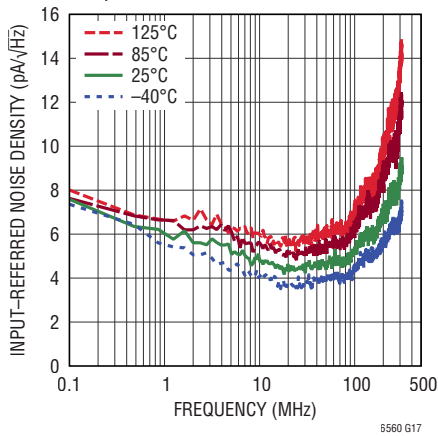

**Integrated Input-Referred Noise vs Bandwidth Over Temperature  $C_{IN,TOT} = 4.0pF$**

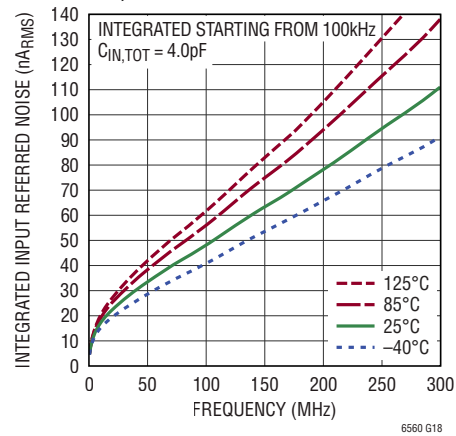

**PSRR OUT to  $V_{CCI}$ ,  $V_{CCO}$**

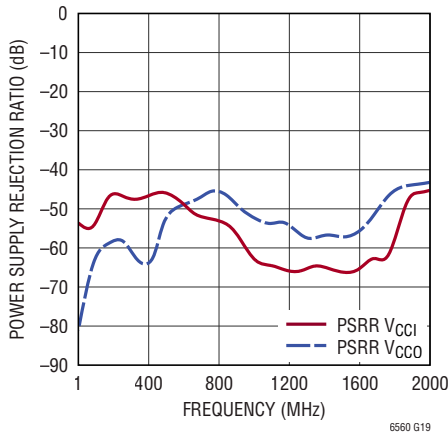

**O\_MUX Isolation vs Frequency Over Temperature**

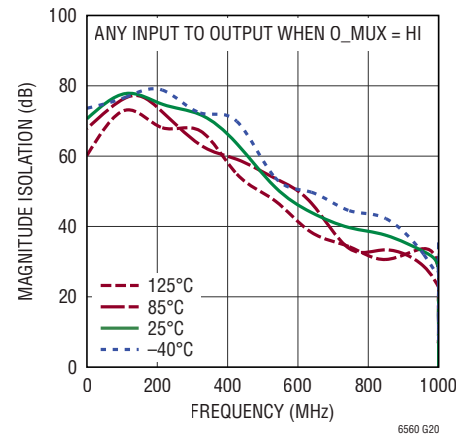

TYPICAL PERFORMANCE CHARACTERISTICS USING DC2807

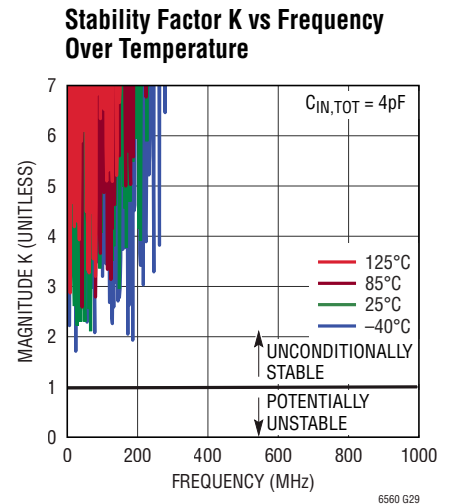
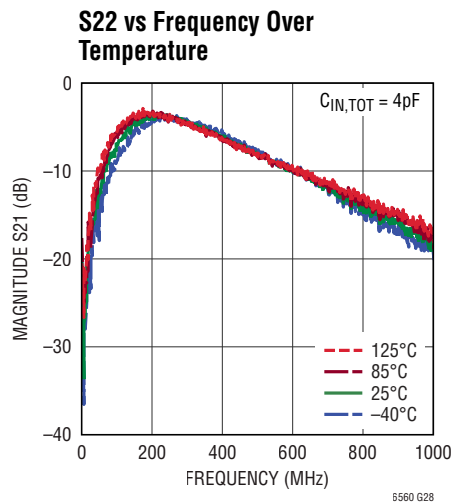
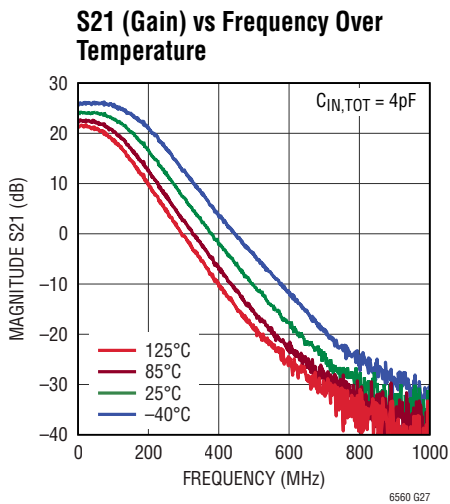
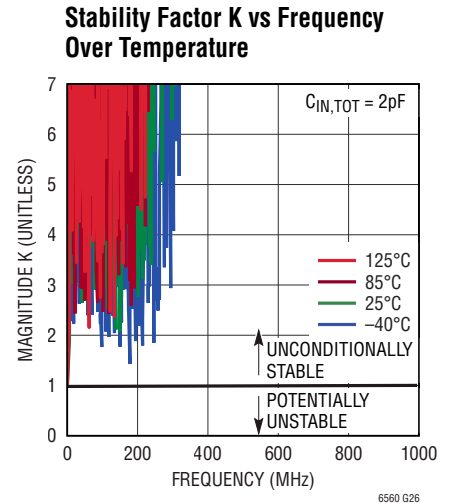
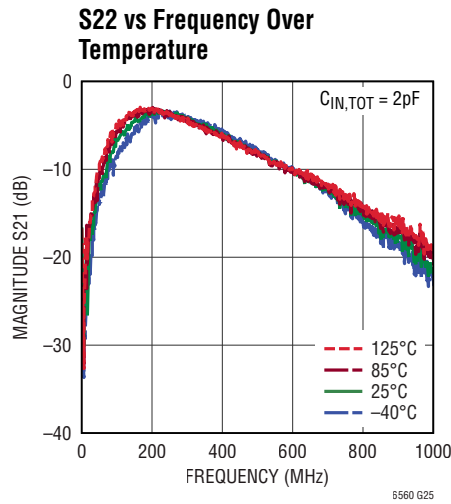
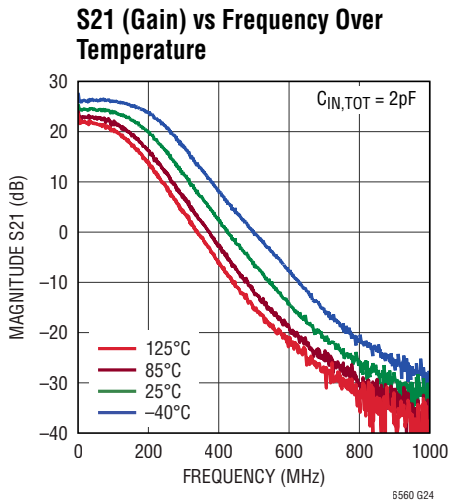
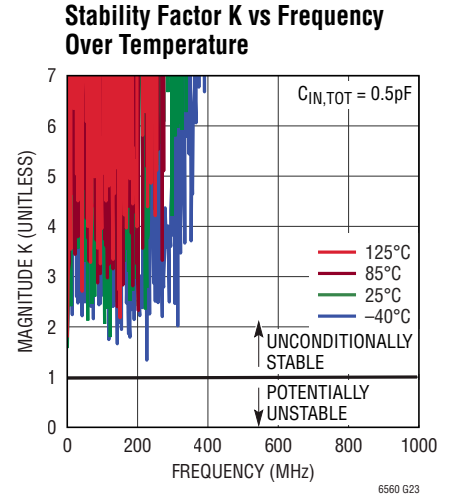
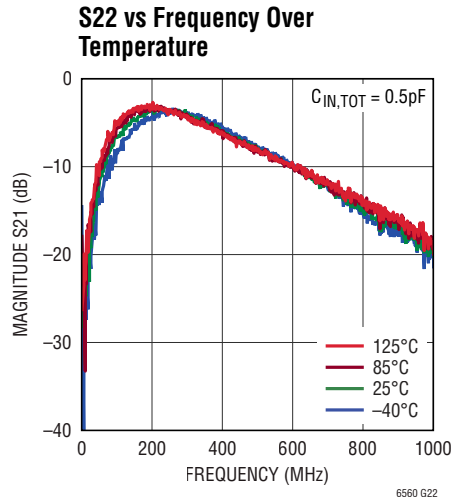
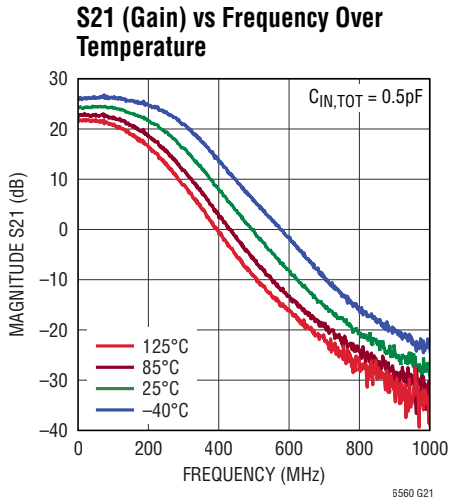



# TYPICAL PERFORMANCE CHARACTERISTICS

**Pulse Response Linear Range  
(2.5µA)**

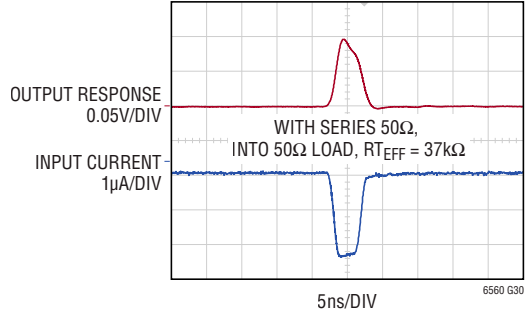

**Pulse Response Linear Range  
(20µA)**

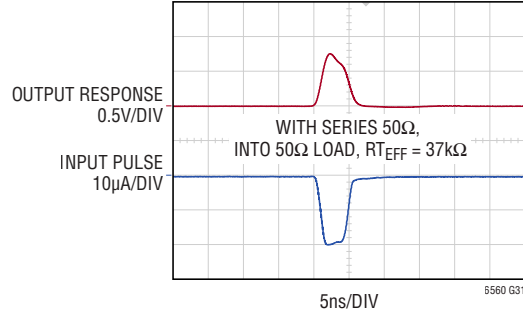

**Pulse Response Overload Range  
(40µA)**

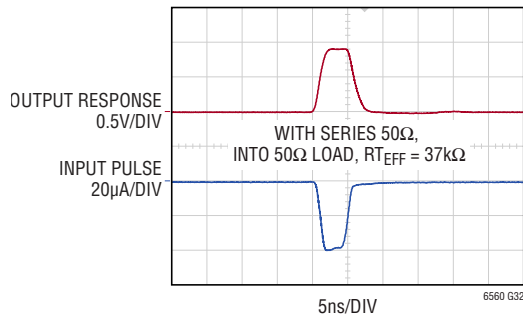

**Pulse Response Overload Region  
(1mA)**

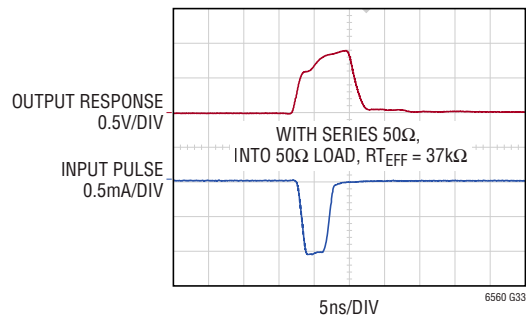

**O\_MUX Switching Time  
DC Coupled Input**

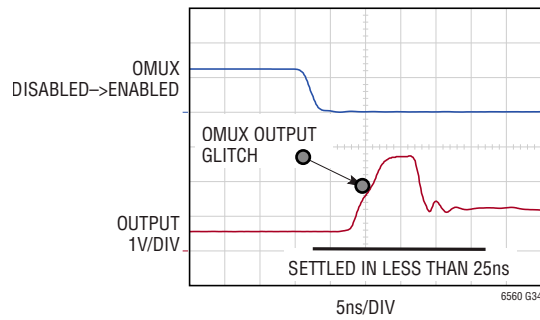

**O\_MUX and Channel Switching  
Time for AC Coupled Input**

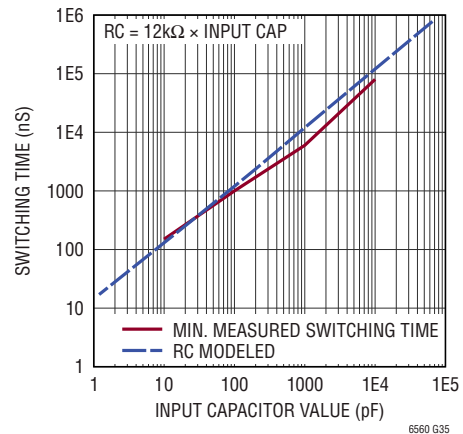

**TYPICAL PERFORMANCE CHARACTERISTICS USING DC2807**

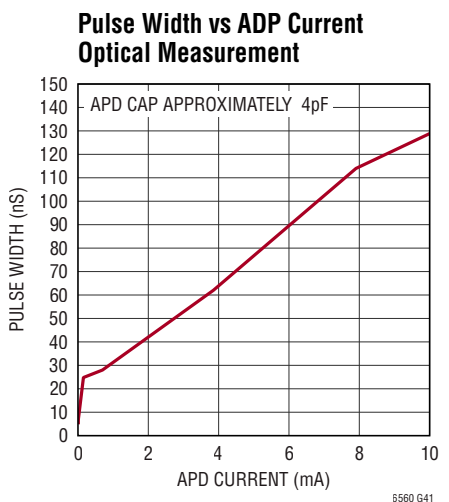
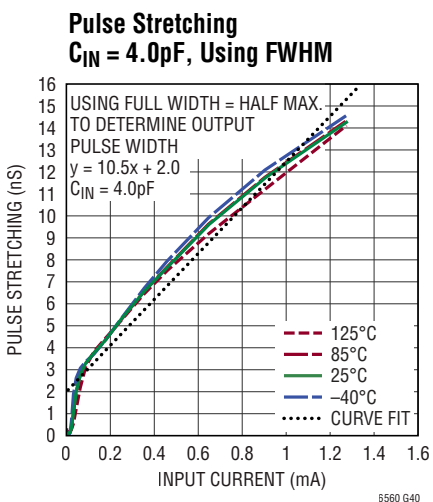
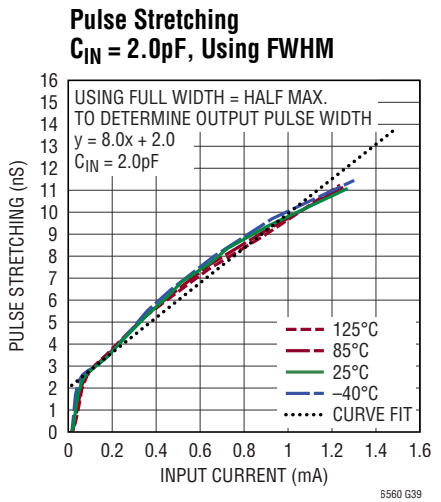
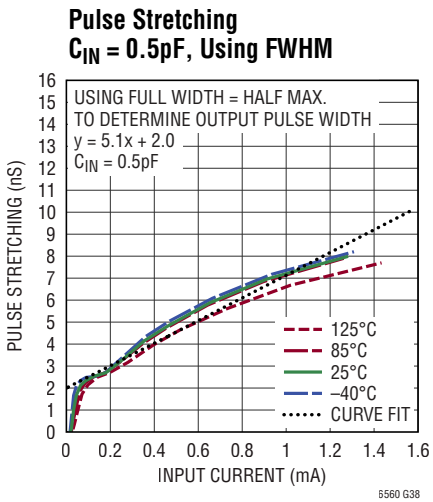
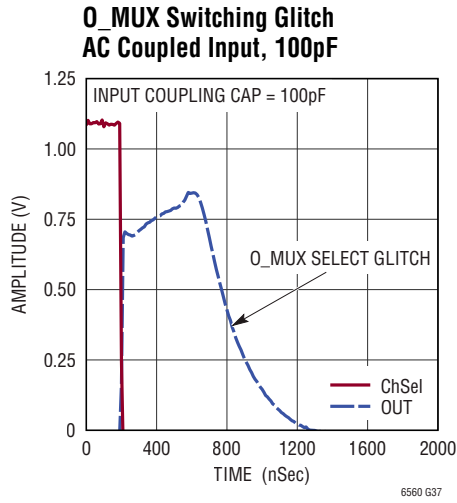
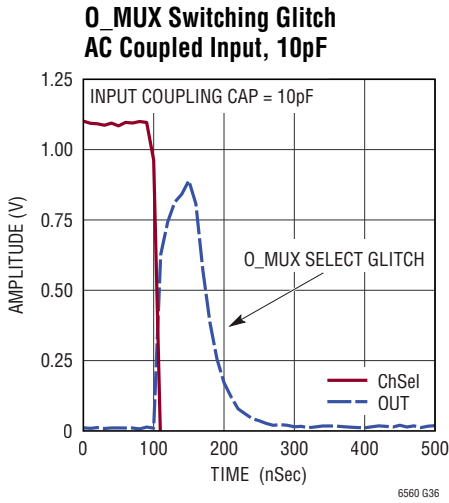

## PIN FUNCTIONS

**V<sub>CC0</sub> (Pin 1):** Positive Power Supply for the Output Stage. Typically, 5V. V<sub>CC0</sub> can be tied to V<sub>CC1</sub> for single supply operation. Bypass capacitors of 1000pF and 0.1μF should be placed as close as possible between V<sub>CC0</sub> and ground.

**DNC (Pins 2 to 4, 7 to 10, 13, 16):** Do not connect these pins. Allow them to float.

**IN (Pin 5):** Input Pin for Transimpedance Amplifier. This pin is internally biased to 1.55V when the channel is active. See the Applications section for specific recommendations.

**V<sub>REF</sub> (Pin 6):** Reference Voltage Pin for TIA. This pin sets the input DC voltage for the TIA. The V<sub>REF</sub> pin should be bypassed with a high quality ceramic bypass capacitor of at least 0.1μF. The bypass cap should be located close to the V<sub>REF</sub> pin. The V<sub>REF</sub> pin has a Thevenin equivalent resistance of approximately 1.4k and can be overdriven by an external voltage. If no voltage is applied to V<sub>REF</sub>, it will float to a default voltage of approximately 1.55V on a 5V supply when active.

**V<sub>CC1</sub> (Pin 11):** Positive Power Supply for the Input Stage. Typically 5V. Bypass capacitors of 1000pF and 0.1μF should be placed as close as possible between V<sub>CC1</sub> and ground.

**O\_MUX (Pin 12):** Output MUX is a digital input controlling the output multiplexing function. The pin is functional when multiple LTC6560s are combined at the output. When O\_MUX is low, the output is enabled. When O\_MUX is high, the input is decoupled from the output. Its default value is 0V. This MUX pin is ineffective unless a second LTC6560 is DC-coupled at the output. See Applications section on how to use O\_MUX to expand the channel count with multiple LTC6560's. The O\_MUX pin has a 29kΩ internal pull-down resistor.

**OUTTERM (Pin 14):** TIA Output with an Internal Series 50Ω Resistor.

**OUT (Pin 15):** TIA Output without an Internal Series 50Ω Resistor.

**GND (Exposed Pad Pin 17):** Negative Power Supply. Normally tied to ground. The exposed pad (pin 17) should have multiple via holes to an underlying ground plane for low inductance and good heat transfer.

## BLOCK DIAGRAM

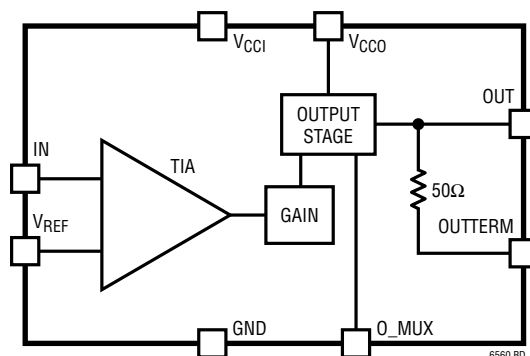

## OPERATION

The LTC6560 is a transimpedance amplifier with output MUXing. A transimpedance amplifier converts an input current to an output voltage. The output multiplexer capability (O\_MUX) allows multiple single channel LTC6560 devices to be combined. For example 2, 4, 6 or 8 current input channels are easily multiplexed into a single voltage output.

In typical LIDAR applications, the LTC6560 amplifies the output current of an APD. APDs are biased near breakdown to achieve high current gain. Under intense optical illumination they can conduct large currents, often in excess of 1A. The LTC6560 survives and quickly recovers from large overload currents of this magnitude. Rapid overload recovery is critical for LIDAR applications. During recovery, any TIA is blinded from subsequent pulses. The LTC6560 recovers from 1mA saturation events in less than 12ns without phase reversal, minimizing this form of

data loss. As the level of input current exceeds the linear range, the output pulse width will widen. However, the recovery time remains in the 10's of ns. See Figure 10 and Figure 11 plots of pulse stretching versus input current.

Internally the LTC6560 consists of multiple stages. The first stage is a transimpedance amplifier. A second voltage gain stage leads to a final output buffer that can drive a  $2V_{P-P}$  swing into a  $100\Omega$  load.

To increase a LIDAR system's spatial resolution, many APDs are deployed, often in an array. To achieve maximum bandwidth, each APD pixel must have a dedicated TIA, as increasing  $C_{IN}$  will reduce bandwidth. The LTC6560 output multiplexing capability allows compact multichannel designs without external multiplexers. The use of multiple LTC6560s works well with multiple single APDs to minimize trace capacitance, cost and solution size.

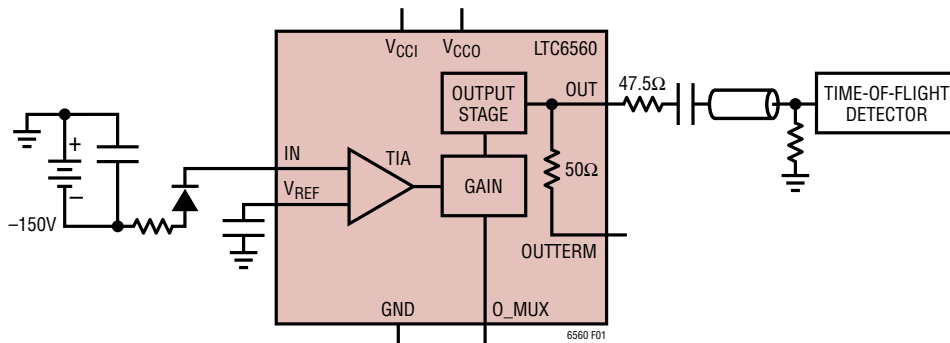

Figure 1. Single LTC6560 with DC-Coupled Inputs Driving a TDC with Back-Terminated Cable

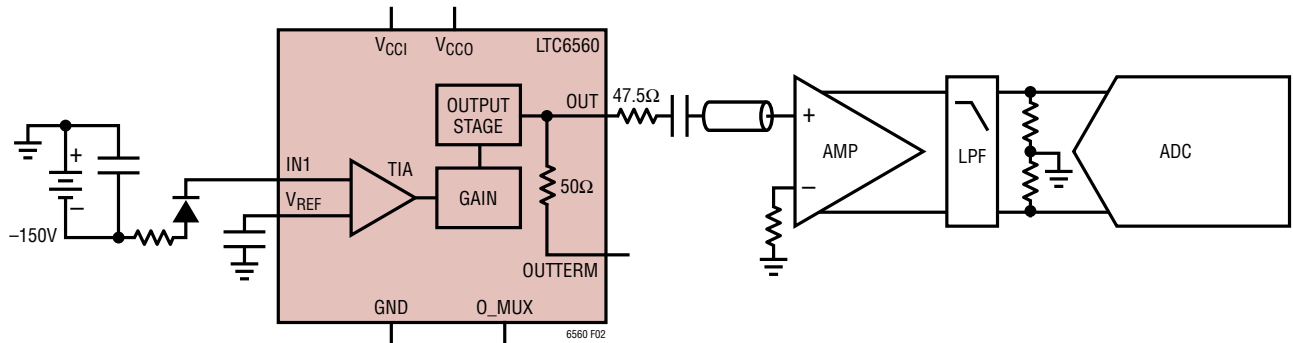

Figure 2. Typical Application with Output to an ADC

## APPLICATIONS INFORMATION

### External Bypassing

The LTC6560 has separate supply pins for input ( $V_{CCI}$ ) and output ( $V_{CCO}$ ), both of which should be bypassed with 1000pF and 0.1 $\mu$ F capacitors to ground. For simplest operation, the input and output supplies should be set to the same voltage.

The LTC6560 has a small internal bypass capacitor connected between the  $V_{REF}$  pin and ground to ensure low input noise. For the lowest possible input noise, the  $V_{REF}$  pin should also be bypassed externally with a high quality 0.1 $\mu$ F ceramic capacitor to ground. This bypass cap should be located physically close the  $V_{REF}$  pin.

### AC or DC Input-Coupling: Design Tradeoffs

Coupling the APD to the TIA is a critical design aspect with many tradeoffs to consider. A DC coupled input is the simplest, requiring minimal components to directly couple the APD to the TIA. In the DC case, switching times are fast <50ns and saturation recovery times are minimized. However, this method does not reject APD dark current, and ambient light components. These DC components can diminish the TIA's dynamic range. External DC current cancellation can be used to restore the TIA's dynamic

range by injecting current at the TIA input to offset the APD's DC current components. Care must be taken at the TIA's input as current injection can also inject noise.

### AC Coupling the Input

Recommended values for AC coupling are shown in Table 1. An AC coupled input will block all DC inputs, preserving the TIA's full dynamic range. See Figure 3. However, switching times will degrade depending on the choice of AC coupling capacitor. When a channel is switched from inactive to active using the O\_MUX control, a glitch will appear at the output. See Figure 5 and Figure 6. The TIA will not be ready for a desired input pulse until the glitch has settled. The glitch settling time is dependent upon the AC coupling capacitor value. The value of the AC coupling cap must be carefully considered. A plot of switching times vs. coupling capacitor is shown in Figure 4.

An AC coupling capacitor will also degrade the saturation recovery of any TIA. When an overload occurs at the TIA input, the voltage will be yanked low. Recovery will occur when the input voltage reestablishes its pre-saturation value.

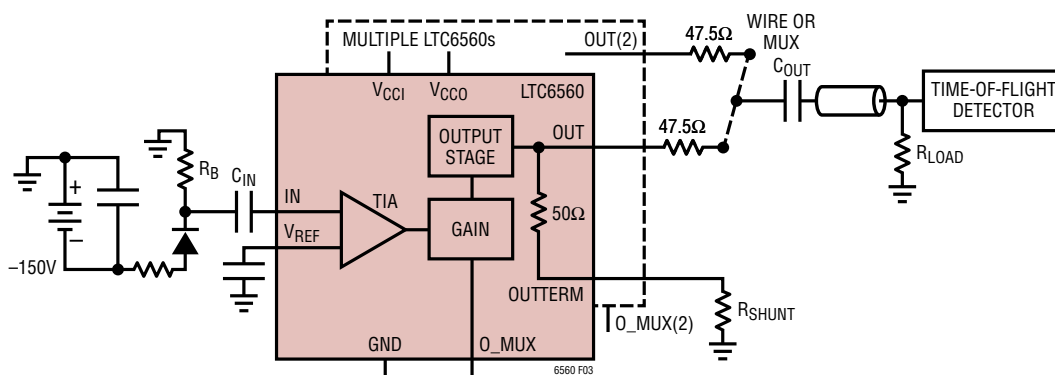

Figure 3. LTC6560 with AC Coupled Input and Output

Table 1. 6560 Suggested Values for Repetition Rates less than 100kHz\*

Check with Applications Support for AC coupling at higher rep rates.

COMPONENT	DC IN/DC OUT	DC IN/AC OUT	AC IN/ DC OUT	AC IN/AC OUT
Input AC Cap— $C_{IN}$	SHORT	SHORT	100pF	100pF
ADP Bias— $R_B$	OPEN	OPEN	2.2k $\Omega$	2.2k $\Omega$
Output AC Cap— $C_{OUT}$	SHORT	1000pF	SHORT	1000pF
Output DC Sink— $R_{SHUNT}$	OPEN	1k $\Omega$	OPEN	1k $\Omega$

\*DC Coupled I/O are capable of much faster repetition rates.

APPLICATIONS INFORMATION

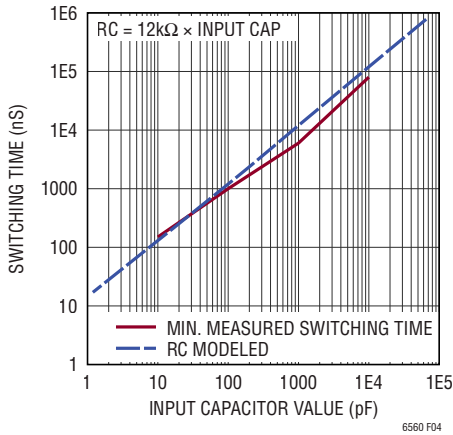

Figure 4. O\_MUX Switching Time vs AC Coupling Capacitor Value

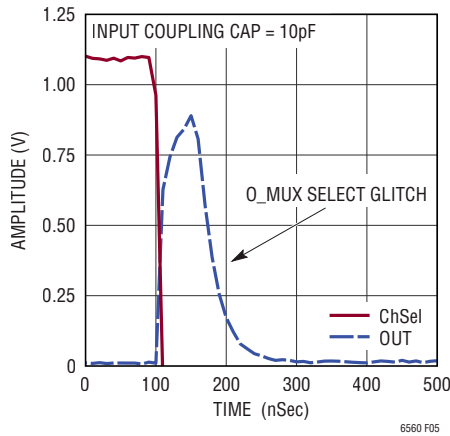

Figure 5. O\_MUX Glitch 10pF

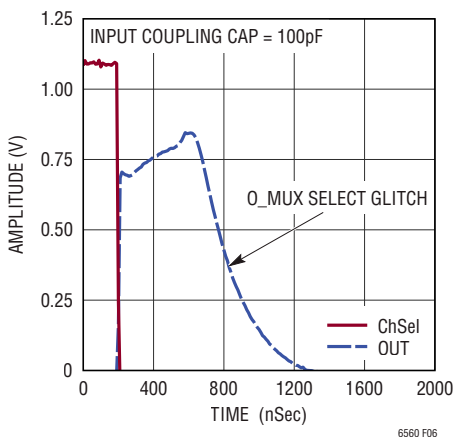

Figure 6. O\_MUX Glitch 100pF

During recovery, the input capacitor must be recharged through the TIA’s internal resistor and  $R_B$ . The input cap and  $R_B$  must be carefully chosen so that the recharge time constant is acceptable.

To maximize dynamic range, the LTC6560’s input is limited to negative current pulses (current flowing out of the LTC6560). When using a negatively biased APD, the TIA input can be AC or DC coupled to the APD cathode. When using a positively biased APD, the input must be AC coupled to the APD’s anode.

Output Considerations

The LTC6560’s output stage is a low impedance driver. When using the OUT pin in a 50Ω environment, a series 47.5Ω resistor must be added to match to 50Ω transmission lines and equipment. If the OUTTERM pin is utilized, the 47.5Ω resistor is internal and no external component is needed. OUT and OUTTERM should be not be utilized at the same time. At the single ended output, the quiescent DC voltage is approximately 1.0V. Loaded with 100Ω or higher load, the output can swing to 3V. This is equivalent to a 2V<sub>P-P</sub> swing. If driving a back-terminated 50Ω load, the output will only swing 1V<sub>P-P</sub> since half of the voltage is dropped across the series output resistor (Figure 7).

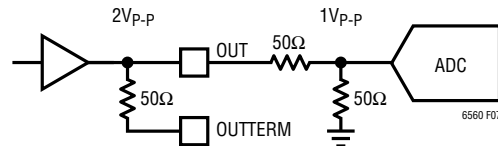

Figure 7. Output Voltage Swing

AC or DC Coupled Output: Design Tradeoffs

The LTC6560 has a class B output stage to save power. It can supply current but has a limited ability to sink current. Therefore, the rising edge of an output pulse will be quite sharp allowing for accurate Time-of-Flight TOF estimation. When the output is DC coupled to a low impedance (100Ω or 50Ω) the output pulse falling edge will also be sharp, and high repetition rates can be supported. However, when the output is AC coupled, the LTC6560’s limited ability to sink current can slow the outputs falling edge. At high pulse repetition rates the apparent  $R_T$  will degrade. At repetition rates >100kHz the left side of the output

## APPLICATIONS INFORMATION

coupling cap (typically 1000pF) will not have time to fully discharge before the next pulse arrives. See Figure 3.

If an AC coupled output is desired, a 1k $\Omega$  resistor should be added to the LTC6560 output. The shunt 1k $\Omega$  resistor will insure fast overload recovery and switching times. For AC coupling, a 1000pF capacitor is recommended as higher cap values will slow O\_MUX switching speed and smaller values could distort the pulse. A shunt 1k $\Omega$  resistor on the LTC6560 output will increase the quiescent current by 1mA while minimally impacting gain and output matching. On the other hand, directly DC coupling the output to a 50 $\Omega$  load will add 10mA of current draw.

If the LTC6560 output is directly terminated into a high impedance load like an oscilloscope, the output falling edge will again be distorted as the LTC6560 has limited ability to sink current. When monitoring the output with an oscilloscope, be sure to set the scope's input termination to 50 $\Omega$ .

### Output MUXing

The output MUX (O\_MUX) feature can be used when multiple LTC6560 share a common DC output connection. The active LTC6560 can be selected by asserting its O\_MUX pin low. The inactive channels must have their O\_MUX pin(s) high. The active LTC6560 effectively overpowers the others, operating in a master/slave relationship. It is recommended to DC couple the outputs after the series 40-50 $\Omega$  resistor as this will limit reflection from unselected outputs. At least one LTC6560 output must be selected at all times. In its default mode O\_MUX is pulled low and the LTC6560 output is enabled. If there is

only one LTC6560, then setting the O\_MUX pin high will not MUX anything; however, the output will be isolated from the input. Using O\_MUX to disable a channel will not reduce power consumption.

### APD Input Capacitance

In high speed TIAs, bandwidth and rise time of the output pulse are a strong function of input capacitance. To receive narrow pulses, a low capacitance APD sensor is recommended. Trace capacitance and parasitic pad capacitance should also be minimized at the input. All LTC6560 plots reference  $C_{IN,TOT}$  which is the total input capacitance including APD sensor, trace routing and parasitics.

Using individual LTC6560's allows the TIA to be placed close to the APD. This provides tidy routing for individual APDs and a compact solution size for APD arrays. Traces should be as short as possible between the APD and the TIA to avoid coupling and to minimize parasitics.

Internal protection circuitry at each TIA input can protect the LTC6560 even under strong overdrive conditions. Most application circuits will not need external protection diodes which add to the total input capacitance and slows the rise time. Output rise time can be estimated from the amplifier bandwidth using the following relationship:

$$\text{Rise Time} = \frac{0.35}{\text{BW}}$$

For an APD with 0.5pF of total input capacitance, the rise time is calculated to be 1.5ns, appropriate for pulses greater than 4ns wide.

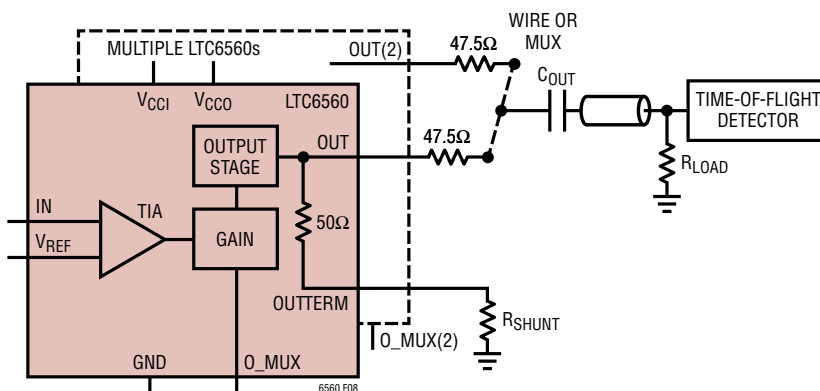

Figure 8. AC Coupled Output

## APPLICATIONS INFORMATION

For an APD with 4pF of total input capacitance, the rise time is calculated to be 2.3ns, appropriate for pulses greater than 6ns wide.

### APD Biasing

Proper APD biasing is key to producing a high-fidelity output and protecting both the APD and TIA. A negatively biased APD generally provides the lowest input capacitance and allows the APD to be DC coupled to the TIA. To keep the optical gain stable the APD bias should be temperature compensated. Quenching resistors in series are required to limit the maximum current, thereby protecting the APD and TIA from damage.

An example of a typical APD bias network is shown in Figure 13. Starting at the negative bias input, two physically large 10kΩ resistors limit the maximum ADP current and filter the HV supply. They are decoupled with a 1nF capacitor. Moving towards the APD, a second smaller quenching resistor 50Ω is decoupled by two 0.047μF capacitors. This smaller quenching resistor acts to dampen ringing especially under high slew rates due to large optical inputs pulses. It can also limit the maximum pulse current. All capacitors must be rated for high voltage as APD bias voltages can run above 200V.

### Dramatically Improving the LTC6560's Dynamic Range

The LTC6560's offers 30μA of linear input range while monitoring the output amplitude. It is possible to dramatically improve the range over which input current can be accurately measured by monitoring pulse width. The measurement range can be increased from 30μA to at least 3mA, a 100x improvement in current measurement range! As the input current exceeds the linear range, the pulse amplitude saturates. In saturation, the output pulse width widens in a predictable monotonic manner (Figure 10).

Monotonic pulse widening can be demonstrated using the DC2807 evaluation board with a DC coupled output. This evaluation board uses a series 2k resistor to convert a voltage pulse into a current pulse, as it is difficult to obtain a fast current generator. The input is terminated to 50Ω so that current pulses with precise amplitude are generated at the TIA input using a voltage

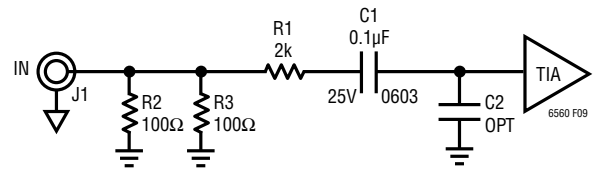

Figure 9.

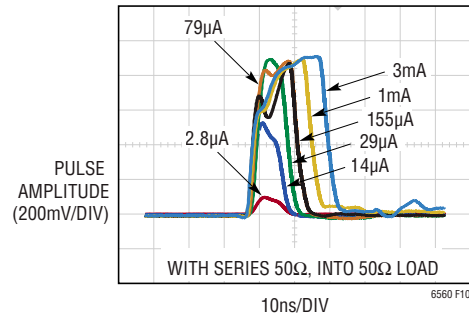

Figure 10. Output Pulse Over Input Current

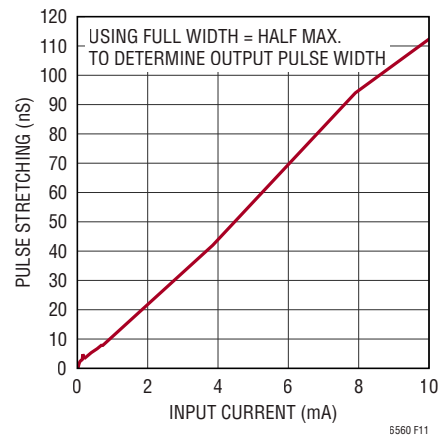

Figure 11. Pulse Stretching T = 25°C, Using FWHM

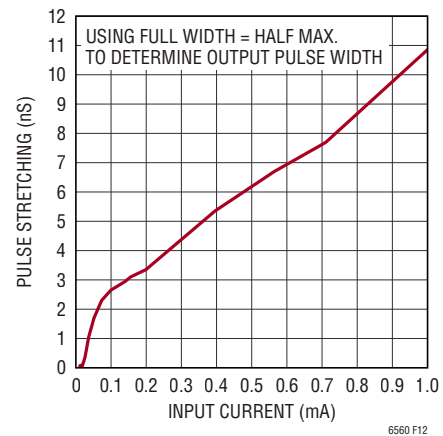

Figure 12. Pulse Stretching Detailed T = 25°C, Using FWHM



## APPLICATIONS INFORMATION

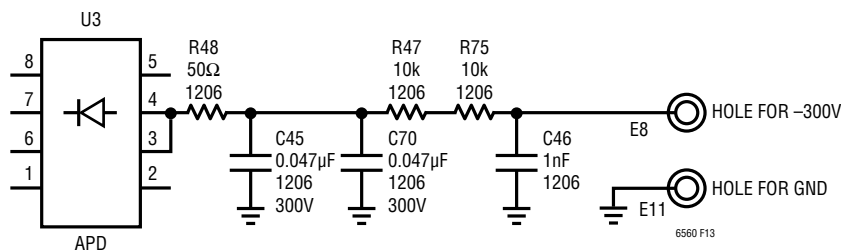

Figure 13. Typical APD Bias Current

source (Figure 9). Sweeping the TIA pulse input current from  $2.8\mu\text{A}$  to  $3\text{mA}$ , we see that as the current surpasses the  $30\mu\text{A}$  linear input range, the pulse width increases (Figure 11 and Figure 12). Figure 12 shows the pulse width stretching in detail (output response width – input pulse width). We observe that the stretching is linearly proportional to the input current. In the linear range up to  $30\mu\text{A}$ , the pulse does not stretch. FWHM (full width half max) criteria was used to measure the pulse width. Pulse output width is taken at half of the maximum swing, usually around  $0.45\text{V}$ . A more sophisticated algorithm could be used to gain greater accuracy assuming the pulse edges are accurately captured by an ADC or TDC.

In the previous example, we used electrical excitation as it is difficult to measure the input pulse current of an APD without disturbing the desired pulse. The LTC6560's pulse stretching has also been demonstrated using the DC2803 optical evaluation board at low to moderate optical input levels. Independently measuring the current generated during an optical pulse impinging on an APD is quite difficult. The parasitics of any measuring device will impair the actual pulse input. Referring to Figure 13, using a balun across series resistor R48 feeding the APD, we can get an independent determination of APD current to the TIA for moderate laser input powers. Again, when this APD current is plotted versus pulse stretching, we find a nearly linear relationship under moderate illumination.

At high optical input powers, the balun degrades the APD input current pulse. A DC2803 optical evaluation circuit without a balun was characterized under high optical input. Using a calibrated laser source, we find that pulse stretching continues even at extremely high laser power levels of 50 Watts. At high illumination levels, the

relationship of input current to pulse stretching no longer appears perfectly linear, (Figure 15) but the potential to measure these high optical power levels appears possible. A calibration of optical input power to pulse stretching should be done as the optical gain is a strong function of the APD reverse bias, temperature and the choice of APD.

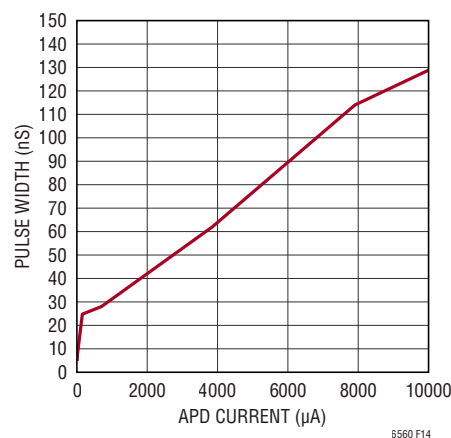

Figure 14. Pulse Width vs APD Current Optical Measurement

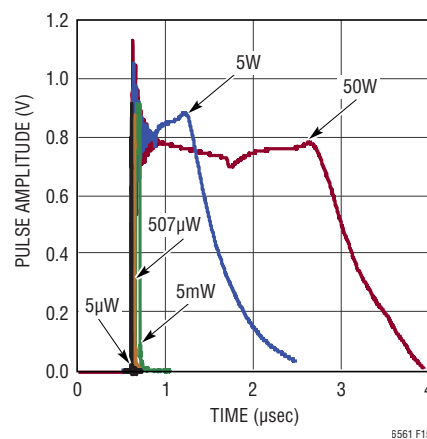

Figure 15. Pulse Width vs Input Hi Power Optical

## APPLICATIONS INFORMATION

Evaluation board DC2807A allows for electrical evaluation using a voltage source to create a current input to the TIA. A 2k series resistor converts the voltage from a voltage pulse generator into a current pulse at the input of the TIA. This board is also compatible with 50Ω test equipment.



Figure 16. DC2807A Single Channel Electrical Evaluation Board

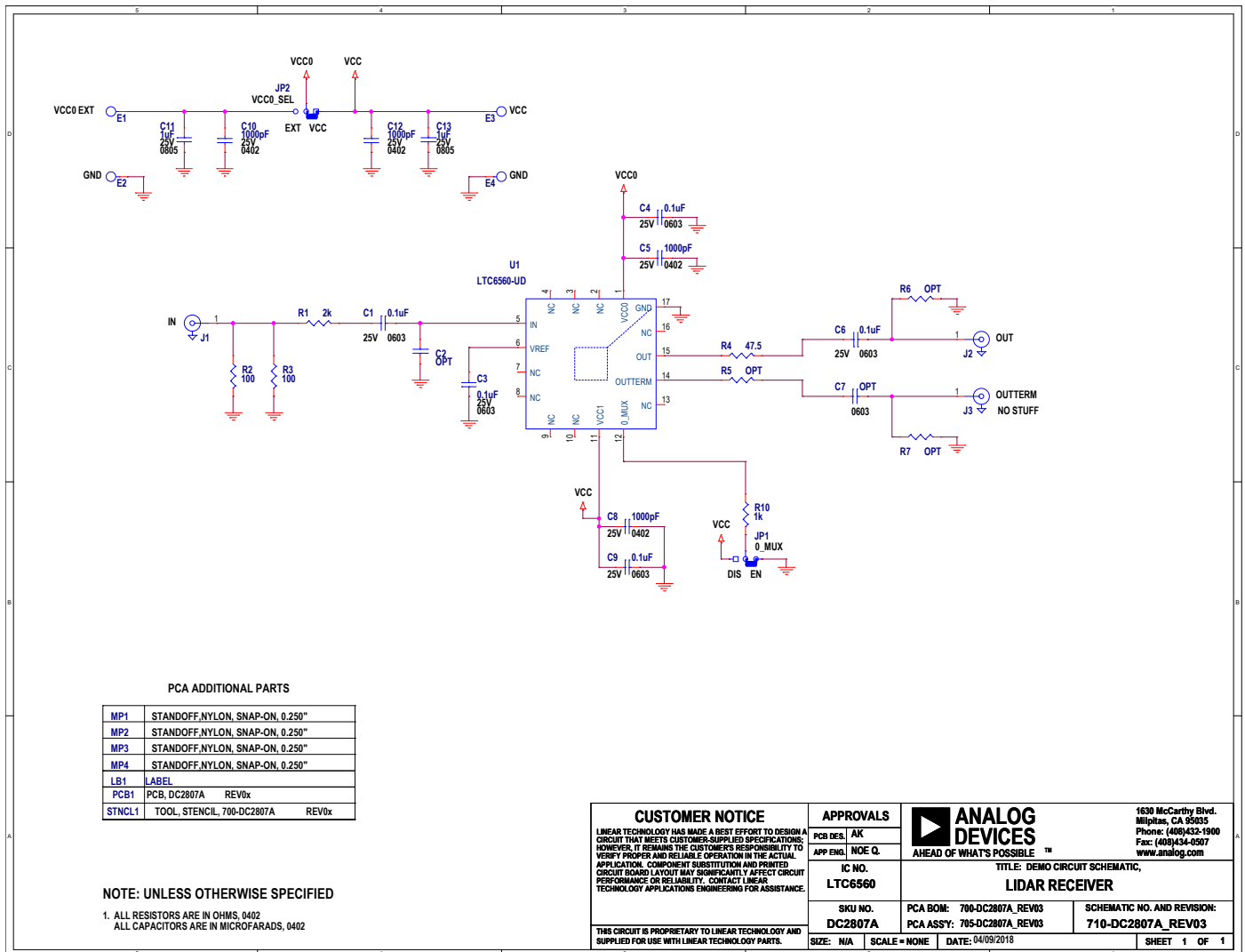

# APPLICATIONS INFORMATION

Evaluation board DC2803A allows for optical evaluation using a laser source. An onboard APD converts an optical pulse into a current pulse that is converted to an

output voltage by the LTC6560. Use of the DC2803 will more closely resemble LIDAR and any other optically driven applications.

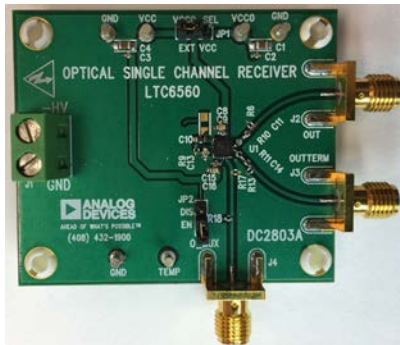

DC2803A Front Side

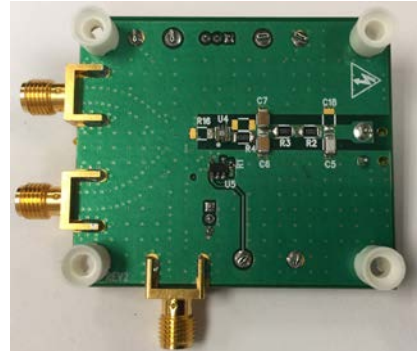

DC2803A Back Side

Figure 17. DC2803A Single Channel Demonstration Circuit for Optical Evaluation

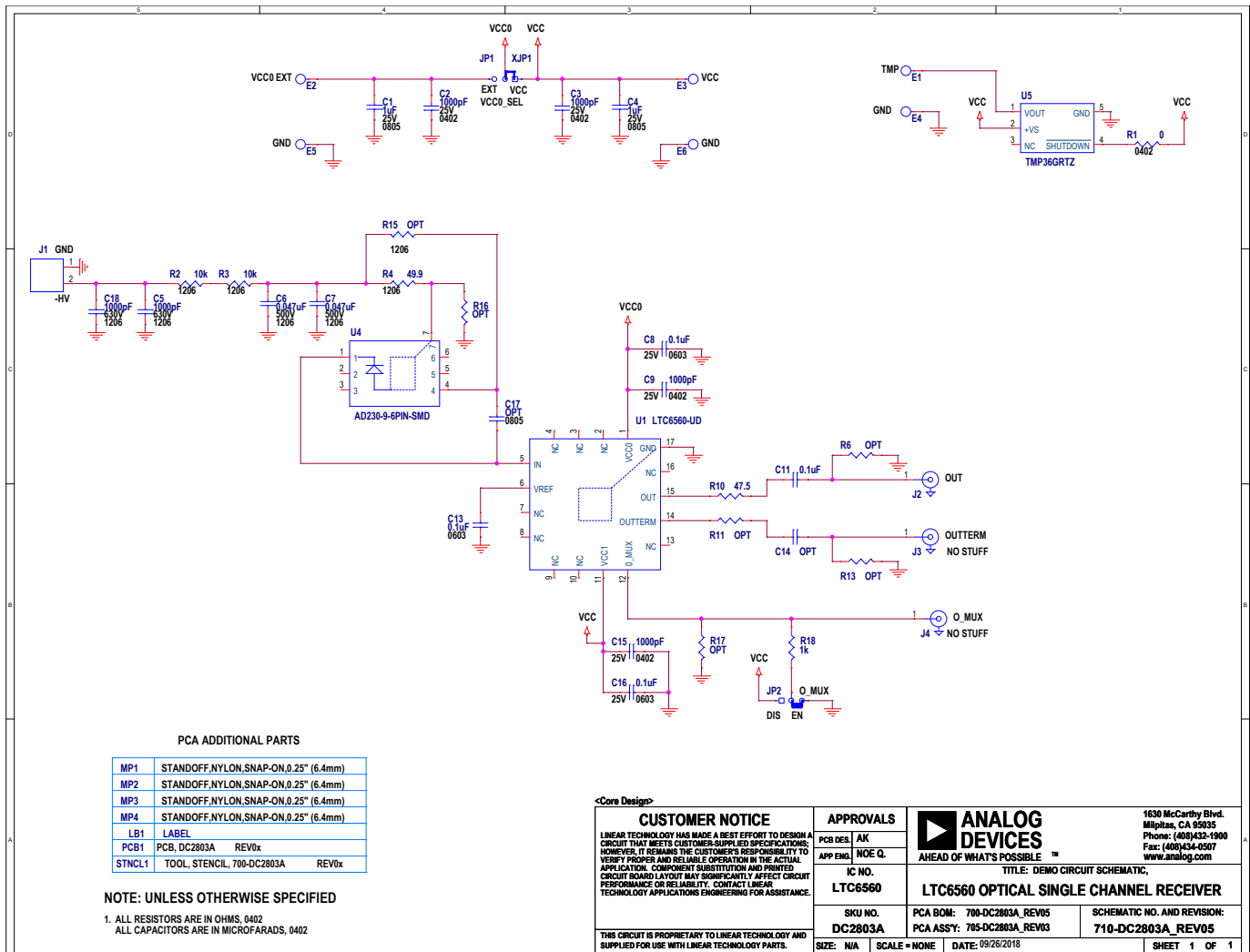

# PACKAGE DESCRIPTION

**UD Package**  
**16-Lead Plastic QFN (3mm × 3mm)**  
 (Reference LTC DWG # 05-08-1700 Rev A)

**Exposed Pad Variation AA**

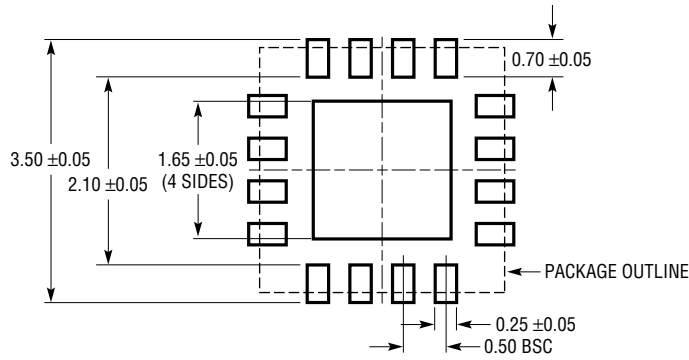

RECOMMENDED SOLDER PAD PITCH AND DIMENSIONS

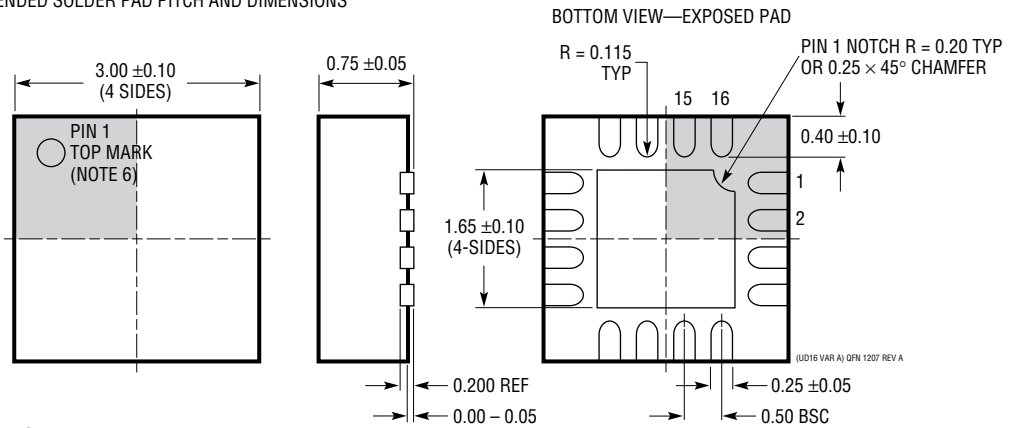

- NOTE:
1. DRAWING CONFORMS TO JEDEC PACKAGE OUTLINE MO-220 VARIATION (WEED-4)
  2. DRAWING NOT TO SCALE
  3. ALL DIMENSIONS ARE IN MILLIMETERS
  4. DIMENSIONS OF EXPOSED PAD ON BOTTOM OF PACKAGE DO NOT INCLUDE MOLD FLASH. MOLD FLASH, IF PRESENT, SHALL NOT EXCEED 0.15mm ON ANY SIDE
  5. EXPOSED PAD SHALL BE SOLDER PLATED
  6. SHADED AREA IS ONLY A REFERENCE FOR PIN 1 LOCATION ON THE TOP AND BOTTOM OF PACKAGE

---

## REVISION HISTORY

REV	DATE	DESCRIPTION	PAGE NUMBER
A	02/19	Added H-Grade version, updated graphics, app notes	All Pages
B	11/19	Added W-Grade (Automotive) version	All Pages

## TYPICAL APPLICATION

### Typical Application with Multiplexed Output

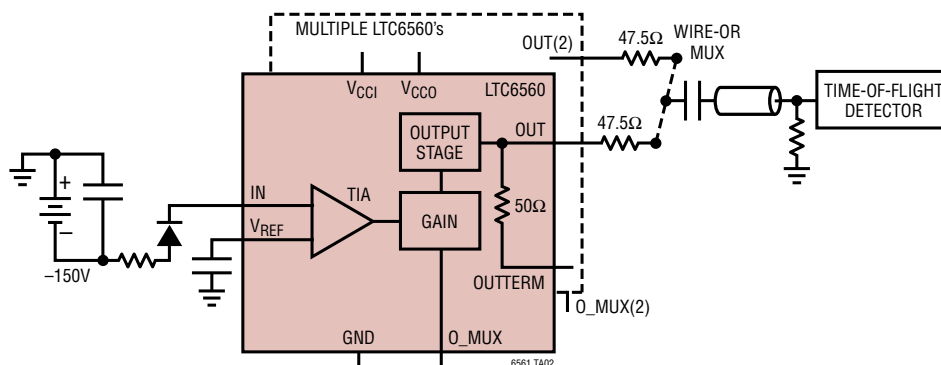

## RELATED PARTS

PART NUMBER	DESCRIPTION	COMMENTS
LTC6561	4-Channel 220MHz 74k TIA with Output MUX	4-Channel Version of the LTC6560
LTC6268	500MHz Ultra Low Bias Current FET Input Op Amp	
LTC6268-10	4GHz Ultra Low Bias Current FET Input Op Amp	De-Comped Version of the LTC6268
LTC6244	Dual 50MHz, Low Noise, Rail-to-Rail CMOS Op Amp	
LTC6240/LTC6241/ LTC6242	Single/Dual/Quad 18MHz, Low Noise, Rail-to-Rail Output CMOS Op Amps	
LTC6409	10GHz Bandwidth, 1.1nV/ $\sqrt{\text{Hz}}$ Differential Amplifier/ADC Driver	
ADA4930-1	Ultralow Noise Drivers for Low Voltage ADCs	Slew Rate: 2800 V/ $\mu\text{s}$
ADA4938-1	Ultralow Distortion Differential ADC Driver	Slew Rate: 4700 V/ $\mu\text{s}$
ADA4939-1	Ultralow Distortion Differential ADC Driver	Slew Rate: 6800 V/ $\mu\text{s}$
AD9694	Quad 14-Bit, 500 MSPS, 1.2 V/2.5 V ADC	JESD204B
AD9695-625	14-Bit, 1300 MSPS/625 MSPS, JESD204B, Dual ADC	JESD204B
HMCAD1511	High Speed Multi-Mode 8-Bit 1 GSPS A/D Converter	Serial LVDS
LT8331	DC/DC Boost Converter	with 140V Switch
LT3757	DC/DC Boost Controller	2.9V to 40V Input

# Mouser Electronics

Authorized Distributor

Click to View Pricing, Inventory, Delivery & Lifecycle Information:

[Analog Devices Inc.:](#)

[LTC6560IUD#PBF](#) [LTC6560IUD#TRPBF](#) [LTC6560HUD#TRPBF](#) [LTC6560HUD#PBF](#) [DC2803A](#)  
[LTC6560HUD#WPBF](#) [LTC6560HUD#WTRPBF](#) [DC2807A](#)