



Product Catalogue

Lighting, Boxes, Cabinets,
Conduits, Fittings & Accessories for
Hazardous and Hostile Areas



Welcome to Thomas & Betts

At Thomas & Betts, our focus is on improving your business performance by providing practical, reliable electrical products & services. To connect & protect for life. To solve everyday problems in the area's of Wire & Cable Management, Cable Protection, Power Connection & Control and Safety. Our extensive engineering, supply chain management and technical sales support teams are committed to understanding everything that impacts your ability to accomplish your business objectives by reducing your total cost of ownership.

Whether you are designing, installing, operating, maintaining or owning an office building, off-shore platform, hospital, or a high speed train, power generating plant, machine equipment or a manufacturing facility, Thomas & Betts engineered products fit and function in your application while providing superior performance, sustainability, and value throughout the project life cycle.

All our brands are built upon four product & service solution platforms. Platforms that address you or your customers' critical electrical & lighting needs covering the protection of data, energy, processes, assets and personal safety. Beyond hi-performance application characteristics, Thomas & Betts products, information and services facilitate and speed up your time critical assembly, installation or maintenance process.



Thomas & Betts in Europe:



VanLien



KAUFEL



Adaptaflex



furse



ETS



Ty-Rap

Contents

Oil & Gas - Upstream Applications	4-5	Lighting Accessories & Spare Parts	90-95
Oil & Gas - Midstream Applications	6-7	Lamps Guide	96-97
Oil & Gas - Downstream Applications	8-9	Wellglass	98-99
Food & Beverage Applications	10		
Chemical & Pharmaceutical Applications	11	Ex Boxes & Enclosures	100-101
World Standards & What They Mean	12-13	Boxes & Enclosures - Selection Guide	102-103
Zone Definitions - Onshore Gases & Vapours	14-15	XBL Range - XB100 Junction Boxes - GRP	104-105
Zone Definitions - Offshore Gases & Vapours	16	XBL Range - Junction Boxes - GRP	106-107
Zone Definitions - Dust	17	XBL Range - Instrumentation Boxes - GRP	108-109
DTS - Product Marking Guide	18-19	XBL-A Range - Control Boxes - GRP	110-111
Kopex Ex - Product Marking Guide	20-21	XB Range - Instrumentation Boxes - Aluminium	112-113
Index of Ingress Protection	22	XB-A Range - Control Boxes - Aluminium	114-115
Photometry	23	XBi Range - Instrumentation Boxes - Stainless Steel	116-117
		XBi-A Range - Control Boxes - Stainless Steel	118-119
		GUV Range - Junction Boxes - Aluminium	120-121
Ex Lighting Fittings	24-25	EFDC / SRC / XMC Range - Control Boxes - Aluminium	122-123
Lighting Fittings - Selection Guide	26-27	Custom Built Enclosures	124-125
Ex Lighting		EJB Range - Custom Built Panels - Aluminium	126-127
XFF Range - Ex d	28-29	GUB Range - Custom Built Panels - Aluminium	128-129
XFP Range - Ex de	30-31	EJB-V Range - Boxes with visible breaking - Aluminium	130-131
XEL Range - Ex d	32-33	Box Accessories & Spare Parts	132-133
XEP Range - Ex de	34-35		
XF Range - Ex de	36-37	Conduit Systems	134-135
XFB / XFL Range - Ex n	38-39	Conduit Fittings - Selection Guide	136-137
XDF Range - Ex nA	40-41	EXB / EXBB / XESX Range	138-139
EVS Range - Ex de	42-43	EXBQM / EXPQA Range	140-141
EVN Range - Ex n	44-45	NENV / NENZ Range	142-143
EVD Range - Ex t	46-47	NEBV 90° Curved Elbow / NEWV 90° Elbow /	144-145
ESB Range - Ex de	48-49	NEAV 45° Elbow Range / BESGR /	
Ex Emergency and Self-contained Lighting		BEYR Y Piece / BETR T Piece Range	
XFF-EM Range - Ex d	50-51	BEAVR / NEIR / HEAK / BENR-REM Range	146-147
XFP-EM Range - Ex de	52-53	EXLB / EXLT / EXLH / EXBBT / EXLHC Range	148-149
XEL-BAES Range - Self-contained Lighting - Ex d	54-55	EXSB / EXST / EXSH / EXSBBT / EXSHC Range	150-151
XEL-BAES Range - Remote Control Units	56-57	G1 Gland / 90° Elbow Gland	152-154
EVS-EM Range - Ex de	58-59	Universal / Universal Swivel Gland	155-157
EVS-EMA Range - Ex de	60-61	Group II Gland	158-159
EVN-EM Range - Ex n	62-63	XP Flex Range	160-161
EVD-EM Range - Ex t	64-65	Ex d Double Compression Cable Gland	162-163
ESB-EM Range - Ex de	66-67	Ex d Single Compression Cable Gland	164-165
Industrial Lighting - Non-Hazardous Locations	68-69	Ex e Cable Gland	166-167
FF Range	70-71	Nylon Cable Gland	168-169
EL Range	72-73	Enlargers, Reducers & Thread Convertors	170-173
SF / QF / HF Range	74-75	Ex d Stopping Plugs - Standard / Tamperproof	174-175
EVT Range	76-77	Ex e Stopping Plugs - Hex Head / Dome Head / Nylon	176-177
EST Range	78-79	Accessories	178-179
FB / FL Range	80-81		
HF Range	82-83	INDEX	180-189
Industrial Emergency Lighting - Safe Area		Thomas & Betts Worldwide Industrial Capabilities	190-191
FR-EM / FF-EM Range	84-85	Key of Symbols	192
EVT-EM Range	86-87		
EST-EM Range	88-89		



Oil & Gas - Upstream Applications

Industry Overview

The oil and gas market is split into three sectors Upstream, Midstream and Downstream. Upstream consists of Exploration and production both these areas offer very distinct and unique challenges to people and equipment working within them.

Firstly there are offshore applications such as the drilling rigs and production platforms; these are always open to extreme weather conditions so equipment used here needs to be able to withstand a salty environment. This is achieved through either manufacturing product from stainless steel as is the case for the Kopex-Ex conduit glands, and DTS enclosures, or by ensuring that the product is coated or painted to withstand marine environments as in the DTS XFF fluorescent lighting.

Equipment in offshore applications also needs to be hardwearing and easy to maintain as production downtime can be extremely costly for example FPSO (Floating Production Storage and Offloading) vessel can produce up to 200,000 barrels of crude oil per day at approx \$80 to \$90 per barrel. A breakdown would result in the vessel producing a loss of revenue of over \$700,000 per hour.

Approvals / Characteristics



Product Selection

- Salt water corrosion (offshore platforms)
- Oil and chemical resistance (Drilling rig MUD)
- Extreme ambient temperature
- Protection level
- Connectivity to other pieces of equipment
- Consequence of down time
- Approval level required (Ex e, Ex d, etc.)
- Approval specification required ATEX, IECEx, UL, GOST, etc.
- Where product will be positioned, e.g. Zone 1 or Zone 2



This has led to Kopex-Ex conduit systems being used in many offshore applications to protect critical data and power cables across these massive vessels, whether it is data cables from a gas detector or the cable protection on a power transmission unit, Kopex-Ex offers a whole range of products that are tested and approved to many of the world standards.

DTS lighting on the other hand offers easy maintenance with removable gear trays allowing the maintenance to be carried out quickly and safely. In fact on the XFF Exd luminaries the components such as ballasts and tubes are standard so the stocking and sourcing of spare parts is made easy. Again essential to an offshore vessel.

Onshore applications can also be split into exploration and production. However onshore is more economically viable than offshore with some wells only producing as few as a dozen barrels of oil a day. However, they can become extremely large with wells being networked together to produce up to a million barrels of oil a day.

This brings with it a whole new series of challenges to be overcome. Firstly the drilling rigs tend to be mobile with motors and pumps often mounted on skids for easy transportation. This can lead to issues of connectivity for which Kopex-Ex have a range of thread converters in a variety of materials and approvals ready to resolve the problem.

Secondly with so many rigs in network there is a massive monitoring operation to be done to ensure that the flow of all the rigs is ongoing and consistent. This is where the DTS range of instrumentation boxes can offer great flexibility as they can be custom made to meet exact specifications.

The need to maintain flow also leads to the need for motors and controls on the well heads themselves often referred to as "Christmas Trees." These are under high pressure and must be able to withstand up to 1400 bar this is a critical area and has to be monitored closely to ensure that pressure do not fluctuate this is done by the valves within the wellhead controlled by motors. DTS EJB enclosures can be custom built to control these valves and at the same time monitor the pressures and relay it back to the central control point.

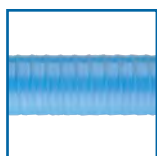

EXL Conduit 154



Stopping Plugs 176



EJB Range 132



XFF Range 28

Related Products



Oil & Gas - Midstream Applications

Industry Overview

Midstream relates to the transportation, storage and partial processing of crude oil and gas from the wellheads to the refining plants. This brings a different set of challenges to overcome.

This all relates to the fact that what is pumped out of the well is not pure and often contains a mixture of oil, gas, water and often sand which firstly need to be separated off from each other before being shipped or piped to a storage facility.

This can be done in a variety of ways depending on the type of oil or gas that the well is pumping and can often take up to 4 processes before the commodity is separated out ready for piping or shipping. These processes require energy and this energy is often created from the commodity itself by the utilization of the gas.

Once the separating has been completed, the commodity can then be moved to storage. In the case of an offshore rig this separating is often done on shore away from the rig then pumped to the storage depots. In the case of the FPSO vessels it is all done on board and the oil transferred to tankers at sea for delivery to storage depots.

Approvals / Characteristics



Product Selection

- Salt water corrosion (Tankers)
- Extreme ambient temperature
- Protection level
- Consequence of down time
- Approval level required (Ex e, Ex d, etc.)
- Approval specification required ATEX, IECEx, UL, GOST etc
- Where product will be positioned, e.g. Zone 1 or Zone 2



This is also the point when all metering needs to take place to calculate invoices and taxes today. This is done very accurately measuring not only the amount of oil produced but also the density, viscosity, pressure and temperature, and in the case of gas, the amount of water vapour.

Oil is often pumped direct to the oil refinery which is where the down stream operation starts but often needs to go through a series of pumps to get the required pressure.

With DTS and the Kopex-Ex range of products, Thomas & Betts can offer a range of products and services to meet the demands of midstream oil and gas markets. The DTS range of lighting products is manufactured to meet ATEX and IECEx standards. Designed to be robust to meet the vigors of the environment whether it is on oil tankers where the XFF product is ideal. To storage depots where the EVS range of fluorescents is often preferred. Added to this all the fluorescent lighting has been designed with the installer and maintenance people in mind with removable gear trays for easy and safe installation and maintenance.

DTS also offers a wide range of standard and custom made instrumentation boxes often used in the monitoring equipment to relay signals from the sensors back to the central control systems. As well as a range of standard configuration for control boxes including "Emergency Stop" and "On - Off" to control motors etc. All of these are available in GRP, aluminum and Stainless steel 316 therefore meeting any environmental requirement.

Kopex-Ex conduits are used in many applications including to protect the critical data cables feeding the information from sensors to the instrumentation boxes as well as being used on the compressors protecting the wiring where temperatures can reach over 100°C.

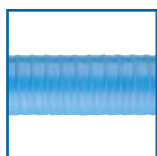

EXL Conduit 148



Stopping Plugs 176



EFDC Range 122



EVS Range 42

Related Products



Oil & Gas - Downstream Applications

Industry Overview

The term downstream relates to the processing and delivery of finished carbon related product to the end-user. This covers a whole range of applications from refining to petrol stations.

There are over 700 refineries globally all competing to supply finished carbon based products to local and international markets. The products refined are varied including:

- **Transportation fuels**
LPG, gasoline, jet fuel, diesel, gas oil and bunker fuel.
- **Petrochemical feedstocks**
LPG, naphtha and aromatics.
- **Energy sources**
LPG, kerosene, heating oil and fuel oil.
- **Specialities**
Lubricants, bitumen, coke, solvents and waxes.
- **Petrochemical feedstocks**
Synthetic fibres (nylon), plastics (polyethylene, PVC).

Approvals / Characteristics



Product Selection

- Continual Movement (CCTV)
- Extreme ambient temperature
- Protection level
- Consequence of down time
- Approval level required (Ex e, Ex d, etc.)
- Approval specification required ATEX, IECEx, UL, GOST, etc.
- Where product will be positioned, e.g. Zone 1 or Zone 2



The refining process is in four stages, firstly distillation which separates it into 5 product sectors LPG, Naphtha, Kerosine, Gas, Oil, and Atmospheric residue, this is done using high temperature. The higher the temperature the higher the quality of the product.

The second stage is the upgrading or reforming. This stage is used to change the product at a molecular level for example changing the low octane version of Naphtha to high octane which can be blended into gasoline.

Stages three and four are about treating the product to remove impurities such as sulphur and blending the refined product into distinct products for the market.

The final stage of the downstream process is delivery to the market which involves storage and transportation. For example in the case of aviation fuel this can be shipped direct to airports by road or rail where it is stored, before transferring to tanker trucks for the refuelling of aircraft.

All the stages in the downstream operation have different requirements to ensure safety of personnel and the quality of the end product. DTS and Kopex-Ex products are both used in this area whether it is the XF floodlight range or EVS fluorescent range. They are all designed for easy maintenance. There is also a range of instrumentation boxes either with standard configurations or custom made to end-user requirements, all of which are essential within a refinery where sensors play a key part on the process to ensure quality.

Kopex-Ex also plays a key part within the downstream market. It is not just used to protect the sensor cables but also for security on CCTV all the way through to the cable protection on rail tankers and tanker trucks.



EXL Conduit 148



Stopping Plugs 176



XF Range 36



EVS Range 42

Related Products



Food & Beverage Applications

Food Manufacture - Explosion Proof (Dust)



Food Industry

Thomas & Betts offer a range of products for the food processing market, including products for use in areas where stainless steel is preferred as well as areas classed as hazardous. Thomas & Betts can offer stainless steel control stations for use on automated food processing and packaging machines as well as lighting specifically designed for use in dust filled atmospheres such as flour mills or other places where the risk of explosion is considered to be extremely high.

Beverage Manufacture - Explosion Proof (Vapour)

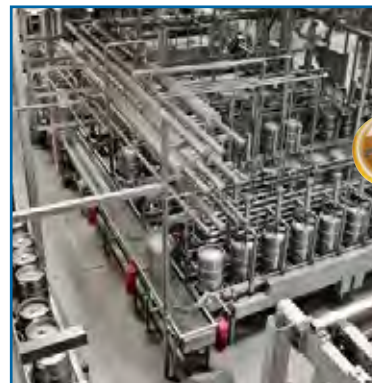

Beverage Industry

Thomas & Betts has a range of products designed for use in all beverage production sectors in the malting, brewing, wine, spirits or soft drink business. DTS can supply lighting products to suit the needs of hazardous areas where explosive gases may occur or in areas where cleanliness is required.



Chemical & Pharmaceutical Applications

Chemical Engineering - Explosion Proof

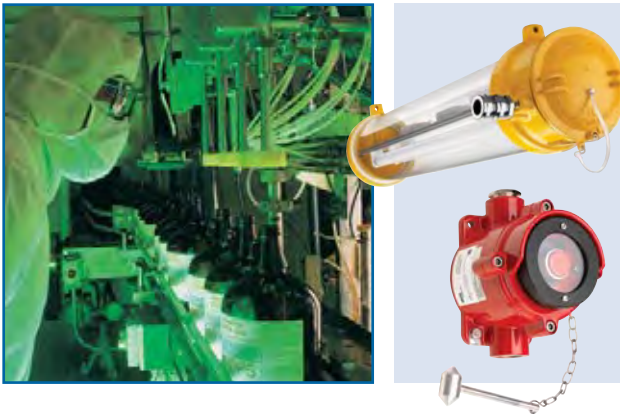

Chemical Industry

The chemical industry produces very diverse products, everything from fertilizers to explosives such as nitroglycerin. The processes used in this industry mean that there are lots of applications for the DTS lighting and box ranges. DTS can offer standard or custom built products, whether it is for a process control station or for instrumentation boxes linking sensors back to central control panels.

Pharmaceutical Production - Explosion Proof

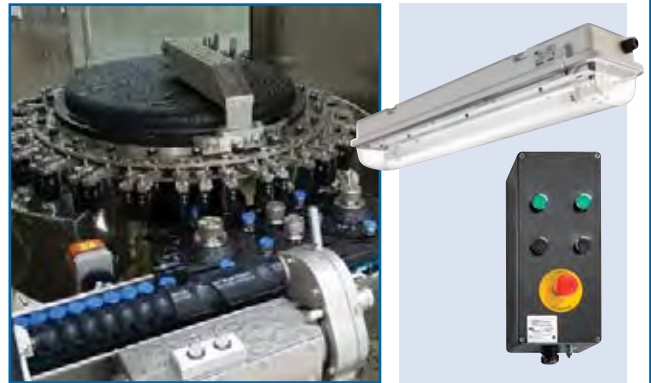

Pharmaceutical Industry

The Thomas & Betts range of products and solutions are ideal for use in the pharmaceutical Industry. Whether it is upstream in the primary production stage or downstream in the packing stage. Many of the processes and applications used in these areas require approvals to hazardous area standards making stainless steel junction and control boxes ideal.

World Standards and what they mean

Standards and what they mean

In this Section we will outline the different Standards used throughout the world and what it means for products specified for use in Hazardous Areas. Below is a map of the world which illustrates the Standards that are generally used in these regions.

Product Approvals



UL

CLASS & DIV



CSA

CLASS & ZONES



IECEX



ATEX



GOST



INMETRO

GROUPS & ZONES



The ATEX Europe Directives 94/9/EC

ATEX requires employers to eliminate or control risks from dangerous substances and to classify areas where explosive atmospheres may occur into zones, as laid down in regulations. ATEX Directives are designed to protect employees, the public and the environment from accidents owing to explosive atmospheres and since July 1st 2006 all existing sites, as well as new sites, must be fully ATEX compliant.

Directive ATEX100a applies to equipment suppliers and manufacturers and ATEX137 applies to end users. These directives compliment each other, but have different purposes. ATEX100A covers both electrical and non-electrical products intended for use in hazardous areas, including mechanical equipment. The Directive came into existence in 2003 and products sold within the European Union designed for use in hazardous areas must have ATEX certification and bear the

ATEX marking on the product or on a certificate plate. The obligation is placed upon the manufacturer or supplier of the product and the intention is to facilitate free movement of goods within the EU.

Declaration of Conformance

This has to be issued by the supplier for every order which is to be installed in a hazardous area. This document has to show that the equipment supplied complies with the latest harmonized standard.



IECEx (International Scheme)

The IECEx scheme is an international certificate of conformance for products used in a hazardous area.

This scheme provides:

- a) A single certification of conformity for manufacturers to comply that includes:
 - i) Testing and assessment of products to a standard including a full test report.
 - ii) Ongoing surveillance of manufacturers premises.
- b) A fast-track process for countries where regulations still require the issuing of national Ex certificates or approvals.

This scheme is in the process of being adopted by all the known standards across the world but are all working to various time scales.



UL (America) & CSA (Canada)

The American and Canadian standards are the only ones to have different classifications and locations. ATEX & IECEx work to Groups and Zones whereas the NEC & CEC works to Classes and Divisions, there is no direct comparison between the two. This means that it is imperative that the two standards are not inter-changed within an area.



GOST (Russia)

GOST follows similar rules to that of IECEx as far as the breakdown of the zones and other criteria are concerned. However, the requirements for this country mean that separate GOST markings are required on the product.

GOST is divided into GOST (R) which is the standard for Russian Federation and GOST (K) that cover Kazakhstan.

Electrical materials for use in potentially explosive atmospheres must conform to two major certification standards: IEC/CENELEC and NEC

The IEC (International Electrotechnical Commission) standards are accepted in practically all countries. They are identical to the European CENELEC standards.

The NEC (National Electrical Code) is mandatory in the United States. The 1996 version, art. 505, takes up the IEC designations for gas, temperature classes for materials and zone definition.

Gases and vapours classification

Gases are divided into four groups in the NEC (National Electrical Code) and three groups for IEC/CENELEC. The groups display the same hierarchy of classification of gases and vapour. (See table on page 20).

Temperature classification

The IEC and the NEC have also defined a temperature classification for material used in zones at risk of explosion. (See table on page 21).



Zone Definitions Onshore Gases & Vapours (as per ATEX 60079-10)

Zones for Onshore Gases & Vapours

FOR GASES & VAPOURS



ZONE 0

Permanent / Frequent

Place in which an explosive atmosphere consisting of a mixture with air of flammable substances in the form of gas, vapour or mist is present continuously or for long periods, or frequently.



ZONE 1

Occasional

Site where an atmosphere consisting of a mixture of air and inflammable substances in the form of gas, vapour or mist is likely to arise occasionally during normal operation.

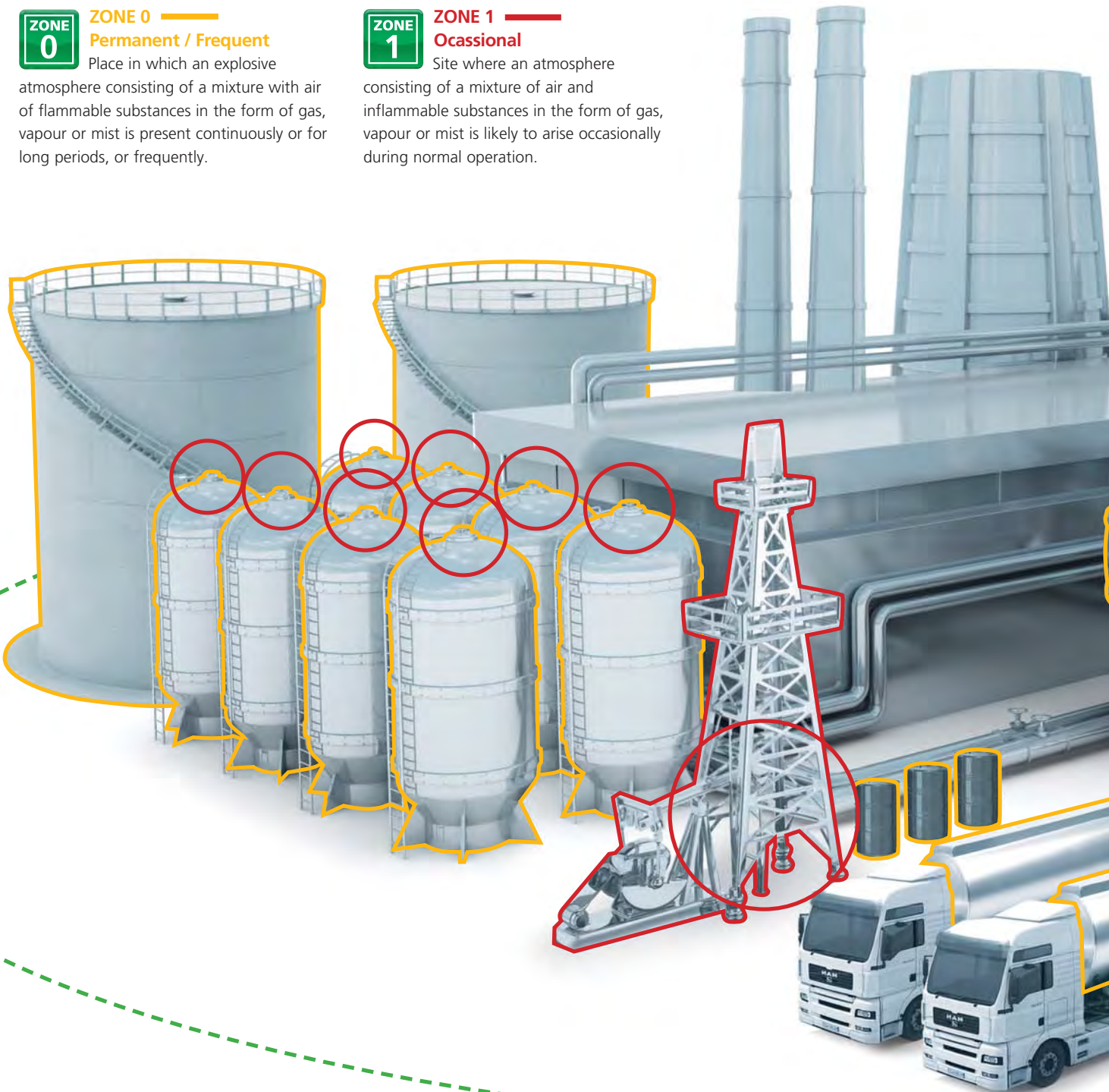

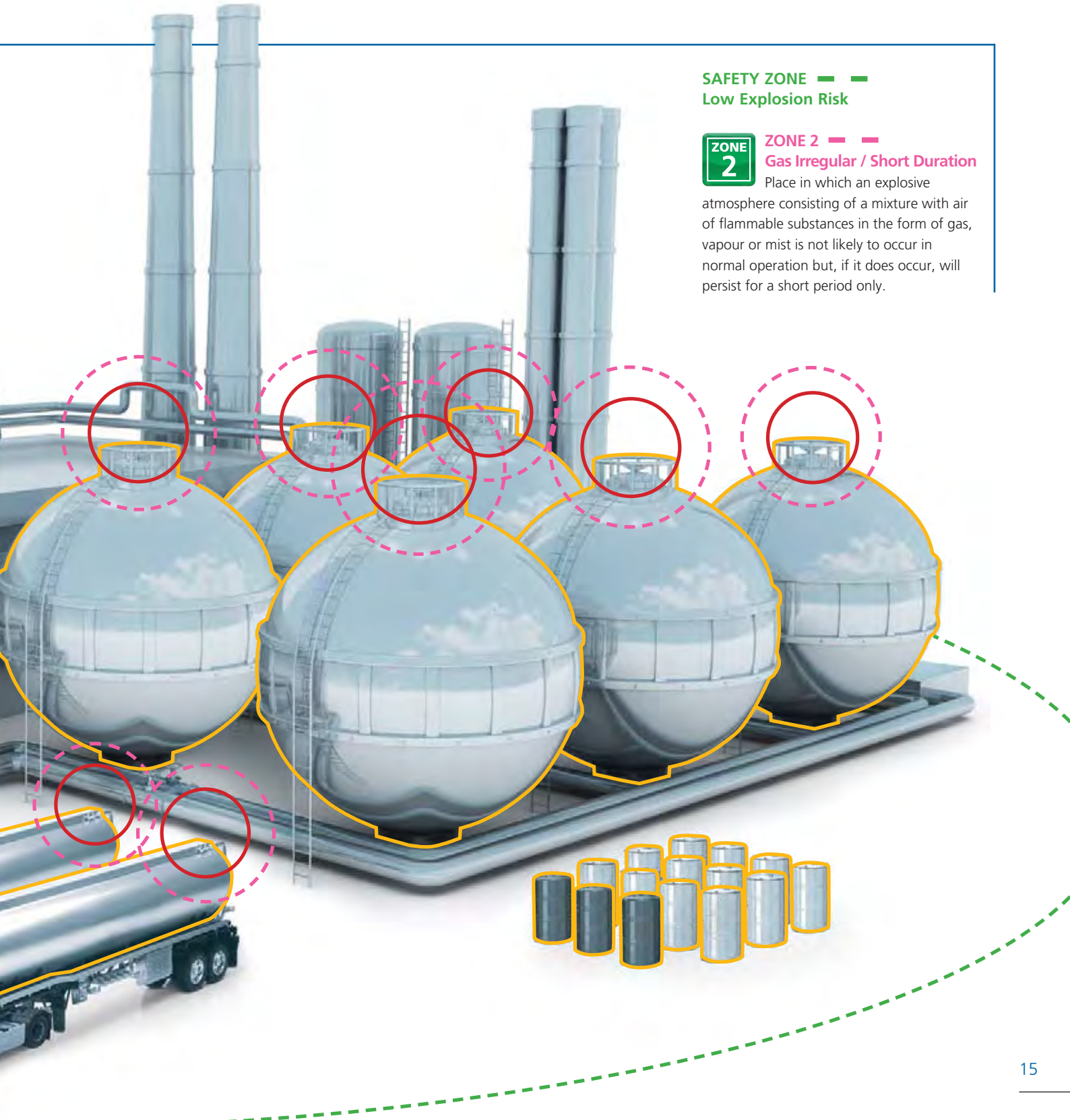

SAFETY ZONE — —
Low Explosion Risk

ZONE 2

ZONE 2 — —
Gas Irregular / Short Duration

Place in which an explosive atmosphere consisting of a mixture with air of flammable substances in the form of gas, vapour or mist is not likely to occur in normal operation but, if it does occur, will persist for a short period only.

Zone Definitions Offshore Gases & Vapours (as per ATEX 60079-10)

Zones for Offshore Gases & Vapours

FOR GASES & VAPOURS



ZONE 0

Permanent / Frequent

Place in which an explosive atmosphere consisting of a mixture with air of flammable substances in the form of gas, vapour or mist is present continuously or for long periods, or frequently.

SAFETY ZONE

Low Explosion Risk



ZONE 1

Occasional

Site where an atmosphere consisting of a mixture of air and inflammable substances in the form of gas, vapour or mist is likely to arise occasionally during normal operation.



ZONE 2

Gas Irregular / Short Duration

Place in which an explosive atmosphere consisting of a mixture with air of flammable substances in the form of gas, vapour or mist is not likely to occur in normal operation but, if it does occur, will persist for a short period only.

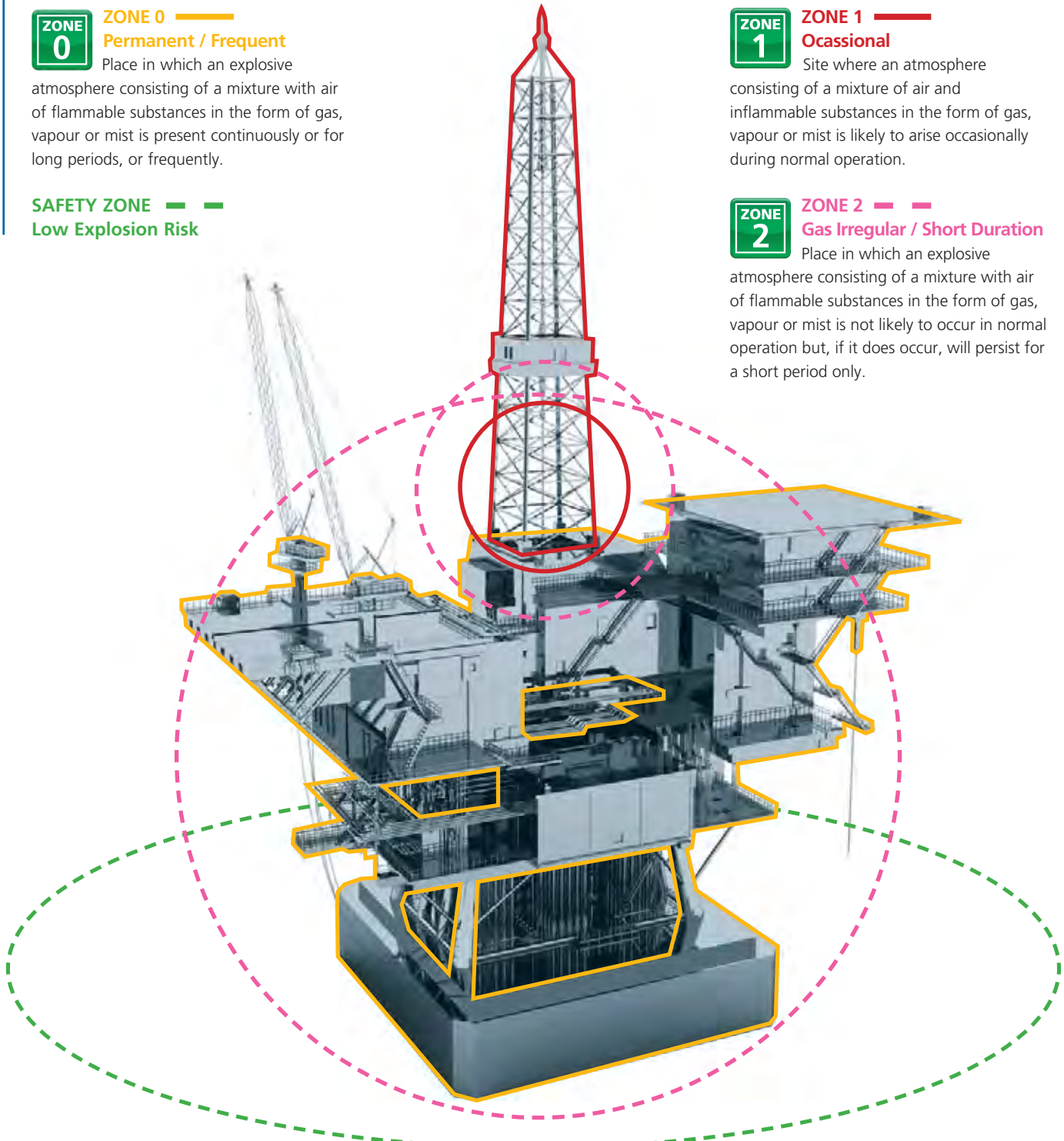

Zone Definitions Dust (as per ATEX 60079)

Zones for Dust

FOR DUST

ZONE 20

ZONE 20 ———
Permanent / Frequent

Area in which an explosive atmosphere in the form of a cloud of combustible dust in air is present continuously, or for long periods, or frequently.

SAFETY ZONE ———
No Explosion Risk

ZONE 21

ZONE 21 ———
Occasional

Area in which an explosive atmosphere, in the form of a cloud of combustible dust in air is likely to occur, occasionally, in normal operation, occasionally.

ZONE 22

ZONE 22 ———
Dust Irregular / Short Duration

Area in which an explosive atmosphere, in the form of a cloud of combustible dust in air is not likely to occur in normal operation but, if it does occur, will persist for a short period only.

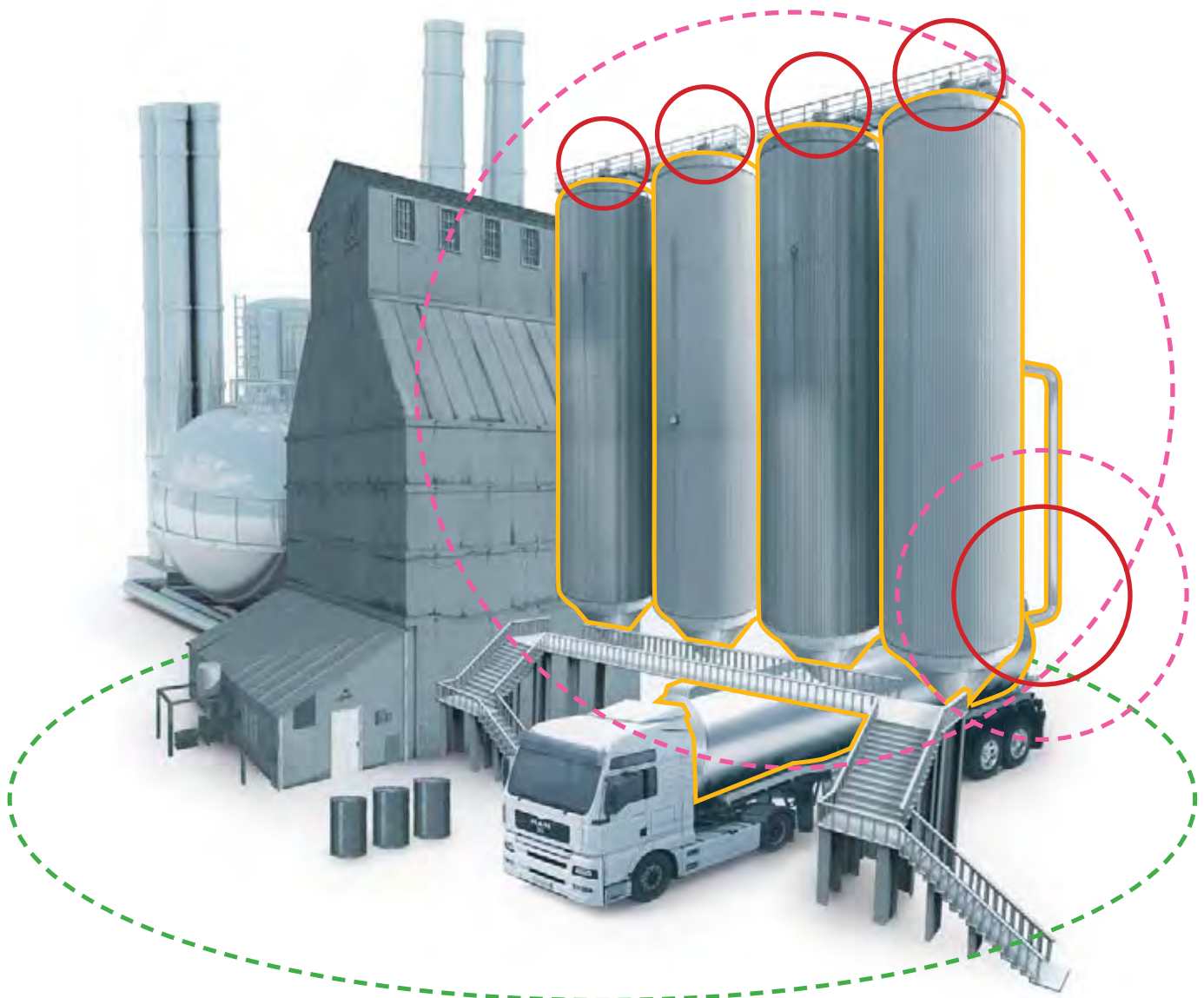

DTS - Classification of equipment for use in potentially explosive atmospheres

Classification of hazardous areas		European/IEC or NEC classifications		
Flammable substances	Temporary behaviour of flammable substances in hazardous places	Typical zones	Required marking for installation	
			equipment group	equipment protection level
Gases Vapours	is present continuously or for long periods or frequently	zone 0	II	Ga
	is likely to occur in normal operation occasionally	zone 1	II	Gb
	is not likely to occur in normal operation but, if it does occur, will persist for a short period only	zone 2	II	Gc
Dusts	is present continuously or for long periods or frequently	zone 20	III	Da
	is likely to occur in normal operation occasionally	zone 21	III	Db
	it is not likely to occur in normal operation but, if it does occur, will persist for a short period only	zone 22	III	Dc
Methane Dusts	-	mines	I	Ma
	-	mines	I	Mb

Subdivision of gases and vapours						
Apparatus may be used in group			Gases or vapours			
IIA	IIIB	IIIC	ammonia	ethyl alcohol	galsoline	acetaldehyde
			methane	cyclohexane	n-hexane	
			ethane	n-butane		
			propane			
			town gas,	ethylene	ethylene	ethyl-ether
			acrylnitril	ethylene oxide	glycol	
			hydrogen	ethine (acetylene)	sulphide of carbon	

Dust	
IIIA	Combustible Flyings
IIIB	Non-Conductive Dust
IIIC	Conductive Dust

Product stamp detail

DTS
 XB10-SI
 U=415V/50Hz

19-21, avenue Henri Baudalet
 77831 Ozoir-la-Ferriere (France)

12/0116422
 (Serial No.)

0081 **Ex II 2 G Exe IIC T6/II 2 D Extb IIIC T85C IP66**
 (Gas) (Dust)

LCIE 11 ATEX 3050 X
 (Certification Number)



Restriction for using apparatus	
Requirements	Marking
Equipment without restriction	-
Equipment with special condition may be noted	X
Ex component, which is not intended to be used alone and requires additional certification before being used in hazardous area	U

Protection technique					
Application	Type of protection		Marking	EN/IEC standard	
All applications	General requirements		-	60079-0	
Control stations, motors, fuses, switchgear, power electronics	Flameproof enclosure		Ex d	60079-1	
Installation materials, motors, luminaries	Increased safety		Ex e	60079-7	
Measurement and control, automation technology, sensors, actuators	Intrinsic safety		Ex i	60079-11	
Switch- and control cupboards, analyse-apparatus, computers	Pressurisation		Ex p	60079-2	
Coils of motors or relays, solenoid valves	Encapsulation		Ex m	60079-18	
Transformers, relays, control stations, magnetic contactors	Oil immersion		Ex o	60079-6	
Capacitors, transformers	Powder filling		Ex q	60079-5	
See at the top - only for zone 2	'Non sparking'		Ex n	60079-15	
For use in zone 0, 1, 2 / for use in zone 1, 2	Dust atmospheres		Ex t	60079-31	

- IIA T1 Acetone 735°
- IIA T1 Ammonia 630°
- IIB T1 Carbon Monoxide 605°
- IIA T1 Bensene 560°
- IIC T1 Hydrogen 560°
- IIA T1 Methane 537°
- IIA T1 Toluene 535°
- IIA T1 Styrene 490°
- IIA T1 Propane 470°
- IIA T1 1-Butene 455°
- IIB T1 Butadiene 430°

- IIB T2 Ethylene 425°
- IIA T2 Butane 372°
- IIA T2 Ethanol 363°
- IIA T2 Butylalcohol 359°
- IIB T2 Dimetylerther 350°
- IIC T2 Acetylene 305°

- IIA T3 Nafta 290°
- IIB T3 Hydrogen Sulphide 270°
- IIA T3 Cyclohexane 259°
- IIA T3 Hexane 233°
- IIA T3 Heptane 215°
- IIA T3 Kerosene 210°
- IIA T3 Dekane 201°

- IIB T4 Diethyl Ether 160°
- IIC T6 Carbon Disulphide 95°

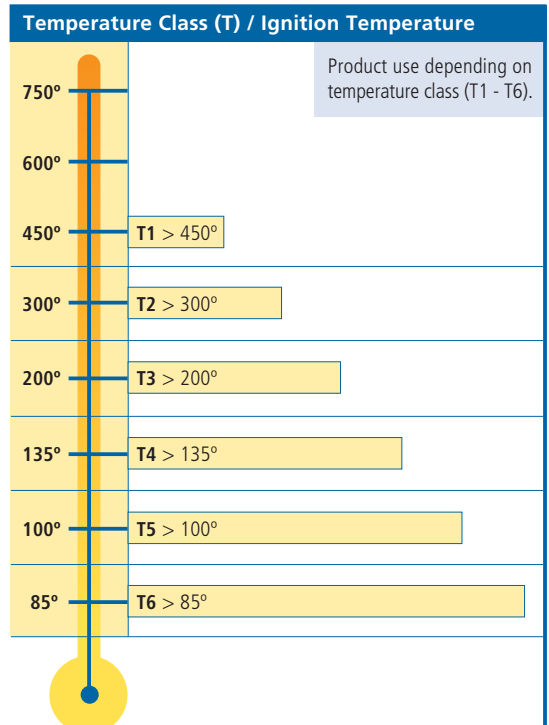

Kopex-Ex - Classification of equipment for use in potentially explosive atmospheres

Classification of hazardous areas		European/IEC or NEC classifications		
Flammable substances	Temporary behaviour of flammable substances in hazardous places	Typical zones	Required marking for installation	
			equipment group	equipment protection level
Gases Vapours	is present continuously or for long periods or frequently	zone 0	II	Ga
	is likely to occur in normal operation occasionally	zone 1	II	Gb
	is not likely to occur in normal operation but, if it does occur, will persist for a short period only	zone 2	II	Gc
Dusts	is present continuously or for long periods or frequently	zone 20	III	Da
	is likely to occur in normal operation occasionally	zone 21	III	Db
	it is not likely to occur in normal operation but, if it does occur, will persist for a short period only	zone 22	III	Dc
Methane Dusts	-	mines	I	Ma
	-	mines	I	Mb

Subdivision of gases and vapours			
Apparatus may be used in group	Gases or vapours		
IIA	ammonia	ethyl alcohol	galsoline
	methane	cyclohexane	n-hexane
IIB	ethane	n-butane	
	propane		
IIC	town gas, acrylnitril	ethylene oxide	ethyl-ether
	hydrogen	ethine (acetylene)	sulphide of carbon

Dust	
IIIA	Combustible Flyings
IIIB	Non-Conductive Dust
IIIC	Conductive Dust

Product stamp detail

CMPL **I M2/II 2GD Exde I Mb Exde IIC Gb Extb IIIC Db**

(Product stamp detail)

CLI.Div1.ABCD .CLII.Div1.EFG.

(Class & Divisions)

CLI (Class I), Div1

Where ignitable concentrations of flammable gases, vapors or liquids are present within the atmosphere under normal operation conditions.

CLI (Class I), Div2

Where ignitable concentrations of flammable gases, vapors or liquids are present within the atmosphere under abnormal operation conditions.

Class I Areas

Group A: Acetylene / Group B: Hydrogen /

Group C: Propane & Ethylene / Group D: Benzene, Butane & Propane.

CLII (Class II), Div1

Where ignitable concentrations of combustible dusts are present within the atmosphere under normal operation conditions.

CLII (Class II), Div2

Where ignitable concentrations of combustible dusts are present within the atmosphere under abnormal operation conditions.

Class II Areas

Group E: Metal Dust / Group F: Carbon & Charcoal / Group G: Flour, Starch, Wood & Plastic.



Restriction for using apparatus		Protection technique				
Requirements	Marking	Application	Type of protection		Marking	EN/IEC standard
Equipment without restriction	-	All applications	General requirements		-	60079-0
Equipment with special condition may be noted	X	Control stations, motors, fuses, switchgear, power electronics	Flameproof enclosure		Ex d	60079-1
Ex component, which is not intended to be used alone and requires additional certification before being used in hazardous area	U	Installation materials, motors, luminaries	Increased safety		Ex e	60079-7
		Measurement and control, automation technology, sensors, actuators	Intrinsic safety		Ex i	60079-11
		Switch- and control cupboards, analyse-apparatus, computers	Pressurisation		Ex p	60079-2
		Coils of motors or relays, solenoid valves	Encapsulation		Ex m	60079-18
		Transformers, relays, control stations, magnetic contactors	Oil immersion		Ex o	60079-6
		Capacitors, transformers	Powder filling		Ex q	60079-5
		See at the top - only for zone 2	'Non sparking'		Ex n	60079-15
		For use in zone 0, 1, 2 / for use in zone 1, 2	Dust atmospheres		Ex t	60079-31

IECEx SIRA09.0103 X

(Certification Number)

- IIA T1 Acetone 735°
- IIA T1 Ammonia 630°
- IIB T1 Carbon Monoxide 605°
- IIA T1 Bensene 560°
- IIC T1 Hydrogen 560°
- IIA T1 Methane 537°
- IIA T1 Toluene 535°
- IIA T1 Styrene 490°
- IIA T1 Propane 470°
- IIA T1 1-Butene 455°
- IIB T1 Butadiene 430°

- IIB T2 Ethylene 425°
- IIA T2 Butane 372°
- IIA T2 Ethanol 363°
- IIA T2 Butylalcohol 359°
- IIB T2 Dimetylerther 350°
- IIC T2 Acetylene 305°

- IIA T3 Nafta 290°
- IIB T3 Hydrogen Sulphide 270°
- IIA T3 Cyclohexane 259°
- IIA T3 Hexane 233°
- IIA T3 Heptane 215°
- IIA T3 Kerosene 210°
- IIA T3 Dekane 201°

- IIB T4 Diethyl Ether 160°
- IIC T6 Carbon Disulphide 95°

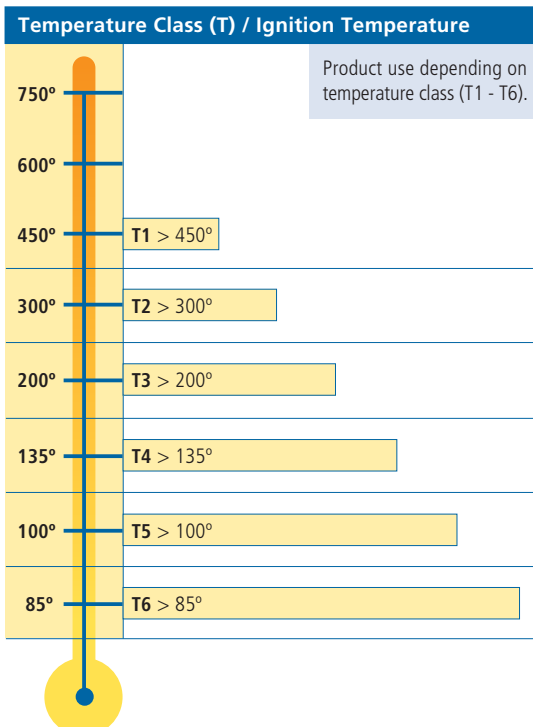

New Marking - EPL's (Explosion Protection Levels)

The introduction of the EPL's and changes in the EN 60079 series standard has introduced new marking requirements.

Index of Ingress Protection

IPxx suitability ratings are a system for classifying the degree of protection provided by enclosures of electrical equipment. The higher the number, the greater the degree of protection, in accordance with standards IEC 60529 and EN 60529.

Protection standards

- Protection against solid bodies
- Protection against liquids
- Protection against impact a per EN 50102 standard



Protection against Solid Bodies		
	0	No protection
	1	Protected against solid bodies of 50mm and greater, (e.g. accidental contact with the hand)
	2	Protected against solid bodies of 12.5mm and greater, (e.g. accidental touch by fingers)
	3	Protected against solid bodies of 2.5mm and greater, (e.g. tools and wires)
	4	Protected against solid bodies of 1mm or greater, (e.g. thin tools and fine wires)
	5	Protected against dust - limited ingress (no harmful deposits)
	6	Totally protected against dust (Dust-tight)

Protection against Liquids		
	0	No protection
	1	Protected against vertically falling drops of water (condensation)
	2	Protected against drops of water falling up to 15° from the vertical
	3	Protected against drops of water falling up to 60° from the vertical
	4	Protected against splashing water from all directions
	5	Protection against jets of water from all directions
	6	Protection against powerful jets of water from all directions
	7	Protected against the effects of temporary immersion in water
	8	Protected against the continuous effects of immersion in water having regard to specific conditions
	9	IP69k Automotive standard DIN40050 signifies resistance to high pressure jets (up to 80bar) from any angle

Hazlux®

Introducing the **NEW** Industrial and Hazardous Location Lighting Catalogue from Hazlux®

Thomas & Betts® is committed to delivering high quality industrial lighting fixtures designed, tested and certified for use in hazardous locations and adverse environment conditions.

You can rely on **Hazlux®** to safely provide light where you need it - even under the harshest indoor and outdoor conditions. If safety, labour reduction, quality and reliability are your priorities, consider **Hazlux®** lighting products to reduce maintenance and prevent downtimes. Specifically designed and approved to UL and CSA for the American market.



Call now to order!

our **NEW** Industrial and Hazardous Location Lighting product catalogue on tel +44 (0) 1675 468 213 or visit our website at www.tnb-hazardous.com



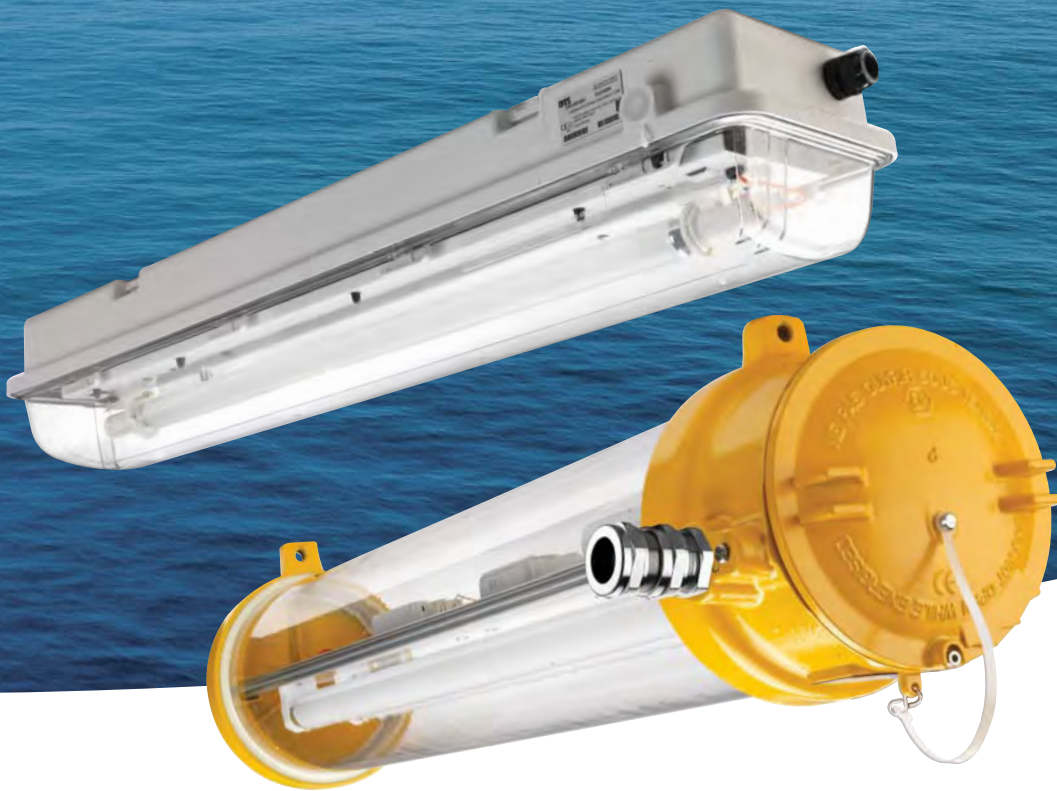

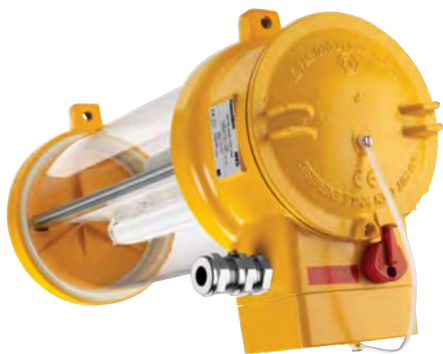



















Ex Lighting Fittings





Ex Lighting Fittings - Selection Guide

Ex Lighting Range

										
	XFF Page 28	XFP Page 30	XEL Page 32	XEP Page 34	XF Page 36	XDF Page 40	EVS Page 42	EVN Page 44	EVD Page 46	ESB Page 48
	●	●	●	●	●	●	●	●	●	●
					●		●		●	
Protection Type		●	●							
			●		●	●	●			●
		●	●	●	●		●	●		
						●		●		
						●				
									●	
Gas Groups		●	●		●					
		●	●	●	●	●	●	●		●
		●	●	●	●	●	●	●	●	
Zones		●	●	●	●	●	●	●		●
		●	●	●	●	●	●	●		●
		●	●	●	●		●		●	
		●	●	●	●		●	●	●	

Ex Emergency & Escape Lighting Range



XFF-EM
Page 50



XFP-EM
Page 52



XEL-BAES
Page 54



EVS-EM
Page 58



EVS-EMA
Page 60



EVN-EM
Page 62



EVD-EM
Page 64



ESB-EM
Page 66

	XFF-EM	XFP-EM	XEL-BAES	EVS-EM	EVS-EMA	EVN-EM	EVD-EM	ESB-EM
	●	●	●	●	●	●	●	
				●	●		●	
	●		●					
		●	●	●	●			●
	●	●	●	●	●	●		
						●		
							●	
	●	●						
	●	●	●	●	●	●		●
	●	●	●	●	●	●	●	
	●	●	●	●	●			●
	●	●	●	●	●	●	●	
	●	●	●	●	●		●	
	●	●	●	●	●	●	●	



XFF Range Tubular fluorescent fitting



Approvals / Characteristics

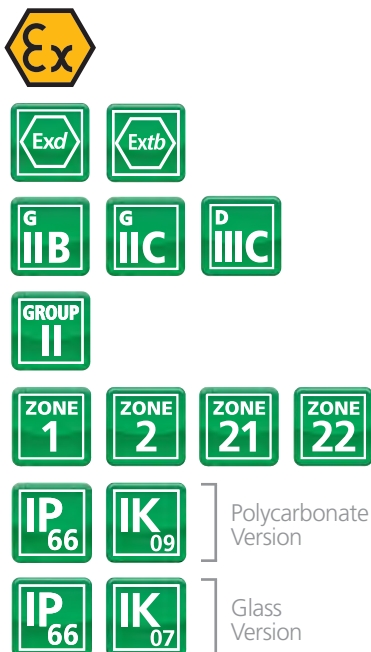

Features

- Manufactured from marine grade aluminium
- Supplied with offshore grade paint
- All components mounted on sliding gear tray for easy installation and maintenance
- Standard components used inside body allowing reduced maintenance costs
- Available in polycarbonate (light, high impact resistant) or in glass (specific chemical environment & paint shop)
- Including accessories (cable gland & fixing brackets)

Certification & Standards

Approved to: EN60079-0, 60079-1, 60079-31
 EC TYPE Examination Certificate:
 INERIS 11 ATEX 0051X
 Ex II 2 G
 Ex d IIC T6 Gb for ≤ -20°C to ≤ +55°C (All Polycarbonate tubes)
 Ex d IIC T6 Gb for ≤ -20°C to ≤ +55°C (Glass tubes)
 Ex d IIB T6 Gb for ≤ -20°C to ≤ +55°C (Glass versions - XFR140, XFR165, XFF240 and XFF265)
 Ex II 2 D
 Ex tb IIIC T80°C Db IP66
 Glow wire test: 960°C EN60598-2-22
 Safe operating temperature range: -20°C to +55°C



The fixture is supplied with non-barrier cable glands. For installations in either Zone 1 or in the presence of Group IIC gases, barrier glands are required. Please refer to EN-60079-14.

Dimensions

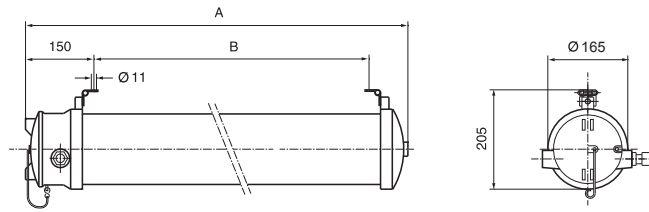

Technical Specifications

Type	Wiring Configuration	Rating (W)	Nominal Current (A)	Diffuser	Dimensions (mm)		Weight (kg)
					A	B	
XFR120-OG000	5 Wire	1 x 18	0.15	Polycarbonate	780	565	5.5
XFR136-OG000	5 Wire	1 x PL36	0.2	Polycarbonate	780	565	6
XFR140-OG000	5 Wire	1 x 36	0.2	Polycarbonate	1385	1170	9
XFR155-OG000**	5 Wire	1 x PL55	0.25	Polycarbonate	780	565	6
XFR165-OG000	5 Wire	1 x 58	0.35	Polycarbonate	1690	1475	11
XFF220-OG000	5 Wire	2 x 18	0.3	Polycarbonate	780	565	6.5
XFF236-OG000	5 Wire	2 x PL36	0.4	Polycarbonate	780	565	6.5
XFF240-OG000	5 Wire	2 x 36	0.4	Polycarbonate	1385	1170	10
XFF255-OG000**	5 Wire	2 x PL55	0.5	Polycarbonate	780	565	6.5
XFF265-OG000	5 Wire	2 x 58	0.5	Polycarbonate	1690	1475	12
XFR120V-OG000	5 Wire	1 x 18	0.15	Glass	780	565	7
XFR136V-OG000	5 Wire	1 x PL36	0.2	Glass	780	565	8
XFR140V-OG000	5 Wire	1 x 36	0.2	Glass	1385	1170	17
XFR155V-OG000**	5 Wire	1 x PL55	0.25	Glass	780	565	8
XFR165V-OG000	5 Wire	1 x 58	0.35	Glass	1690	1475	17
XFF220V-OG000	5 Wire	2 x 18	0.3	Glass	780	565	8.5
XFF236V-OG000	5 Wire	2 x PL36	0.4	Glass	780	565	8.5
XFF240V-OG000	5 Wire	2 x 36	0.4	Glass	1385	1170	18
XFF255V-OG000**	5 Wire	2 x PL55	0.5	Glass	780	565	8.5
XFF265V-OG000	5 Wire	2 x 58	0.5	Glass	1690	1475	20

**T5 for gas or T95°C for dust when supply is 240V AC

Enclosure

End caps according to standard:
EN1706:EN AC-AISI12(Fe) DF or
EN AC-AISI10Mg(a) DF marine grade aluminium
UV protected extruded polycarbonate tube,
thickness 2.5mm
Borosilicate glass, thickness 7mm

Fixing

Standard: D023 - 2 Zinc Plated Steel articulated
(brackets for ceiling mounting included)

Rated voltages

Electronic ballast:
AC/DC 110-260V, 50-60Hz

Power factor

Up to 0.98

Cable entries

Standard: Two entries 3/4" NPT included
One 3/4" Nickel Plated Brass plug (EXN075/SP)
One cable gland (EXN05AMC3) - 3/4" NPT Nickel
Plated Brass for non-armoured cable, diameter 12-16mm

Terminal block (plug in terminal block)

Up to 10mm² (rigid wire), 6mm² (flexible wire)
Terminals supplied L1, L2, L3, N, PE (looping possible
with 1 additional cable gland)

Lamps (order separately)

T8 bi-pin G13 tube, Ø 26 - white industry 4000°K
G11 compact fluorescent PL lamp

Shock proof kit

See dimension column A
D036 - 1690mm
D035 - 1385mm
D034 - 780mm

Other options

Stainless steel shock proof kit 304L

Colour (standard)

● XF****-OG000 - Yellow offshore, RAL 1003

Colour options

- XF****-BG000 - Grey, RAL 7035
- XF****-CG000 - Black, RAL 9004
- XF****-DG000 - Hammered Blue, RAL 5015
- XF****-FG000 - Red, RAL 3001
- XF****-GG000 - Blue, RAL 5010
- XF****-JG000 - Green, RAL 6032
- XF****-MG000 - White, RAL 9010

Spares & Fixings Accessories see pages 90-95



EXL Conduit 148



Stopping Plugs 174



GU Range 120



Ex d Cable Gland 162

Related Products



XFP Range

Tubular fluorescent fitting with automatic switch off



Approvals / Characteristics

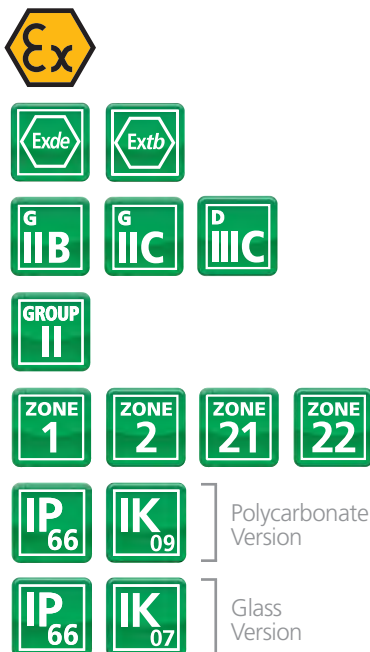

Features

- Manufactured from marine grade aluminium
- Supplied with offshore grade paint
- All components mounted on sliding gear tray for easy installation and maintenance
- Standard components used inside body allowing reduced maintenance costs
- Available in polycarbonate (light, high impact resistant) or in glass (specific chemical environment & paint shop)
- Including accessories (cable gland & fixing brackets)

Certification & Standards

Approved to: EN60079-0, 60079-1, 60079-7
 EC TYPE Examination Certificate:
 INERIS 11 ATEX 0052X
 Ex II 2 G
 Ex de IIC T6 Gb for $\leq -20^{\circ}\text{C}$ to $\leq +55^{\circ}\text{C}$ (All Polycarbonate tubes)
 Ex de IIC T6 Gb for $\leq -20^{\circ}\text{C}$ to $\leq +55^{\circ}\text{C}$ (Glass tubes)
 Ex de IIB T6 Gb for $\leq -20^{\circ}\text{C}$ to $\leq +55^{\circ}\text{C}$ (Glass versions - XFP140V, XFP165V, XFP240V and XFP265V)
 Ex II 2 D
 Ex tb IIIC T80°C Db IP66
 Glow wire test: 960°C EN60598-2-22
 Safe operating temperature range: -20°C to $+55^{\circ}\text{C}$

Dimensions

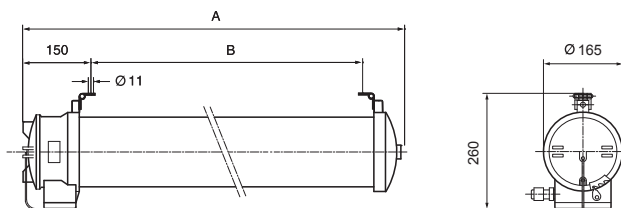

Technical Specifications

Type	Wiring Configuration	Rating (W)	Nominal Current (A)	Diffuser	Dimensions (mm)		Weight (kg)
					A	B	
XFP120-0G000	3 Wire	1 x 18	0.15	Polycarbonate	780	565	5.5
XFP136-0G000	3 Wire	1 x PL36	0.2	Polycarbonate	780	565	6
XFP140-0G000	3 Wire	1 x 36	0.2	Polycarbonate	1385	1170	9
XFP155-0G000**	3 Wire	1 x PL55	0.25	Polycarbonate	780	565	6
XFP165-0G000	3 Wire	1 x 58	0.35	Polycarbonate	1690	1475	11
XFP220-0G000	3 Wire	2 x 18	0.3	Polycarbonate	780	565	6.5
XFP236-0G000	3 Wire	2 x PL36	0.4	Polycarbonate	780	565	6.5
XFP240-0G000	3 Wire	2 x 36	0.4	Polycarbonate	1385	1170	10
XFP255-0G000**	3 Wire	2 x PL55	0.5	Polycarbonate	780	565	12
XFP265-0G000	3 Wire	2 x 58	0.5	Polycarbonate	1690	1475	12
XFP120V-0G000	3 Wire	1 x 18	0.15	Glass	780	565	7
XFP136V-0G000	3 Wire	1 x PL36	0.2	Glass	780	565	8
XFP140V-0G000	3 Wire	1 x 36	0.2	Glass	1385	1170	17
XFP155V-0G000**	3 Wire	1 x PL55	0.25	Glass	780	565	8
XFP165V-0G000	3 Wire	1 x 58	0.35	Glass	1690	1475	17
XFP220V-0G000	3 Wire	2 x 18	0.3	Glass	780	565	8.5
XFP236V-0G000	3 Wire	2 x PL36	0.4	Glass	780	565	8.5
XFP240V-0G000	3 Wire	2 x 36	0.4	Glass	1385	1170	18
XFP255V-0G000**	3 Wire	2 x PL55	0.5	Glass	780	565	18
XFP265V-0G000	3 Wire	2 x 58	0.5	Glass	1690	1475	20

**T5 for gas or T95°C for dust when supply is 240V AC

Enclosure

End caps according to standard:
EN1706:EN AC-AISI12(Fe) DF or EN AC-AISI10Mg(a) DF marine grade aluminium
UV protected extruded polycarbonate tube, thickness 2.5mm

Borosilicate glass, thickness 7mm

Fixing

Standard: D023 - 2 Zinc Plated Steel articulated (brackets for ceiling mounting included)

Rated voltages

Standard electronic ballast:
AC/DC 110-260V, 50-60Hz

Power factor

Up to 0.98

Cable entries

Standard: One entry M20
One cable gland (EXN04MMC2) - M20 Nickel Plated Brass for non-armoured cable, diameter 10-16mm

Terminal block (plug in terminal block)

Up to 6mm² (rigid wire), 4mm² (flexible wire)

Terminals supplied L, N, PE

Lamps (order separately)

T8 bi-pin G13 tube, Ø 26 - white industry 4000°K

G11 compact fluorescent PL lamp

Other options

Stainless steel shock proof kit 304L

Shock proof kit

See dimension column A

D036 - 1690mm

D035 - 1385mm

D034 - 780mm

Colour (standard)

● XFP***-0G000 - Yellow offshore, RAL 1003

Colour options

● XFP***-BG000 - Grey, RAL 7035

● XFP***-CG000 - Black, RAL 9004

● XFP***-DG000 - Hammered Blue, RAL 5015

● XFP***-FG000 - Red, RAL 3001

● XFP***-GG000 - Blue, RAL 5010

● XFP***-JG000 - Green, RAL 6032

○ XFP***-MG000 - White, RAL 9010

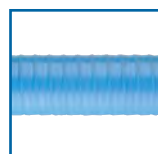

EXL Conduit 148



Stopping Plugs 174



GU Range 120



Ex d Cable Gland 162

Related Products

















XEL Range

Miniature tubular fluorescent fitting



Approvals / Characteristics

 
 

   
  Polycarbonate Version
  Glass Version

Features

- Manufactured from marine grade aluminium
- Supplied with offshore grade paint
- All components mounted on the gear tray for easy installation and maintenance
- Standard components used inside the body allowing reduced maintenance costs
- Available in polycarbonate (light, high impact resistant) or in glass (for specific chemical environment and paint shop for easy cleaning)
- Including accessories (cable gland & fixing brackets)

Certification & Standards

Approved to: EN60079-0, 60079-1, 60079-7, 60079-31
EC TYPE Examination Certificate:
 INERIS II ATEX 0051X
 Ex II 2 G
 Ex d IIC T6 Gb
 Ex II 2 D
 Ex tb IIIC T80°C Db IP66
Glow wire test: 960°C EN60598-2-22
Safe operating temperature range: -20°C to +55°C



The fixture is supplied with non-barrier cable glands. For installations in either Zone 1 or in the presence of Group IIC gases, barrier glands are required. Please refer to EN-60079-14

Dimensions

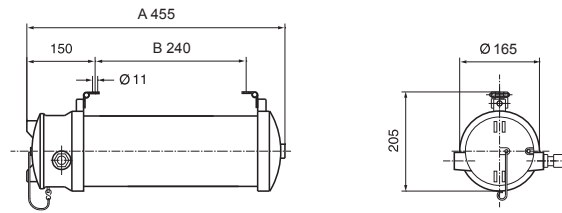

Technical Specifications

Type	Wiring Configuration	Rating (W)	Nominal Current (A)	Diffuser	Dimensions (mm)		Weight (kg)
					A	B	
XEL3008-0G000	5 Wire	1 x 8	0.1	Polycarbonate	455	240	5
XEL3009-0G000	5 Wire	1 x PL9	0.1	Polycarbonate	455	240	9
XEL30011-0G000	5 Wire	1 x PL11	0.1	Polycarbonate	455	240	5
XEL120-0G000	5 Wire	1 x PL18	0.3	Polycarbonate	455	240	4.5
XEL220-0G000	5 Wire	2 x PL18	0.5	Polycarbonate	455	240	5
XEL30028-0G000	5 Wire	2 x 8	0.1	Polycarbonate	455	240	5
XEL3008V-0G000	5 Wire	1 x 8	0.1	Glass	455	240	7
XEL3009V-0G000	5 Wire	1 x PL9	0.1	Glass	455	240	9
XEL30011V-0G000	5 Wire	1 x PL11	0.1	Glass	455	240	7
XEL120V-0G000	5 Wire	1 x PL18	0.3	Glass	455	240	6.5
XEL220V-0G000	5 Wire	2 x PL18	0.5	Glass	455	240	7
XEL30028V-0G000	5 Wire	2 x 8	0.1	Glass	455	240	7

Enclosure

End caps according to standard:
EN1706:EN AC-AISi12(Fe) DF or
EN AC-AISi10Mg(a) DF marine grade aluminium
UV protected extruded polycarbonate tube,
thickness 2.5mm
Borosilicate glass, thickness 7mm

Fixing

Standard: D023 - 2 Zinc Plated Steel articulated
(brackets for ceiling mounting included)

Rated voltages

Standard electronic ballast:
AC/DC 220-240V, 50-60Hz

Power factor

Up to 0.98

Cable entries

XEL: Two entries 3/4" NPT included
One 3/4" Nickel Plated Brass plug (EXN/075/SP)
One cable gland (EXN05AMC3) - 3/4" NPT Nickel
Plated Brass for non-armoured cable,
diameter 12-16mm

Terminal block

Up to 10mm² (rigid wire), 6mm² (flexible wire)
Terminals supplied L1, L2, L3, N, PE (looping possible
with 1 additional cable gland)

Lamps (order separately)

T5 bi-pin G5 tubes, Ø 16 coolwhite 4000°K
Compact fluorescent PL lamp with G11 base (18W)
or G23 (7W, 9W, 11W)

Colour (standard)

● XEL***-0G000 - Yellow offshore, RAL 1003

Colour options

- XEL***-BG000 - Grey, RAL 7035
- XEL***-CG000 - Black, RAL 9004
- XEL***-DG000 - Hammered Blue, RAL 5015
- XEL***-FG000 - Red, RAL 3001
- XEL***-GG000 - Blue, RAL 5010
- XEL***-JG000 - Green, RAL 6032
- XEL***-MG000 - White, RAL 9010

Spares & Fixings Accessories see pages 90-95



EXL Conduit 148



Stopping Plugs 174



GUV Range 120



Ex d Cable Gland 162

Related Products



XEP Range

Miniature tubular fluorescent fitting with automatic switch off



Approvals / Characteristics

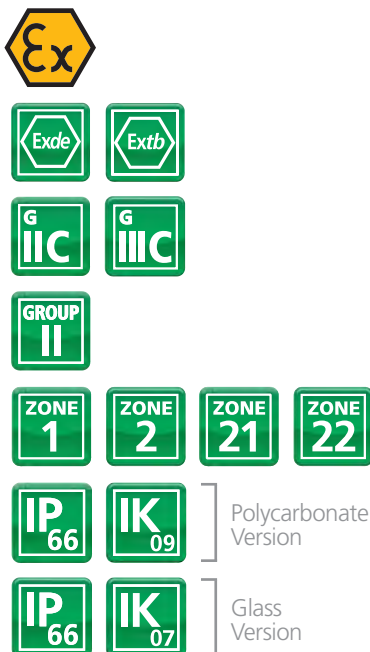

Features

- Manufactured from marine grade aluminium
- Supplied with offshore grade paint
- Maintenance in hazardous area - quick and easy isolation switch for safe maintenance in hazardous area
- All components mounted on the gear tray for easy installation and maintenance
- Standard components used inside the body allowing reduced maintenance costs
- Available in polycarbonate (light, high impact resistant) or in glass (specific chemical environment & paint shop)
- Including accessories (cable gland & fixing brackets)

Certification & Standards

Approved to: EN60079-0, 60079-1, 60079-7
 EC TYPE Examination Certificate:
 INERIS II ATEX 0052X
 Ex II 2 G
 Ex de IIC T6 Gb
 Ex II 2 D
 Ex tb IIIC T80°C Db IP66
 Glow wire test: 960°C EN60598-2-22
 Safe operating temperature range: -20°C to +55°C

Dimensions

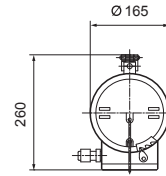
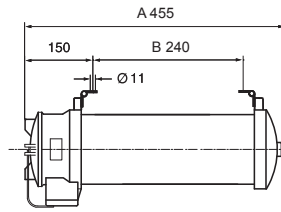

Technical Specifications

Type	Wiring Configuration	Rating (W)	Nominal Current (A)	Diffuser	Dimensions (mm)		Weight (kg)
					A	B	
XEP3008-0G000	3 Wire	1 x 8	0.1	Polycarbonate	455	240	5
XEP3009-0G000	3 Wire	1 x PL9	0.1	Polycarbonate	455	240	5
XEP30011-0G000	3 Wire	1 x PL11	0.1	Polycarbonate	455	240	5
XEP120-0G000	3 Wire	1 x PL18	0.3	Polycarbonate	455	240	4.5
XEP220-0G000	3 Wire	2 x PL18	0.5	Polycarbonate	455	240	5
XEP30028-0G000	3 Wire	2 x 8	0.1	Polycarbonate	455	240	5
XEP3008V-0G000	3 Wire	1 x 8	0.1	Glass	455	240	7
XEP3009V-0G000	3 Wire	1 x PL9	0.1	Glass	455	240	7
XEP30011V-0G000	3 Wire	1 x PL11	0.1	Glass	455	240	7
XEP120V-0G000	3 Wire	1 x PL18	0.3	Glass	455	240	6.5
XEP220V-0G000	3 Wire	2 x PL18	0.5	Glass	455	240	7
XEP30028V-0G000	3 Wire	2 x 8	0.1	Glass	455	240	7

Enclosure

End caps according to standard:
EN1706:EN AC-ALSi12(Fe) DF or
EN AC-ALSi10Mg(a) DF marine grade aluminium
UV protected extruded polycarbonate tube,
thickness 2.5mm
Borosilicate glass, thickness 7mm

Fixing

Standard: D023 - 2 Zinc Plated Steel articulated
(brackets for ceiling mounting included)

Rated voltages

Standard electronic ballast:
AC/DC 220-240V, 50-60Hz

Power factor

Up to 0.98

Cable entries

Standard: One M20 cable entry included
One cable gland (EXN04MMC2), Nickel Plated Brass
for non-armoured cable, diameter 10-16mm

Terminal block

Up to 6mm² (rigid wire), 4mm² (flexible wire)
Terminals supplied for L, N, PE

Lamps (order separately)

T5 bi-pin G5 tubes, Ø 16 coolwhite 4000°K
Compact fluorescent PL lamp with G11 base (18W)
or G23 (7W, 9W, 11W)

Colour (standard)

● XEP***-0G000 - Yellow offshore, RAL 1003

Colour options

- XEP***-BG000 - Grey, RAL 7035
- XEP***-CG000 - Black, RAL 9004
- XEP***-DG000 - Hammered Blue, RAL 5015
- XEP***-FG000 - Red, RAL 3001
- XEP***-GG000 - Blue, RAL 5010
- XEP***-JG000 - Green, RAL 6032
- XEP***-MG000 - White, RAL 9010

Spares & Fixings Accessories see pages 90-95



EXL Conduit 148



Stopping Plugs 174



GUV Range 120



Ex d Cable Gland 162

Related Products



XHM : Also available pre mounted
(see opposite for details)

XF Range Floodlight fittings



Approvals / Characteristics

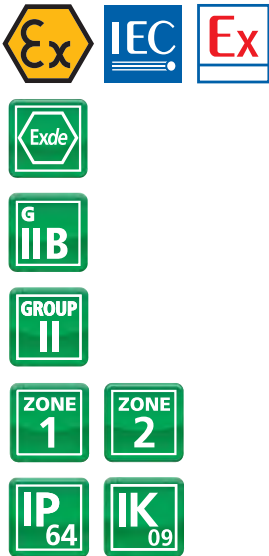

Features

- Compact, lightweight and robust
- Ex e integral junction box: easy connection
- Excellent photometric properties, wide or narrow beam
- Internationally recognised
- Supplied with lamp installed and cable gland
- Supplied with offshore grade paint

Certification & Standards

Approved to: EN60079-0, 60079-1, 60079-7
 EC TYPE Examination Certificate:
 LCIE 00 ATEX 6019X / IECEx LCI 11-0062X
 Ex II 2 G
 Ex de IIB T1 to T5 Gb for $\leq -20^{\circ}\text{C}$ to $\leq +60^{\circ}\text{C}$
 depending on model
 IP test: IP66 IEC 60529 (2001)

Dimensions

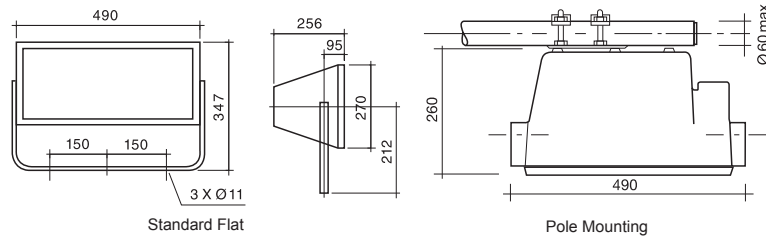

Technical Specifications

Type*	Mounting	Nominal Rating (W)	Nominal Current (A)	Temperature Class		Weight (kg)
				-20°C to +40°C	-20°C to +60°C	
XSF70P-00000	Flat	1 x 70W HP Sodium	0.4	T4	T3	17
XSF70G-00000	Pole	1 x 70W HP Sodium	0.4	T4	T3	17
XSF150P-00000	Flat	1 x 150W HP Sodium	0.8	T4	T3	17
XSF150G-00000	Pole	1 x 150W HP Sodium	0.8	T4	T3	17
XSF250P-00000	Flat	1 x 250W HP Sodium	1.3	T3	T3	18
XSF250G-00000	Pole	1 x 250W HP Sodium	1.3	T3	T3	18
XSF400P-00000	Flat	1 x 400W HP Sodium	2.1	T3	T2	20
XSF400G-00000	Pole	1 x 400W HP Sodium	2.1	T3	T2	20
XQF250P-00000	Flat	1 x 250W Metal Halide	1.3	T3	T2	20
XQF250G-00000	Pole	1 x 250W Metal Halide	1.3	T3	T3	18
XQF400P-00000	Flat	1 x 400W Metal Halide	2.1	T3	T3	18
XQF400G-00000	Pole	1 x 400W Metal Halide	2.1	T3	T2	20
XEF110P-00000	Flat	2 x 55W Halogen (12V)	9.2	T5	T5	13
XEF110G-00000	Pole	2 x 55W Halogen (12V)	9.2	T5	T5	13
XEF140P-00000	Flat	2 x 70W Halogen (24V)	5.8	T5	T5	13
XEF140G-00000	Pole	2 x 70W Halogen (24V)	5.8	T5	T5	13

*X... F... -0A000 (to complete with nominal rating & mounting) - Narrow beam, for example XQF400P-0A000

Enclosure

Marine grade aluminium alloy type according to EN1706:EN AC-AISI7 Mg 0,6 T6
Cathodically treated
12mm toughened glass

Rated voltages

Version HPS/metal halide:

Standard: 230V 50Hz ferromagnetic ballast, with capacitor

Option: ferromagnetic ballast

- 220V 60Hz

- 120V 60Hz on few models

Power factor

Up to 0.85 for version with compensated ballast (Sodium HP and metal halide)

Cable entries

Standard: Two entries M20 included

One plug (EXN/M20/HSP) and one cable gland (EXN04MMC2) - Nickel Plated Brass ISO M20 for non-armoured cable, diameter 10-16mm

Terminal block

Up to 6mm² (rigid wire), 4mm² (flexible wire)

Terminal supplies for L, N, PE

Lamps (Installed)

Polished aluminium reflector

Standard: wide beam

Option: narrow beam

Fixing

Standard: galvanised steel flat mounting bracket,

yellow polyester paint RAL1003

Pole mounted: Ø 40 to 60mm

Other options

Sling (SC100 ELINGUE)

FC 108 (CLAMP FOR BEAM MOUNTING)

SC 100 (SAFETY HARNESS)

SA 103 (Jobsite option)

Galvanised steel support with base plate (SA103)

XHM... Pre wired masthead floodlighting systems:

Full system with 2 or 4 floodlights

For example XHM 4400 (4 x 400 W HPS)

(to complete with nominal rating)

Colour (standard)

● X****-00000 - Yellow offshore, RAL 1003

Colour option

● X****-B0000 - Grey, RAL 7035

● X****-C0000 - Black, RAL 9004

● X****-D0000 - Hammered Blue, RAL 5015

● X****-F0000 - Red, RAL 3001

● X****-G0000 - Blue, RAL 5010

● X****-J0000 - Green, RAL 6032

○ X****-M0000 - White, RAL 9010

Spares & Fixings Accessories see pages 90-95



EXL Conduit 148



Stopping Plugs 176



GUV Range 120



Ex e Cable Gland 166

Related Products



XFB / XFL Range

Warning lights and beacons



Approvals / Characteristics

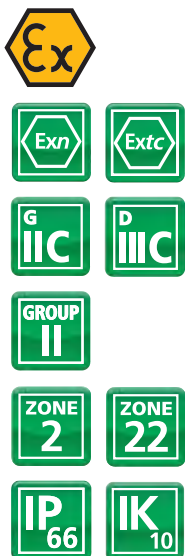

Features

- Lightweight and robust for easy installation
- Static or flashing versions available for use in a variety of applications
- Choice of 5 colours of globe
- 2 or 3 light versions available for traffic signals
- Supplied with single cable gland and lamps installed
- Including accessories (cable gland, plug & lampstand)

Certification & Standards

Approved to: EN60079-0, 60079-15, 60079-31
 EC TYPE Examination Certificate:
 Ex II 3 G / D
 Ex nA IIC T5 Gc
 Ex tc IIC T100°C Dc IP66 for ≤ -20°C to ≤ +60°C

Dimensions

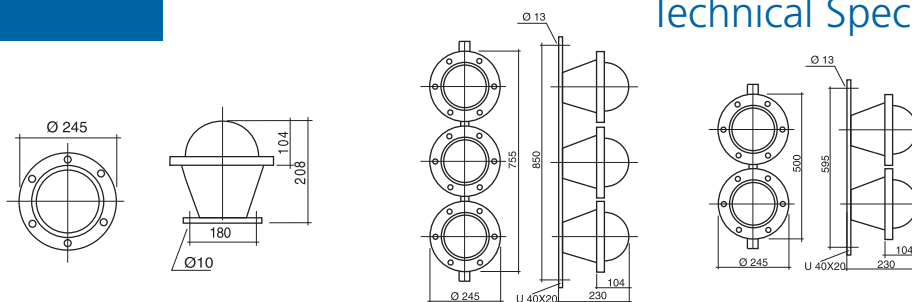

Technical Specifications

Type	Rating (W)	Lamp	Globe Colour*	Version	Rated Voltages	Weight (kg)
XFB30-00000	1 x 28	E27	Red	Halogen	AC 230V 50/60Hz	3.5
XFB70-00000	1 x 8	E27	Red	LED	AC 100-240V 50/60Hz	3.5
XFL30P-00000	30 Joules	Picots	Red	Xenon flash	AC 230V 50/60Hz	4
XFL30P-0C000	30 Joules	Picots	Red	Xenon flash	AC 100V 50/60Hz	4
XFL30P-0D000	30 Joules	Picots	Red	Xenon flash	DC 24V	4
XFL30P-0E000	30 Joules	Picots	Red	Xenon flash	DC 48V	4
XFL30P-0F000	30 Joules	Picots	Red	Xenon flash	DC 110V	4
XFB230-00000	2 x 28	E27	Red / Green	Halogen	AC 230V 50/60Hz	7
XFB270-00000	2 x 8	E27	Red / Green	LED	AC 100-240V 50/60Hz	7
XFL230-00000	2 x 30 Joules	Picots	Red / Green	Xenon Flash	AC 230V 50/60Hz	8
XFL230-0C000	2 x 30 Joules	Picots	Red / Green	Xenon Flash	AC 100V 50/60Hz	8
XFL230-0D000	2 x 30 Joules	Picots	Red / Green	Xenon Flash	DC 24V 50/60Hz	8
XFL230-0E000	2 x 30 Joules	Picots	Red / Green	Xenon Flash	DC 48V 50/60Hz	8
XFL230-0F000	2 x 30 Joules	Picots	Red / Green	Xenon Flash	DC 110V 50/60Hz	8
XFB330-00000	3 x 28	E27	Red / Yellow / Green	Halogen	AC 230V 50/60Hz	10.5
XFB370-00000	3 x 8	E27	Red / Yellow / Green	LED	AC 100-240V 50/60Hz	10.5
XFL330-00000	3 x 30 Joules	Picots	Red / Yellow / Green	Xenon Flash	AC 230V 50/60Hz	12
XFL330-0C000	3 x 30 Joules	Picots	Red / Yellow / Green	Xenon Flash	AC 100V 50/60Hz	12
XFL330-0D000	3 x 30 Joules	Picots	Red / Yellow / Green	Xenon Flash	DC 24V	12
XFL330-0E000	3 x 30 Joules	Picots	Red / Yellow / Green	Xenon Flash	DC 48V	12
XFL330-0F000	3 x 30 Joules	Picots	Red / Yellow / Green	Xenon Flash	DC 110V	12

*Choice of globe colours: XF...-00000 - Red, XF...-000A0 - Transparent globe, XF...-000B0 - Green globe, XF...-000C0 - Orange globe, XF...-000D0 - Blue globe

**Colour combination: please contact Sales for more information

Enclosure

Marine grade aluminium alloy type
EN1706 AC-43100KF-AISI 10Mg
Aluminium reflector

Temperature

Ambient temperature: -20°C to +60°C

Cable entries

Standard: Two entries M20 included
One Nickel Plated Brass plug (EXN/M20/HSP) and one cable gland (EXN04MMC2) - Nickel Plated Brass
ISO M20 for non-armoured cable, diameter 10-16mm

Terminal block

Up to 6mm²
Terminals supplied for L, N, PE

Lamps (supplied)

For xenon flash versions
Flashing rate: 45 to 60 - per minute

Globe

Polycarbonate, thickness 3mm

Colour (standard)

● XF****-00000 - Yellow offshore, RAL 1003

Colour options

- XF****-B0000 - Grey, RAL 7035
- XF****-C0000 - Black, RAL 9004
- XF****-D0000 - Hammered Blue, RAL 5015
- XF****-F0000 - Red, RAL 3001
- XF****-G0000 - Blue, RAL 5010
- XF****-J0000 - Green, RAL 6032
- XF****-M0000 - White, RAL 9010

Spares & Fixings Accessories see pages 90-95

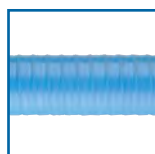

EXL Conduit 148



Stopping Plugs 176



GUV Range 120



Thread Convertors 170

Related Products



XDF Range Drilling fluorescent fitting



Approvals / Characteristics

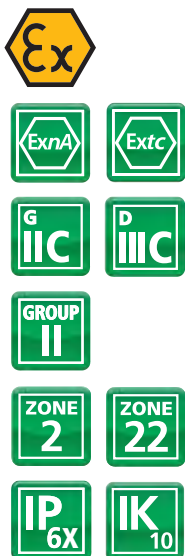

Features

- Vibration resistant lighting system
- Plug in system for fast installation
- Designed to minimise heat build up and overheating
- Corrosion resistant ideal for marine applications
- Hazardous and safe area versions available
- Including accessories (socket, plug, fixation & cable)
- Supplied with offshore grade paint

Certification & Standards

Approved to: EN60079-0, 60079-15
 EC TYPE Examination Certificate:
 Ex II 3 G / D
 Ex nA IIC T4 Gc
 Ex tc IIIC T135°C Dc IP6X
 Temperature range: -20°C to +60°C

Dimensions

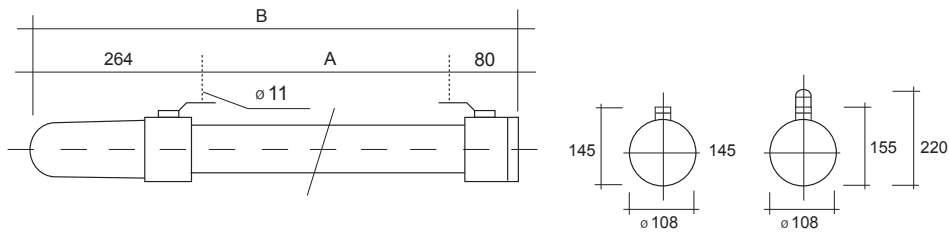

Technical Specifications

Type	Rated Voltage	Rating (W)	Nominal Current (A)	Diffuser	A	B	Weight (kg)
XDF140-00000	230V 50Hz	1 x 36	0.20	Polycarbonate	1173	1540	8.5
XDF165-00000	230V 50Hz	1 x 58	0.35	Polycarbonate	1474	1841	9
XDF140-0D000	220V 60Hz	1 x 36	0.20	Polycarbonate	1173	1540	8.5
XDF165-0D000	220V 60Hz	1 x 58	0.35	Polycarbonate	1474	1841	9

Enclosure

End caps according to standard:
 EN1706:EN AC-AISI12(Fe) DF or
 EN AC-AISI10Mg(a) DF marine grade aluminium
 Including offshore option
 Yellow offshore polyurethane paint RAL 1003
 UV protected extruded polycarbonate tube,
 thickness 2.5mm

Rated voltages

Ferromagnetic ballast

Cable entries

Standard: Two M20 cable entries
 Supplied with:
 One plug entry: male - 2 poles & earth -
 10Amp - 250VAC
 One socket entry: female - 2 poles & earth -
 10 Amp - 250VAC
 One extendable cable with male plug and female
 socket (Helical cable) expandable to 5 metre max

Terminal block (plug in terminal block)

Up to 6mm²

Terminals supplied L, N, PE

Lamps (order separately)

T8 bi-pin G13 tube, Ø 26 - white industry 4000°K

Fixing (included)

2 Brackets for beam clamp fixing

Other options

Other voltage ratings: on request

Wiring Diagram

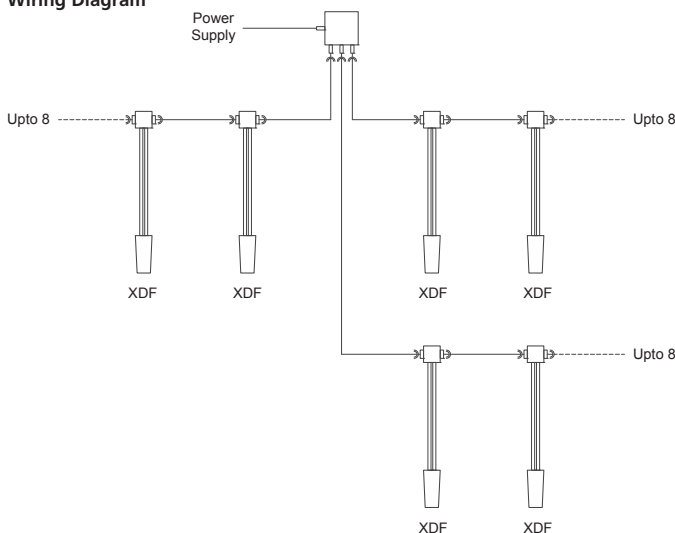

Must be used with XD104R - Junction box

For 3 x 8 = 24 light fitting

Contact Sales for further details

Spares & Fixings Accessories see pages 90-95



EXL Conduit 148



Stopping Plugs 176



GUV Range 120

Related Products



EVS Range

Fluorescent fitting with easy disconnect



Approvals / Characteristics

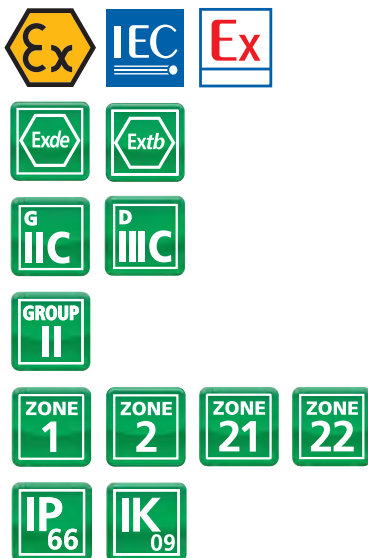

Features

- Easy disconnecter for safer maintenance out of zones
- Double central locking for ingress protection
- Main body constructed of a GRP for high impact strength
- Polycarbonate diffuser to resist harsh environments
- Automatic switch off upon opening for safe maintenance
- All components mounted on hinged and removable gear tray which gives easy access for maintenance
- Including accessories (cable gland & fixing brackets)

Certification & Standards

Approved to: EN60079-0, 60079-1, 60079-5, 60079-7, 60079-31
 EC TYPE Examination Certificate:
 LCIE 11 ATEX 3065X
 IEC Ex LCI 11.0053X
 Ex II 2 G
 Ex de IIC T4 Gb for $\leq -40^{\circ}\text{C}$ to $\leq +60^{\circ}\text{C}$
 Ex de IIC T5 Gb for $\leq -40^{\circ}\text{C}$ to $\leq +35^{\circ}\text{C}$
 Ex II 2 D
 Ex tb IIC T85°C Db IP6X
 Glow wire test: 960°C EN60598-2-22
 Safe operating temperature range: -20°C to +50°C
 IP test: IP66 IEC 60529 (2001)

Dimensions

Technical Specifications

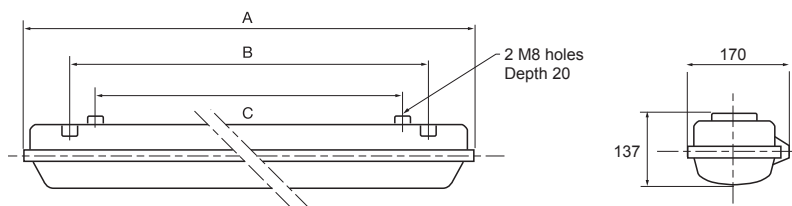

Type*	Wiring Configuration	Rating (W)	Nominal Current (A)	Dimensions (mm)			Weight (kg)
				A	B	C	
EVS120-0000	5 Wire Loop	1 x 18	0.09	785	432	400	5.5
EVS120-D000	5 Wire & Continuity plate	1 x 18	0.09	785	432	400	5.5
EVS140-0000	5 Wire Loop	1 x 36	0.17	1370	900	700	7.5
EVS140-D000	5 Wire & Continuity plate	1 x 36	0.17	1370	900	700	7.5
EVS165-0000	5 Wire Loop	1 x 58	0.26	1670	900	700	9
EVS165-D000	5 Wire & Continuity plate	1 x 58	0.26	1670	900	700	9
EVS220-0000	5 Wire Loop	2 x 18	0.17	785	432	400	6.5
EVS220-D000	5 Wire & Continuity plate	2 x 18	0.17	785	432	400	6.5
EVS240-0000	5 Wire Loop	2 x 36	0.33	1370	900	700	8.5
EVS240-D000	5 Wire & Continuity plate	2 x 36	0.33	1370	900	700	8.5
EVS265-0000	5 Wire Loop	2 x 58	0.5	1670	900	700	10
EVS265-D000	5 Wire & Continuity plate	2 x 58	0.5	1670	900	700	10

**(Through options) Define type rating: EVS...-B000 5 wires through (to complete with nominal rating), EVS...-E000 5 wires through & 2 continuity plates (to complete with nominal rating)*

Enclosure

Fiberglass reinforced polyester body
Polycarbonate diffuser, treated against UV

Fixing

Standard: V015 - 2 Zinc Plated Steel brackets for ceiling mounting

Rated voltages

Standard: electronic ballast
AC/DC 220-240V, 50/60Hz
Contact Sales Office for other voltage options

Power factor

Up to 0.98

Cable entries

Standard: Three M20 entries included
Two M20 Nylon plugs (EX-M20)
One cable gland (EXCGM20S) - ISO M20 Nylon for non-armoured cable, diameter 6-12mm
For armoured cable - continuity plate option:
Nickel Plated Brass cable gland (EXN04MMC1), diameter 6-12 / 8.5-16mm (1 or 2 according to number of plates)

Terminal block

Up to 4mm² (rigid wire), 2.5mm² (flexible wire)
Wiring L1, L2, L3, N, PE (5 wires)
5 wires through option: I max = 16 A max.
Lamps (order separately)
Tube G13 bi-pin T8 Ø 26 coolwhite 4000°k

Spares & Fixings Accessories see pages 90-95



EXB Conduit 138



Nylon Stopping Plugs 176



XB100 Range 104



Exe Nylon Gland 168

Related Products



EVN Range Fluorescent fitting with diffuser



Approvals / Characteristics



Features

- Double central locking for ingress protection
- Main body constructed of a GRP for high impact strength
- Polycarbonate diffuser to resist harsh and corrosive environments
- All components mounted on hinged and removable gear tray which gives easy access for installation and maintenance
- Including accessories (cable gland & fixing brackets)
- Option: automatic switch off on opening

Certification & Standards

Approved to: EN60079-0, 60079-15, EN60079-31
 EC TYPE Examination Certificate: Under new 94/9/EC self certified
 Ex II 3 G
 Ex nr IIC T4 Gb for $\leq -40^{\circ}\text{C}$ to $\leq +60^{\circ}\text{C}$
 Ex nr IIC T5 Gb for $\leq -40^{\circ}\text{C}$ to $\leq +35^{\circ}\text{C}$
 Ex II 3 D
 Ex tc IIIC T85°C Db IP66
 Glow wire test: 960°C EN60598-2-22
 Safe operating temperature range: -20°C to $+50^{\circ}\text{C}$
 IP test: IP66 IEC 60529 (2001)

Dimensions

Technical Specifications

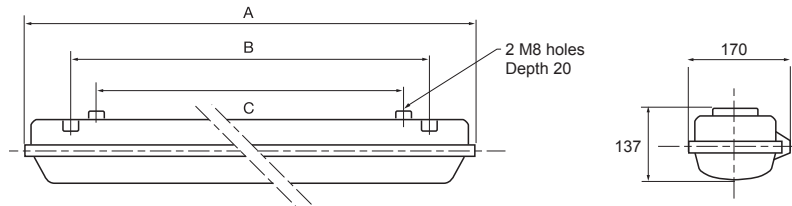

Type*	Wiring Configuration	Rating (W)	Nominal Current (A)	Dimensions (mm)			Weight (kg)
				A	B	C	
EVN120-0000	5 Wire Loop	1 x 18	0.17	785	432	400	4.2
EVN120-D000	5 Wire & Continuity plate	1 x 18	0.17	785	432	400	4.2
EVN140-0000	5 Wire Loop	1 x 36	0.17	1370	900	700	6.5
EVN140-D000	5 Wire & Continuity plate	1 x 36	0.17	1370	900	700	6.5
EVN165-0000	5 Wire Loop	1 x 58	0.26	1670	900	700	8
EVN165-D000	5 Wire & Continuity plate	1 x 58	0.26	1670	900	700	8
EVN220-0000	5 Wire Loop	2 x 18	0.17	785	432	400	4.5
EVN220-D000	5 Wire & Continuity plate	2 x 18	0.17	785	432	400	4.5
EVN240-0000	5 Wire Loop	2 x 36	0.33	1370	900	700	6.8
EVN240-D000	5 Wire & Continuity plate	2 x 36	0.33	1370	900	700	6.8
EVN265-0000	5 Wire Loop	2 x 58	0.5	1670	900	700	8.5
EVN265-D000	5 Wire & Continuity plate	2 x 58	0.5	1670	900	700	8.5

*(Through options) Define type rating: EVN...-B000 5 wires through (to complete with nominal rating), EVN...-E000 5 wires through & 2 continuity plates (to complete with nominal rating)

Enclosure

Fiberglass reinforced polyester body
Polycarbonate diffuser, treated against UV

Fixing

Standard: V015 - 2 Zinc Plated Steel brackets for ceiling mounting

Rated voltages

Standard: electronic ballast
AC/DC 110-260V, 50-60Hz
Contact Sales Office for other voltage options

Power factor

Up to 0.98

Cable entries

Standard: Three M20 entries included
Two M20 Nylon plugs (EX-M20)
One cable gland (EXCGM20S) - ISO M20 Nylon for non-armoured cable, diameter 6-12mm
For armoured cable - continuity plate option:
Nickel Plated Brass cable gland (EXN04MMC1), diameter 6-12 / 8.5-16mm (1 or 2 according to number of plates)

Terminal block

Up to 6mm² (rigid wire), 4mm² (flexible wire)
Wiring L1, L2, L3, N, PE (5 wires)
5 wire through option: I max 16 A
Lamps (order separately)
Tube G13 bi-pin T8 Ø 26 coolwhite 4000°k

Spares & Fixings Accessories see pages 90-95



EXB Conduit 138



Nylon Stopping Plugs 176



XB100 Range 104



Exe Nylon Gland 168

Related Products



EVD Range

Fluorescent fitting - developed for dust environment



Approvals / Characteristics

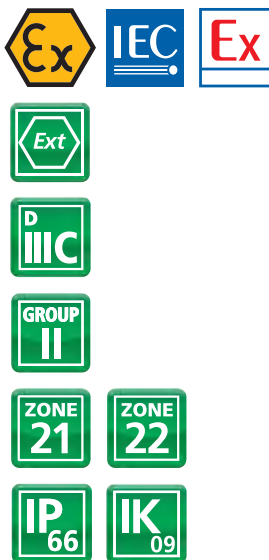

Features

- Double central locking for ingress protection
- Main body constructed of a GRP for high impact strength
- Polycarbonate diffuser to resist harsh and corrosive environments
- All components mounted on hinged and removable gear tray which gives easy access for installation and maintenance
- Including accessories (cable gland & fixing brackets)
- Option: automatic switch off on opening

Certification & Standards

Approved to: EN60079-0, 60079-31
 EC TYPE Examination Certificate:
 LCIE II ATEX 3092X
 IECEx LCI 11.0064X
 Ex II 2 D
 Ex t IIIC T82°C (≤ +60°C) Db
 Ex t IIIC T62°C (≤ +40°C) Db
 Glow wire test: 960°C EN60598-2-22
 Safe operating temperature range: -20°C to +50°C
 IP test: IP66 IEC 60529 (2001)

Dimensions

Technical Specifications

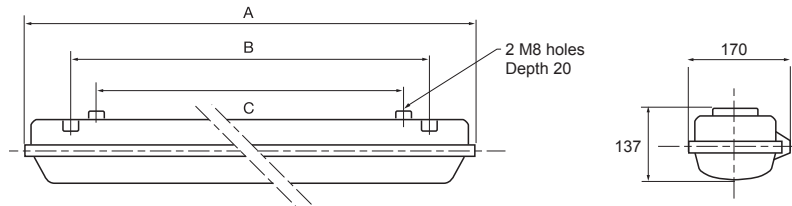

Type*	Wiring Configuration	Rating (W)	Nominal Current (A)	Dimensions (mm)			Weight (kg)
				A	B	C	
EVD120-00J0	5 Wire Loop	1 x 18	0.09	785	432	400	4.2
EVD120-D0J0	5 Wire & Continuity plate	1 x 18	0.09	785	432	400	4.2
EVD140-00J0	5 Wire Loop	1 x 36	0.17	1370	900	700	6.5
EVD140-D0J0	5 Wire & Continuity plate	1 x 36	0.17	1370	900	700	6.5
EVD165-00J0	5 Wire Loop	1 x 58	0.26	1670	900	700	8
EVD165-D0J0	5 Wire & Continuity plate	1 x 58	0.26	1670	900	700	8
EVD220-00J0	5 Wire Loop	2 x 18	0.17	785	432	400	4.5
EVD220-D0J0	5 Wire & Continuity plate	2 x 18	0.17	785	432	400	4.5
EVD240-00J0	5 Wire Loop	2 x 36	0.33	1370	900	700	6.8
EVD240-D0J0	5 Wire & Continuity plate	2 x 36	0.33	1370	900	700	6.8
EVD265-00J0	5 Wire Loop	2 x 58	0.5	1670	900	700	8.5
EVD265-D0J0	5 Wire & Continuity plate	2 x 58	0.5	1670	900	700	8.5

**(Through options) EVD...-B0J0 - 5 Wires through (to complete with rating)*

EVD...-E0J0 - 5 wires through & 2 continuity plates (to complete with rating)

EVD...-0C0 - Automatic switch off on opening including electronic ballast (to complete with rating & wiring configuration)

Enclosure

Fiberglass reinforced polyester body
Polycarbonate diffuser, treated against UV

Fixing

Standard: V015 - 2 Zinc Plated Steel brackets for ceiling mounting

Rated voltages

Standard: electronic ballast
AC/DC 110-260V, 50-60Hz
Contact Sales Office for other voltage options

Power factor

Up to 0.98

Cable entries

Standard: Three M20 cable entries included
Two M20 Nylon plugs and
One cable gland (EXCGM20S) - ISO M20 Nylon for non-armoured cable, diameter 6-12mm
For armoured cable - continuity plate option:
Nickel Plated Brass cable gland (EXN04MMC1), diameter 6-12 / 8.5-16mm (1 or 2 according to number of plates)

Terminal block

Up to 6mm² (rigid wire), 4mm² (flexible wire)
Terminals supplied for L1, L2, L3, N, PE
5 wires through option: I max 16 A

Lamps (order separately)

Tube G13 bi-pin T8 Ø 26 coolwhite 4000°k

Spares & Fixings Accessories see pages 90-95



EXB Conduit 138



Nylon Stopping Plugs 176



XB100 Range 104



Exe Nylon Gland 168

Related Products



ESB Range Recessed fluorescent fitting



Approvals / Characteristics



Features

- Main body made from powder coated steel
- 6mm toughened glass making it perfect for laboratories
- Automatic switch off upon opening for safe maintenance
- Including accessories (cable gland)

Certification & Standards

Approved to: EN60079-0, 60079-1, 60079-7
 EC TYPE Examination Certificate: Under 94/9/EC
 INERIS II ATEX 0058X
 Ex II 2 G
 Ex de IIC T4 Gb for $\leq -20^{\circ}\text{C}$ to $\leq +40^{\circ}\text{C}$
 Glow wire test: 850°C EN60598-2-22
 Safe operating temperature range: -20°C to $+40^{\circ}\text{C}$
 IP test: IP64 IEC 60529 (2001)

Dimensions

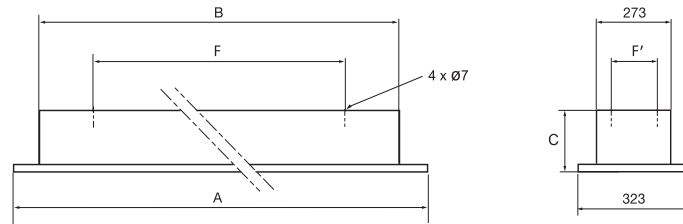

Technical Specifications

Type	Wiring Configuration	Rating (W)	Nominal Current (A)	Glass	Dimensions (mm)			F x F'	Weight (kg)
					A	B	C		
ESB220-0000	5 Wire	2 x 18	0.17	Toughened	753	702	105	400 x 240	12.5
ESB220-A000	5 Wire	2 x 18	0.17	Frosted	753	702	105	400 x 240	12.5
ESB240-0000	5 Wire	2 x 36	0.33	Toughened	1364	1312	105	1000 x 240	20
ESB240-A000	5 Wire	2 x 36	0.33	Frosted	1364	1312	105	1000 x 240	20
ESB265-0000	5 Wire	2 x 58	0.5	Toughened	1664	1612	105	1300 x 240	25
ESB265-A000	5 Wire	2 x 58	0.5	Frosted	1664	1612	105	1300 x 240	25

Enclosure

Steel housing and body painted in white polyester powderpaint RAL 9016
6mm clear toughened glass panel (optional frosted low lumen output)
Neoprene gasket

Rated voltages

Standard: electronic ballast
AC/DC 220-240V, 50-60Hz
Contact sales office for other voltages

Power factor

Up to 0.98

Cable entries

Two M20 cable entries included
One M20 Nylon stopping plug and
One cable gland (EXCGM20S) - ISO M20 Nylon for non-armoured cable, diameter 6-12mm
One M20 Nylon stopping plug (EX-M20)

Terminal block

Up to 4mm² (rigid wire), 2.5mm² (flexible wire)
Terminals supplied for L1, L2, L3, N, PE

Lamps (order separately)

Tube G13 bi-pin T8 Ø 26 coolwhite 4000°k

Fixing

Fixing by 4 M6 threaded bolts (not supplied) joined to the main body

Spares & Fixings Accessories see pages 90-95



EXB Conduit 138



Nylon Stopping Plugs 176



XB100 Range 104



Exe Nylon Gland 168

Related Products



XFF-EM Range Emergency tubular fluorescent fitting



Approvals / Characteristics

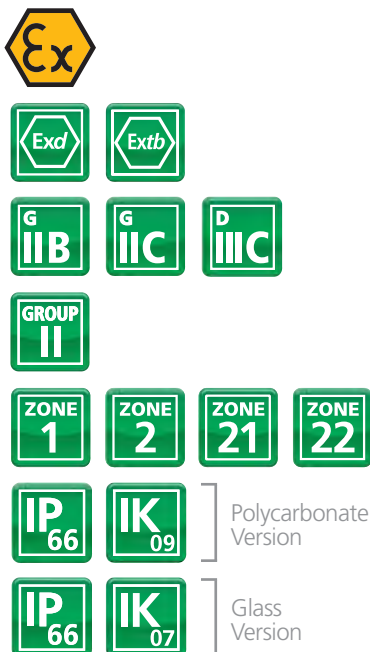

Features

- Manufactured from marine grade aluminium
- Supplied with offshore grade paint
- All components mounted on the gear tray for easy installation and maintenance
- Standard components used inside the body allowing reduced maintenance costs
- Available in polycarbonate (light, high impact resistant) or in glass (specific chemical environment & paint shop)
- Battery duration 2 hours
- Including accessories (cable gland & fixing brackets)

Certification & Standards

Approved to: EN60079-0, 60079-1, 60079-31
 EC TYPE Examination Certificate:
 INERIS 11 ATEX 0051X
 Ex II 2 G
 Ex d IIC T6 Gb for ≤ -20°C to ≤ +55°C (All Polycarbonate tubes)
 Ex d IIC T6 Gb for ≤ -20°C to ≤ +55°C (Glass tubes)
 Ex d IIB T6 Gb for ≤ -20°C to ≤ +55°C (Glass versions - XFR140EM and XFF240EM)
 Ex II 2 D
 Ex tb IIC T80°C Db IP66
 Glow wire test: 960°C EN60598-2-22
 Safe operating temperature range: -10°C to +40°C



The fixture is supplied with non-barrier cable glands. For installations in either Zone 1 or in the presence of Group IIC gases, barrier glands are required. Please refer to EN-60079-14

Ex Emergency lighting - XFF-EM Range

Dimensions

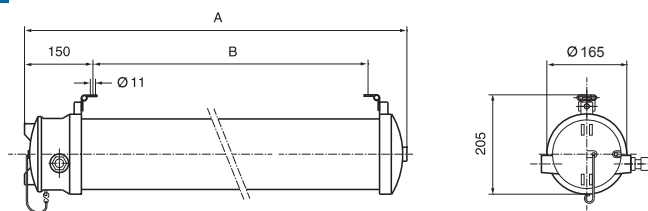

Technical Specifications

Type	Wiring Configuration	Rating (W)	Battery	Diffuser	Dimensions (mm)		Weight (kg)
					A	B	
XFR120EM-0G000	3 Wire	1 x 18	2h	Polycarbonate	780	565	7.5
XFR140EM-0G000	3 Wire	1 x 36	2h	Polycarbonate	1385	1170	9.5
XFF220EM-0G000	3 Wire	2 x 18	2h	Polycarbonate	780	565	7.5
XFF240EM-0G000	3 Wire	2 x 36	2h	Polycarbonate	1385	1170	9.5
XFR120VEM-0G000	3 Wire	1 x 18	2h	Glass	780	565	9.5
XFR140VEM-0G000	3 Wire	1 x 36	2h	Glass	1385	1170	9.5
XFF220VEM-0G000	3 Wire	2 x 18	2h	Glass	780	565	9.5
XFF240VEM-0G000	3 Wire	2 x 36	2h	Glass	1385	1170	9.5

Enclosure

End caps and cover in marine grade aluminium alloy type EN 1706 EN AC-AISI12(Fe) DF or EN AC-AISI10 Mg(a) DF

Yellow offshore polyurethane paint RAL 1003
UV protected extruded polycarbonate tube, thickness 2.5mm

Borosilicate glass, thickness 7mm

Fixing

Standard: D023 - 2 Zinc Plated Steel articulated brackets for ceiling mounting

For wiring, please refer to the instruction manual (drawings)

Technical assistance on request

Rated voltages

Electronic ballast:
XFF/XFR: AC/DC 220-240V, 50-60Hz

Power factor

Up to 0.98

Cable entries

Standard: Two entries 3/4" NPT included
One 3/4" Nickel Plated Brass plug (EXN075/SP)
One cable gland (EXN05AMC3)- 3/4" NPT Nickel Plated Brass for non-armoured cable, diameter 12-16mm

Battery

Lumen output in emergency mode (1 tube lit)
40% for 18W
33% for 40W

Terminal block (plug in terminal block)

Up to 10mm² (rigid wire), 6mm² (flexible wire)
Supplied L1, 2, N, PE Terminals
Looping possible with additional cable gland
Select function: Lighting in maintained mode or lighting in non-maintained mode

Lamps (order separately)

T8 bi-pin G13 tube, Ø 26 - white industry 4000°K (order separately)

T5 bi-pin 65 supplied with XEL

Other options

Stainless steel shockproof kit 304L

Colour (standard)

● X*****-0G000 - Yellow offshore, RAL 1003

Colour options

● X*****-BG000 - Grey, RAL 7035

● X*****-CG000 - Black, RAL 9004

● X*****-DG000 - Hammered Blue, RAL 5015

● X*****-FG000 - Red, RAL 3001

● X*****-GG000 - Blue, RAL 5010

● X*****-JG000 - Green, RAL 6032

○ X*****-MG000 - White, RAL 9010

Spares & Fixings Accessories see pages 90-95

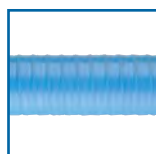

EXL Conduit 148



Stopping Plugs 174



GU Range 120



Ex d Cable Gland 162

Related Products



XFP-EM Range

Emergency tubular fluorescent fitting with automatic switch off



Approvals / Characteristics

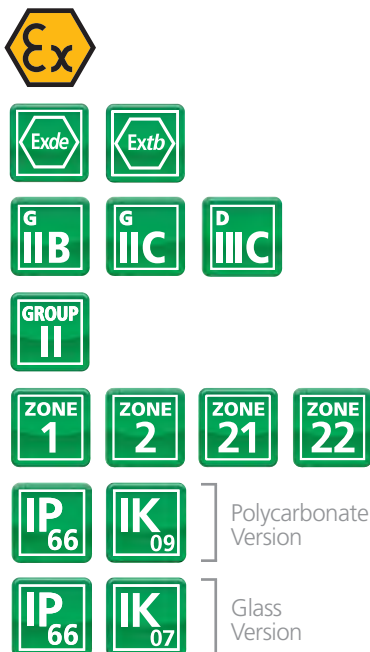

Features

- Manufactured from marine grade aluminium
- Supplied with offshore grade paint
- Maintenance in hazardous area is quick and easy with isolation switch for safe maintenance
- All components mounted on the gear tray for easy installation and maintenance
- Standard components used inside the body allowing reduced maintenance costs
- Available in polycarbonate (light, high impact resistant) or in glass (specific chemical environment & paint shop)
- Battery duration 2 hours
- Including accessories (cable gland & fixing brackets)

Certification & Standards

Approved to: EN60079-0, 60079-1, 60079-7, 60079-31
 EC TYPE Examination Certificate:
 INERIS 11 ATEX 0052X
 Ex II 2 G
 Ex de IIC T6 Gb for $\leq -20^{\circ}\text{C}$ to $\leq +55^{\circ}\text{C}$ (All Polycarbonate tubes)
 Ex de IIC T6 Gb for $\leq -20^{\circ}\text{C}$ to $\leq +55^{\circ}\text{C}$ (Glass tubes)
 Ex de IIB T6 Gb for $\leq -20^{\circ}\text{C}$ to $\leq +55^{\circ}\text{C}$ (Glass versions - XFP140EM and XFP240EM)
 Ex II 2 D
 Ex tb IIC T80°C Db IP66
 Glow wire test: 960°C EN60598-2-22
 Safe operating temperature range: -10°C to $+40^{\circ}\text{C}$

Ex Emergency lighting - XFP-EM Range

Dimensions

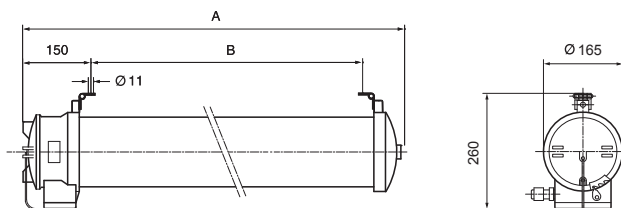

Technical Specifications

Type	Wiring Configuration	Rating (W)	Battery	Diffuser	Dimensions (mm)		Weight (kg)
					A	B	
XFP120EM-0G000	3 Wire	1 x 18	2h	Polycarbonate	780	565	7.5
XFP140EM-0G000	3 Wire	1 x 36	2h	Polycarbonate	1385	1170	9.5
XFP220EM-0G000	3 Wire	2 x 18	2h	Polycarbonate	780	565	7.5
XFP240EM-0G000	3 Wire	2 x 36	2h	Polycarbonate	1385	1170	9.5
XFP120VEM-0G000	3 Wire	1 x 18	2h	Glass	780	565	9.5
XFP140VEM-0G000	3 Wire	1 x 36	2h	Glass	1385	1170	11
XFP220VEM-0G000	3 Wire	2 x 18	2h	Glass	780	565	9.5
XFP240VEM-0G000	3 Wire	2 x 36	2h	Glass	1385	1170	11

Enclosure

End caps and cover in marine grade aluminium alloy type EN1706:EN AC-ALSi12(Fe) DF or EN AC-ALSi10 Mg(a) DF

UV protected extruded polycarbonate tube, thickness 2.5mm

Borosilicate glass, thickness 7mm

Fixing

Standard: D023 - 2 Zinc Plated Steel articulated brackets for ceiling mounting

For wiring, please refer to the instruction manual (drawings)

Technical assistance on request

Rated voltages

Standard: electronic ballast:
AC/DC 220-240V, 50-60Hz

Power factor

Up to 0.98

Cable entries

Standard M20 cable entry included
One cable gland (EXN04MMC2) - Nickel Plated Brass M20 for non-armoured cable, diameter 10-16mm

Battery

Lumen output in emergency mode (1 tube lit)
40% for 18W
33% for 33W
Monitored by one LED

Terminal block (plug in terminal block)

Up to 6mm² (rigid wire), 4mm² (flexible wire)
Supplied L1, 2, N, PE Terminals

Select function: Lighting in maintained mode or lighting in non-maintained mode

Lamps (order separately)

T8 bi-pin G13 tube, Ø 26 - white industry 4000°K

Other options

Stainless steel shockproof kit 304L

Colour (standard)

● XFP***-0G000 - Yellow offshore, RAL 1003

Colour options

● XFP***-BG000 - Grey, RAL 7035

● XFP***-CG000 - Black, RAL 9004

● XFP***-DG000 - Hammered Blue, RAL 5015

● XFP***-FG000 - Red, RAL 3001

● XFP***-GG000 - Blue, RAL 5010

● XFP***-JG000 - Green, RAL 6032

○ XFP***-MG000 - White, RAL 9010

Spares & Fixings Accessories see pages 90-95



EFDC Range 122



Stopping Plugs 174



GUV Range 120



Ex e Cable Gland 164

Related Products



Part No. B019T

XEL-BAES Range

Self-contained emergency lighting fitting



Approvals / Characteristics

Polycarbonate Version

 Glass Version

Features

- Manufactured from marine grade aluminium
- Supplied with offshore grade paint
- All components mounted on the gear tray for easy installation and maintenance
- Self contained luminaires with built in automatic facility to give local indication of result, test or control monitoring
- Available in polycarbonate (light, high impact resistant) or in glass (specific chemical environment & paint shop)
- Battery duration 2 hours
- Including accessories (cable gland & fixing brackets)

Certification & Standards

Approved to: EN60079-0, 60079-1, 60079-7, 60079-31, 60598-2-22
 EC TYPE Examination Certificate:
 Models SI & AI Models A & AK
 INERIS II ATEX 0052X INERIS II ATEX 0051X
 Ex II 2 G Ex II 2 G
 Ex de IIC T6 Gb Ex d IIC T6 Gb
 Ex II 2 D Ex II 2 D
 Ex tb IIIC T80°C IP66 Db Ex tb IIIC T80°C IP66 Db
Glow wire test: 960°C EN60598-2-22
Safe operating temperature range: -20°C to +55°C



The fixture is supplied with non-barrier cable glands. For installations in either Zone 1 or in the presence of Group IIC gases, barrier glands are required. Please refer to EN-60079-14

Ex Emergency lighting - XEL-BAES Range

Dimensions

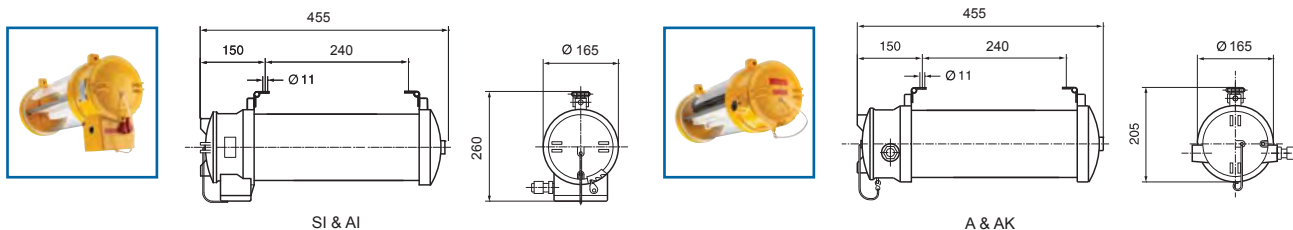

Technical Specifications

Type	Function	Rating (W)	Diffuser	Testing Type			Switch Type (see diagrams)			Weight (kg)
				Manual	Automatic	Addressable	Unswitched	Switch Off	Combined	
XEL3001-00000	Large area	1 x 8	Polycarbonate	●	-	-	●	-	-	5
XEL3002-00000*	Large area	2 x 8	Polycarbonate	●	-	-	●	-	-	5
XEL80A-00000	Escape route	1 x 6	Polycarbonate	-	●	-	●	-	-	4.7
XEL80AK-00000	Escape route	1 x 6	Polycarbonate	-	●	-	-	●	-	4.7
XEL80AI-00000	Escape route	1 x 6	Polycarbonate	-	●	-	-	-	●	5.5
XEL80SI-00000	Escape route	1 x 6	Polycarbonate	-	-	●	-	-	●	5.5
XEL300A-00000	Large area	1 x 8	Polycarbonate	-	●	-	●	-	-	5
XEL300AK-00000	Large area	1 x 8	Polycarbonate	-	●	-	-	●	-	5
XEL300AI-00000	Large area	1 x 8	Polycarbonate	-	●	-	-	-	●	5.5
XEL300SI-00000	Large area	1 x 8	Polycarbonate	-	-	●	-	-	●	5.5
XEL3001V-00000	Large area	1 x 8	Glass	●	-	-	●	-	-	7
XEL3002V-00000*	Large area	2 x 8	Glass	●	-	-	●	-	-	7
XEL80VA-00000	Escape route	1 x 6	Glass	-	●	-	●	-	-	6.5
XEL80VAK-00000	Escape route	1 x 6	Glass	-	●	-	-	●	-	6.5
XEL80VAI-00000	Escape route	1 x 6	Glass	-	●	-	-	-	●	7.3
XEL80VSI-00000	Escape route	1 x 6	Glass	-	-	●	-	-	●	7.3
XEL300VA-00000	Large area	1 x 8	Glass	-	●	-	●	-	-	7
XEL300VAK-00000	Large area	1 x 8	Glass	-	●	-	-	●	-	7
XEL300VAI-00000	Large area	1 x 8	Glass	-	●	-	-	-	●	7.5
XEL300VSI-00000	Large area	1 x 8	Glass	-	-	●	-	-	●	7.5

*Light always on

Enclosure

End caps and cover in marine grade aluminium alloy type AS10GY30. Yellow offshore polyurethane paint RAL 1003
UV protected extruded polycarbonate tube, thickness 2.5mm
Borosilicate glass, thickness 7mm

Rated voltages and emergency function

Electronic ballast: AC/DC 230V, 50Hz

Power factor

Up to 0.98

Cable entries

Model SI & AI: One M20 cable entry included
One cable gland (EXN04MMC2) - Nickel Plated Brass ISO M20 for non-armoured cable, diameter 10-16mm
Model A & AK: Two entries 3/4" NPT included
One 3/4" Nickel Plated Brass plug (EXN/075/SP)
One cable gland (EXN05AMC3) - 3/4" NPT Nickel Plated Brass for non-armoured cable, diameter 12-16mm

Self test SATI

Safety lighting with automatic built in systems test the lamps every 7 days and the battery pack every 12 weeks. Results of the test are displayed by yellow and green diodes.

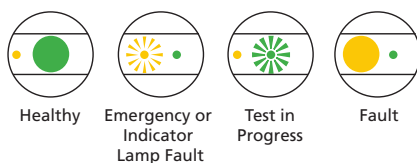

Battery

XEL80: Lumen output for 1 hour = 70lm, XEL300: Lumen output for 1 hour = 280lm
Model XEL 3001 and XEL 3002 - 3 hour models available for markets outside of France and are not NFC approved

Terminal block

Terminals supplied for L, N, PE
Model A & AK: Up to 10mm² (rigid wire), 6mm² (flexible wire)
Terminals supplied for L, N, PE (looping possible with additional cable glands)

Lamps (supplied installed)

XEL 80: emergency lamp: 1 x 6W tube with G5 lampholder (70 lumen), 2 charge lamp using LEDs

XEL 300: emergency lamp: 1 x 8W tube with G5 lampholder (280 lumen), 2 charge lamp using LEDs

Fixing

Standard: D023 - 2 Zinc Plated Steel articulated brackets for ceiling mounting

Colour (standard)

● XEL***-00000 - Yellow offshore, RAL 1003

Colour options

- XEL***-B0000 - Grey, RAL 7035
- XEL***-C0000 - Black, RAL 9004
- XEL***-D0000 - Hammered Blue, RAL 5015
- XEL***-F0000 - Red, RAL 3001
- XEL***-G0000 - Blue, RAL 5010
- XEL***-J0000 - Green, RAL 6032
- XEL***-M0000 - White, RAL 9010

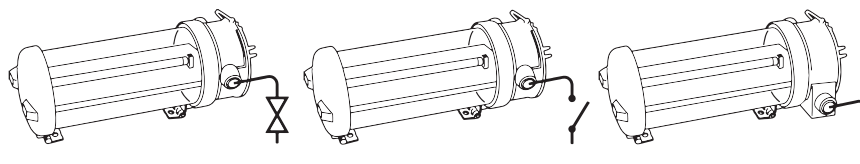

UNSWITCHED enclosure

Compulsory power socket
Fitting has to be removed
Maintenance must be done in safe area

Enclosure with battery SWITCH OFF

No power socket
External cut-out required
Maintenance done in hazardous area

Enclosure with COMBINED battery and supply switch off

No power socket
No external cut-out
Maintenance done in hazardous area



XEL-BAES Range Remote control units for emergency lighting

Provided by our
sister company

KAUFEL



Regulations

Article EC 12 paragraph 6

Self-contained emergency lighting installations must possess one or several devices allowing centralised control. The devices must be located close to the master control unit or one sub-division control units.

Technical Specifications

Type	Power Supply	Main Feature	Testing Type	Size (mm)
BT5F 621500	230V - 50-60Hz	Multi-brand compatibility ON / OFF offset	Unswitched - Switch off - combined	82 x 70 x 70
BT12V 621201	230V - 50-60Hz	Standard ON / OFF	Unswitched - Switch off - combined	82 x 70 x 70

Standard Remote Control installation (BAES)

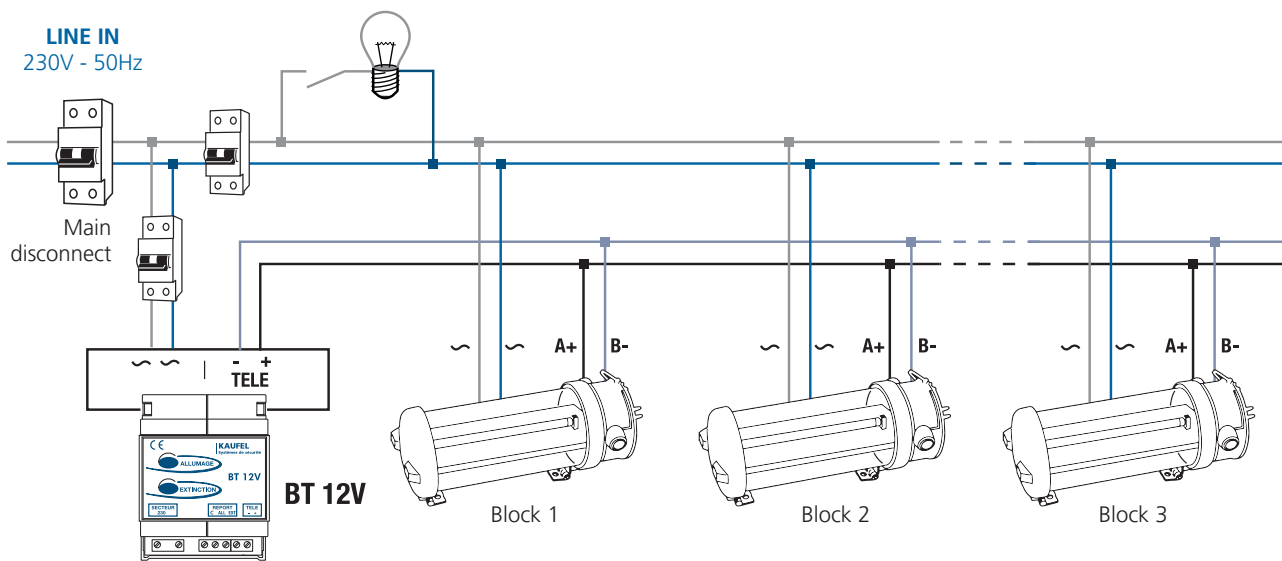

Remote Control installation with integrated self testing capabilities (SATI)

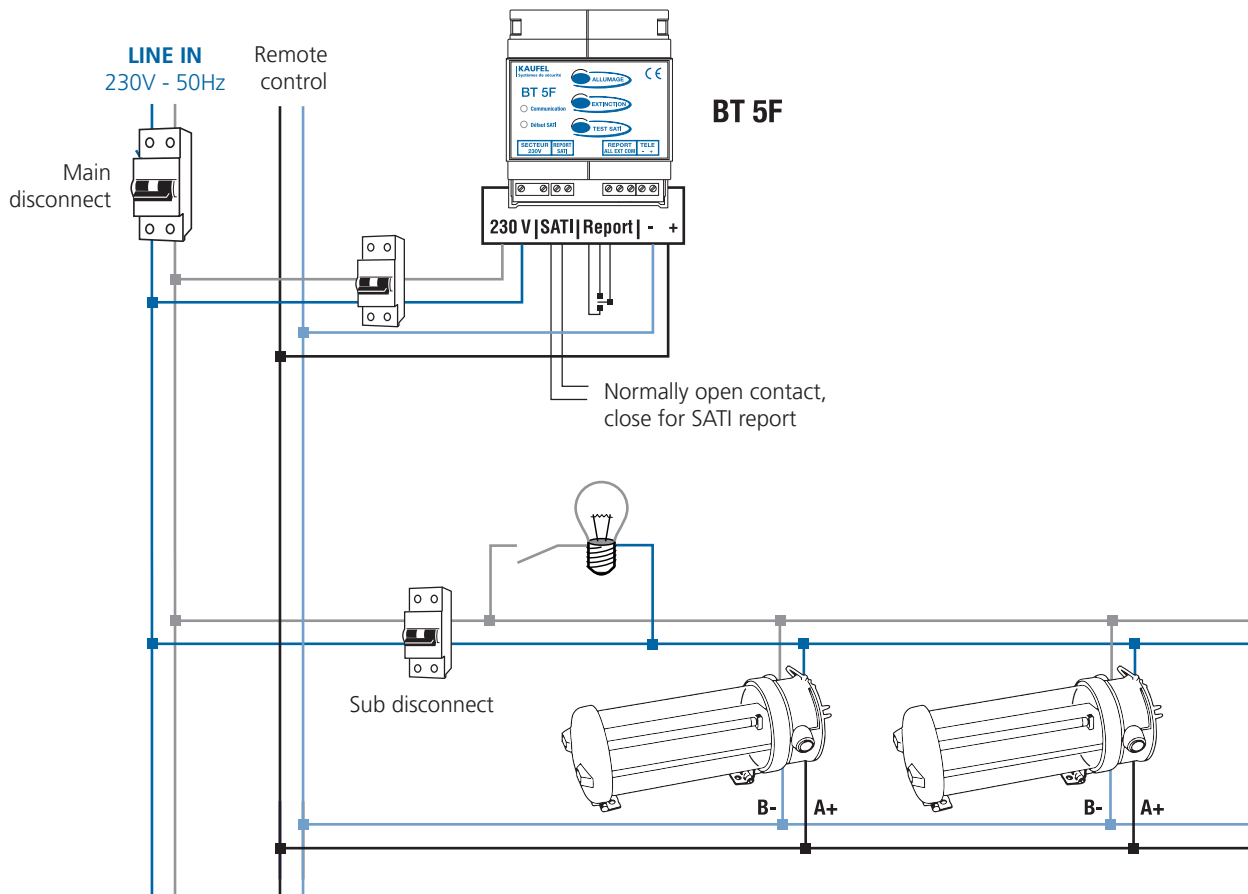



EVS-EM Range

Emergency fluorescent fitting with easy disconnect



Approvals / Characteristics

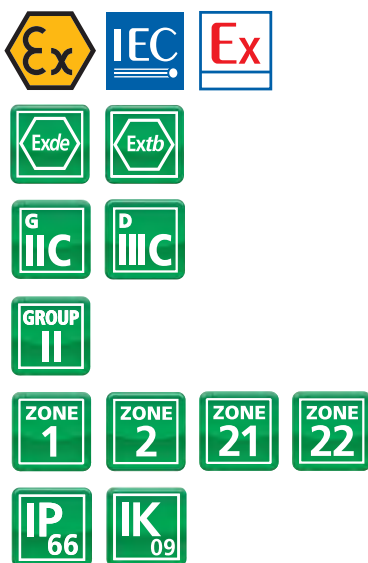

Features

- Easy disconnecter for safer maintenance out of zones
- Double central locking for ingress protection
- Main body constructed of a GRP for high impact strength
- Battery duration 2 hours
- All components mounted on hinged and removable gear tray which gives easy access for installation and maintenance
- Automatic switch off on opening for safe maintenance
- Including accessories (cable gland & fixing brackets)

Certification & Standards

Approved to: EN60079-0, 60079-1, 60079-5, 60079-7, EN61241-1
 EC TYPE Examination Certificate:
 LCIE 11 ATEX 3065X
 IEC Ex LCI 11.0053X
 Ex II 2 G
 Ex de IIC T4 Gb for $\leq -40^{\circ}\text{C}$ to $\leq +60^{\circ}\text{C}$
 Ex de IIC T5 Gb for $\leq -40^{\circ}\text{C}$ to $\leq +35^{\circ}\text{C}$
 Ex II 2 D
 Ex tb IIIC T85°C Db IP6X
 Glow wire test: 960°C EN60598-2-22
 Safe operating temperature range: -10°C to $+40^{\circ}\text{C}$
 IP test: IP66 IEC 60529 (2001)

Ex Emergency lighting - EVS-EM Range

Dimensions

Technical Specifications

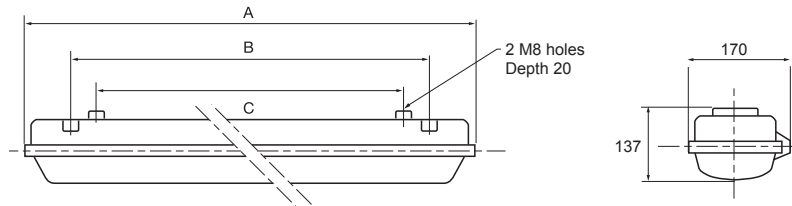

Type	Wiring		Battery	Nominal Current (A)	Dimensions (mm)			Weight (kg)
	Configuration	Rating (W)			A	B	C	
EVS120EME-0000*	3 Wire	1 x 18	2h	0.09	785	432	400	7.5
EVS120EME-C000*	3 Wire & Continuity plate	1 x 18	2h	0.09	785	432	400	7.5
EVS140EM-0000	3 Wire	1 x 36	2h	0.17	1370	900	700	9.5
EVS140EM-C000	3 Wire & Continuity plate	1 x 36	2h	0.17	1370	900	700	9.5
EVS220EME-0000*	3 Wire	2 x 18	2h	0.17	785	432	400	8.5
EVS220EME-C000*	3 Wire & Continuity plate	2 x 18	2h	0.17	785	432	400	8.5
EVS240EM-0000	3 Wire	2 x 36	2h	0.33	1370	900	700	10.5
EVS240EM-C000	3 Wire & Continuity plate	2 x 36	2h	0.33	1370	900	700	10.5

*Easy disconnect not available

Enclosure

Fiberglass reinforced polyester body
Polycarbonate diffuser, treated against UV
Standard: V015 - 2 Zinc Plated Steel brackets for ceiling mounting

For wiring, please refer to the instruction manual (drawings)

Technical assistance on request

Rated voltages

Standard: electronic ballast
AC/DC 220-240V, 50-60Hz
For other voltages contact Sales

Battery

Ni-Cd 7.2V 4Ah battery in flameproof case
Auto cut out of defective light
Lumen output in emergency mode (1 tube lit):
40% at 18W, 33% at 36W
Battery duration: 18W = 2 hours, 36W = 2hours
Monitored by one LED
Operating in maintained mode (when the main supply is connected: the tubes are lit, the battery charges / when the main supply is off: the emergency tube is lit and the battery does not recharge), or in non-maintained mode (when the main supply is connected: the tubes are not lit, the battery charges / when the main supply is off: the emergency tube is lit and the battery does not recharge)

Power factor

Up to 0.98

Cable entries

Standard: Three M20 cable entries included
Two M20 Nylon plugs (EX-M20)
One cable gland (EXCGM20S) - M20 Nylon for non-armoured cable, diameter 6-12mm
For armoured cable - continuity plate option: Nickel Plated Brass cable gland (EXN04MMC1), diameter 6-12 / 8.5-16mm (1 or 2 according to number of plates)

Terminal block

Up to 4mm² (rigid wire), 2.5mm² (flexible wire)
Select function: Lighting in maintained mode or lighting in non-maintained mode
Supplied L1, N, PE, 1, 2 Terminals

Lamps (order separately)

Tube G13 bi-pin T8 Ø 26 coolwhite 4000°k

Spares & Fixings Accessories see pages 90-95



EXB Conduit 138



Nylon Stopping Plugs 176



XB100 Range 104



Exe Nylon Gland 168

Related Products



EVS-EMA Range

Emergency fluorescent fitting with automatic test, and “BlackStart” capabilities



Approvals / Characteristics

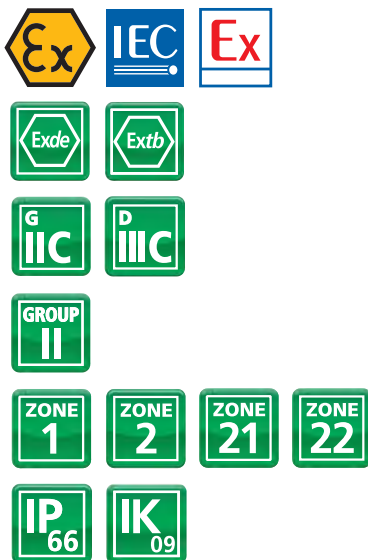

Features

- Double central locking for ingress protection
- Main body constructed of a GRP for high impact strength
- Polycarbonate diffuser to resist harsh and corrosive environments
- All components mounted on hinged and removable gear tray
- Battery duration 3 hours
- Automatic testing for preventive maintenance
- Clear LED for visual inspection
- Automatic switch off on opening for safe maintenance
- Possibility using the emergency inhibit mode
- Including accessories (cable gland & fixing brackets)

Certification & Standards

Approved to: EN60079-0, 60079-1, 60079-5, 60079-7, EN60079-31
 EC TYPE Examination Certificate:
 LCIE 11 ATEX 3065X
 IEC Ex LCI 11.0053X
 Ex II 2 G
 Ex de IIC T4 Gb for $\leq -40^{\circ}\text{C}$ to $\leq +60^{\circ}\text{C}$
 Ex de IIC T5 Gb for $\leq -40^{\circ}\text{C}$ to $\leq +35^{\circ}\text{C}$
 Ex II 2 D
 Ex tb IIC T85°C Db IP6X
 Glow wire test: 960°C EN605988-2-22
 Safe operating temperature range: -10°C to $+40^{\circ}\text{C}$
 IP test: IP66 IEC 60529 (2001)

Ex Emergency lighting - EVS-EMA Range

Dimensions

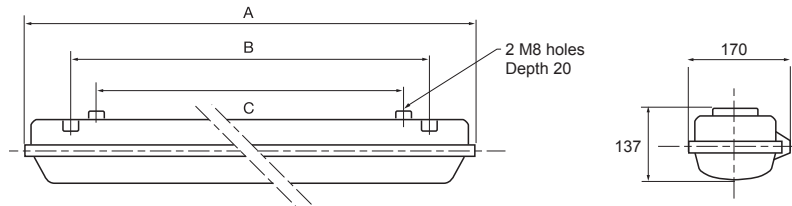

Technical Specifications

Type*	Wiring Configuration	Rating (W)	Battery	Nominal Current (A)	Dimensions (mm)			Weight (kg)
					A	B	C	
EVS120EMA-0000	3 / 5 Wire Loop	1 x 18	3h	0.09	785	432	400	7.5
EVS120EMA-D000	3 / 5 Wire & Continuity plate	1 x 18	3h	0.09	785	432	400	7.5
EVS140EMA-0000	3 / 5 Wire Loop	1 x 36	3h	0.17	1370	900	700	9.5
EVS140EMA-D000	3 / 5 Wire & Continuity plate	1 x 36	3h	0.17	1370	900	700	9.5
EVS220EMA-0000	3 / 5 Wire Loop	2 x 18	3h	0.17	785	432	400	8.5
EVS220EMA-D000	3 / 5 Wire & Continuity plate	2 x 18	3h	0.17	785	432	400	8.5
EVS240EMA-0000	3 / 5 Wire Loop	2 x 36	3h	0.33	1370	900	700	10.5
EVS240EMA-D000	3 / 5 Wire & Continuity plate	2 x 36	3h	0.33	1370	900	700	10.5

*Note: terminal blocks accept either 3 or 5 wire configurations (see instruction manual)

Enclosure

Fiberglass reinforced polyester body
Polycarbonate diffuser, treated against UV

Cable entries

Standard: Three M20 cable entries included
Two M20 Nylon plugs (EX-M20)
One cable gland (EXCGM20S) - ISO M20 Nylon for non-armoured cable, diameter 6-12mm
For armoured cable - continuity plate option: Nickel Plated Steel cable gland (EXN04MMC1), diameter 6-12 / 8.5-16mm (1 or 2 according to number of plates)

Fixing

Standard: V015 - 2 Zinc Plated Steel brackets for ceiling mounting

Rated voltages

Standard: electronic ballast
AC/DC 220-240V, 50-60Hz
For other voltages contact Sales

Power factor

Up to 0.98

For wiring please refer to the instruction manual (drawings)

Downloads available at tnb-hazardous.com

Battery

Ni-Cd 6V 4Ah for 18W /
Ni-Cd 6V 7Ah for 36W battery in flameproof case
Auto cut out of defective light
Lumen output in emergency mode (1 tube lit): 40% at 18W, 33% at 36W
Battery duration: 3h max 36W
Operating in maintained mode (when the main supply is connected: the tubes are lit, the battery charges / when the main supply is off: the emergency tube is lit and the battery does not recharge), or in non-maintained mode (when the main supply is connected: the tubes are not lit, the battery charges / when the main supply is off: the emergency tube is lit and the battery does not recharge)

BlackStart

It is possible to wire the EVS-EMA in order to open the fixture in ATEX zones in a completely powered down mode (battery disconnected)
Normal mode: If main power is off, battery powers emergency tube, main tubes are not lit
Disabled mode (terminals B S not connected, usually via switch): Power off, battery is disconnected, and neither main, nor emergency tubes are lit

Preventive maintenance - Self test

- Battery charge - daily
 - Emergency lamp during 1min - weekly
 - Battery charge capacity during 1hr - quarterly
 - Clear system test display
- Battery charge monitored by 2 LED

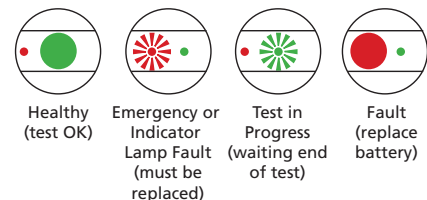

Terminal block

Up to 4mm² (rigid wire), 2.5mm² (flexible wire)
Terminals supplied L1, L2, L3, LS, N, PE

Lamps

Command must be supplied with switch on line
Tube G13 bi-pin T8 Ø 26 coolwhite 4000°K

Spares & Fixings Accessories see pages 90-95



EXB Conduit 138



Nylon Stopping Plugs 176



XB100 Range 104



Exe Nylon Gland 168

Related Products



EVN-EM Range Emergency fluorescent fitting



Approvals / Characteristics



Features

- Double central locking for ingress protection
- Main body constructed of a GRP for high impact strength
- Battery duration 2 hours
- All components mounted on hinged and removable gear tray which gives easy access for maintenance
- Including accessories (cable gland & fixing brackets)
- Option: automatic switch off on opening

Certification & Standards

Approved to: EN60079-0, 60079-15
 EC TYPE Examination Certificate:
 Ex II 3 G
 Ex nR IIC T4 Gb for $\leq -40^{\circ}\text{C}$ to $\leq +60^{\circ}\text{C}$
 Ex nR IIC T6 Gb for $\leq -40^{\circ}\text{C}$ to $\leq +35^{\circ}\text{C}$
 Ex II 3 D
 Ex tc IIC T85°C Dc IP6X
 Glow wire test: 960°C EN60598-2-22
 Safe operating temperature range: -10°C to $+40^{\circ}\text{C}$
 IP test: IP66 IEC 60529 (2001)

Ex Emergency lighting - EVN-EM Range

Dimensions

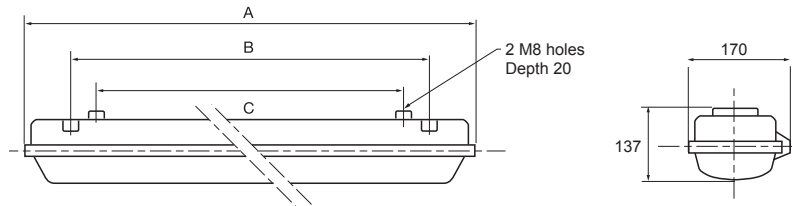

Technical Specifications

Type	Wiring Configuration	Rating (W)	Battery	Nominal Current (A)	Dimensions (mm)			Weight (kg)
					A	B	C	
EVN120EM-0000	5 Wire Loop	1 x 18	2h	0.09	785	432	400	6.5
EVN120EM-D000	5 Wire Loop & Continuity plate	1 x 18	2h	0.09	785	432	400	6.5
EVN140EM-0000	5 Wire Loop	1 x 36	2h	0.17	1370	900	700	8.5
EVN140EM-D000	5 Wire Loop & Continuity plate	1 x 36	2h	0.17	1370	900	700	8.5
EVN220EM-0000	5 Wire Loop	2 x 18	2h	0.17	785	432	400	7.5
EVN220EM-D000	5 Wire Loop & Continuity plate	2 x 18	2h	0.17	785	432	400	7.5
EVN240EM-0000	5 Wire Loop	2 x 36	2h	0.33	1370	900	700	10.5
EVN240EM-D000	5 Wire Loop & Continuity plate	2 x 36	2h	0.33	1370	900	700	10.5

*EVN...EM-.0C0 Automatic switch off on opening (to complete with wiring configuration)

Enclosure

Fibreglass reinforced polyester body
Polycarbonate diffuser, treated against UV

Fixing

Standard: V015 - 2 Zinc Plated Steel brackets for ceiling mounting

For wiring, please refer to the instruction manual (drawings)

Technical assistance on request

Rated voltages

Standard: electronic ballast
AC/DC 220-220V, 50-60Hz

Battery

Ni-Cd 7.2V 4Ah battery
Lumen output in emergency mode (1 tube lit)
40% at 18W, 33% at 36W
Monitored by one LED:

- operating in maintained mode;
 - when the main supply is connected: the tubes are lit, the battery charges
 - when the main supply is off: the emergency tube is lit and the battery does not recharge
- Operating in non maintained mode;
 - when the main supply is connected: the tubes are not lit, the battery charges
 - when the main supply is off: the emergency tube is lit and the battery does not recharge

Power factor

Up to 0.98

Cable entries

Standard: Three M20 cable entries included
Two M20 Nylon plugs (EX-M20)
One cable gland (EXCGM20S) - ISO M20 Nylon for non-armoured cable, diameter 6-12mm
For armoured cable - continuity plate option: Nickel Plated Brass cable gland (EXN04MMC1), diameter 6-12 / 8.5-16mm

Terminal block

Up to 4mm² (rigid wire), 2.5mm² (flexible wire)
Select function: Lighting in maintained mode or lighting in non-maintained mode
Terminal block supplied: N, PE, L1, L2, L3, LS (Looping possible with additional cable gland)

Lamps (order separately)

Tube G13 bi-pin T8 Ø 26 coolwhite 4000°k

EMA version available upon request

(with automatic test) - similar to EVS-EMA

Spares & Fixings Accessories see pages 90-95



EXB Conduit 138



Nylon Stopping Plugs 176



XB100 Range 104



Exe Nylon Gland 168

Related Products



EVD-EM Range Emergency fluorescent fitting



Approvals / Characteristics

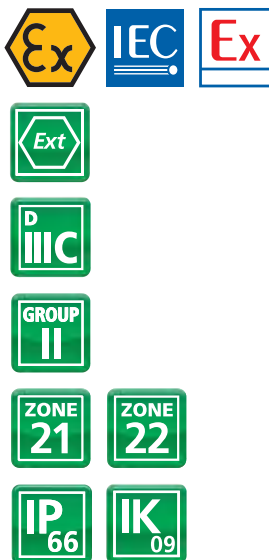

Features

- Double central locking for ingress protection
- Main body constructed of a GRP for high impact strength
- Polycarbonate diffuser to resist harsh and corrosive environments
- All components mounted on hinged and removable gear tray which gives easy access for installation and maintenance
- Battery duration 2 hours
- Including accessories (cable gland & fixing brackets)
- Option: automatic switch off on opening

Certification & Standards

Approved to: EN60079-0, 60079-31
 EC TYPE Examination Certificate: Under new 94/9/EC self certified
 LCIE II ATEX 3092X
 IECEx LCI 11.0064X
 Ex t IIIC T82°C (≤ +60°C) Db
 Ex t IIIC T62°C (≤ +40°C) Db
 Glow wire test: 960°C EN60598-2-22
 Safe operating temperature range: -10°C to +40°C
 IP test: IP66 IEC 60529 (2001)

Ex Emergency lighting - EVD-EM Range

Dimensions

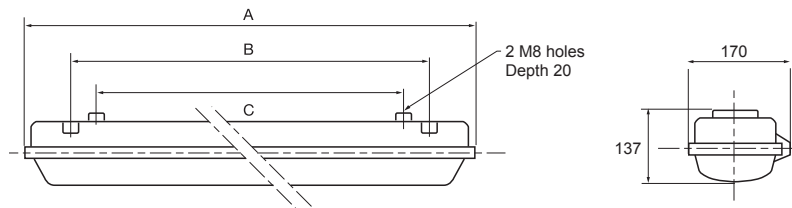

Technical Specifications

Type	Wiring		Battery	Nominal Current (A)	Dimensions (mm)			Weight (kg)
	Configuration	Rating (W)			A	B	C	
EVD120EM-00J0	5 Wire Loop	1 x 18	2h	0.09	785	432	400	6.5
EVD120EM-D0J0	5 Wire Loop & Continuity plate	1 x 18	2h	0.09	785	432	400	6.5
EVD140EM-00J0	5 Wire Loop	1 x 36	2h	0.17	1370	900	700	8.5
EVD140EM-D0J0	5 Wire Loop & Continuity plate	1 x 36	2h	0.17	1370	900	700	8.5
EVD220EM-00J0	5 Wire Loop	2 x 18	2h	0.17	785	432	400	7.5
EVD220EM-D0J0	5 Wire Loop & Continuity plate	2 x 18	2h	0.17	785	432	400	7.5
EVD240EM-00J0	5 Wire Loop	2 x 36	2h	0.33	1370	900	700	10.5
EVD240EM-D0J0	5 Wire Loop & Continuity plate	2 x 36	2h	0.33	1370	900	700	10.5

*EVD...EM-.0C0 Automatic switch off on opening (to complete with wiring configuration)

Enclosure

Fiberglass reinforced polyester body
Polycarbonate diffuser, treated against UV

Fixing

Standard: V015 - 2 Zinc Plated Steel brackets for ceiling mounting

For wiring, please refer to the instruction manual (drawings)

Technical assistance on request

Rated voltages

Standard: dual tube electronic ballast
AC/DC 220-240V, 50-60Hz

Battery

Ni-Cd 7.2V 4Ah
Lumen level in emergency mode (1 tube lit):
40% at 18W, 33% at 36W
Battery duration in emergency mode: 2 hours
Battery charge monitored by one LED
Operating in maintained mode (when the main supply is connected: the tubes are lit, the battery charges / when the main supply is off: the emergency tube is lit and the battery does not recharge), or in non-maintained mode (when the main supply is connected: the tubes are not lit, the battery charges / when the main supply is off: the emergency tube is lit and the battery does not recharge)

Power factor

Up to 0.98

Cable entries

Standard: Three M20 cable entries included
Two M20 Nylon plugs (EX-M20)
One cable gland (EXCGM20S) - M20 Nylon for non-armoured cable, diameter 6-12mm
For armoured cable - continuity plate option: Nickel Plated Brass cable gland (EXN04MMC1), diameter 6-12 / 8.5-16mm

Terminal block

Up to 4mm² (rigid wire), 2.5mm² (flexible wire)
Terminals supplied for N, PE, L1, L2, L3, LS
Select function: Lighting in maintained mode or lighting in non-maintained mode

Lamps (order separately)

Tube G13 bi-pin T8 Ø 26 coolwhite 4000°K

EMA version available upon request

(with automatic test) - similar to EVS-EMA

Spares & Fixings Accessories see pages 90-95



EXB Conduit 138



Nylon Stopping Plugs 176



XB100 Range 104



Exe Nylon Gland 168

Related Products



ESB-EM Range

Recessed emergency fluorescent fitting

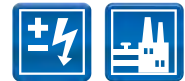

Approvals / Characteristics



Features

- Main body made from powder coated steel
- 6mm toughened glass making it perfect for laboratories
- Automatic switch off upon opening for safe maintenance
- Battery duration 2 hours
- Including accessories (cable gland)

Certification & Standards

Approved to: EN60079-0, 60079-1, 60079-7
 EC TYPE Examination Certificate: Under 94/9/EC
 INERIS II ATEX 0058X
 Ex II 2 G
 Ex de IIC T4 Gb for $\leq -40^{\circ}\text{C}$ to $\leq +60^{\circ}\text{C}$
 Glow wire test: 850°C EN60598-2-22
 Safe operating temperature range: -10°C to $+40^{\circ}\text{C}$
 IP test: IP66 IEC 60529 (2001)

Ex Emergency lighting - ESB-EM Range

Dimensions

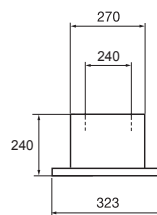
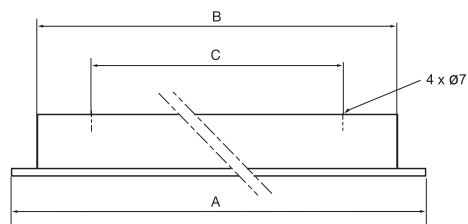

Technical Specifications

Type	Wiring		Battery	Nominal Current (A)	Glass	Dimensions (mm)			Weight (kg)
	Configuration	Rating (W)				A	B	C	
ESB240EM-0000	5 Wire Loop	2 x 36	2h	0.33	Toughened	1364	1312	105	22
ESB240EM-A000	5 Wire Loop	2 x 36	2h	0.33	Frosted	1364	1312	105	22

Enclosure

Steel housing and body painted in white polyester powderpaint RAL 9016
6mm clear toughened glass panel (optional frosted low lumen output)
Neoprene gasket

For wiring, please refer to the instruction manual (drawings)

Technical assistance on request

Rated voltages

Standard: electronic ballast:
AC/DC 220-240V, 50-60Hz

Battery

Ni-Cd 7.2V 4Ah battery in flameproof case
Lumen level in emergency mode (1 tube lit): 33%
Emergency load duration: 2 hours
Battery change monitored by LED
Operating in maintained mode (when the main supply is connected: the tubes are lit, the battery charges / when the main supply is off: the emergency tube is lit and the battery does not recharge), or in non-maintained mode (when the main supply is connected: the tubes are not lit, the battery charges / when the main supply is off: the emergency tube is lit and the battery does not recharge)

Power factor

Up to 0.98

Cable entries

Standard: Two M20 cable entries included
One M20 Nylon plug (EX-M20)
One cable gland (EXCGM20S) - M20 Nylon for non-armoured cable, diameter 6-12mm

Terminal block

Up to 4mm² (rigid wire), 2.5mm² (flexible wire)
Terminals supplied N, PE, L1, 1, 2
Select function: Lighting in maintained mode or lighting in non-maintained mode
Lamps (order separately)
Tube G13 bi-pin T8 Ø 26 coolwhite 4000°k

Fixing

Fixing by 4 M6 threaded bolts (not supplied) joined to the main body

Spares & Fixings Accessories see pages 90-95



EXB Conduit 138



Nylon Stopping Plugs 176



XB100 Range 104



Exe Nylon Gland 168

Related Products

Industrial Lighting - Non-Hazardous locations



Industrial Lighting - Non-Hazardous Locations





FF Range

Weatherproof tubular fluorescent fitting



Approvals / Characteristics



Features

- Ingress protection IP66 ideal for wash down areas
- All components mounted on a removable gear tray which gives easy access for installation and maintenance
- Tubular shape to avoid waste accumulation
- Including accessories (cable gland & fixing brackets)

Technical Data

Glow wire test: 960°C EN60598-2-22
Safe operating temperature range: -20°C to +50°C
IP test: IP66 IEC 60529 (2001)

Dimensions

Technical Specifications

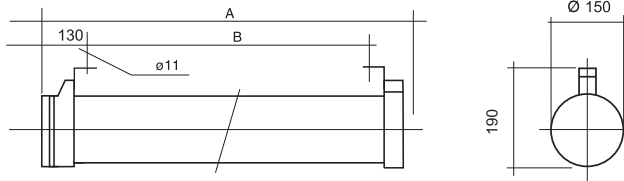

Type	Wiring Configuration	Diffuser	Nominal Rating (W)	Current (A)	Dimensions (mm)		Weight (kg)
					A	B	
FR120-0G000	5 Wire	Polycarbonate	1 x 18	0.15	780	565	4
FR136-0G000	5 Wire	Polycarbonate	2 x PL36	0.2	780	565	4.5
FR140-0G000	5 Wire	Polycarbonate	1 x 36	0.2	1385	1170	7
FR155-0G000	5 Wire	Polycarbonate	1 x PL55	0.35	780	565	4.5
FR165-0G000	5 Wire	Polycarbonate	1 x 58	0.35	1690	1475	8
FF220-0G000	5 Wire	Polycarbonate	2 x 18	0.3	780	565	4.5
FF236-0G000	5 Wire	Polycarbonate	2 x PL36	0.4	780	565	5
FF240-0G000	5 Wire	Polycarbonate	2 x 36	0.4	1385	1170	7
FF255-0G000	5 Wire	Polycarbonate	2 x PL55	0.7	780	565	5
FF265-0G000	5 Wire	Polycarbonate	2 x 58	0.7	1690	1475	9

Enclosure

Reinforced black polycarbonate end caps
UV protected extruded polycarbonate tube, thickness 2.5mm

Temperature

Ambient temperature: -20°C to +50°C

Fixing

Standard: D023 - 2 Zinc Plated Steel articulated brackets for ceiling mounting

Rated voltages

Electronic ballast: AC/DC 110-260V, 50-60Hz

Power factor

Up to 0.98

Cable entries

Standard: Two M20 entries included

One plug (EX-M20)

One cable gland (EXCGM20S) - M20 Nylon for non-armoured cable, diameter 6-12mm

Terminal block (plug in terminal block)

Up to 10mm² (rigid wire), 6mm² (flexible wire)

Standard: terminals supplied for L1, L2, L3, N, PE

Looping possible with additional cable gland

Lamps (order separately)

T8 bi-pin G13 tube, Ø 26 - white industry 4000°K

G11 compact fluorescent PL lamp

Spares & Fixings Accessories see pages 90-95



EXB Conduit 138



Nylon Stopping Plugs 176



XB100 Range 104



Exe Nylon Gland 168

Related Products



EL Range

Weatherproof miniature tubular fluorescent fitting



Approvals / Characteristics



Features

- Small and compact for confined spaces
- Ingress protection IP66 ideal for wash down areas
- All components mounted on a removable gear tray which gives easy access for installation and maintenance
- Tubular shape to avoid waste accumulation
- Including accessories (cable gland & fixing brackets)

Technical Data

Glow wire test: 960°C EN60598-2-22

Safe operating temperature range: -20°C to +50°C

IP test: IP66 IEC 60529 (2001)

Dimensions

Technical Specifications

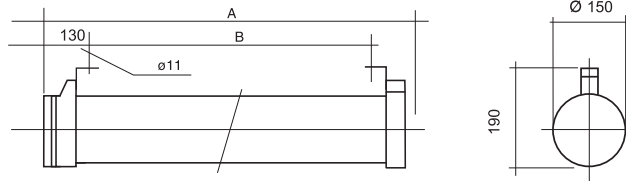

Type	Wiring Configuration	Diffuser	Nominal Rating (W)	Current (A)	Dimensions (mm)		Weight (kg)
					A	B	
EL3008-0G000	5 Wire	Polycarbonate	1 x 8	0.1	455	240	3
EL3009-0G000	5 Wire	Polycarbonate	1 x PL9	0.1	455	240	3
EL30011-0G000	5 Wire	Polycarbonate	1 x PL11	0.1	455	240	3.5
EL120-0G000	5 Wire	Polycarbonate	1 x PL18	0.3	455	240	3.5
EL220-0G000	5 Wire	Polycarbonate	2 x PL18	0.5	455	240	4
EL30028-0G000	5 Wire	Polycarbonate	2 x 8	0.1	455	240	3.5

Enclosure

Reinforced black polycarbonate end caps
LEXAN 2034 UV protected extruded polycarbonate tube, thickness 2.5mm
Neoprene gasket

Temperature

Ambient temperature: -20°C to +50°C

Fixing

Standard: D023 - 2 Zinc Plated Steel articulated brackets for ceiling mounting

Rated voltages

Standard:
Electronic ballast: AC/DC 220-240V, 50/60Hz

Power factor

Up to 0.98

Cable entries

Standard: Two M20 entries included
One plug (EX-M20)
One cable gland (EXCGM20S) - M20 Nylon for non-armoured cable, diameter 6-12mm

Terminal block (plug in terminal block)

Up to 10mm² (rigid wire), 6mm² (flexible wire)
Standard terminals supplied for L1, L2, L3, N, PE
Looping possible with additional cable glands

Lamps (order separately)

T8 bi-pin G13 tube, Ø 26 - white industry 4000°K
G11 compact fluorescent PL lamp
Lamp with G11 base (18W)
or G23 (7W, 9W, 11W)

Spares & Fixings Accessories see pages 90-95



EXB Conduit 138



Nylon Stopping Plugs 176



XB100 Range 104



Exe Nylon Gland 168

Related Products



SF / QF / EF Range Weatherproof floodlight fitting



Approvals / Characteristics



Features

- Compact, lightweight and robust ideal for lighting large areas
- Integral junction box: rapid installation
- Excellent photometric properties, wide or narrow beam
- Including accessories (cable gland & lamps installed)
- Supplied with offshore grade paint

Technical Data

IP test: IP66 IEC 60529 (2001)

Dimensions

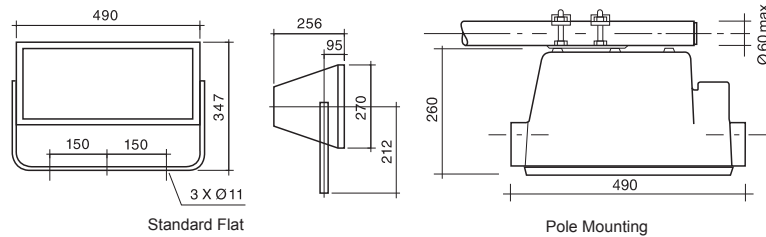

Technical Specifications

Type*	Nominal Rating (W)	Current (A)	Mounting	Weight (kg)
SF70P-00000	1 x 70 HP Sodium	0.4	Flat	17
SF70G-00000	1 x 70 HP Sodium	0.4	Pole	17
SF150P-00000	1 x 150 HP Sodium	0.8	Flat	17
SF150G-00000	1 x 150 HP Sodium	0.8	Pole	17
SF250P-00000	1 x 250 HP Sodium	1.3	Flat	18
SF250G-00000	1 x 250 HP Sodium	1.3	Pole	18
SF400P-00000	1 x 400 HP Sodium	2.1	Flat	20
SF400G-00000	1 x 400 HP Sodium	2.1	Pole	20
QF250P-00000	1 x 250 Metal Halide	1.3	Flat	18
QF250G-00000	1 x 250 Metal Halide	1.3	Pole	18
QF400P-00000	1 x 400 Metal Halide	2.1	Flat	20
QF400G-00000	1 x 400 Metal Halide	2.1	Pole	20
EF110P-00000	2 x 55 Halogen 12V	9.2	Flat	13
EF110G-00000	2 x 55 Halogen 12V	9.2	Pole	13
EF140P-00000	2 x 70 Halogen 24V	5.8	Flat	13
EF140G-00000	2 x 70 Halogen 24V	5.8	Pole	13

*Option: ...F... -0A000 (to complete with nominal rating & mounting) - Narrow beam, for example: SF400P-0A000

Enclosure

Marine grade aluminium alloy type according to EN1706:EN AC-AISi7 Mg 0,6 T6
Cathoretically treated
12mm toughened glass
Stainless steel screws

Temperature

Ambient temperature: -20°C to +60°C

Rated voltages

Standard: 230V 50Hz ferromagnetic ballast, with capacitor
Option: 220V 60Hz ferromagnetic ballast or 120V 60Hz on few models, ferromagnetic ballast

Power factor

Up to 0.85 for version with compensated ballast (Sodium HP and metal halide)

Cable entries

Standard: Two M20 entries included
One M20 Nickel Plated Brass plug (EXN/M20/SP)
One cable gland (EXN04MMC2) - Nickel Plated Brass M20 for non-armoured cable, diameter 10-16mm

Lamps (Installed)

Polished aluminium reflector
Standard: wide beam
Option: narrow beam

Other options

Sling (SC100 ELINGUE)
Galvanised steel support with base plate (SA103)
Pre wired masthead floodlighting systems: Full system with 2 or 4 floodlights (to complete with nominal rating), for example HM 4400 (4 x 400 W HPS)
(See photo on XF Range)

Terminal block

Up to 6mm² (rigid wire), 4mm² (flexible wire)
Terminals supplied: L, N, PE

Fixing

Standard: galvanised steel flat mounting bracket,
Pole mounted: Ø 40 to 60mm

Colour (standard)

● SF/QF/EF***-00000 - Yellow offshore, RAL 1003

Colour options

- SF/QF/EF***-B0000 - Grey, RAL 7035
- SF/QF/EF***-C0000 - Black, RAL 9004
- SF/QF/EF***-D0000 - Hammered Blue, RAL 5015
- SF/QF/EF***-F0000 - Red, RAL 3001
- SF/QF/EF***-G0000 - Blue, RAL 5010
- SF/QF/EF***-J0000 - Green, RAL 6032
- SF/QF/EF***-M0000 - White, RAL 9010

Spares & Fixings Accessories see pages 90-95



EXB Conduit 138



Stopping Plugs 174



XB100 Range 104



Ex e Cable Gland 166

Related Products



EVT Range

Weatherproof fluorescent fitting with diffuser

Approvals / Characteristics



Features

- Double central locking for ingress protection
- Including accessories (cable gland & fixing brackets)
- Option: automatic switch off on opening

Technical Data

Glow wire test: 960°C EN60598-2-22

Safe operating temperature range: -20°C to +50°C

IP test: IP66 IEC 60529 (2001)

Dimensions

Technical Specifications

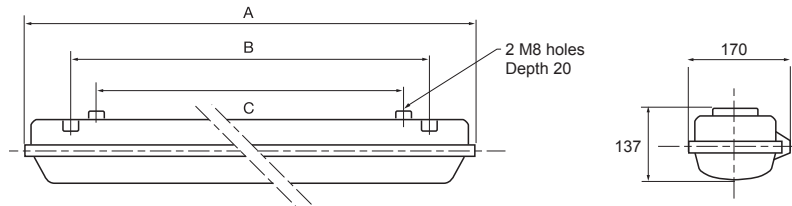

Type*	Wiring Configuration	Rating (W)	Nominal Current (A)	Dimensions (mm)			Weight (kg)
				A	B	C	
EVT120-A0J0	5 Wire Loop	1 x 18	0.09	785	432	400	4.2
EVT120-D0J0	5 Wire Loop & Continuity plate	1 x 18	0.09	785	432	400	4.2
EVT140-A0J0	5 Wire Loop	1 x 36	0.17	1370	900	700	6.5
EVT140-D0J0	5 Wire Loop & Continuity plate	1 x 36	0.17	1370	900	700	6.5
EVT165-A0J0	5 Wire Loop	1 x 58	0.26	1670	900	700	8
EVT165-D0J0	5 Wire Loop & Continuity plate	1 x 58	0.26	1670	900	700	8
EVT220-A0J0	5 Wire Loop	2 x 18	0.17	785	432	400	4.5
EVT220-D0J0	5 Wire Loop & Continuity plate	2 x 18	0.17	785	432	400	4.5
EVT240-A0J0	5 Wire Loop	2 x 36	0.33	1370	900	700	6
EVT240-D0J0	5 Wire Loop & Continuity plate	2 x 36	0.33	1370	900	700	6
EVT265-A0J0	5 Wire Loop	2 x 58	0.5	1670	900	700	8.5
EVT265-D0J0	5 Wire Loop & Continuity plate	2 x 58	0.5	1670	900	700	8.5

**(Through options) Define type rating (to complete with rating): EVT...-B0J0 5 Wires through, EVT...-E0J0 with two continuity plates, EVT...-0C0 Automatic switch off on opening (to complete with wire configuration)*

Enclosure

Fiberglass reinforced polyester body
Polycarbonate diffuser, treated against UV

Temperature

Ambient temperature: -20°C to +50°C

Fixing

Standard: V015 - 2 Zinc Plated Steel brackets for ceiling mounting

Rated voltages

Standard electronic ballast:
AC/DC 110-260V, 50-60Hz

Power factor

Up to 0.98

Cable entries

Standard: Three M20 cable entries included
Two M20 Nylon plug (EX-M20)
One cable gland (EXCGM20S) - M20 Nylon for non-armoured cable, diameter 6-12mm
For armoured cable - continuity plate option:
Nickel Plated Brass cable gland (EXN04MMC1), diameter 6-12 / 8.5-16mm (1 or 2 according to number of plates)

Terminal block

Up to 6mm² (rigid wire), 4mm² (flexible wire)
Standard: Terminals supplied for L1, L2, L3, N, PE
Looping possible with additional cable glands
5 wire through option I MAX =16A max

Lamps (order separately)

T8 bi-pin G13 tube, Ø 26 - cool white 4000°K

Spares & Fixings Accessories see pages 90-95



EXB Conduit 138



Nylon Stopping Plugs 176



XB100 Range 104



Exe Nylon Gland 168

Related Products



EST Range

Weatherproof recessed fluorescent fitting

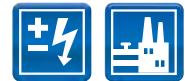

Approvals / Characteristics



Features

- Fitting combines photometric qualities, strength and design
- Including accessories (cable gland)

Technical Data

Glow wire test: 960°C EN60598-2-22
Safe operating temperature range: -20°C to +50°C
IP test: IP64 IEC 60529 (2001)

Dimensions

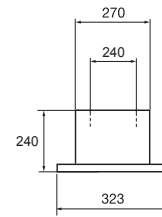
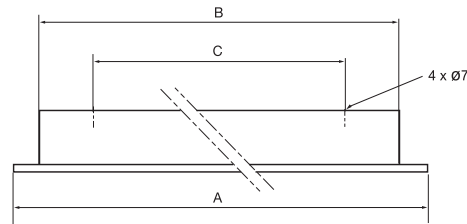

Technical Specifications

Type	Wiring Configuration	Rating (W)	Glass	Nominal Current (A)	Dimensions (mm)			Weight (kg)
					A	B	C	
EST220-00J0	5 Wire Loop	2 x 18	Toughened	0.17	753	702	105	12.5
EST220-A0J0	5 Wire Loop	2 x 18	Frosted	0.17	753	702	105	12.5
EST240-00J0	5 Wire Loop	2 x 36	Toughened	0.33	1364	1312	105	20
EST240-A0J0	5 Wire Loop	2 x 36	Frosted	0.33	1364	1312	105	20
EST265-00J0	5 Wire Loop	2 x 58	Toughened	0.5	1664	1612	105	25
EST265-A0J0	5 Wire Loop	2 x 58	Frosted	0.5	1664	1612	105	25

Enclosure

Steel housing and body painted in white polyester powder paint RAL 9016 (stainless steel 304L on request)

6mm clear toughened glass panel (optional frosted low lumen output)

Temperature

Operating temperature range: -20°C to +40°C

Rated voltages

Standard: electronic ballast
AC/DC 110-260V, 50-60Hz

Power factor

Up to 0.98

Cable entries

Standard: Two M20 cable entries included

One M20 Nylon plug (EX-M20)

One cable gland (EXCGM20S) - ISO M20 Nylon for non-armoured cable, diameter 6-12mm

Terminal block

Up to 4mm² (rigid wire), 2.5mm² (flexible wire)

Terminals supplied L1, L2, L3, N, PE

Lamps (order separately)

Tube G13 bi-pin T8 Ø 26 coolwhite 4000°k

Fixing

Fixing by 4 M6 threaded bolts (not supplied) joined to the main body

Spares & Fixings Accessories see pages 90-95



EXB Conduit 138



Nylon Stopping Plugs 176



XB100 Range 104



Exe Nylon Gland 168

Related Products



FB / FL Range

Weatherproof warning lights and beacons



Approvals / Characteristics



Features

- Lightweight and robust for easy installation
- Static or flashing versions available for use in a variety of applications
- Choice of 5 colours of globe
- 2 or 3 light versions available for traffic signals
- Including accessories (cable gland, plug & lamp installed)

Technical Data

IP test: IP66 IEC 60529 (2001)

Dimensions

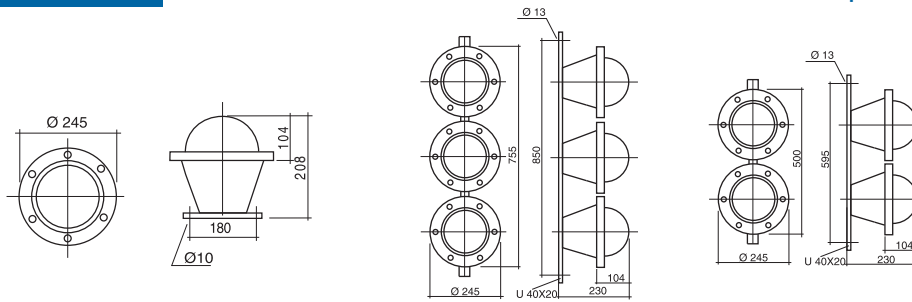

Contact Sales for Mounting Options

Technical Specifications

Type	Rating (W)	Lamp	Standard Globe*	Version	Rated Voltages	Weight (kg)
FB30-00000	1 x 28	E27	Red	Halogen	AC 230V 50/60Hz	3.5
FB70-00000	1 x 8	E27	Red	LED	AC 100-240V 50/60Hz	3.5
FL30P-00000	30 Joules	Picots	Red	Xenon flash	AC 230V 50/60Hz	4
FL30P-0C000	30 Joules	Picots	Red	Xenon flash	AC 100V 50/60Hz	4
FL30P-0D000	30 Joules	Picots	Red	Xenon flash	DC 24V	4
FL30P-0E000	30 Joules	Picots	Red	Xenon flash	DC 48V	4
FL30P-0F000	30 Joules	Picots	Red	Xenon flash	DC 110V	4

*Choice of globe colours: XF...-00000 - Red, XF...-000A0 - Transparent globe, XF...-000B0 - Green globe, XF...-000C0 - Orange globe, XF...-000D0 - Blue globe

**For colour combinations: Colour combination: please contact Sales for more information

Enclosure

Marine grade aluminium alloy type
EN1706 AC-43100KF-AISI 10Mg
Aluminium reflector

Temperature

Ambient temperature: -20°C to +60°C

Cable entries

Standard: Two entries M20 included
One M20 nickel plated brass plug (EXN/M20/SP) and
one cable gland (EXN04MMC2) - Nickel Plated Brass
ISO M20 for non-armoured cable, diameter 10-16mm

Terminal block

Up to 6mm²
Terminals supplied for L, N, PE

Lamps (supplied)

For xenon flash versions
Flashing rate: 45 to 60 - per minute

Globe

Polycarbonate, thickness 3mm

Colour (standard)

● FB/FL***-00000 - Yellow offshore, RAL 1003

Colour options

- FB/FL***-B0000 - Grey, RAL 7035
- FB/FL***-C0000 - Black, RAL 9004
- FB/FL***-D0000 - Hammered Blue, RAL 5015
- FB/FL***-F0000 - Red, RAL 3001
- FB/FL***-G0000 - Blue, RAL 5010
- FB/FL***-J0000 - Green, RAL 6032
- FB/FL***-M0000 - White, RAL 9010

Spares & Fixings Accessories see pages 90-95



EXB Conduit 138



Stopping Plugs 176



XB100 Range 104



Ex e Cable Gland 166

Related Products



HF Range Portable floodlight



Approvals / Characteristics



Features

- Lightweight and robust
- Free standing on base plate for stable use in high winds
- Fully portable with carrying handle
- Including accessories (cable gland & lamp installed)

Technical Data

IP test: IP66 IEC 60529 (2001)

Dimensions

Technical Specifications

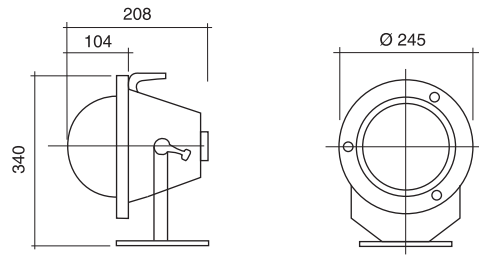

Type	Rating (W)	Lamp	Power Supply (V)	Nominal Current (A)	Weight (kg)
HF55P-00000	55	Halogen H3	12	4.6	6
HF70P-00000	70	Halogen H3	24	2.9	6

Enclosure

Marine grade aluminium alloy
Globe: 3mm thick transparent polycarbonate

Temperature

Ambient temperature: -20°C to +60°C

Cable entries

One M20 entry included
One cable gland (EXN04MMC2) - ISO M20 Nickel Plated Brass for non-armoured cable, diameter 10-16mm

Terminal block

Up to 6mm²
Terminals supplied L, N, PE

Lamps (supplied)

70W - 24V iodine lamp - H3 lampholder
55W - 12V iodine lamp - H3 lampholder

Fixing (including)

Galvanised steel support with base plate ref. SA103

Spares & Fixings Accessories see pages 90-95



EXL Conduit 148



Stopping Plugs 176



GUV Range 120



Ex e Cable Gland 166

Related Products



FR-EM / FF-EM Range

Emergency weatherproof tubular fluorescent fitting



Approvals / Characteristics



Features

- Ingress protection IP66 ideal for wash down areas
- All components mounted on removable gear tray which gives easy access for installation and maintenance
- Battery 2h duration
- Tubular shape to avoid waste accumulation
- Including accessories, cable gland & fixing brackets

Technical Data

Glow wire test: 960°C EN60598-2-22

Safe operating temperature range: -20°C to +40°C

Industrial Emergency Lighting - FR-EM / FF-EM Range

Dimensions

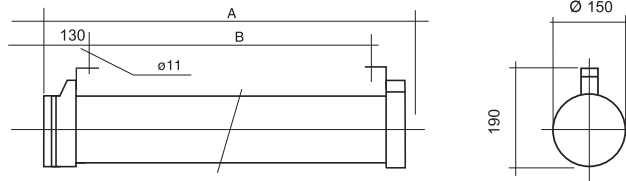

Technical Specifications

Type	Wiring Configuration	Diffuser	Rating (W)	Nominal Current (A)	Battery	Dimensions (mm)		Weight (kg)
						A	B	
FR120EM-0G000	3 Wire	Polycarbonate	1 x 18	0.15	2h	780	565	5
FR140EM-0G000	3 Wire	Polycarbonate	1 x 36	0.2	2h	1385	1170	8
FF220EM-0G000	3 Wire	Polycarbonate	2 x 18	0.2	2h	780	565	5.5
FF240EM-0G000	3 Wire	Polycarbonate	2 x 36	0.35	2h	1385	1170	8

Enclosure

Reinforced black polycarbonate end caps
UV protected extruded polycarbonate tube, thickness 2.5mm

Temperature

Ambient temperature: -10°C to +40°C

Fixing

Standard: D023 - 2 Zinc Plated Steel articulated brackets for ceiling mounting

For wiring, please refer to the instruction manual (drawings)

Technical assistance on request

Power Factor

Up to 0.98

Rated voltages

Electronic ballast: AC/DC 220-240V, 50-60Hz

Battery

Ni-Cd battery 7.2V, 4Ah

Lumen output in emergency mode (1 tube lit):
40% for 8W, 33% for 36W

Battery duration in emergency mode: 2 hours

Monitored by one LED

Operating in maintained mode (when the main supply is connected: the tubes are lit, the battery charges / when the main supply is off: the emergency tube is lit and the battery does not recharge), or in non-maintained mode (when the main supply is connected: the tubes are not lit, the battery charges / when the main supply is off: the emergency tube is lit and the battery does not recharge)

Cable entries

Standard: Two M20 entries included

One cable gland (EXCGM20S) - ISO M20 Nylon for non-armoured cable, diameter 6-12mm

One Nylon plug (EXM20)

Terminal block (plug in terminal block)

Terminals supplied: L1,2,N, PE

Up to 10mm² (rigid wire), 6mm² (flexible wire)

Standard: terminals supplied for L1, 2, N, PE

Looping possible with additional cable gland

Lamps (order separately)

T8 bi-pin G13 tube, Ø 26 - white industry 4000°K

Spares & Fixings Accessories see pages 90-95



EXB Conduit 138



Nylon Stopping Plugs 176



XB100 Range 104



Exe Nylon Gland 168

Related Products



EVT-EM Range

Emergency weatherproof fluorescent fitting with diffuser

Approvals / Characteristics



Features

- Double central locking for ingress protection
- Battery duration 2 hours
- Included accessories (cable gland & fixing brackets)
- Option: automatic switch off on opening

Technical Data

Glow wire test: 960°C EN60598-2-22
Safe operating temperature range: -10°C to +40°C
IP test: IP66 IEC 60529 (2001)

Industrial Emergency Lighting - EVT-EM Range

Dimensions

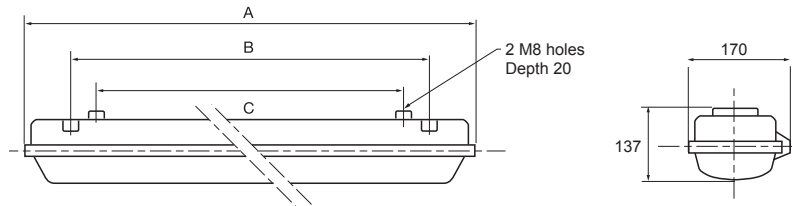

Technical Specifications

Type*	Wiring		Battery	Nominal Current (A)	Dimensions (mm)			Weight (kg)
	Configuration	Rating (W)			A	B	C	
EVT120EM-00J0	5 Wire	1 x 18	2h	0.09	785	432	400	6.5
EVT120EM-D0J0	5 Wire & Continuity plate	1 x 18	2h	0.09	785	432	400	6.5
EVT140EM-00J0	5 Wire	1 x 36	2h	0.17	1370	900	700	8.5
EVT140EM-D0J0	5 Wire & Continuity plate	1 x 36	2h	0.17	1370	900	700	8.5
EVT220EM-00J0	5 Wire	2 x 18	2h	0.17	785	432	400	7.5
EVT220EM-D0J0	5 Wire & Continuity plate	2 x 18	2h	0.17	785	432	400	7.5
EVT240EM-00J0	5 Wire	2 x 36	2h	0.33	1370	900	700	10.5
EVT240EM-D0J0	5 Wire & Continuity plate	2 x 36	2h	0.33	1370	900	700	10.5

*(Through options) EVT...-0C0 Automatic switch off on opening (to complete with wire configuration)

Enclosure

Fiberglass reinforced polyester body
Polycarbonate diffuser, treated against UV

Temperature

Ambient temperature: -10°C to +40°C

Fixing

Standard: V015 - 2 Zinc Plated Steel brackets for ceiling mounting

For wiring, please refer to the instruction manual (drawings)

Technical assistance on request

Rated voltages

Electronic ballast: AC/DC 220-240V, 50-60Hz

Battery

Ni-Cd 7.2V 4Ah

Lumen level in emergency mode (1 tube lit):

40% for 18W, 33% for 36W

Battery duration in emergency mode:

2 hours

Battery charge monitored by LED

Operating in maintained mode (when the main supply is connected: the tubes are lit, the battery charges / when the main supply is off: the emergency tube is lit and the battery does not recharge), or in non-maintained mode (when the main supply is connected: the tubes are not lit, the battery charges / when the main supply is off: the emergency tube is lit and the battery does not recharge)

Power factor

Up to 0.98 with electronic ballast

Cable entries

Standard: Three M20 cable entries included

Two M20 Nylon plugs (EX-M20)

One cable gland (EXCGM20S) - M20 Nylon for non-armoured cable, diameter 6-12mm

For armoured cable - continuity plate option:

Nickel Plated Brass cable gland (EXN04MMC1), diameter 6-12 / 8.5-16mm (1 or 2 according to number of plates)

Terminal block (plug in terminal block)

Up to 6mm² (rigid wire), 4mm² (flexible wire)

Terminals supplied : L1, L2, L3, N, PE, LS

Select function: Lighting in maintained mode or lighting in non-maintained mode

Lamps (order separately)

T8 bi-pin G13 tube, Ø 26 - cool white 4000°K

EMA version available upon request

(with automatic test) - similar to EVS-EMA

Spares & Fixings Accessories see pages 90-95



EXB Conduit 138



Ex d Cable Gland 162



XB100 Range 104



Exe Nylon Gland 168

Related Products



EST-EM Range

Emergency weatherproof recessed fluorescent fitting

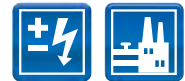

Approvals / Characteristics



Features

- Fitting combines photometric qualities, strength and design
- Battery duration 2 hours
- Included accessories (cable gland)

Technical Data

Glow wire test: 850°C EN60598-2-22
Safe operating temperature range: -10°C to +40°C
IP test: IP66 IEC 60529 (2001)

Industrial Emergency Lighting - EST-EM Range

Dimensions

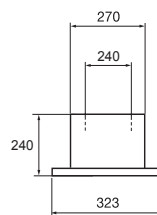
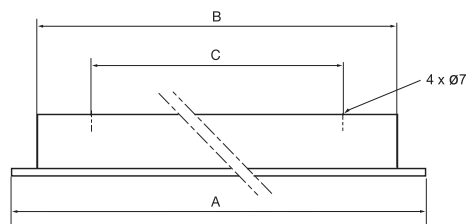

Technical Specifications

Type	Wiring		Rating (W)	Battery	Nominal Current (A)	Glass	Dimensions (mm)			Weight (kg)
	Configuration						A	B	C	
EST240EM-00J0	5 Wire		2 x 36	2h	0.33	Toughened	1364	1312	105	22
EST240EM-A0J0	5 Wire		2 x 36	2h	0.33	Frosted	1364	1312	105	22

Enclosure

Steel housing and body painted in white polyester powder paint RAL 9016
6mm clear toughened glass panel (optional frosted low lumen output)

Temperature

Operating temperature range:
-10°C to +40°C

For wiring, please refer to the instruction manual (drawings)

Technical assistance on request

Rated voltages

Electronic ballast:
Standard: AC/DC 220-240V, 50-60Hz

Battery

Ni-Cd 7.2V 4Ah
Lumen level in emergency mode (1 tube lit): 33%
Emergency load duration: 2 hours
Battery charge monitored by LED
Operating in maintained mode (when the main supply is connected: the tubes are lit, the battery charges / when the main supply is off: the emergency tube is lit and the battery does not recharge), or in non-maintained mode (when the main supply is connected: the tubes are not lit, the battery charges / when the main supply is off: the emergency tube is lit and the battery does not recharge)

Power factor

Up to 0.98

Cable entries

Standard: Two M20 cable entries included
One M20 Nylon plug and
One cable gland (EXCGM20S) - ISO M20 Nylon for non-armoured cable, diameter 6-12mm
One Nylon plug (EX-M20)

Terminal block

Up to 4mm² (rigid wire), 2.5mm² (flexible wire)
Terminals for L, N, PE terminal 1 and terminal 2
Select function: Lighting in maintained mode or lighting in non-maintained mode
Lamps (order separately)
Tube G13 bi-pin T8 Ø 26 coolwhite 4000°k

Spares & Fixings Accessories see pages 90-95



EXB Conduit 138



Nylon Stopping Plugs 176



XB100 Range 104



Exe Nylon Gland 168

Related Products

Fixing Accessories

Fixing Accessories for DTS lighting fittings

Fixing Accessories for EV Fluorescent Light Fitting Range

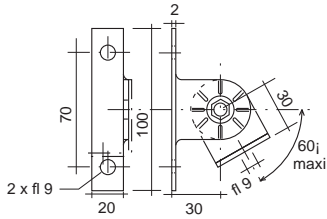

Hinged bracket
V023: plastic coated

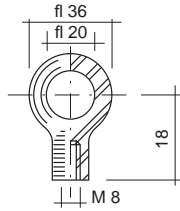

Hook
V024: zinc plated steel

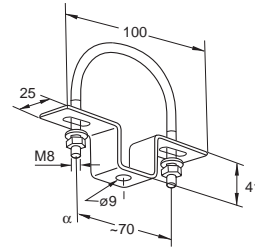

**Fixing bracket and flange for
ø 1"1/4 and 1"1/2**
V018: zinc plated steel (V019 - 2")
V021: stainless steel 316L (V022 - 2")

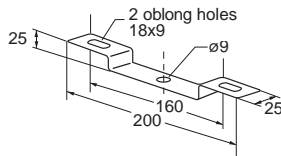

Brackets
Standard V015: zinc plated steel
V016: stainless steel 316L

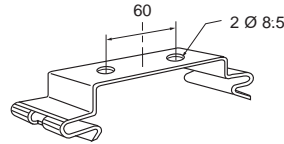

Mounting bracket clip
V014: stainless steel

Fixing Accessories for Tubular Fitting: XFF / XFR / XFP / XEL / XEP / XFF-EM / XFP-EM / FF / FR / EL / FF-EM Range

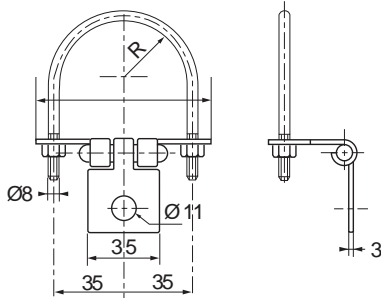

**U-bolt for pole mounting
for 1"1/4**
D025: zinc plated steel
(D026 - 1"1/2)
(D027 - 2")

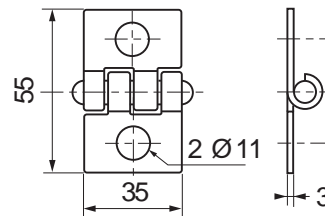

Bracket
Standard D023: zinc plated steel
D024: stainless steel 304L

Spare Parts

Spare Parts for DTS lighting fittings

Spare Parts for EVS / EVN / EVD / EVN / EVT Fluorescent Light Fitting Range

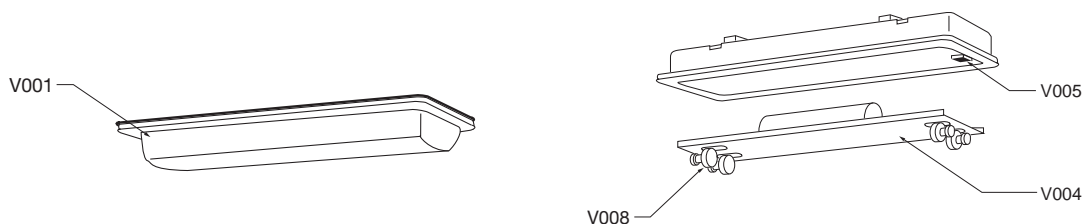

EVS-EM/EMA Range

Type	Specifications
V001	Transparent diffuser (included gasket)*
V004	Complete gear tray*
V005S	Connection Pack: Switch, Connector, Terminal
V008	Bi-pin Lampholder
V011	Battery pack*

EVN / EVD / EVT-EM/EMA Range

Type	Specifications
V001	Transparent diffuser (included gasket)*
V004	Complete gear tray*
V005E	Switch*
V008N	Bi-pin Lampholder

*Define type, rating and operating voltage

Spare Parts for ES Recessed Fluorescent Light Fitting Range

ESB / ESB-EM Range

Type	Specifications
Z001	Transparent frame*
Z007	Electronic Ballast*
V008	Lampholder
V011	Battery Pack*

EST / EST-EM Range

Type	Specifications
Z001	Transparent frame*
Z007N	Electronic Ballast*
V008N	Lampholder

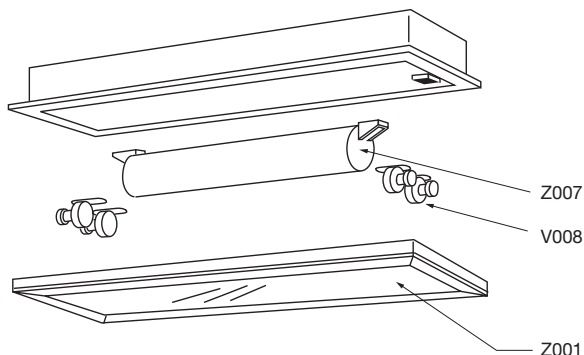

*Define type, rating and operating voltage

Spare Parts

Spare Parts for DTS lighting fittings

Spare Parts for XFF / XFR Tubular Light Fitting Range

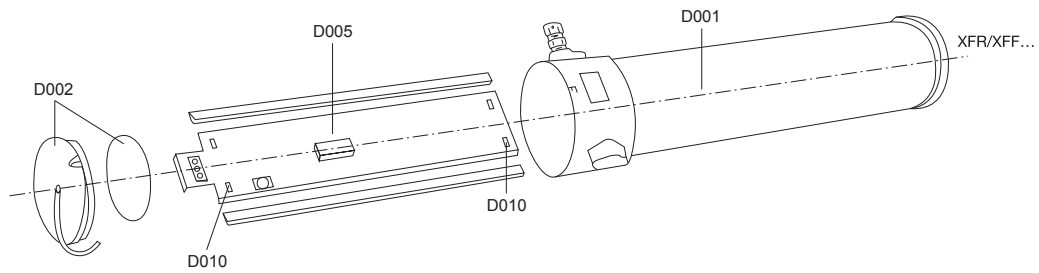

XFF / XFR Range

Type	Specifications
D001	Sealed tube, cover, gasket, chain and slides*
D002	Cover, chain, gasket
D005	Complete gear tray* (included FF/FR Range)
D010	Bi-pin Lampholder
4GRA00002S	Grease for tubular model

*Define type, rating and operating voltage

Spare Parts for XFP Tubular Light Fitting Range

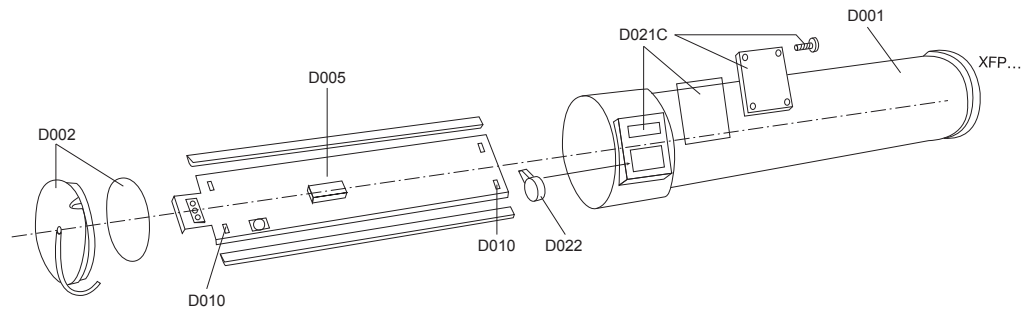

XFP Range

Type	Specifications
D001	Sealed tube, cover, gasket, chain and slides*
D002	Cover, chain, gasket
D005	Complete gear tray*
D010	Bi-pin Lampholder
D021C	Cover, gasket, screw, terminals, switch of junction boxes
D022	Interlock
4GRA00002S	Grease for tubular model

*Define type, rating and operating voltage

Spare Parts

Spare Parts for DTS lighting fittings

Spare Parts for XEL / XEP Miniature Tubular Light Fitting Range

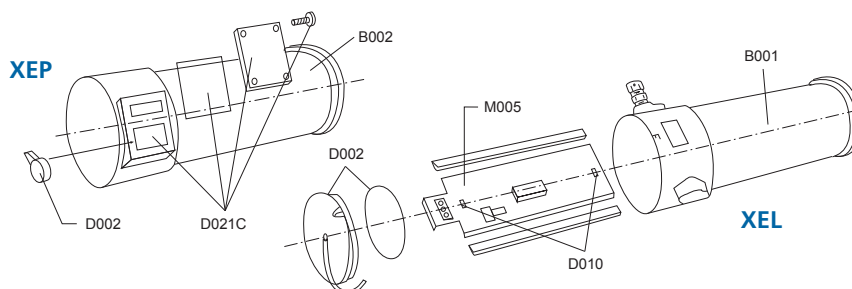

XEL Range

Type	Specifications
B001	Sealed tube, cover, gasket, chain and slides*
D002	Cover, chain, gasket
M005	Complete gear tray* (included EL Range)
D010	Bi-pin Lampholder*
4GRA00002S	Grease for tubular model

XEP Range

Type	Specifications
B002	Sealed tube, cover, gasket, chain and slides*
D002	Cover, chain, gasket
M005	Complete gear tray*
D010	Bi-pin Lampholder*
D021C	Cover, gasket, screw, terminals, switch and interlock of junction boxes
D022	Interlock
4GRA00002S	Grease for tubular model

*Define type, rating and operating voltage

Spare Parts for XSF / XQF / XEF / EF / SF / QF Floodlight Range

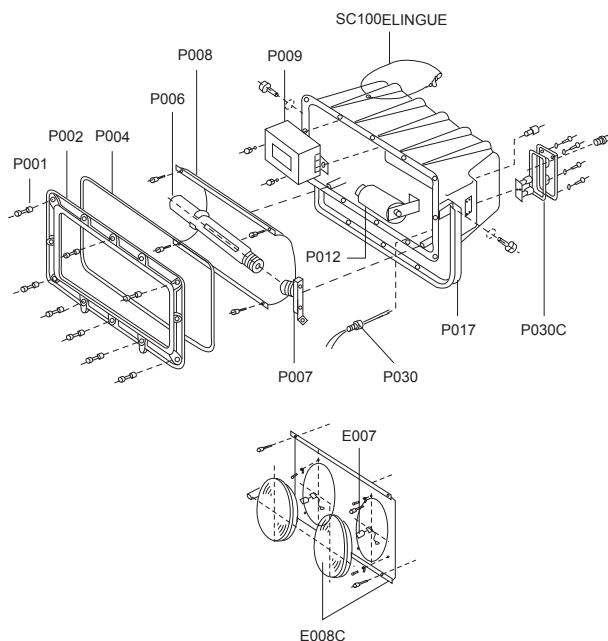

XSF / XQF / XEF / SF / QF / EF Range

Type	Specifications
P001	Closing Screw (12)
P002	Sealed front glass*
P004	Gasket*
P006	Lamp*
P007	Lampholder
P008	Reflector*
P009	Ferromagnetic Ballast*
P010	Ferromagnetic Ballast 120V 60Hz (400W)
P012	Ignitor
P017FC	Fixing (including screws)
P030C	Boxes Accessories: terminal 2* 6mm ² + earthing terminal, + cover gasket, + cover, screw
P030	Ex trough connector
E007	Iodine Lamp*
E008C	Gear tray support, + fixing for optic, + optic for XEF
4GRA00001S	Grease for model XSF, XQF, XEF

*Define type, rating and operating voltage

Spare Parts

Spare Parts for DTS lighting fittings

Spare Parts for XFF-EM / XFP-EM Tubular Light Fitting Range

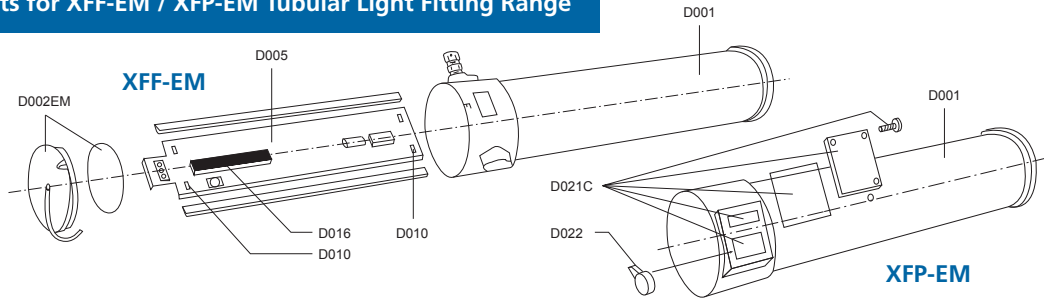

XFF-EM Range

Type	Specifications
D001	Sealed tube, cover, gasket, chain and slides*
D002EM	Cover, chain, gasket
D005	Complete gear tray*
D010	Bi-pin Lampholder
D016	Battery pack
4GRA00002S	Grease for tubular model

XFP-EM Range

Type	Specifications
D001	Sealed tube, cover, gasket, chain and slides*
D002EM	Cover, chain, gasket
D005	Complete gear tray*
D010	Bi-pin Lampholder
D016	Battery pack
D021C	Cover, gasket, screw, terminals, switch an interlock of junction boxes
D022	Interlock
4GRA00002S	Grease for tubular model

*Define type, rating and operating voltage

Spare Parts for XEL-BAES Range - XEL / XEP

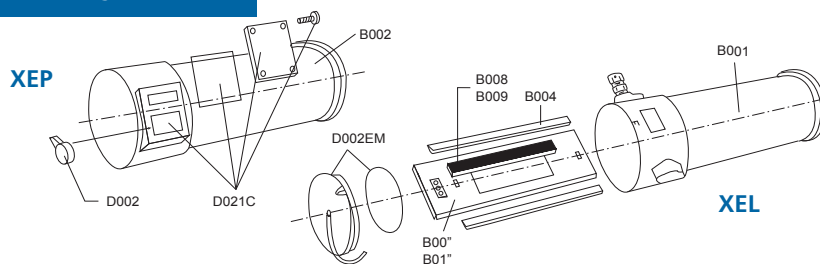

XEL- A / AK / AI / SI Range

Type	Specifications
B001	Sealed tube, cover, gasket, chain and slides*
D002EM	Cover, chain, gasket
B004	Slide for gear tray - XEL / XEP / XEL-BAES
B008B	Battery XEL 80A
B008C	Battery + XIN05 XEL80AK / XEL80AI / XEL80SI
B009A	Battery + XIN05 XEL300AK / XEL300AI / XEL300SI
B009	Battery XEL3001 / XEL300A
B005B	Gear tray - 230V 50Hz - XEL 80A
B006L	Gear tray - 230V 50/60Hz - XEL 3001
B007	Gear tray - 230V 50/60Hz - XEL 3002

B010B	Gear tray - 230V 50Hz - XEL 80AK / XEL80AI
B013K	Gear tray - 230V 50Hz - XEL 300AK / XEL300AI
B013	Gear tray - 230V 50Hz - XEL 300A
B014B	Gear tray - 230V 50Hz - XEL 80SI
B015	Gear tray - 230V 50Hz - XEL 300SI
4GRA00002S	Grease for tubular model

XEL - AI / SI Range (ONLY)

Type	Specifications
B002	Sealed tube, cover, gasket, chain and slides*
D021C	Cover, gasket, screw, terminals, switch and interlock of junction boxes
D022	Interlock

*Define type, rating and operating voltage

Spare Parts

Spare Parts for DTS lighting fittings

Spare Parts for XFB / XFL / FB / FL Beacons Range

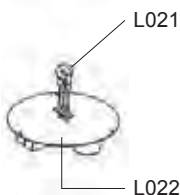
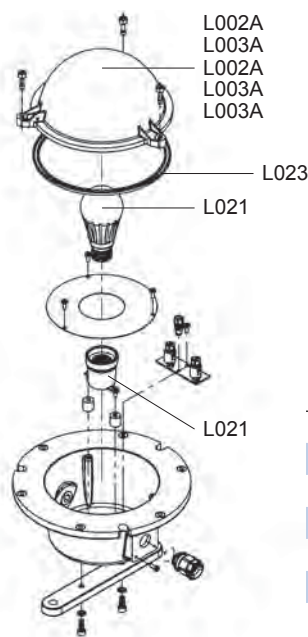

XFB / FB Range

Type	Specifications
L00*	Globe (included gasket L023)
L021	Lamp*
L013	Lampholder

XFL / FL Range

Type	Specifications
L00*	Globe (included gasket L023)
L021	Lamp*
L022110VCC	Gear tray - 110V DC - for XFL30P / XFL230P / XFL330P / FL30P / FL230P / FL330P
L022110VAC	Gear tray - 110V AC - for XFL30P / XFL230P / XFL330P / FL30P / FL230P / FL330P
L022220VAC	Gear tray - 220 - 230VAC 50-60Hz - for XFL30P / XFL230P / XFL330P / FL30P / FL230P / FL330P
L02224VCC	Gear tray - 24V DC - for XFL30P / XFL230P / XFL330P / FL30P / FL230P / FL330P
L02248VCC	Gear tray - 48V DC - for XFL30P / XFL230P / XFL330P / FL30P / FL230P / FL330P

*Define type, rating and operating voltage

Spare Parts for XDF Range

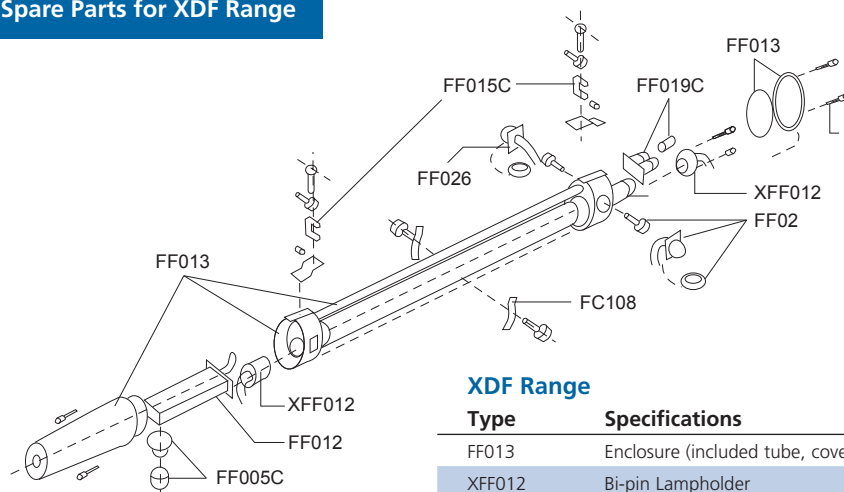

XDF Range

Type	Specifications
FF013	Enclosure (included tube, cover, gasket, screws)*
XFF012	Bi-pin Lampholder
FF005C	Lampholder and starter
FF012	Ferromagnetic ballast*
FF023D	Plug (2P + E) - 10Amp - 250V AC
FF024D	Socket (2P + E) - 10Amp - 250V AC
FF019C	Connecting and earthing terminals
FF015C	Beam clamp with screws and steel brackets
FF026	Extendable cable with socket and plug - (helical cable) expandable to 5 metre max

*Define type, rating and operating voltage

Lamps Guide

Guide to Lamps for use in DTS lighting fittings

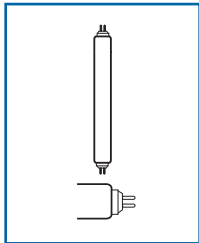

Bi-pin T8/T12 fluorescent tubes

Specifications:

G13 - ø 26mm or ø 38mm

CRI: > 80 - Lm/W: 65 > 93

Colour temperature:

2700K > 6500K

Average life: 6,000 > 10,000 hours

Standard or electronic ballast

Type	Power (W)	Flux (lm)	Cap
TL18W	18	1250	G13
TL36W	36	3350	G13
TL58W	58	5200	G13

Lighting equipment	Reference
Fluorescent	EVS...
Fluorescent	XFR / XFF / XFP...
Fluorescent	EVN...
Fluorescent	EVD...
Weatherproof fluorescent	EVT... FR/FF

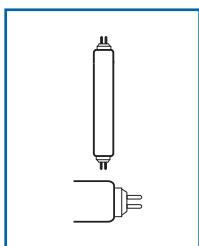

Miniature T5 fluorescent tubes

Specifications:

G5 - ø 15mm

CRI: 60 > 85 - Lm/W: 51 > 59

Colour temperature:

2700K > 4100K

Average life: 6,000 hours

Electronic ballast or inverter

Type	Power (W)	Flux (lm)	Cap
TL8W	8	430	G5

Lighting equipment	Reference
Miniature	XEL / XEP...
Weatherproof miniature	EL...
BAES range	XEL BAES...

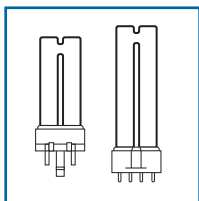

Compact fluorescent lamps

Specifications:

G23 or G11

CRI: 85 > 90 - Lm/W: 57 > 87

Colour temperature:

2700K > 4000K

Average life: 20,000 hours

Standard or electronic ballast, inverter

Type	Power (W)	Flux (lm)	Cap
PL7W	7	400	G23
PL9W	9	600	G23
PL11W	11	900	G23
PL18W	18	1200	2 G11
PL36W	36	2900	2 G11
PL55W	55	4800	2 G11

Lighting equipment	Reference
Miniature	XEL / XEP...
Weatherproof miniature	EL...
Fluorescent	XFR / XFF / XFP

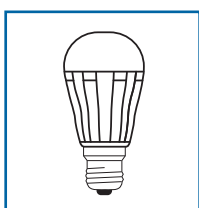

LED lamps

Specifications:

E27

CRI: 80 - Lm/W: 55

Colour temperature: 3000K

Average life: 25,000 hours

Integral electronic ballast

For lamp type - Contact Sales

Power (W)	Flux (lm)	Cap
8	345	E27

Lighting equipment	Reference
Beacon	XFB
Weatherproof beacon	FB

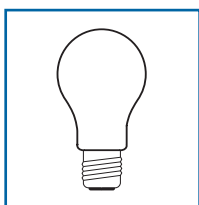

Halogen lamps

Specifications:

CRI: 100 - Lm/W: 10 > 17

Colour temperature:

2700K

Average life: 1,000 hours

For lamp type - Contact Sales

Power (W)	Flux (lm)	Cap
28	345	E27
70	1200	E27
140	3000	E27

Lighting equipment	Reference
Beacon	XFB
Wellglass	EVX / EVH
Weatherproof beacon	FB

Guide to Lamps for use in DTS lighting fittings

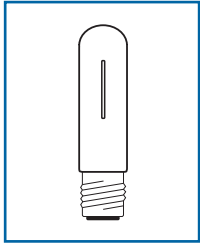

High pressure sodium tubular lamps

Specifications:

CRI: NS - Lm/W: 100 > 120
 Colour temperature: 2100K
 Average life: 15,000 > 20,000 hours
 Minimum starting temperature: -30°C
 Time to full power: 1 > 10mm
 With control gear and ignitor

Type	Power (W)	Flux (lm)	Cap
E007	70	6000	E40
P006150SHP	150	15000	E40
P006250SHP	250	28000	E40
P006400SHP	400	48000	E40

Lighting equipment Reference

Ex d floodlight XSF...
 Weatherproof floodlight SF...

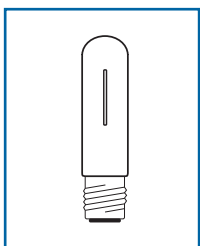

Metal halide tubular lamps

Specifications:

CRI: 65 - Lm/W: 68 > 76
 Colour temperature:
 4300K > 4600K
 Average life: 3,000 > 6,000 hours
 Minimum starting temperature: -25°C
 Time to full power: 5 > 10mm
 With control gear and ignitor

Type	Power (W)	Flux (lm)	Cap
P006250IM	250	20000	E40
P006400IM	400	42000	E40

Lighting equipment Reference

Ex d floodlight XQF...
 Weatherproof floodlight QF...

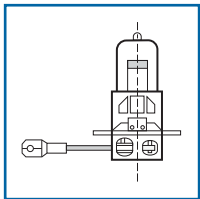

Halogen lamps

Specifications:

H3
 CRI: 100 - Lm/W: 25
 Colour temperature:
 3000K
 Average life: 1,000 hours

Type	Power (W)	Flux (lm)	Cap
S00755W	55	1350	H3
S00770W	70	1770	H3

Lighting equipment Reference

Ex d floodlight XEF / XHF...
 Weatherproof floodlight EF / HF...

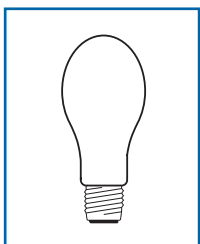

Metal halide elliptical lamps

Specifications:

CRI: 33 > 49 - Lm/W: 50 > 60
 Colour temperature:
 3900K > 4300K
 Average life: 15,000 > 20,000 hours
 Minimum starting temperature: -25°C
 Time to full power: 5 > 10mm
 With control gear
 For lamp type - Contact Sales

Power (W)	Flux (lm)	Cap
250	12700	E40
400	22000	E40

Lighting equipment Reference

Ex d wellglass EVX

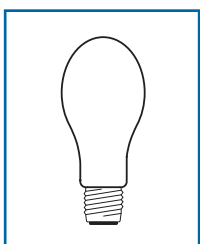

High pressure sodium elliptical lamps

Specifications:

CRI: NS - Lm/W: 80 > 125
 Colour temperature:
 2000K > 2200K
 Average life:
 34,000 hours
 Minimum starting temperature: -25°C
 Time to full power: 1 > 10mm
 With control gear and ignitor
 For lamp type - Contact Sales

Power (W)	Flux (lm)	Cap
70	6300	E27
150	17000	E40
250	31100	E40
400	55500	E40

Lighting equipment Reference

Ex d wellglass EVX / EVH Na...

Wellglass

EV Range

EVX / EVH Range

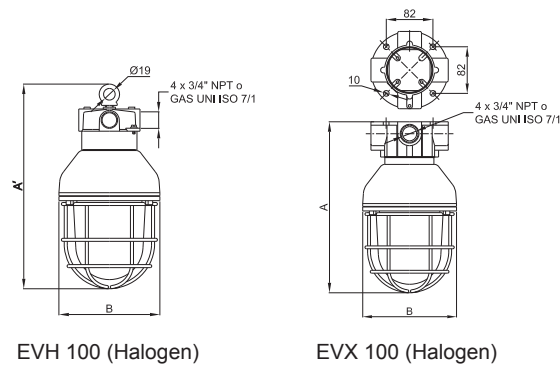

EVX Range - Halogen

Type	Rating (W)	Lamps	Nominal (A)	A/A'	B	T° Class	Weight in (kg)
EVX100-00000	70	E27 Halogen	0.45	250/283	150	T4	2.9
EVX200-00000	140	E27 Halogen	0.90	313/346	170	T3	3.5
EVX300-00000	250	E27 Mixed light	1.30	410/463	220	T3	7.2

*Suspension ring mounted version, remove X and add the H, e.g. EVH100-00000

EC TYPE Examination Certificate:

IECEX CES 07.0004
 CESI 12 ATEX 006
 GOST R
 II 2 GD
 Ex d IIC T...°C Gb
 Ex tb IIIC T...°C Db IP66

Enclosure

Body in marine grade aluminium alloy
 (CU<0.05%) Yellow polyurethane paint RAL1003
 Borosilicate glass globe
 Galvanised steel protection grill
 Ingress rating: IP65 (EN60529), neoprene ingress gasket
 Stainless steel screws

Temperature

Ambient temperature range:-20°C to +60°C
 Surface temperature classification: T4 to T3 (gas)

Power factor

Up to 0.85 (HP Sodium and metal halide)

Cable entries

EVH: four 3/4" NPT entries - fitted 2 plugs
 EVX: four 3/4" NPT entries - fitted 2 plugs

Terminal block

Up to 6mm² (rigid wire), 4mm² (flexible wire)

Lamps

Not supplied (order separately)

Fixing

Ceiling screw M8 (EVX)
 Suspension ring (EVH)
 Spare part: 30° angle wall mounting arm (R018)

EV Range

EVXNa / EVXIm / EVHNa / EVHIm Range

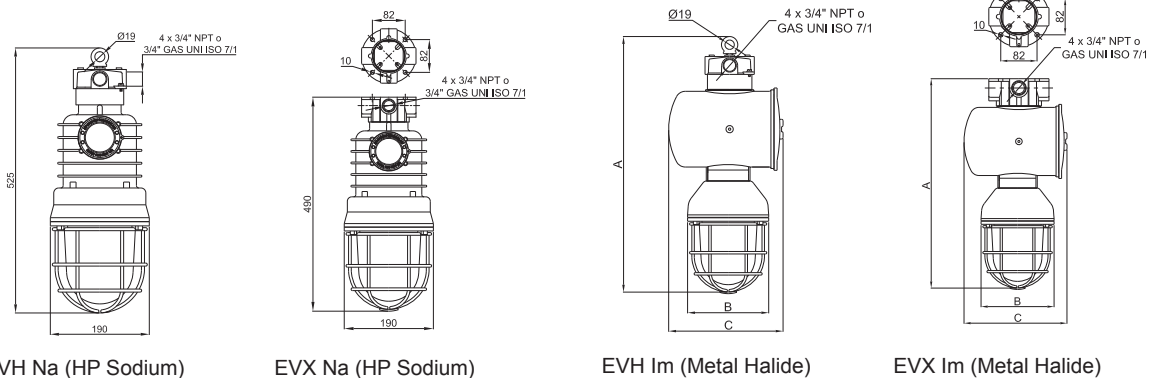

EVXNa Range - HP Sodium

Type	Rating (W)	Lamps	Nominal (A)	Dimensions (mm)		T°C Class	Weight in (kg)
				A/A'	B		
EVXNa20-00000	70	E27 Elliptical	0.40	470/500	200	T4	6.5
EVXNa30-00000	150	E40 Elliptical	0.80	600/633	220	T3	9.7
EVXNa40-00000	250	E40 Elliptical	1.30	600/633	220	T3	9.7
EVXNa50-00000	400	E40 Elliptical	2.10	630/670	270	T3	12

*Suspension ring mounted version, remove X and add H, e.g. EVHNa20-00000

EVXIm Range - Metal Halide

Type	Rating (W)	Lamps	Nominal (A)	Dimensions (mm)		T°C Class	Weight in (kg)
				A/A'	B		
EVXIm40-00000	250	E40 Elliptical	1.30	600/633	220	T3	9.7
EVXIm50-00000	400	E40 Elliptical	2.10	630/670	270	T3	12

*Suspension ring mounted version, remove X and add H, e.g. EVHIm40-00000

EC TYPE Examination Certificate:

IECEX CES 07.0004

CESI 12 ATEX 006

GOST R

II 2 GD

Ex d IIC T...°C Gb

Ex tb IIIC T...°C Db IP66

Enclosure

Body in marine grade aluminium alloy
(CU<0.05%) Yellow polyurethane paint RAL1003
Borosilicate glass globe
Galvanised steel protection grill
Ingress rating: IP65 (EN60529), neoprene ingress gasket
Stainless steel screws

Temperature

Ambient temperature range:-20°C to +60°C
Surface temperature classification: T4 to T3 (gas)

Rated voltages

HP Sodium metal halide
Standard: 230V 50Hz compensated,
wirewound ballast

Power factor

Up to 0.85 (HP Sodium and metal halide)

Cable entries

EVH: four 3/4" NPT entries - fitted 2 plugs
EVX: four 3/4" NPT entries - fitted 2 plugs
Variants: Other options available on request

Terminal block

Up to 6mm² (rigid wire), 4mm² (flexible wire)

Lamps

Not supplied (order separately)

Fixing

Ceiling screw M8 (EVX)
Suspension ring (EVH)
Spare part: 30° angle wall mounting arm (R018)























Ex Boxes & Enclosures





Ex Boxes & Enclosures - Selection Guide

Ex Boxes & Enclosures Range

	 XBL Junction Boxes Page 104	 XBL Instrument Boxes Page 108	 XBL-A Control Boxes Page 110	 XB Instrument Boxes Page 112	 XB-A Control Boxes Page 114	 XBi Instrument Boxes Page 116	 XBi-A Control Boxes Page 118
	●	●	●	●	●	●	●
	●	●	●	●	●	●	●
Protection Type		●	●	●	●	●	●
							
				●	●		●
		●	●	●	●	●	●
				●	●		●
				●	●		●
Dust Group							
		●	●	●	●	●	●
		●	●	●	●	●	●
Zones		●	●	●	●	●	●
		●	●	●	●	●	●
		●	●	●	●	●	●
		●	●	●	●	●	●

Ex Boxes & Enclosures - Selection Guide



GUJ
Junction
Boxes
Page 120



EFDC
Control
Boxes
Page 122



SRC
Control
Boxes
Page 122



XMC
Control
Boxes
Page 122



EJB
Custom
Built Panel
Page 124



GUB
Custom
Built Panel
Page 128



EJB-V
Boxes with
visible breaking
Page 130





XBL Range XB100 Junction boxes



Approvals / Characteristics



Features

- External mounting points allow for junction boxes to be mounted without removing the lid
- Robust design
- Manufactured from anti static GRP so eliminating any chance of static build up
- Supplied complete with terminals and glands so all on site combinations are covered

Certification & Standards

Approved to: EN60079-0, 60079-7, 60079-11, 60079-31
 EC TYPE Examination Certificate: Under 94/9/EC
 LCIE 11 ATEX 3049X / IECEx LCI 11.0045X
 Ex II 2 G / II 2 D
 Ex e II T6 to T4 Gb
 Ex tb IIIC T85°C to T135°C Db IP66
 T6: -20°C to 40°C
 T5: -20°C to 55°C
 T4: -20°C to 90°C
 Glow wire test: 960°C EN60598-2-22

Ex Boxes & Enclosures - XBL Range

Dimensions

Technical Specifications

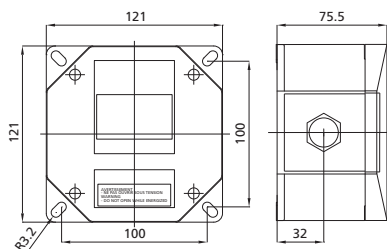

Type	No. of Entries	Material	Glands		Plug Provided	No. of Connectors	Terminal			Plate Bonding Conductors		
			Gland Size	Thread Size			Type	Section	Connection			
XB100-6BV	4	Poly	M20	6-12mm	1 x M20	6	4 x Grey	6mm ² bridge x2	Screw/Screw	-		
							2 x $\frac{1}{2}$	6mm ² bridge x2	Screw/Screw	-		
XB100-6BR	4	Poly	M20	6-12mm	1 x M20	6	4 x Grey	4mm ² bridge	Spring/Spring	-		
							2 x $\frac{1}{2}$	4mm ² bridge	Spring/Spring	-		
XB100-10BV	4	Poly	3 x M20	6-12mm	1 x M20	6	4 x Grey	10mm ² bridge x2	Screw/Screw	-		
			1 x M32	15-21mm			2 x $\frac{1}{2}$	10mm ² bridge x2	Screw/Screw	-		
XB100A-6BV	4	Nickel Plated Brass	M20*	6-12mm Int.	1 x M20	6	4 x Grey	6mm ² bridge x2	Screw/Screw	Yes		
				8.5-16mm Ext.			2 x $\frac{1}{2}$	6mm ² bridge x2	Screw/Screw	-		
XB100A-6BR	4	Nickel Plated Brass	M20*	6-12mm Int.	1 x M20	6	4 x Grey	4mm ² bridge x2	Spring/Spring	Yes		
				8.5-16mm Ext.			2 x $\frac{1}{2}$	4mm ² bridge x2	Spring/Spring	-		
XB100A-10BV	4	Nickel Plated Brass	3 x M20*	6-12mm Int.	1 x M20	6	4 x Grey	10mm ² bridge x2	Screw/Screw	Yes		
				8.5-16mm Ext.								
			1 x M32*	12-20mm Int.			2 x $\frac{1}{2}$	10mm ² bridge x2	Screw/Screw	-		
			16-26mm Ext.									

*for armoured cable

Gland Size	Gland Type
M20	EXCGM20S
M32	EXCGM32S
M20*	EX04MMC1
M32*	EXN06MSC1



XFF Range 28



Nylon Stopping Plugs 176



EVS Range 42



Exe Nylon Gland 168

Related Products



XBL Range Junction boxes



Approvals / Characteristics

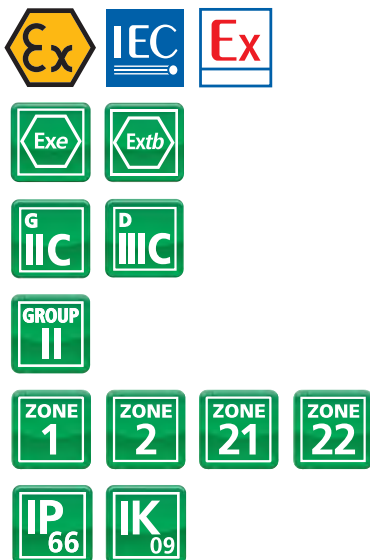

Features

- Robust design
- Manufactured from anti static GRP to eliminate static build up
- Supplied complete with terminals and glands so all on site combinations are covered

Certification & Standards

Approved to: EN60079-0, 60079-7, 60079-11, 60079-31
 EC TYPE Examination Certificate: Under 94/9/EC
 LCIE 11 ATEX 3049X / IECEx LCI 11.0045X
 Ex II 2 G / II 2 D
 Ex e II T6 to T4 Gb
 Ex ia IIC T6
 Ex tb IIC T85°C to T135°C Db IP66
 T6: -20°C to 40°C
 T5: -20°C to 55°C
 T4: -20°C to 90°C
 Glow wire test: 960°C EN60598-2-22

Ex Boxes & Enclosures - XBL Range

Dimensions

Technical Specifications

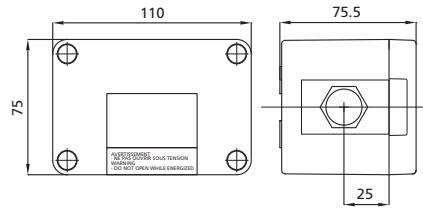

Type	No. of Entries	Material	Glands		Plug Provided	No. of Connectors	Terminal		Plate Bonding Conductors
			Gland Size	Thread Size			Section	Connection	
XBL28-25BR	6	Poly	M20	6-12mm	1 x M20	3	8 x 2, 5mm ² deck	Spring/Spring	-
XBL26-25R	4	Poly	M20	6-12mm	1 x M20	3	4 x 2, 5mm ² deck	Spring/Spring	-

Gland Size	Gland Type
M20	EXCGM20S

XB10-SI Boxes for connecting SI Sensors (for Instrumentation Box Zone 0 Products)

Dimensions

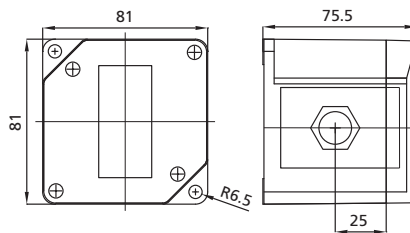

Type	No. of Entries	Material	Glands		Plug Provided	No. of Connectors	Colour	Terminal		Plate Bonding Conductors
			Gland Size	Thread Size				Section	Connection	
XB10-SI	3	Poly (Blue)	M16	4.5-10mm	1 x M16	6	4 x Blue	2.5mm ²	Screw/Screw	-
							2 x V/J	2.5mm ²	Screw/Screw	-
XB10A-SI	3	Poly (Blue)	M16	4.5-10mm	1 x M16	6	4 x Blue	2.5mm ²	Screw/Screw	Yes
		Nickel Plated Brass	M20*	6-12mm Int. 8.5-16mm Ext.			2 x V/J	2.5mm ²	Screw/Screw	

*For armoured cable

Type	Connection	Nominal Section	Maximum Intensity
XB10-SI	Rigid	0.5 - 6mm ²	21A
	Semi Rigid	0.5 - 4mm ²	
XB10A-SI	Flexible	0.5 - 4mm ²	21A
	Flexible Tip	0.5 - 2.5mm ²	

Gland Size	Gland Type
M16	EXCGM16S
M20	EXCGM20S
M20*	EXC03MMC1



XFF Range 28



Nylon Stopping Plugs 176



EVS Range 42



Exe Nylon Gland 168

Related Products



XBL Range Instrumentation boxes



Approvals / Characteristics

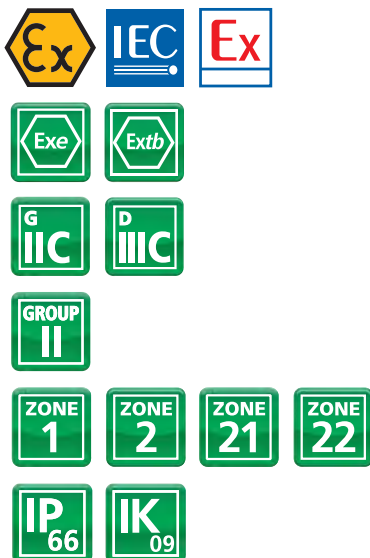

Features

- Robust design
- Manufactured from anti static GRP to eliminate static build up
- Can be supplied complete with terminals and glands so all on site combinations are covered

Certification & Standards

Approved to: EN60079-0, 60079-1, 60079-7, 60079-11, 60079-31
 EC TYPE Examination Certificate: Under 94/9/EC
 LCIE 11 ATEX 3049X / IECEx LCI 11.0045X
 Ex II 2 G / D
 Ex e or ia or eia IIC T6, T5 or T4 Gb
 Ex tb IIIC T85°C to T135°C Db IP66
 T4: ≤ -20°C to ≤ +90°C
 T5: ≤ -20°C to ≤ +55°C
 T6: ≤ -20°C to ≤ +40°C
 LCIE 11 ATEX 3035 U / IECEx LCI 11.0028U
 Ex e IIC Gb
 Ex tb IIIC Db IP66
 Glow wire test: 960°C EN60598-2-22

Ex Boxes & Enclosures - XBL Range

Dimensions

Technical Specifications

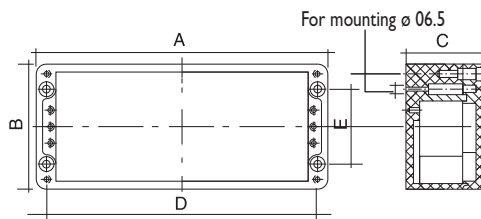

Type	Material	Dimensions (mm)					Maximum number of terminals											Weight in (kg)
		A	B	C	D	E	2.5/21	4/28	6/36	10/50	16/66	35/109	70/167	70/95/100	120/234	185/307	240/350	
XBL15	Poly	122	120	91	106	82	13	11	8	6	-	-	-	-	-	-	-	0.8
XBL20	Poly	110	75	75	98	45	11 (Min)	9 (Min)	-	-	-	-	-	-	-	-	-	0.4
XBL25	Poly	220	120	91	204	82	33	28	21	16	-	-	-	-	-	-	-	1.1
XBL35	Poly	360	160	91	340	110	60	50	38	30	25	-	-	-	-	-	-	2.2
XBL40	Poly	405	400	121	380	355	204	171	129	68	58	21	-	-	-	-	-	5.6
XBL45	Poly	400	250	121	380	200	136	114	86	34	29	21	-	-	-	-	-	3.7
XBL55	Poly	400	250	161	380	200	136	114	86	34	29	21	17	-	-	-	-	4.8
XBL65	Poly	600	250	121	580	200	216	180	136	54	45	34	-	-	-	-	-	5.2
XBL75	Poly	405	605	252	370	570	312	261	130	104	86	32	25	19	6	5	5	7.2

Enclosure

Fiberglass reinforced polyester with graphite finish (R<1G Ohm)
Stainless steel unlosable screws
Optional hinges

Rated voltages

Depending on the components fitted in the box (eg:with terminal block: Un max = 500V)

Cable entries

ISO entries and threads
Nylon cable glands for non-armoured cable
Nickel Plated Brass cable glands for armoured and non-armoured cable require brass continuity plate on XBL

Terminal block

Can be supplied with Exe or Exia terminal blocks
The maximum number of terminal blocks per box is dependent on the certification
Stainless steel external earth
Other options available upon request

For full details and design service contact Sales



XFF Range 28



Nylon Stopping Plugs 176



EVS Range 42



Exe Nylon Gland 168

Related Products



XBL-A Range Standard control boxes



Approvals / Characteristics



Features

- Wide variety of sizes and functions available as standard products for speed of supply and custom built to meet the end users exact requirements
- All manufactured with approved components
- Manufactured from anti static GRP to eliminate static build up

Certification & Standards

Approved to: EN60079-0, 60079-1, 60079-7, 60079-11, 60079-31
 EC TYPE Examination Certificate: Under 94/9/EC
 LCIE 11 ATEX 3049X / IECEx LCI 11.0045X
 Ex II 2 G / D
 Ex de or e or ia or eia IIC T6, T5 or T4 Gb
 Ex tb IIIC T85°C to T135°C Db IP66
 T4: ≤ -20°C to ≤ +90°C
 T5: ≤ -20°C to ≤ +55°C
 T6: ≤ -20°C to ≤ +40°C
 Glow wire test: 960°C EN60598-2-22

Ex Boxes & Enclosures - XBL-A Range

Dimensions

Technical Specifications

Standard Configurations

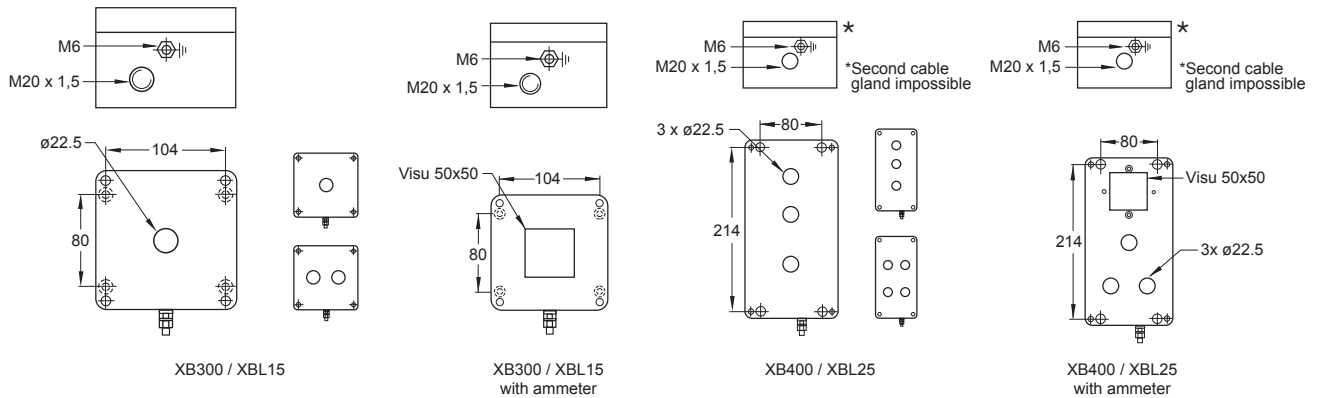

Type	XBL: 122 x 120 x 91 (mm)						XBL: 220 x 120 x 91 (mm)							
	1 Function			2 Functions		Ammeter	3 Functions			4 Functions		Ammeter		
	21A	21FA	21VA	215A	215VA	22A	23A	AMP	26A	38A	41A	43A	22AMP	38AMP
Green Push Button 1 NO	●	-	-	-	-	●	●	-	●	●	●	●	●	●
Emergency Stop PB Push/Pull 1 NC	-	●	-	-	-	-	-	-	●	-	-	-	-	-
Emergency Stop PB Push/Pull 1 NC with Key 455	-	-	●	-	-	-	-	-	-	-	-	-	-	-
Switch 0-1, 2NO	-	-	-	●	-	-	-	-	-	●	-	-	-	●
Switch with Key 0-1, 1 NO	-	-	-	-	●	-	-	-	-	-	-	-	-	-
Red Push Button 1 NC	-	-	-	-	-	●	-	-	-	●	●	●	●	●
Green Indicator Lamp	-	-	-	-	-	-	●	-	●	-	●	●	-	-
Red Indicator Lamp	-	-	-	-	-	-	-	-	-	-	-	●	-	-
Ammeter TC/IA Graduate Scale 0-In-3In dilo IN= to be indicated	-	-	-	-	-	-	-	●	-	-	-	-	●	●
Front Plug	-	-	-	-	-	-	-	-	-	-	-	-	●	-

*Add function to complete part number, e.g. XBL21A

Enclosure

XBL-A: Fiberglass reinforced polyester with graphite finish (R< 1 Gohm)
Stainless steel unlosable screws
Optional hinges

Protection class: I

Technical Characteristics

AC: U = 415V max. I = 1,75A or U = 240V, I = 3A or U = 120V, I = 6A
DC: U = 415V max. I = 0,165A or U = 250V, I = 0,27A or U = 125V, I = 0,55A

Cable entries

ISO entries and threads
Nylon cable glands for non-armoured cable
Nickel Plated Brass cable glands for non- armoured cable (order separately)
Nickel Plated Brass cable glands for armoured and non-armoured cable require brass continuity plate on XBL (order separately)

Components

Drilling or request
Full range indicator lamp with LED Voltage of use 24V-254V AC/DC
Push button (green, red, black, yellow or blue) 1 contact (3 contacts maximum)
Emergency stop 1 contact (3 contacts maximum)
Rotary switch 2 or 3 positions (2 contacts maximum)
Ammeter Ex: direct 1A or with CT/1Amp. max.

For Accessories see page 132



XFF Range 28



Stopping Plugs 176



EVS Range 42



Exe Nylon Gland 168

Related Products



XB Range Instrumentation boxes



Approvals / Characteristics

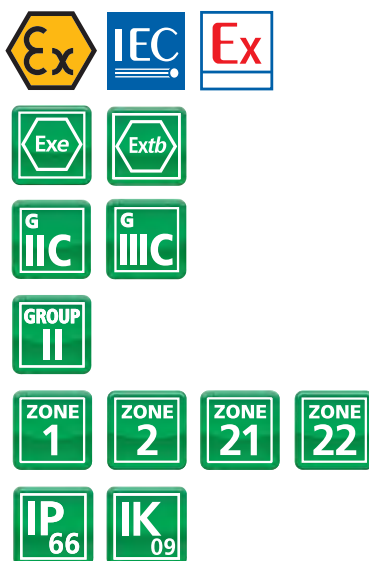

Features

- Robust design and paint finish ideal for marine applications
- Can be supplied complete with terminals and glands so all on site combinations are covered

Certification & Standards

Approved to: EN60079-0, 60079-1, 60079-7, 60079-11, 60079-31
 EC TYPE Examination Certificate: Under 94/9/EC
 LCIE 11 ATEX 3051X / IECEx LCI 11.0046X
 Ex II 2 G / D
 Ex e or ia or eia IIC T6, T5 or T4 Gb
 Ex tb IIIC T85°C to T135°C Db IP66
 T4: ≤ -20°C to ≤ +90°C
 T5: ≤ -20°C to ≤ +55°C
 T6: ≤ -20°C to ≤ +40°C
 LCIE 11 ATEX 3046 U / IECEx LCI 11.0043U
 Ex e IIC Gb
 Ex tb IIIC Db IP66

Ex Boxes & Enclosures - XB Range

Dimensions

Technical Specifications

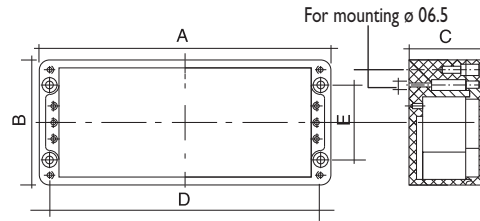

Type	Material	Dimensions (mm)					Maximum number of terminals											Weight in (kg)	
		A	B	C	D	E	2.5/21	4/28	6/36	10/50	16/66	35/109	70/167	70/95/100	120/234	185/307	240/350		
XB300	Alu	122	120	91	106	82	13	11	8	6	-	-	-	-	-	-	-	-	1.0
XB400	Alu	220	120	91	204	82	33	27	21	16	-	-	-	-	-	-	-	1.4	
XB510	Alu	160	160	91	140	110	20	17	13	10	-	-	-	-	-	-	-	1.5	
XB520	Alu	260	160	91	240	110	40	33	25	20	-	-	-	-	-	-	-	2.0	
XB570	Alu	202	232	111	180	180	56	46	36	14	11	9	-	-	-	-	-	2.4	
XB700	Alu	360	160	91	340	110	61	50	38	30	-	-	-	-	-	-	-	2.5	
XB710	Alu	330	230	111	310	180	108	90	68	54	22	17	15	-	-	-	-	3.4	
XB750	Alu	403	312	141	382	262	204	171	129	51	42	21	16	-	-	-	-	6.7	
XB950	Alu	600	230	111	580	260	216	180	134	54	45	33	-	19	6	5	5	7.0	
XB960	Alu	600	600	202	555	525	432	360	204	162	135	132	39	20	11	9	9	26.0	

Enclosure

Aluminium ALSi 12, yellow polyurethane paint
RAL 1003 (other colours available on request)
Stainless steel unlosable screws
Optional hinges

Rated voltages

Depending on the components fitted in the box
(eg:with terminal block: Un max = 500V)

Cable entries

ISO entries and threads
Nylon cable glands for non-armoured cable
Nickel Plated Brass cable glands for
armoured cable (order separately)

Terminal block

Can be supplied with Exe or Exia terminal blocks
The maximum number of terminal blocks per box is
dependent on the certification
Stainless steel external earth
Other options available upon request

For full details and design service contact Sales



EJB Range 126



Stopping Plugs 176



EVS Range 42



ExeNylon Gland 168

Related Products



XB-A Range Standard control boxes



Approvals / Characteristics



Features

- Wide variety of sizes and functions available as standard products for speed of supply and custom built to meet the end users exact requirements
- All manufactured with approved components
- Manufactured from aluminium ideal for marine applications

Certification & Standards

Approved to: EN60079-0, 60079-1, 60079-7, 60079-11, 60079-31
 EC TYPE Examination Certificate: Under 94/9/EC
 LCIE 11 ATEX 3051X / IECEx LCI 11.0046X
 Ex II 2 G / D
 Ex de or e or ia or eia IIC T6, T5 or T4 Gb
 Ex tb IIC T85°C to T135°C Db IP66
 T4: ≤ -20°C to ≤ +90°C
 T5: ≤ -20°C to ≤ +55°C
 T6: ≤ -20°C to ≤ +40°C

Dimensions

Technical Specifications

Standard Configurations

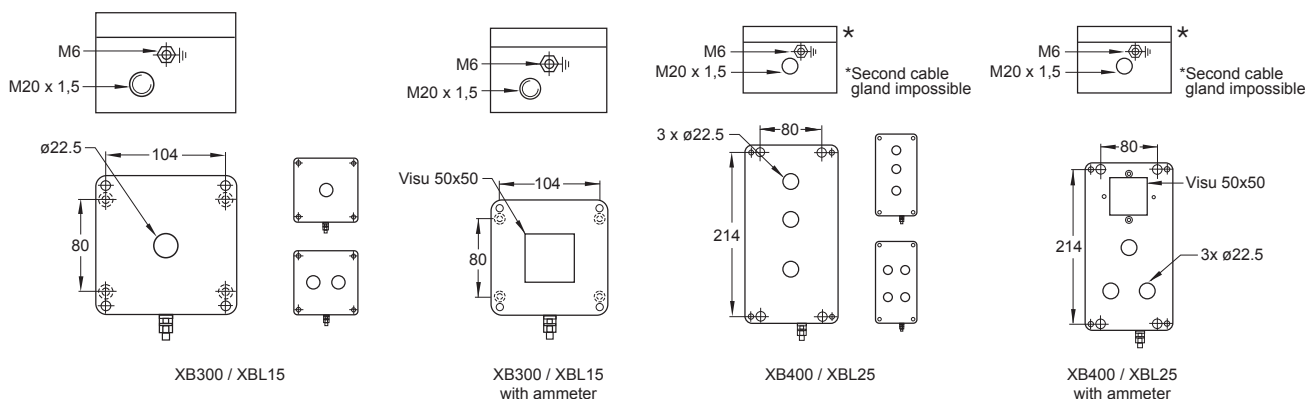

Type	XB: 122 x 120 x 91 (mm)					XB: 220 x 120 x 91 (mm)								
	1 Function		2 Functions		Ammeter	3 Functions		4 Functions		Ammeter				
	21A	21FA	21VA	215A	215VA	22A	23A	AMP	26A	38A	41A	43A	22AMP	38AMP
Green Push Button 1 NO	●	-	-	-	-	●	●	-	●	●	●	●	●	●
Emergency Stop PB Push/Pull 1 NC	-	●	-	-	-	-	-	-	●	-	-	-	-	-
Emergency Stop PB Push/Pull 1 NC with Key 455	-	-	●	-	-	-	-	-	-	-	-	-	-	-
Switch 0-1, 2NO	-	-	-	●	-	-	-	-	-	●	-	-	-	●
Switch with Key 0-1, 1NO	-	-	-	-	●	-	-	-	-	-	-	-	-	-
Red Push Button 1 NC	-	-	-	-	-	●	-	-	-	●	●	●	●	●
Green Indicator Lamp	-	-	-	-	-	-	●	-	●	-	●	●	-	-
Red Indicator Lamp	-	-	-	-	-	-	-	-	-	-	-	●	-	-
Ammeter TC/IA Graduate Scale 0-In-3In dilo IN= to be indicated	-	-	-	-	-	-	-	●	-	-	-	-	●	●
Front Plug	-	-	-	-	-	-	-	-	-	-	-	-	●	-

*Add function to complete part number, e.g. XB21A

Enclosure

XB-A: Aluminium ALSi 12, yellow polyurethane paint RAL1003 (other colours on request)
Stainless steel unlosable screws

Protection class: I

Technical Characteristics

AC: U = 415V max. I = 1,75A or U = 240V, I = 3A or U = 120V, I = 6A
DC: U = 415V max. I = 0,165A or U = 250V, I = 0,27A or U = 125V, I = 0,55A

Cable entries

ISO entries and threads
Nylon cable glands for non-armoured cable
Nickel Plated Brass cable glands for armoured cable (order separately)

Components

Indicator lamp with LED Voltage of use 24V-254V AC/DC
Push button (green, red) 1 contact
Emergency stop 1 contact
Rotary switch 2 positions (2 contacts maximum)
Ammeter Ex e: direct 1A or with CT/1Amp. max.

For Accessories see page 132



EJB Range 126



Stopping Plugs 176



EVS Range 42



ExeNylonGland 168

Related Products



XBi Range Instrumentation boxes



Approvals / Characteristics

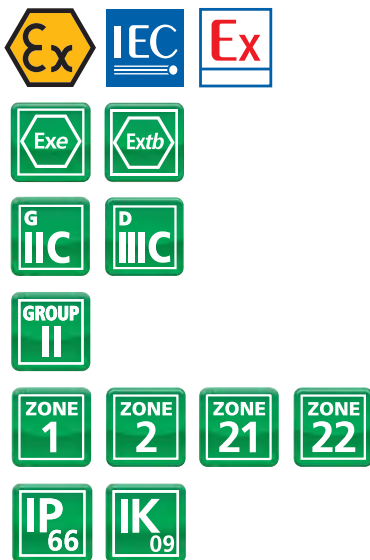

Features

- Robust design
- Manufactured from stainless steel 316 so ideal for offshore applications
- Can be supplied complete with terminals and glands so all on site combinations are covered

Certification & Standards

Approved to: EN60079-0, 60079-1, 60079-7, 60079-11, 60079-31
 EC TYPE Examination Certificate: Under 94/9/EC
 LCIE 11 ATEX 3050X / IECEx LCI 11.0044X
 Ex II 2 G / D
 Ex e or ia or eia IIC T6, T5 or T4 Gb
 Ex tb IIIC T85°C to T135°C Db IP66
 T4: ≤ -20°C to ≤ +90°C
 T5: ≤ -20°C to ≤ +55°C
 T6: ≤ -20°C to ≤ +40°C
 LCIE 11 ATEX 3045 U / IECEx LCI 11.0041U
 Ex e IIC Gb
 Ex tb IIIC Db IP66

Ex Boxes & Enclosures - XBi Range

Dimensions

Technical Specifications

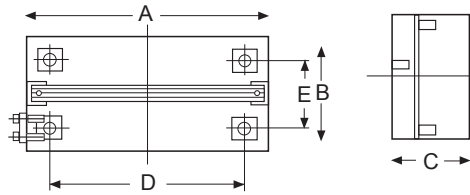

Type	Material	Dimensions (mm)					Maximum number of terminals size (in mm ²) / In Max (in A)											Weight in (kg)	
		A	B	C	D	E	2.5/21	4/28	6/36	10/50	16/66	35/109	70/167	70/95/100	120/234	185/307	240/350		
XBi100	316L S/S	100	100	61	60	60	9 (Min)	8 (Min)	-	-	-	-	-	-	-	-	-	-	0.8
XBi150	316L S/S	150	150	81	110	110	19	16	12	10	-	-	-	-	-	-	-	0.4	
XBi200	316L S/S	200	100	61	160	110	29 (Min)	24 (Min)	-	-	-	-	-	-	-	-	-	1.1	
XBi300	316L S/S	300	200	81	260	160	98	80	60	25	-	-	-	-	-	-	-	2.2	
XBi400	316L S/S	400	300	161	360	260	138	116	86	70	56	21	17	-	-	-	-	5.6	
XBi500	316L S/S	500	400	161	460	360	356	296	224	135	87	46	14	11	-	-	-	3.7	
XBi600	316L S/S	600	200	121	560	360	218	182	136	55	45	34	-	-	-	-	-	4.8	

Enclosure

316L stainless steel, 1.25mm thick
Stainless steel unlosable screws
Optional hinges

Rated voltages

Depending on the components fitted in the box
(eg: with terminal block: Un max = 500V)

Cable entries

ISO entries and threads
Nylon cable glands for non-armoured cable
Nickel Plated Brass cable glands for non-armoured cable (order separately)

Terminal block

Can be supplied with either Exe or Exia Terminal blocks
The maximum number of terminal blocks per box is dependent on the certification
Stainless steel external earth
Other options available upon request

For full details and design service contact Sales



EJB Range 126



Stopping Plugs 176



EVS Range 42



Exe Nylon Gland 168

Related Products



XBi-A Range Standard control boxes



Approvals / Characteristics



Features

- Robust design
- Manufactured from stainless steel 316 so ideal for offshore applications

Certification & Standards

Approved to: EN60079-0, 60079-1, 60079-7, 60079-11, 60079-31
 EC TYPE Examination Certificate: Under 94/9/EC
 LCIE 11 ATEX 3050 / IECEx LCI 11.0044
 Ex II 2 G / D
 Ex de or e or ia or eia IIC T6, T5 or T4 Gb
 Ex tb IIIC T85°C to T135°C DB IP66
 Ex de IIC T6, T5 or T4 IP66
 T4: ≤ -20°C to ≤ +90°C
 T5: ≤ -20°C to ≤ +55°C
 T6: ≤ -20°C to ≤ +40°C
 Glow wire test: 960°C EN60598-2-22

Dimensions

Technical Specifications

Standard Configurations

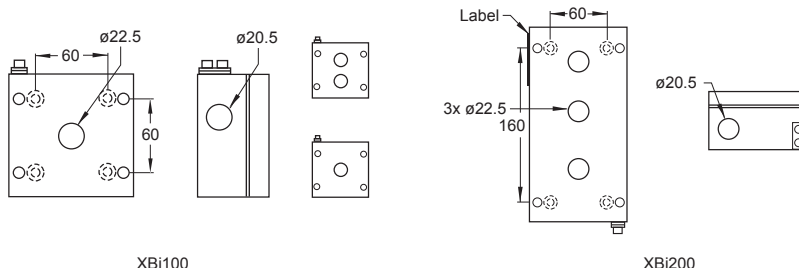

XBi100

XBi200

Type	XBi: 100 x 100 x 61 (mm)						XBi: 200 x 100 x 61 (mm)				
	1 Function			2 Functions			3 Functions		4 Functions		
	21A	21FA	21VA	215A	215VA	22A	23A	26A	38A	41A	43A
Green Push Button 1 NO	●	-	-	-	-	●	●	●	●	●	●
Emergency Stop PB Push/Pull 1NC	-	●	-	-	-	-	-	●	-	-	-
Emergency Stop PB Push/Pull 1NC with Key 455	-	-	●	-	-	-	-	-	-	-	-
Switch 0-1, 2NO	-	-	-	●	-	-	-	-	●	-	-
Switch with Key 0-1, 1NO	-	-	-	-	●	-	-	-	-	-	-
Red Push Button 1 NC	-	-	-	-	-	●	-	-	●	●	●
Green Indicator Lamp	-	-	-	-	-	-	●	●	-	●	●
Red Indicator Lamp	-	-	-	-	-	-	-	-	-	-	●
Ammeter TC/IA Graduate Scale 0-In-3In dilo IN= to be indicated	-	-	-	-	-	-	-	-	-	-	-
Front Plug	-	-	-	-	-	-	-	-	-	-	-

*Add function to complete part number, e.g. XBi21A

Enclosure

XBi-A: 316L stainless steel,
1.25mm thick
Stainless steel unlosable screws

Protection class: I

Technical Characteristics

AC: U = 415V max. I = 1,75A or U = 240V, I = 3A or
U = 120V, I = 6A
DC: U = 415V max. I = 0,165A or U = 250V,
I = 0,27A or U = 125V, I = 0,55A

Cable entries

ISO entries and threads
Nylon cable glands for non-armoured cable
Nickel Plated Brass cable glands for
armoured cable (order separately)

Components

Full range indicator lamp with LED Voltage of use
24V-254V AC/DC
Push button (green, red, black, yellow or blue) 1
contact (2 contacts maximum)
Emergency stop 1 contact (2 contacts maximum)
Rotary switch 2 or 3 positions (2 contacts maximum)
Ammeter Ex e: direct 1A or with CT/1Amp. max.

For Accessories see page 132



EJB Range 126



Stopping Plugs 176



EVS Range 42



Exe Nylon Gland 168

Related Products



GUV Range Aluminium junction boxes



Approvals / Characteristics



Features

- External mounting points allow junction boxes to be mounted without removing the lid
- Robust design in cast aluminium
- Bright yellow paint (RAL-1003) for high visibility

Certification & Standards

Approved to: EN60079-0, 60079-1
 EC TYPE Examination Certificate:
 LCIE 00 ATEX 6022 / IECEx in progress
 Ex II 2 G
 Ex d IIC T6 to T4
 LCIE 00 ATEX 6022
 T6: ≤ -20°C to ≤ +40°C
 T5: ≤ -20°C to ≤ +55°C
 T4: ≤ -20°C to ≤ +60°C

Dimensions

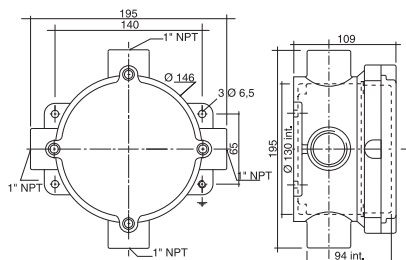
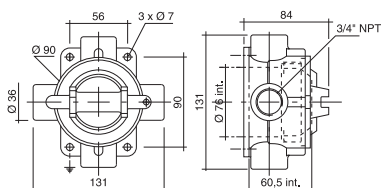

Technical Specifications

Type	Number of entries	Number of terminals (optional)	Weight (Kg)
GUVC26-00000	2 -c-	4 x 2.5 to 6mm ²	0.6
GUVC36-00000	2 -c-	Max 8 x 25mm ² or 6 x 35mm ²	1.6
GUVL26-00000	2 i-	4 x 2.5 to 6mm ²	0.6
GUVL36-00000	2 i-	Max 8 x 25mm ² or 6 x 35mm ²	1.6
GUVT26-00000	3 T-	4 x 2.5 to 6mm ²	0.6
GUVT36-00000	3 T-	Max 8 x 25mm ² or 6 x 35mm ²	1.7
GUVX26-00000	4 X-	4 x 2.5 to 6mm ²	0.7
GUVX36-00000	4 X-	Max 8 x 25mm ² or 6 x 35mm ²	1.8

Enclosure

Aluminium alloy body EN 1706 AC - 43100KF - AISI 10Mg

Yellow polyurethane paint RAL1003

Stainless steel screws

Cable entries

Standard: Two to four 3/4" NPT entries

Cable glands and plugs can be ordered separately

Terminals

GUV26:

4 terminals up to 6mm² (order separately)

4 interconnected earthing terminals with one 4mm clamping screws per each terminal

GUV36:

Terminals (order separately)

Maximum number 8 x 25mm² terminals or 6 x 35mm² terminals

Other options (order separately)

Terminal 4 x 6mm² (G03)

Terminal 6 x 4mm² (G005)

Terminal 10 x 4mm² (G006)

Terminal 4 x 10mm² (G009)

Terminal 5 x 10mm² (G0010)

Terminal 4 x 16mm² (G0011)

Terminal 8 x 16mm² (G0015)

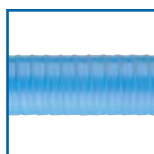

EXL Conduit 148



Stopping Plugs 176



XFF Range 28



Ex d Cable Gland 162

Related Products



EFDC / SRC / XMC Range Control stations



Approvals / Characteristics



Features

- Ex d approved for hazardous locations
- Manufactured from cast aluminium and machined with a cylindrical spigot joint flame path

Certification & Standards

Approved to: EN60079-0, 60079-1

EC TYPE Examination Certificate:

LCIE 00 ATEX 6022 / IECEx in progress

Ex II 2 G

Ex d IIC T6 to T4

Type (without light): EFDC, SRC

T6: ≤ -20°C to ≤ +40°C

T5: ≤ -20°C to ≤ +55°C

T4: ≤ -20°C to ≤ +60°C

Type (with light): EFDC, SRC

T6: ≤ -20°C to ≤ +40°C

Ex Boxes & Enclosures - EFDC / SRC / XMC Range

Dimensions

Technical Specifications

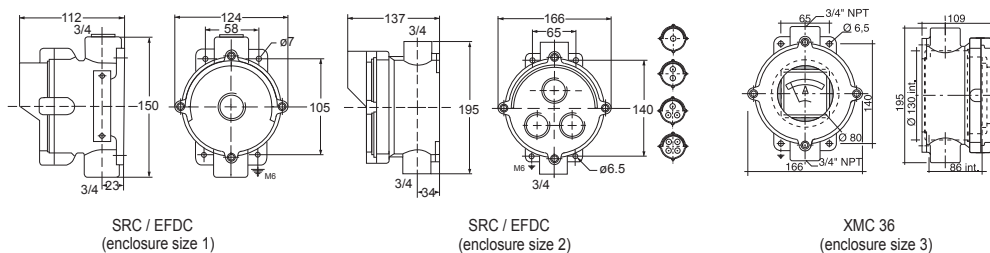

Type EFDC	21	25	41	43	44	22	40	42	38	23	21F	21V	21G	21P	24	23A	39	37	36
Green Push Button NO+NC	●	-	●	●	●	●	●	-	●	●	-	-	-	-	-	-	-	-	-
2 x Green Push button NO+NC	-	-	-	-	-	-	-	●	-	-	-	-	-	-	-	-	-	-	-
Push/Pull Emergency Button NO+NF	-	●	-	-	-	-	-	-	-	-	●	-	-	-	-	-	-	-	-
Emergency Key Operated Push Button 455 NO+NF	-	-	-	-	-	-	-	-	-	-	-	●	-	-	-	-	-	-	-
Break Glass Automatic Cut-off NO+NC	-	-	-	-	-	-	-	-	-	-	-	-	●	-	-	-	-	-	-
Potentiometer Driver	-	-	-	-	-	-	-	-	-	-	-	-	-	●	-	-	-	-	-
Green Indicator Lamp 230V	-	●	●	●	●	-	-	-	-	●	-	-	-	-	●	●	●	●	-
Red Push Button NO+NC	-	-	●	●	●	●	●	-	●	-	-	-	-	-	-	-	-	-	-
2 x Red Push Button NO+NC	-	-	-	-	-	-	-	●	-	-	-	-	-	-	-	-	-	-	-
Red Indicator Lamp 230V	-	-	-	●	-	-	-	-	-	-	-	-	-	-	-	●	●	-	-
Push Button Black NO+NC	-	-	-	-	●	-	●	-	-	-	-	-	-	-	-	-	-	-	-
Rotary Switch Unit 16A 2 NO	-	-	-	-	-	-	-	-	●	-	-	-	-	-	-	-	●	●	-
2 x Rotary Switch Unit 16A 2 NO	-	-	-	-	-	-	-	-	-	-	-	-	-	-	-	-	-	-	●
Type SRC Rotary Switch Unit	215	415	330	340	215V														
16A 2NO	●	-	-	-	●														
32A 3NO Lockable	-	-	●	-	-														
40A 3NO Lockable	-	-	-	-	●														
With Key 455	-	-	-	-	-														
16A 4 NO	-	●	-	-	-														
Type XMC																			
XMC36	1 display diameter 80 with base plate - no equipment																		
*Add function to complete part number, e.g. EDFC21, SRC215, XMC36																			

Enclosure

Body in marine grade aluminium alloy
EN1706 AC - 43100KF - AISI 10Mg
Polyurethane paint: yellow RAL1003 except
EFDC21G (red paint RAL3001)
Stainless steel screws
Volume < 2 dm³

Power supply

Maximum operating power: 400 Vac max for the
indicator lamps
6 A max for the push buttons
40 A max for the rotary switches
For indicator and potentiometer: please enquire

Cable entries

Standard: Two 3/4" NPT one being equipped with
one Nickel Plated Brass plug
Cable glands ordered separately

Recommendation:

 For proper selection of cable glands in
hazardous locations, refer to EN60079-14

Terminal blocks

Directly connected to the accessory / component,
as required.

For Accessories see page 132

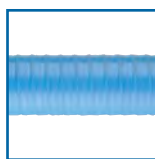

EXL Conduit 148



Stopping Plugs 176



XFF Range 28

Related Products

Custom Built Enclosures





Custom built Ex d enclosures & panels

DTS Ex d control panels are constructed & tested according to ATEX protection type Ex d.

Available with a wide variety of components such as switches, contactors and relays, which can be mounted into explosionproof enclosures constructed to keep internal explosions from igniting the surrounding atmosphere.

Ex d control panels are usually custom-built in cooperation with the customer to suit their specific application requirements.



EJB Range Custom built panels



Approvals / Characteristics



Features

- Robust construction
- Wide variety of sizes
- Large choice of electrical components
- Customised to user's specification

Certification & Standards

Approved to: EN60079-0, 60079-1

EC TYPE Examination Certificate:

INERIS 11 ATEX 0050X

Ex II 2 G

Ex d IIB T5 or T6 Gb

Ex II 2 (1) G

Ex d (ia IIC Ga, or ib, or ib IIC, or ia Ga) IIB T6 Gb

Safe operating temperature range: -20°C to +40°C



For installations in either Zone 1 or in the presence of Group IIC gases, barrier glands are required. Please refer to EN-60079-14

Dimensions

Technical Specifications

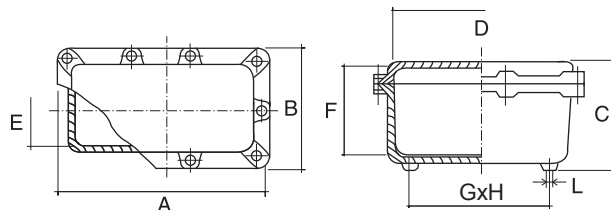

Type	External			Internal			Fixing / Mounting			Internal Plate (mm)	Weight (kg)
	A	B	C	D	E	F	G	H	L		
EJB0	200	145	130	145	90	90	140	85	M6	138 x 85	4
EJB1	302	190	170	225	115	130	200	100	M6	215 x 110	8
EJB2	295	230	165	225	165	132	185	130	M6	220 x 160	9
EJB4	410	300	167	340	220	127	290	190	M8	320 x 210	16
EJB5	475	295	220	390	207	179	335	178	M8	380 x 200	18
EJB8	625	360	250	525	260	195	480	210	M8	510 x 250	33
EJB11	595	505	275	485	395	207	436	335	M10	470 x 380	55
EJB12	805	435	315	690	345	246	605	262	M12	675 x 325	75
EJB13	832	612	323	720	435	252	628	405	M12	790 x 470	92

Enclosure

Marine grade aluminium alloy type EN 1706 AC - 43100KF - AISI 10Mg

Stainless steel external earth

Stainless steel screws

Hinged door if command buttons are on the panel (except EJB0)

Cable entries

NPT or ISO entries and threads as requested:

Nickel Plated Brass, or Stainless Steel cable glands can be supplied (order separately) for either armoured, or non-armoured cables

Switches and Indicators

On request Rotary switches: 1 to X positions two-way, spring return, layout on request (eg : 3NO + 1NC, 1 NO / Position...)

Push buttons: Colours: green, red, black, yellow, blue

Mechanical reactivation

Contacts: maximum 6 contacts as specified, NO

or NC Indicator lamps: Colours: green, red, white, yellow, blue, power supply not exceeding 400V

LEDs

Potentiometer: please advise: value in Ohms, power in W, Number of turns, linear or logarithmic

For all components: legends as requested

Isolating switch/circuit-breaker: up to 800A

Meters behind visual display: ammeter, voltmeter or others upon request

Recommendation

 For installations in either Zone 1 or in the presence of Group IIC gases, barrier glands are required. Please refer to EN-60079-14 (except EJB0 < 2 dm³)

Fixing

4 threaded holes on the back plate (see table)

Frame or supporting feet on request

Colour (standard)

● EJB - Yellow offshore, RAL 1003

Colour options

● EJB - Grey, RAL 7035

● EJB - Black, RAL 9004

● EJB - Hammered Blue, RAL 5015

● EJB - Red, RAL 3001

● EJB - Blue, RAL 5010

● EJB - Green, RAL 6032

○ EJB - White, RAL 9010

For Accessories see page 132

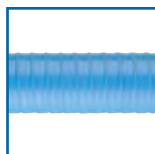

EXL Conduit 148



Stopping Plugs 176



GUV Range 120

Related Products



GUB Range Custom built panels



Approvals / Characteristics



Features

- IIC boxes
- Anti-corrosion and marine protection
- Large internal volume
- Quick and easy opening and closing

Certification & Standards

Approved to: EN 60079-0,60079-1, 61241-0, 61241-1
 EC TYPE Examination Certificate:
 CESI 01 ATEX 036
 Ex II 2 G / D
 Ex d IIC T6 to T5
 Ex tD A21 IP66 T 85°C to T 100°C
 T6: -20°C to +40°C
 T5: -20°C to +55°C



For installations in either Zone 1 or in the presence of Group IIC gases, barrier glands are required. Please refer to EN-60079-14

Dimensions

Technical Specifications

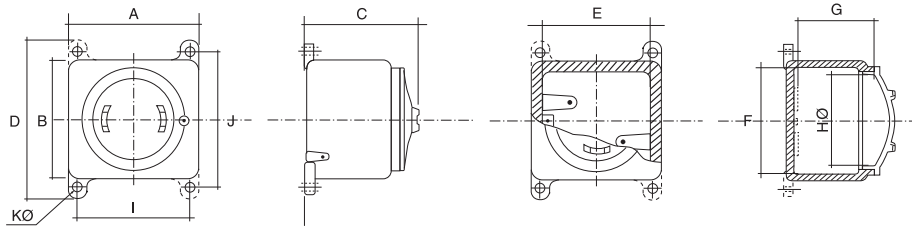

Cable Glands and Plugs Per Side

Type	1/2"				3/4"				1"				1 1/4"				1 1/2"				2"				2 1/2"			
	A	B	C	D	A	B	C	D	A	B	C	D	A	B	C	D	A	B	C	D	A	B	C	D	A	B	C	D
GUB0AS	3	2	1	3	2	1	1	2	1	-	-	1	-	-	-	-	-	-	-	-	-	-	-	-	-	-	-	-
GUB0BS	3	3	2	3	3	3	2	3	2	2	1	2	2	1	1	2	1	1	1	1	-	-	-	-	-	-	-	-
GUB01CS	5	4	3	5	4	4	3	4	3	2	2	3	2	1	1	2	2	1	1	2	1	1	1	1	-	-	-	-
GUB02DS	7	6	6	7	7	6	6	7	5	4	4	2	3	2	2	3	2	2	2	2	2	1	1	2	1	1	1	1
GUB03ES	15	15	15	15	15	14	13	15	8	8	7	8	8	7	6	8	5	4	4	5	3	2	2	3	2	2	1	2
GUB04FS	26	26	26	26	20	19	19	20	14	13	13	14	10	9	9	10	10	9	9	10	8	7	7	8	5	4	4	5

Type	External Dimensions (mm)				Internal Dimensions (mm)				Fixing					KØ	Weight (kg)
	A	B	C	D	E	F	G	H	I	J	KØ				
GUB0AS	120	120	116	166	96	96	54	75	100	145	9	2			
GUB0BS	150	150	130	205	126	126	68	115	126	174	10	3			
GUB01CS	174	174	140	218	146	146	75	115	150	195	10	4			
GUB02DS	230	230	165	302	204	204	85	175	196	267	14	7			
GUB03ES	276	276	217	346	274	256	134	220	236	316	14	12			
GUB04FS	430	430	290	522	398	398	155	360	390	480	14	30			

Enclosure

Marine aluminium alloy body (CU<0.05%)
 Ingress rating IP66 (EN60529)
 Neoprene gasket
 Stainless steel screws

Protection class: I

Cable entries

NPT or ISO threaded entries according to specification
 The fixture is supplied with non-barrier cable glands.
 For installations in either Zone 1, or in the presence of Group IIC gases, barrier glands are required.
 Please refer to EN-60079-14.

Fixing

By fixing lugs incorporated to the box

Colour (standard)

● GUB***-00000 - Yellow offshore, RAL 1003

Colour options

- GUB***-B0000 - Grey, RAL 7035
- GUB***-C0000 - Black, RAL 9004
- GUB***-D0000 - Hammered Blue, RAL 5015
- GUB***-F0000 - Red, RAL 3001
- GUB***-G0000 - Blue, RAL 5010
- GUB***-J0000 - Green, RAL 6032
- GUB***-M0000 - White, RAL 9010

For Accessories see page 132



EXL Conduit 148



Stopping Plugs 176



GUV Range 120

Related Products



EJB-V Range Boxes with visible breaking



Approvals / Characteristics



Features

- Boxes provided with load-break switch
- Visible breaking
- Switch off and on under load and provide safety cut off
- IIB control panels

Certification & Standards

Approved to: EN60079-0, 60079-1

EC TYPE Examination Certificate:

INERIS 11 ATEX 0050X

Ex II 2 G

Ex d IIB T5 or T6 Gb

Ex II 2 (1) G

Ex d IIB T6 Gb

Safe operating temperature range: -20°C to +40°C



For installations in either Zone 1 or in the presence of Group IIC gases, barrier glands are required. Please refer to EN-60079-14

Ex Boxes & Enclosures - EJB-V Range

Dimensions

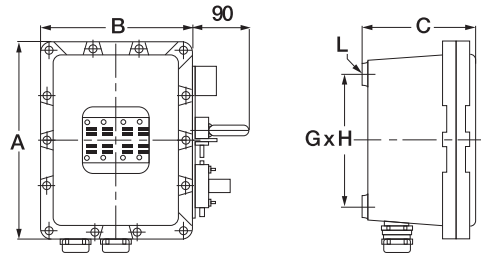

Technical Specifications

Type	Dimensions (mm)						Display Size (mm)	Switching	Gland Number	Plugs	Weight (kg)
	A	B	C	G	H	L					
EJB2-V1	295	230	165	132	185	M6	100 x 100	3 x 50A	2 x 3/4"	1 x 3/4"	9
EJB2-V2	295	230	165	132	185	M6	100 x 100	4 x 50A	2 x 3/4"	1 x 3/4"	9
EJB2-V3	295	230	165	132	185	M6	100 x 100	3 x 80A	2 x 3/4"	1 x 3/4"	9
EJB2-V4	295	230	165	132	185	M6	100 x 100	4 x 80A	2 x 3/4"	1 x 3/4"	9
EJB4-V1	410	300	167	190	290	M8	100 x 100	3 x 125A	2 x 1"	1 x 3/4"	18
EJB4-V2	410	300	167	190	290	M8	100 x 100	4 x 125A	2 x 1"	1 x 3/4"	18
EJB4-V3	410	300	167	190	290	M8	50 x 200	6 x 50A	4 x 3/4"	1 x 3/4"	18
EJB4-V4	410	300	167	190	290	M8	50 x 200	8 x 50A	4 x 3/4"	1 x 3/4"	18
EJB4-V5	410	300	167	190	290	M8	50 x 200	6 x 80A	4 x 3/4"	1 x 3/4"	18
EJB4-V6	410	300	167	190	290	M8	50 x 200	8 x 80A	4 x 3/4"	1 x 3/4"	18
EJB8-V1	625	360	250	210	480	M8	50 x 200	6 x 125A	4 x 1"	1 x 3/4"	35
EJB8-V2	625	360	250	210	480	M8	50 x 200	8 x 125A	4 x 1"	1 x 3/4"	35
EJB8-V3	625	360	250	210	480	M8	100 x 100	3 x 200A	2 x 1"	1 x 3/4"	55
EJB11-V1	595	505	275	355	436	M10	50 x 200	3 x 400A	2 x 2"	1 x 3/4"	55
EJB11-V2	595	505	275	355	436	M10	50 x 200	4 x 400A	2 x 2"	1 x 3/4"	55
EJB13-V1	825	605	320	405	628	M12	50 x 200	3 x 400A	2 x 2"	1 x 3/4"	95
EJB13-V2	825	605	320	405	628	M12	50 x 200	4" 4 x 400A	2 x 2"	1 x 3/4"	95

Enclosure

Marine grade aluminium alloy type AS10GY30
Toughened glass display
Stainless steel external earth stud
Stainless steel screws
Hinged door standard on EJB versions of
EJB8-11-12-13, (optional on other EJB versions)

Protection class: I

Cut-out equipment

"Sider" load-breaker, 50A to 400A,
3 or 4-poles visible breaking
(up to 800A on request)
Padlockable handle
Options: security key, auxiliary contacts
mechanical indicator

Cable entries

NPT or ISO entries and threads as requested
Brass, Nickel Plated Brass, or Stainless Steel cable
glands can be supplied (order separately) for either
armoured, or non-armoured cables.

Fixing

4 threaded holes on the back plate (see table)

Colour (standard)

● EJB-V*-00000 - Yellow offshore, RAL 1003

Colour options

● EJB-V*-B0000 - Grey, RAL 7035

● EJB-V*-C0000 - Black, RAL 9004

● EJB-V*-D0000 - Hammered Blue, RAL 5015

● EJB-V*-F0000 - Red, RAL 3001

● EJB-V*-G0000 - Blue, RAL 5010

● EJB-V*-J0000 - Green, RAL 6032

○ EJB-V*-M0000 - White, RAL 9010

For Accessories see page 132



EXL Conduit 148



Stopping Plugs 176



GUV Range 120

Related Products

Box Accessories

Spare Components for Control Panels & Enclosures

Components for Control Station

Complete Units for DTS control stations and boxes (SRC - EFDC Mod 1 & 2, XBL, XB, XBi, EJB)

Type	Function
BPN10	Push button Black NO+NC
BPR10	Push button Red NO+NC
BPV10	Push button green NO+NC
REA20	Reset button (customised for EJB ranges)
BCP30	Simple emergency stop push button NO+NC
BCP40	Push/Pull button Emergency Stop NO+NC
BCP50	Push button, unlockable by key N° 455
PRC10	Rotary switch 2x16A 0-1 2NO
PRC20	Rotary switch operated by key No 455 2x 16A 0-1 2NO
PRC30	Rotary switch 2x16A 1-2 NO+NC
PRC40	Rotary switch 2x16A 1-0-2 NO-0-NC
PRC50	Rotary switch 2x16A 0-1-2-0-NO-NO
PRC60	Rotary switch 4x16A 0-1 4NO
PRC70	Lockable rotary switch 3x25A 3NO
VAV10	Indicator lamp 230V - Green
VAR10	Indicator lamp 230V - Red
VAC10	Indicator lamp 230V - White
VAJ10	Indicator lamp 230V - Yellow
VAB10	Indicator lamp 230V - Blue

Options

Rotary Switch Options:

- Spring return (40A max for SRC)
- Configuration on request (eg : 3NO+1NF, 1 NO/Position...)

Push button options:

- Colours: Green, Red, Black, Amber, Blue
- Contacts (model 1 & EJB): Max 3 contacts according to request NO or NC
- Contacts (model 2): Max 6 contacts according to request NO or NC

Indicator Lamp Options:

Other voltages are available on request up to 400V

- LED

For all products:

Legends as requested

Spare Parts for the complete units (EFDC / SRC or EJB as specified)

Type	Function
PB01	Contacts NO+NC for push button switches
PR01	Rotary switch unit 2x16A 0-1 2NO
PR02	Rotary switch unit 2x16A 1-2 NO+NC
PR03	Rotary switch unit 2x16A 1-0-2 NO-0-NC
PR04	Rotary switch unit 2x16A 0-1-2-0-NO-NO
PR05	Rotary switch unit 4x16A 0-1 4NO
PR06	Rotary switch unit 3x25A 0-1 3NO
PR07	Rotary switch top
PR07V	Key operated switch top
BP02	Cap for push switch Green
BP03	Cap for push switch Red
BP04	Cap for push switch Black
BP05	Cap for mushroom push/pull switch
BP05V	Cap for key operated mushroom push switch
DE01	Indicator lamp lens Green
DE02	Indicator lamp lens Red
DE03	Indicator lamp lens White
DE04	Indicator lamp lens Amber
DE05	Indicator lamp lens Blue
DE10	Lamp holder for BA9S lamp

Options

Rotary Switch Options:

- Spring return (40A max for SRC)
- Configuration on request (eg : 3NO+1NF, 1 NO/Position...)

For all products:

- Legends as requested

Polyester / Aluminium Plug & Socket (Safe Disconnect)

DRX / DPX Range

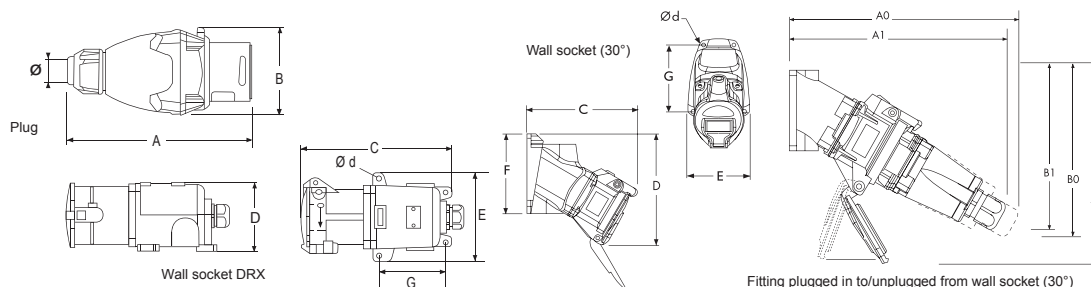

Socket Type	Plug Type	Poles	Nominal Current (A)	Power Supply (V)	Gland	Cable			Dimensions (mm)										Weight (kg)		
						A	B	Ø	C	D	E	F	G	Ød	AI	A0	BI	B0	Y	Socket	Plug
116E250	116E250	1P+N+PE	20	220/250	M20	125	58	8-13	127	131	68	90	78	4.5	204	215	162	168	180	0.3	0.16
216X24	216X24	2P	20	20 - 24	M20	125	58	8-13	127	131	68	90	78	4.5	204	215	162	168	180	0.3	0.16
316E250	316E250	3P+PE	20	130/230	M20	125	58	8-13	127	131	68	90	78	4.5	204	215	162	168	180	0.3	0.16
316E415	316E415	3P+PE	20	380/440	M20	125	58	8-13	127	131	68	90	78	4.5	204	215	162	168	180	0.3	0.16
416E415	416E415	3P+N+PE	20	380/440	M20	125	58	8-13	127	131	68	90	78	4.5	204	215	162	168	180	0.3	0.16
132E250	132E250	1P+N+PE	32	220/250	M25	145	68	13-19	138	132	84	107	70	6	214	229	162	171	200	0.46	0.24
232X24	232X24	2P	32	20 - 24	M25	145	68	13-19	138	132	84	107	70	6	214	229	162	171	200	0.46	0.24
332E250	332E250	3P+PE	32	150/230	M25	145	68	13-19	138	132	84	107	70	6	214	229	162	171	200	0.46	0.24
332E415	332E415	3P+PE	32	380/440	M25	145	68	13-19	138	132	84	107	70	6	214	229	162	171	200	0.46	0.24
432E415	432E415	3P+N+PE	32	380/440	M25	145	68	13-19	138	132	84	107	70	6	214	229	162	171	200	0.46	0.24
163E250	163E250	1P+N+PE	63	220/250	M32	152	83	17-25	165	162	89	122	88	6.5	233	259	184	199	236	0.64	0.42
263X24	263X24	2P	63	20 - 24	M32	152	83	17-25	165	162	89	122	88	6.5	233	259	184	199	236	0.64	0.42
363E415	363E415	3P+PE	63	380/440	M32	152	83	17-25	165	162	89	122	88	6.5	233	259	184	199	236	0.64	0.42
463E415	463E415	3P+N+PE	63	380/440	M32	152	83	17-25	165	162	89	122	88	6.5	233	259	184	199	236	0.64	0.42

Socket Type	Plug Type	Poles	Nominal Current (A)	Power Supply (V)	Cable Gland	Cable			Dimensions (mm)										Weight (kg)		
						A	B	Ø	C	D	E	F	G	Ød	AI	A0	BI	B0	Y	Socket	Plug
3125E415	3125E415	3P+T	125	380/440	M50	220	146	27-41	378	175	221	-	174	9.5	513	-	175	-	-	8.0	2.6
4125E415	4125E415	3P+N+T	125	380/440	M50	220	146	27-41	378	175	221	-	174	9.5	513	-	175	-	-	8.0	2.6

Approved to: IEC 60079-0, 60079-1, 60079-7, 61241-0, 61241-1 60309-1, 60309-4

EC TYPE Examination Certificate: under new directive 94/9/EC

20A versions: LCIE 99 ATEX 6027X, IECEx LCI09.005X, ≤ -40°C to ≤ +60°C T5 T90°C, ≤ -40°C to ≤ +40°C T6 T70°C

32A versions: LCIE 05 ATEX 6149, IECEx LCI09.0006, ≤ -40°C to ≤ +60°C T4 T98°C, ≤ -40°C to ≤ +40°C T6 T78°C

63A versions: LCIE 05 ATEX 6150, IECEx LCI09.0007, ≤ -40°C to ≤ +60°C T4 T107°C, ≤ -40°C to ≤ +40°C T5 T87°C

125A versions: LCIE 04 ATEX 6038, IECEx LCI09.0015, ≤ -40°C to ≤ +60°C T5 T90°C, ≤ -40°C to ≤ +50°C T6 T80°C













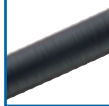

















ATEX II 2 G / D, IP6x Exd e II C tDA21 Ingress protection: IP66/67 (PBT), IP65 (aluminium)













Conduit & Glands



Conduit Fittings - Selection Guide

		For use with Nylon Conduits			For use with Liquid Tight Conduits							
												
		Nylon Conduits Page 138	Metallic Fittings Page 140	Nylon Fittings Page 142	Liquid Tight Conduits Page 148	Group 1 Glands Page 152	Group 1 90° Elbow Glands Page 154	Group 1 Universal Fittings Page 155	Group 1 Universal Swivel Fittings Page 157	Group II Glands Page 158		
Dust Group	Gas		<input checked="" type="checkbox"/>	<input checked="" type="checkbox"/>	<input checked="" type="checkbox"/>	<input checked="" type="checkbox"/>	<input checked="" type="checkbox"/>	<input checked="" type="checkbox"/>	<input checked="" type="checkbox"/>	<input checked="" type="checkbox"/>		
			<input checked="" type="checkbox"/>	<input checked="" type="checkbox"/>	<input checked="" type="checkbox"/>	<input checked="" type="checkbox"/>	<input checked="" type="checkbox"/>	<input checked="" type="checkbox"/>	<input checked="" type="checkbox"/>	<input checked="" type="checkbox"/>	<input checked="" type="checkbox"/>	
	Protection Type											
		Intertek										
							<input checked="" type="checkbox"/>	<input checked="" type="checkbox"/>	<input checked="" type="checkbox"/>	<input checked="" type="checkbox"/>		
		UL										
			<input checked="" type="checkbox"/>	<input checked="" type="checkbox"/>			<input checked="" type="checkbox"/>	<input checked="" type="checkbox"/>	<input checked="" type="checkbox"/>	<input checked="" type="checkbox"/>		
			<input checked="" type="checkbox"/>	<input checked="" type="checkbox"/>			<input checked="" type="checkbox"/>	<input checked="" type="checkbox"/>	<input checked="" type="checkbox"/>	<input checked="" type="checkbox"/>		
			<input checked="" type="checkbox"/>	<input checked="" type="checkbox"/>								
												
							<input checked="" type="checkbox"/>	<input checked="" type="checkbox"/>	<input checked="" type="checkbox"/>	<input checked="" type="checkbox"/>	<input checked="" type="checkbox"/>	
			<input checked="" type="checkbox"/>	<input checked="" type="checkbox"/>	<input checked="" type="checkbox"/>		<input checked="" type="checkbox"/>	<input checked="" type="checkbox"/>	<input checked="" type="checkbox"/>	<input checked="" type="checkbox"/>		
	Zones		<input checked="" type="checkbox"/>	<input checked="" type="checkbox"/>	<input checked="" type="checkbox"/>		<input checked="" type="checkbox"/>	<input checked="" type="checkbox"/>	<input checked="" type="checkbox"/>	<input checked="" type="checkbox"/>	<input checked="" type="checkbox"/>	
			<input checked="" type="checkbox"/>	<input checked="" type="checkbox"/>	<input checked="" type="checkbox"/>		<input checked="" type="checkbox"/>	<input checked="" type="checkbox"/>	<input checked="" type="checkbox"/>	<input checked="" type="checkbox"/>		
			<input checked="" type="checkbox"/>	<input checked="" type="checkbox"/>	<input checked="" type="checkbox"/>		<input checked="" type="checkbox"/>	<input checked="" type="checkbox"/>	<input checked="" type="checkbox"/>	<input checked="" type="checkbox"/>	<input checked="" type="checkbox"/>	
			<input checked="" type="checkbox"/>	<input checked="" type="checkbox"/>	<input checked="" type="checkbox"/>		<input checked="" type="checkbox"/>	<input checked="" type="checkbox"/>	<input checked="" type="checkbox"/>	<input checked="" type="checkbox"/>	<input checked="" type="checkbox"/>	
			<input checked="" type="checkbox"/>	<input checked="" type="checkbox"/>	<input checked="" type="checkbox"/>		<input checked="" type="checkbox"/>	<input checked="" type="checkbox"/>	<input checked="" type="checkbox"/>	<input checked="" type="checkbox"/>	<input checked="" type="checkbox"/>	
			<input checked="" type="checkbox"/>	<input checked="" type="checkbox"/>	<input checked="" type="checkbox"/>		<input checked="" type="checkbox"/>	<input checked="" type="checkbox"/>	<input checked="" type="checkbox"/>	<input checked="" type="checkbox"/>	<input checked="" type="checkbox"/>	
		CLASS								<input checked="" type="checkbox"/>	<input checked="" type="checkbox"/>	
										<input checked="" type="checkbox"/>	<input checked="" type="checkbox"/>	
						<input checked="" type="checkbox"/>	<input checked="" type="checkbox"/>	<input checked="" type="checkbox"/>	<input checked="" type="checkbox"/>			
						<input checked="" type="checkbox"/>	<input checked="" type="checkbox"/>	<input checked="" type="checkbox"/>	<input checked="" type="checkbox"/>			
						<input checked="" type="checkbox"/>	<input checked="" type="checkbox"/>	<input checked="" type="checkbox"/>	<input checked="" type="checkbox"/>			
						<input checked="" type="checkbox"/>	<input checked="" type="checkbox"/>	<input checked="" type="checkbox"/>	<input checked="" type="checkbox"/>			

Conduit Fittings - Selection Guide

 XP Flex Page 160	 Ex d Cable Glands Page 162	 Ex d Cable Glands Page 164	 Ex e Cable Glands Page 166	 Nylon Cable Glands Page 168	 Thread Convertors Page 170	 Standard Stopping Plugs Page 174	 Tamperproof Stopping Plugs Page 174	 Hex Head Stopping Plugs Page 176	 Dome Head Stopping Plugs Page 176	 Nylon Stopping Plugs Page 176
	●	●	●	●	●	●	●	●	●	●
	●	●	●	●	●	●	●	●	●	●
					●	●	●			
●					●	●	●			
●										
					●	●	●	●	●	
					●	●	●	●	●	
	●	●	●	●	●	●	●	●	●	●
	●	●			●	●	●			
	●	●	●	●				●	●	●
	●	●	●	●	●	●	●	●	●	●
	●	●	●	●	●	●	●	●	●	●
	●	●	●	●	●	●	●	●	●	●
	●	●	●	●	●	●	●	●	●	●
	●	●	●	●	●	●	●	●	●	●
	●	●	●	●	●	●	●	●	●	●
●					●	●	●			
●										
●					●	●	●			

Non-metallic Nylon Conduit

Technical Specifications

EXB Anti-Static Conduit compatible with EXPQM / EXPQA Fittings



Anti-Static Nylon 12 (Black)

Type	Conduit Size (mm)		Outside Diameter (mm)	Coil Lengths (m)
	Metric	NW		
EXB03*	16	12	15.8	10/30/50
EXB04*	21	17	21.2	10/30/50
EXB05*	28	23	28.5	10/30/50
EXB06*	34	29	34.4	10/30/50
EXB07*	42	36	42.4	10/30/50
EXB08*	54	48	54.5	10/30/50
EXB09*	63	56	67.2	10/30/50
EXB10*	80	70	80	10/30/50

*Add coil length to complete part number, e.g. 10 metres = EXB0510

EC TYPE Examination Certificate:

ATEX: Baseefa 08 ATEX 0003X
 IECEx: IECEx BAS08.0001X
 GOST R: POCC GB.ГБ05.Б03850
 INMETRO: TÜV 11.0091

Ex e IIC Gb
 Ex tb IIIC Db
Temperature: -20°C to 80°C
 RTI 110°C to EN60079-0

Special Characteristics

EXB: Surface resistivity <10⁶Ω

EXBB Overbraided Conduit compatible with EXBQM / EXBQA Fittings



Anti-Static Nylon 12 (Stainless Steel)

Type	Conduit Size (mm)		Outside Diameter (mm)	Coil Lengths (m)
	Metric	NW		
EXBB03*	16	12	12	50
EXBB04*	21	17	17	50
EXBB05*	28	23	23	50
EXBB06*	34	29	27	50
EXBB07*	42	36	36	30
EXBB08*	54	48	48	30

*Add coil length to complete part number, e.g. 10 metres = EXBB0510

EC TYPE Examination Certificate:

ATEX: Baseefa 08 ATEX 0003X
 IECEx: IECEx BAS08.0001X
 GOST R: POCC GB.ГБ05.Б03850
 INMETRO: TÜV 11.0091

Ex e IIC Gb
 Ex tb IIIC Db
Temperature: -20°C to 80°C
 RTI 110°C to EN60079-0

Special Characteristics

EXBB: Screening level 60dB at 1MHz

Related Products



EXPQM Fitting 140



EXBQM Fitting 140

Non-Metallic Nylon Conduit - EXB / EXBB / XESX Range



Technical Specifications

XESX Anti-Static Nylon Multi-Layer Conduit compatible with EXPQM / EXBQA Fittings



Anti-Static Nylon 12 (Black) Type	Conduit Size (mm)		Coil Lengths (m)	Outside Diameter (mm)
	Metric	NW		
XESX02*	12	10	50	12.8
XESX03*	16	12	50	15.6
XESX04*	21	17	50	21
XESX05*	28	23	50	28.5
XESX06*	34	29	50	34.4
XESX07*	42	36	30	42.4
XESX08*	54	48	30	54.4

*Add coil length to complete part number, e.g. 10 metres = XESX0510

EC TYPE Examination Certificate:
ATEX: Baseefa 08 ATEX 0003X
IECEX: IECEX BAS08.0001X

Ex e IIC Gb
Ex tb IIIC Db
Temperature: -40°C to 85°C

RTI 110°C to EN60079-0
Special Characteristics
XESX: Surface resistivity <10⁶Ω



EXPQM Fitting 140



EXBQM Fitting 140

Related Products

XESX Anti-Static Conduit compatible with all Nylon Fittings

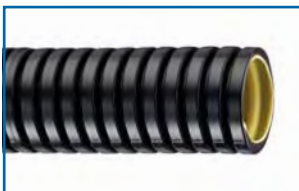

Anti-Static Nylon 12 (Black) Type	Conduit Size (mm)		Coil Lengths (m)
	Metric	NW	
XESXT-10BY.50	12	10	50
XESXT-12BY.50	16	12	50
XESXG-17BY.50	21	17	50
XESXG-23BY.50	28	23	50
XESXG-29BY.50	34	29	50
XESXG-36BY.30	42	36	30
XESXG-48BY.30	54	48	30

EC TYPE Examination Certificate:
ATEX SEV 05 ATEX0105

Ex eb IIC Gb
Ex tb IIIC Db

Temperature: -40°C to 85°C

Special Characteristics:
XESX: Surface resistivity <10⁶Ω



NENV Fitting 142



NENZ Fitting 142



NEBV Fitting 144



NEWV Fitting 144



NEAV Fitting 144

Related Products



EXBQM / EXPQA Range Nylon conduit fittings



Approvals / Characteristics



Features

- Manufactured in Nickel Plated Brass
- Approved for use in Ex e applications for Zones 1, 2, 21 & 22

Certification & Standards

EC TYPE Examination Certificate:
 ATEX: Baseefa 08 ATEX 0003X
 IECEx: IECEx BAS08.0001X
 GOST R: POCC GB.ГБ05.В03850
 INMETRO: TÜV 11.0091
 Ex e IIC Gb
 Ex tb IIC Db
Temperature: -40°C to 85°C

Non-Metallic Nylon Conduit Fittings - EXPQM / EXBQA Range

EXPQM Straight Male Conduit Fitting for EXB / XESX Nylon Conduit

Technical Specifications



Nickel Plated Brass

Type - Metric

Type - Metric	Conduit Size (mm)		Thread Size
	Metric	NW	Metric (mm)
EXPQM0203	12	10	16
EXPQM0303	16	12	16
EXPQM0304	16	12	20
EXPQM0404	20	17	20
EXPQM0505	28	23	25
EXPQM0606	34	29	32
EXPQM0707	42	36	40
EXPQM0808	54	48	50
EXPQM0909	63	56	63
EXPQM1010	80	70	75

Nickel Plated Brass

Type - NPT

Type - NPT	Conduit Size (mm)		Thread Size
	Metric	NW	NPT (inch)
EXPQA0304	16	12	1/2
EXPQA0404	20	17	1/2
EXPQA0505	28	23	3/4
EXPQA0606	34	29	1
EXPQA0707	42	36	1 1/4
EXPQA0808	54	48	1 1/2
EXPQA0909	63	56	2
EXPQA1010	80	70	2 1/2

EXBQM Straight Male Conduit Fitting for EXBB Braided Conduit



Nickel Plated Brass

Type - Metric

Type - Metric	Conduit Size (mm)		Thread Size
	Metric	NW	Metric (mm)
EXBQM0304	16	12	20
EXBQM0404	20	17	20
EXBQM0505	28	23	25
EXBQM0606	34	29	32
EXBQM0707	42	36	40
EXBQM0808	54	48	50

Nickel Plated Brass

Type - NPT

Type - NPT	Conduit Size (mm)		Thread Size
	Metric	NW	NPT (inch)
EXBQA0304	16	12	1/2
EXBQA0404	20	17	1/2
EXBQA0505	28	23	3/4
EXBQA0606	34	29	1
EXBQA0707	42	36	1 1/4
EXBQA0808	54	48	1 1/2

For Accessories see page 178-79



Locknuts 178

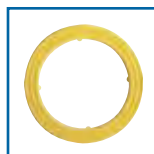

Sealing Washers 178



EXB Range 138

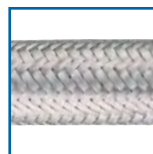

EXBB Range 138



XESX Multi-Layer 139 Range

Related Products



Nylon Conduit Fittings

Nylon conduit fittings for XESX conduit (⚡ only)



Approvals / Characteristics



Features

- Manufactured in modified Nylon 12 with Nickel Plated Brass threads
- Approved for use in Ex e applications for Zones 1, 2, 21 & 22

Certification & Standards

EC TYPE Examination Certificate:
 ATEX: SEV 05 ATEX 0105
 Ex eb IIC
 Ex tb IIC
 Temperature: -20°C to 85°C

Non-Metallic Nylon Fittings for XESX Conduit (only)

NENV Straight Male Conduit Fitting

Technical Specifications



Type - Metric	Conduit Size (mm)		Metric Thread
	Metric	NW	Size (mm)
NENV-M120-10	12	10	12
NENV-M160-10	12	10	16
NENV-M162-10	16	12	16
NENV-M202-10	16	12	20
NENV-M207-10	20	17	20
NENV-M257-11	20	17	25
NENV-M253-11	25	23	25
NENV-M323-13	25	23	32
NENV-M329-13	32	29	32
NENV-M409-13	32	29	40
NENV-M406-13	40	36	40
NENV-M506-14	40	36	50
NENV-M508-14	50	48	50
NENV-M638-114	50	48	63

NENZ Straight Male Conduit Fitting with Strain Relief



Type - Metric	Conduit Size (mm)		Metric Thread
	Metric	NW	Size (mm)
NENZ-M120S/P	12	10	12
NENZ-M160S/P	12	10	16
NENZ-M202S/P	12	10	20
NENZ-M207S/P	16	12	20
NENZ-M257S/P	20	17	20
NENZ-M323S/P	20	17	25
NENZ-M409S/P	25	23	32
NENZ-M506S/P	32	29	40
NENZ-M508S/P	40	36	50
NENZ-M638S/P	50	48	63

*Available with various clamping ranges



Locknuts 178



XESX Range 139

Related Products

Nylon Conduit Fittings for XESX Conduit (Ex only)

Technical Specifications

NEBV 90° Curved Elbow



Type - Metric	Conduit Size (mm)		Metric Thread Size (mm)
	Metric	NW	
NEBV-M207-10	20	17	20
NEBV-M257-11	20	17	25
NEBV-M253-11	25	23	25
NEBV-M323-13	25	23	32
NEBV-M329-13	32	29	32
NEBV-M409-13	32	29	40
NEBV-M406-13	40	36	40
NEBV-M506-14	40	36	50
NEBV-M508-14	50	48	50
NEBV-M638-14	50	48	63

NEWV 90° Elbow



Type - Metric	Conduit Size (mm)		Metric Thread Size (mm)
	Metric	NW	
NEWV-M120-10*	12	10	12
NEWV-M160-10*	12	10	16
NEWV-M162-10*	16	12	16
NEWV-M202-10*	16	12	20

NEAV 45° Elbow



Type - Metric	Conduit Size (mm)		Metric Thread Size (mm)
	Metric	NW	
NEAV-M120-10	20	17	20
NEAV-M162-10	20	17	25
NEAV-M207-10	25	23	25
NEAV-M257-11	25	23	32
NEAV-M253-11	32	29	32
NEAV-M323-13	32	29	40
NEAV-M329-13	40	36	40
NEAV-M409-13	40	36	50
NEAV-M406-13	50	48	50
NEAV-M506-14	50	48	63
NEAV-M508-14	50	48	50
NEAV-M638-14	50	48	63

Non-Metallic Nylon Fittings for XESX Conduit (Ex only)



Technical Specifications

BESGR Splice Connector



Type - Metric	Conduit Size (mm)	
	Metric	NW
BESGR-1212	16	12
BESGR-1212	20	17
BESGR-1212	25	23
BESGR-1212	32	29
BESGR-1212	40	36
BESGR-1212	50	48

BEYR Y Piece



Type - Metric	Conduit Size (mm)		2 x Conduit Size (mm)	
	Metric	NW	Metric	NW
BEYR-121010	16	12	12	10
BEYR-171212	20	17	16	12
BEYR-231717	25	23	20	17
BEYR-292323	32	29	25	23
BEYR-362929	40	36	32	29
BEYR-483636	50	48	40	36

BETR Tee Piece



Type - Metric	Conduit Size (mm)	
	Metric	NW
BETR-101010	12	10
BETR-121212	16	12
BETR-171717	20	17
BETR-232323	25	23
BETR-292929	32	32
BETR-363636	40	40
BETR-363636	50	50

For Accessories see page 178-79



Locknuts 178

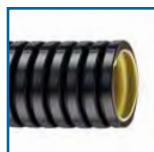

XESX Range 139

Related Products

Nylon Conduit Fittings for XESX Conduit (only)

Technical Specifications

BEAVR Reducer



Type - Metric	Conduit Size (mm)	
	Metric	NW
BEAVR-12/10	16	12
BEAVR-17/12	20	17
BEAVR-23/17	25	23
BEAVR-29/23	32	29
BEAVR-36/29	40	36
BEAVR-48/36	50	48

NEIR Reducer Female Thread Adapter - Straight



Type - Metric	Conduit Size (mm)	
	Metric	NW
NEIR-M120	12	10
NEIR-M160	16	10
NEIR-M162	16	12
NEIR-M207	20	17
NEIR-M253	25	23
NEIR-M329	32	29
NEIR-M406	40	36
NEIR-M508	50	48
NEIR-M638	63	48

BENR-REM Corrugated Conduit to Rigid Metal Pipe Connection



Type - Metric	Conduit Size (mm)		External Dimensions (mm)
	Metric	NW	
BENR-REM162-24	16	12	54
BENR-REM207-28	20	17	65
BENR-REM253-32	25	23	71
BENR-REM329-44	32	29	71
BENR-REM406-50	40	36	90
BENR-REM508-65	50	48	90

Non-Metallic Nylon Fittings for XESX Conduit (Ex only)



Technical Specifications

HEAK EMC Connector with Conical Shielding Braid Clamp compatible with NENV / NENZ / NEBV / NEWV / NEAV



Nickel Plated Brass

Conduit Size (mm)

Type - Metric

Metric (Fits to thread)

NW

HEAK-M32/25-13

32 - 25

23

HEAK-M40/32-13

40 - 32

29

HEAK-M50/40-14

50 - 40

36

HEAK-M63/63-14

63 - 63

48

BEH Conduit Clip

Accessories



Conduit Size (mm)

Type - Metric

Metric

NW

BEH-10-0

12

10

BEH-12-0

16

12

BEH-17-0

20

17

BEH-23-0

25

23

BEH-29-0

32

29

BEH-36-0

40

36

BEH-48-0

50

48

For Accessories see page 178-79



Locknuts 178

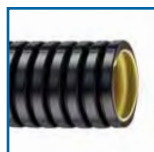

XESX Range 139

Related Products

Liquid Tight Conduit - Galvanised Steel Core

Technical Specifications

General Oil Resistant - Galvanised Steel Core with a general purpose oil resistant coating

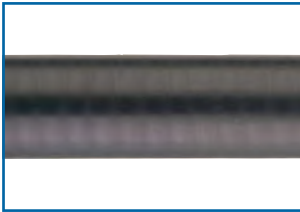

General Oil Resistant (Black) Type	Conduit Size Metric (mm)	US Trade Size (inch)	Inside Diameter (mm)	Coil Lengths (m)
EXLB03*	16	3/8	12.5	10/30
EXLB04*	20	1/2	16.0	10/30
EXLB05*	25	3/4	21.0	10/30
EXLB06*	32	1	26.4	10/20
EXLB07*	40	1 1/4	35.3	10/20
EXLB08*	50	1 1/2	40.4	10/20
EXLB09*	63	2	51.6	10/20

*Add coil length to complete part number, e.g. 10 metres = EXLB0510

Certification Standard: IEC 61386
Static Temp: -25°C to +105°C
Flexing Temp: -5°C to +105°C

Special Characteristics
 Flame retardant PVC covering

Flame Propagation
 Flame dies in less than 30 seconds after ignition source is removed

Low Fire Hazard - Galvanised Steel Core with a LFH coating



Low Fire Hazard (Black) Type	Conduit Size Metric (mm)	US Trade Size (inch)	Inside Diameter (mm)	Coil Lengths (m)
EXLT03*	16	3/8	12.5	10/30
EXLT04*	20	1/2	16.0	10/30
EXLT05*	25	3/4	21.0	10/30
EXLT06*	32	1	26.4	10/20
EXLT07*	40	1 1/4	35.3	10/20
EXLT08*	50	1 1/2	40.4	10/20
EXLT09*	63	2	51.6	10/20

*Add coil length to complete part number, e.g. 10 metres = EXLT0510

Certification Standard: IEC 61386
 LUL Fully Compliant (E1042A6)
 MOD to NES 518: Issue 3 DEF STAN 61-12 (Part 31) Issue 1

Static Temp: -25°C to +90°C
Flexing Temp: -5°C to +90°C
Special Characteristics
 Limited Fire Hazard, zero halogen (BS6425 Pt 1)

Flame Propagation
 Flame dies in less than 30 seconds after ignition source is removed

Low Fire Hazard with EMC Protection - Galvanised Steel Core with a galvanised steel EMC shield and LFH Covering



Low Fire Hazard with EMC (Black) Type	Conduit Size Metric (mm)	US Trade Size (inch)	Inside Diameter (mm)	Coil Lengths (m)
EXBBT03*	16	3/8	12.5	10/30
EXBBT04*	20	1/2	16.0	10/30
EXBBT05*	25	3/4	21.0	10/30
EXBBT06*	32	1	26.4	10/20
EXBBT07*	40	1 1/4	35.3	10/20
EXBBT08*	50	1 1/2	40.4	10/20
EXBBT09*	63	2	51.6	10/20

*Add coil length to complete part number, e.g. 10 metres = EXBBT0510

Certification Standard: IEC 61386
 MOD to NES 518: Issue 3 DEF STAN 61-12 (Part 31) Issue 1

Static Temp: -25°C to +90°C
Flexing Temp: -5°C to +90°C

Special Characteristics
 Limited Fire Hazard covering
 EMC Screening level: 60db at 1MHz Braided



Technical Specifications

High Temperature - Galvanised Steel Core with a high temperature resistant coating



High Temperature (Black) Type	Conduit Size Metric (mm)	US Trade Size (inch)	Inside Diameter (mm)	Coil Lengths (inch)
EXLH03*	16	3/8	12.5	10/30
EXLH04*	20	1/2	16.0	10/30
EXLH05*	25	3/4	21.0	10/30
EXLH06*	32	1	26.4	10/20
EXLH07*	40	1 1/4	35.3	10/20
EXLH08*	50	1 1/2	40.4	10/20
EXLH09*	63	2	51.6	10/20

*Add coil length to complete part number, e.g. 10 metres = EXLH0510

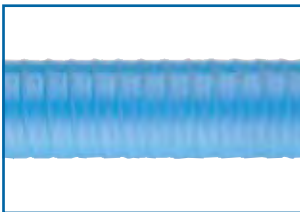

High Temperature (Blue) Type	Conduit Size Metric (mm)	US Trade Size (inch)	Inside Diameter (mm)	Coil Lengths (inch)
EXLLH03*	16	3/8	12.5	10/30
EXLLH04*	20	1/2	16.0	10/30
EXLLH05*	25	3/4	21.0	10/30
EXLLH06*	32	1	26.4	10/20
EXLLH07*	40	1 1/4	35.3	10/20
EXLLH08*	50	1 1/2	40.4	10/20
EXLLH09*	63	2	51.6	10/20

*Add coil length to complete part number, e.g. 10 metres = EXLLH0510

Certification Standard: IEC 61386
Static Temp: -50°C to +130°C
Flexing Temp: -5°C to +90°C

Special Characteristics
 Flame resistance: UL94 V2
 Chemical and oil resistant

Flame Propagation
 Flame dies in less than 30 seconds after ignition source is removed

High Temperature Highly Flexible - Galvanised Steel Core with a high temperature, highly flexible coating



High Temperature, Highly Flexible (Blue) Type	Conduit Size Metric (mm)	US Trade Size (inch)	Inside Diameter (mm)	Coil Lengths (inch)
EXLHC03*	16	3/8	12.5	10/30
EXLHC04*	20	1/2	16.0	10/30
EXLHC05*	25	3/4	21.0	10/30
EXLHC06*	32	1	26.4	10/20
EXLHC07*	40	1 1/4	35.3	10/20
EXLHC08*	50	1 1/2	40.4	10/20
EXLHC09*	63	2	51.6	10/20

*Add coil length to complete part number, e.g. 10 metres = EXLHC0510

Certification Standard: IEC 61386
Static Temp: -65°C to +150°C
Flexing Temp: -45°C to +135°C

Special Characteristics
 High Flexibility
 High Temperature

Flame Propagation
 Flame dies in less than 30 seconds after ignition source is removed



Group I Gland 152



Group II Gland 158

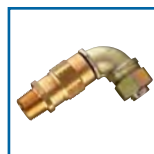

90° Elbow Gland 144

Related Products

Liquid Tight Conduit - Stainless Steel Core

Technical Specifications

General Oil Resistant - Stainless Steel 316 Core with a general purpose oil resistant coating



General Oil Resistant (Black) Type	Conduit Size Metric (mm)	US Trade Size (inch)	Inside Diameter (mm)	Coil Lengths (m)
EXSB03*	16	3/8	12.5	10/30
EXSB04*	20	1/2	16.0	10/30
EXSB05*	25	3/4	21.0	10/30
EXSB06*	32	1	26.4	10/20
EXSB07*	40	1 1/4	35.3	10/20
EXSB08*	50	1 1/2	40.4	10/20
EXSB09*	63	2	51.6	10/20

*Add coil length to complete part number, e.g. 10 metres = EXSB0510

Certification Standard: IEC 61386
Static Temp: -25°C to +105°C
Flexing Temp: -5°C to +105°C

Special Characteristics
 Flame retardant PVC covering

Flame Propagation
 Flame dies in less than 30 seconds after ignition source is removed

Low Fire Hazard - Stainless Steel Core with a LFH coating



Low Fire Hazard (Black) Type	Conduit Size Metric (mm)	US Trade Size (inch)	Inside Diameter (mm)	Coil Lengths (m)
EXST03*	16	3/8	12.5	10/30
EXST04*	20	1/2	16.0	10/30
EXST05*	25	3/4	21.0	10/30
EXST06*	32	1	26.4	10/20
EXST07*	40	1 1/4	35.3	10/20
EXST08*	50	1 1/2	40.4	10/20
EXST09*	63	2	51.6	10/20

*Add coil length to complete part number, e.g. 10 metres = EXLT0510

Certification Standard: IEC 61386
 LUL Fully Compliant (E1042A6)
 MOD to NES 518: Issue 3 DEF STAN 61-12 (Part 31) Issue 1

Static Temp: -25°C to +90°C
Flexing Temp: -5°C to +90°C
Special Characteristics
 Limited Fire Hazard, zero halogen (BS6425 Pt 1)

Flame Propagation
 Flame dies in less than 30 seconds after ignition source is removed

Low Fire Hazard with EMC Protection - Stainless Steel Core with a galvanised steel EMC shield and LFH Covering



Low Fire Hazard with EMC (Black) Type	Conduit Size Metric (mm)	US Trade Size (inch)	Inside Diameter (mm)	Coil Lengths (m)
EXSBBT03*	16	3/8	12.5	10/30
EXSBBT04*	20	1/2	16.0	10/30
EXSBBT05*	25	3/4	21.0	10/30
EXSBBT06*	32	1	26.4	10/20
EXSBBT07*	40	1 1/4	35.3	10/20
EXSBBT08*	50	1 1/2	40.4	10/20
EXSBBT09*	63	2	51.6	10/20

*Add coil length to complete part number, e.g. 10 metres = EXBBT0510

Certification Standard: IEC 61386
 MOD to NES 518: Issue 3 DEF STAN 61-12 (Part 31) Issue 1

Static Temp: -25°C to +90°C
Flexing Temp: -5°C to +90°C

Special Characteristics
 Limited Fire Hazard covering
 EMC Screening level: 60db at 1MHz Braided



Technical Specifications

High Temperature - Stainless Steel Core with a high temperature resistant coating



High Temperature (Black) Type	Conduit Size Metric (mm)	US Trade Size (inch)	Inside Diameter (mm)	Coil Lengths (inch)
EXSH03*	16	3/8	12.5	10/30
EXSH04*	20	1/2	16.0	10/30
EXSH05*	25	3/4	21.0	10/30
EXSH06*	32	1	26.4	10/20
EXSH07*	40	1 1/4	35.3	10/20
EXSH08*	50	1 1/2	40.4	10/20
EXSH09*	63	2	51.6	10/20

*Add coil length to complete part number, e.g. 10 metres = EXLH0510

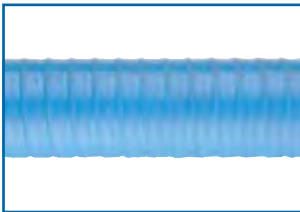

High Temperature (Blue) Type	Conduit Size Metric (mm)	US Trade Size (inch)	Inside Diameter (mm)	Coil Lengths (inch)
EXSLH03*	16	3/8	12.5	10/30
EXSLH04*	20	1/2	16.0	10/30
EXSLH05*	25	3/4	21.0	10/30
EXSLH06*	32	1	26.4	10/20
EXSLH07*	40	1 1/4	35.3	10/20
EXSLH08*	50	1 1/2	40.4	10/20
EXSLH09*	63	2	51.6	10/20

*Add coil length to complete part number, e.g. 10 metres = EXLLH0510

Certification Standard: IEC 61386
Static Temp: -50°C to +130°C
Flexing Temp: -5°C to +130°C

Special Characteristics
 Flame resistance: UL94 V2
 Chemical and oil resistant

Flame Propagation
 Flame dies in less than 30 seconds after ignition source is removed

High Temperature Highly Flexible - Stainless Steel Core with a high temperature, highly flexible coating



High Temperature, Highly Flexible (Blue) Type	Conduit Size Metric (mm)	US Trade Size (inch)	Inside Diameter (mm)	Coil Lengths (inch)
EXSHC03*	16	3/8	12.5	10/30
EXSHC04*	20	1/2	16.0	10/30
EXSHC05*	25	3/4	21.0	10/30
EXSHC06*	32	1	26.4	10/20
EXSHC07*	40	1 1/4	35.3	10/20
EXSHC08*	50	1 1/2	40.4	10/20
EXSHC09*	63	2	51.6	10/20

*Add coil length to complete part number, e.g. 10 metres = EXLHC0510

Certification Standard: IEC 61386
Static Temp: -65°C to +150°C
Flexing Temp: -45°C to +135°C

Special Characteristics
 High Flexibility
 High Temperature

Flame Propagation
 Flame dies in less than 30 seconds after ignition source is removed



Group I Gland 152



Group II Gland 158



90° Elbow Gland 144

Related Products



G1 Glands

Liquid tight hazardous area flameproof glands



Approvals / Characteristics



Features

- Constructed from either Brass or Stainless Steel with an epoxy resin barrier the Group I Flameproof Gland is a high specification product, ideal for all hazardous area applications

Certification & Standards

EC TYPE Examination Certificate:
 ATEX: Sira 09 ATEX 1231X
 IECEX: IECEX SIR09.0103X
 CSA: CSA File No: 2310045
 GOST R: POCC GB.ГБ05.В03850
 INMETRO: TÜV 11.0339X
 Ex de I Mb
 Ex de IIC Gb
 Ex tb IIC Db
 Class I Div 2 ABCD
 Class II Div 1 EFG
Temperature: -60°C to +130°C

Liquid Tight Hazardous Area Flameproof G1 Glands

ATEX Flameproof G1 Gland

Technical Specifications



Nickel Plated Type - Metric	Conduit Size Metric (mm)	Thread Size Metric (mm)
HAMM0304G1	16	20
HAMM0404G1	20	20
HAMM0505G1	25	25
HAMM0606G1	32	32
HAMM0707G1	40	40
HAMM0808G1	50	50
HAMM0909G1	63	63

Brass Type - Metric	Conduit Size Metric (mm)	Thread Size Metric (mm)
HAM0304G1	16	20
HAM0404G1	20	20
HAM0505G1	25	25
HAM0606G1	32	32
HAM0707G1	40	40
HAM0808G1	50	50
HAM0909G1	63	63

Stainless Steel Type - Metric	Conduit Size Metric (mm)	Thread Size Metric (mm)
HAMS0304G1	16	20
HAMS0404G1	20	20
HAMS0505G1	25	25
HAMS0606G1	32	32
HAMS0707G1	40	40
HAMS0808G1	50	50
HAMS0909G1	63	63

Nickel Plated Type - NPT	Conduit Size Metric (mm)	Thread Size NPT (inch)
HAAM0304G1	16	1/2
HAAM0404G1	20	1/2
HAAM0505G1	25	3/4
HAAM0606G1	32	1
HAAM0707G1	40	1 1/4
HAAM0808G1	50	1 1/2
HAAM0909G1	63	2

Brass Type - NPT	Conduit Size Metric (mm)	Thread Size NPT (inch)
HAA0304G1	16	1/2
HAA0404G1	20	1/2
HAA0505G1	25	3/4
HAA0606G1	32	1
HAA0707G1	40	1 1/4
HAA0808G1	50	1 1/2
HAA0909G1	63	2

Stainless Steel Type - NPT	Conduit Size Metric (mm)	Thread Size NPT (inch)
HAAS0304G1	16	1/2
HAAS0404G1	20	1/2
HAAS0505G1	25	3/4
HAAS0606G1	32	1
HAAS0707G1	40	1 1/4
HAAS0808G1	50	1 1/2
HAAS0909G1	63	2

See page 148-153 for suitable conduits

For Accessories see page 178-79



General Oil Resistant 148

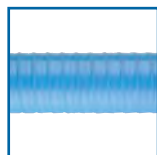

High Temperature Conduit 150



Low Fire Flexible Conduit 150

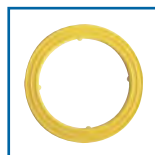

Sealing Washers 178

Related Products

Liquid tight hazardous area flameproof G1 glands

Technical Specifications

ATEX Flameproof 90° Elbow Gland

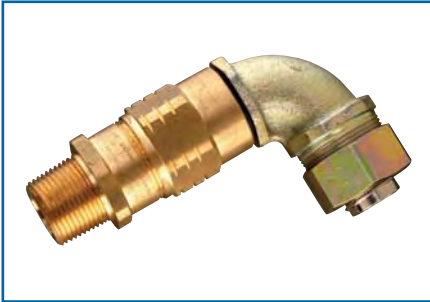

Nickel Plated Type - Metric	Conduit Size Metric (mm)	Thread Size Metric (mm)
HAMM0304E	16	20
HAMM0404E	20	20
HAMM0505E	25	25
HAMM0606E	32	32
HAMM0707E	40	40
HAMM0808E	50	50
HAMM0909E	63	63

Nickel Plated Type - NPT	Conduit Size Metric (mm)	Thread Size NPT (inch)
HAAM0304E	16	1/2
HAAM0404E	20	1/2
HAAM0505E	25	3/4
HAAM0606E	32	1
HAAM0707E	40	1 1/4
HAAM0808E	50	1 1/2
HAAM0909E	63	2

Brass Type - Metric	Conduit Size Metric (mm)	Thread Size Metric (mm)
HAM0304E	16	20
HAM0404E	20	20
HAM0505E	25	25
HAM0606E	32	32
HAM0707E	40	40
HAM0808E	50	50
HAM0909E	63	63

Brass Type - NPT	Conduit Size Metric (mm)	Thread Size NPT (inch)
HAA0304E	16	1/2
HAA0404E	20	1/2
HAA0505E	25	3/4
HAA0606E	32	1
HAA0707E	40	1 1/4
HAA0808E	50	1 1/2
HAA0909E	63	2

Stainless Steel gland available but elbow is Nickel Plated

Elbow supplied is for liquid tight conduit only

See page 148-151 for suitable conduits

For Accessories see page 178-79

Related Products



General Oil Resistant 148

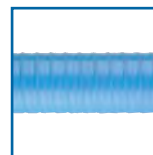

High Temperature Conduit 150



Low Fire Flexible Conduit 150

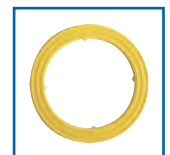

Sealing Washers 178



Universal Glands

Liquid tight hazardous area flameproof glands



Approvals / Characteristics



Features

- Constructed from either Brass or Stainless Steel with an epoxy resin barrier
- The Group I Universal Flameproof Gland is a high specification product, ideal for all hazardous area applications

Certification & Standards

EC TYPE Examination Certificate:
 ATEX: Sira 09 ATEX 1231X
 IECEx: IECEx SIR09.0103X
 CSA: CSA File No: 2310045
 GOST R: POCC GB.ГБ05.В03850
 INMETRO: TÜV 11.0339X
 Ex de I Mb
 Ex de IIC Gb
 Ex tb IIIC Db
 Class I Div 1 BCD (Rigid conduit only)
 Class I Div 2 ABCD
 Class II Div 1 ABCD
 Temperature: -60°C to +130°C

Liquid tight hazardous area flameproof Universal glands

Technical Specifications

Dimensions

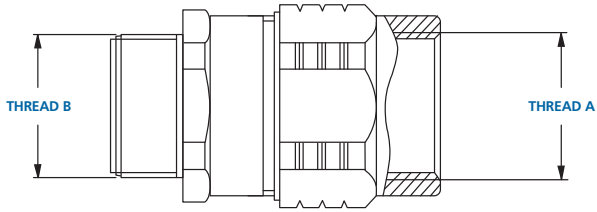

HAM 03 04 U

Thread A = M16 Thread B = M20

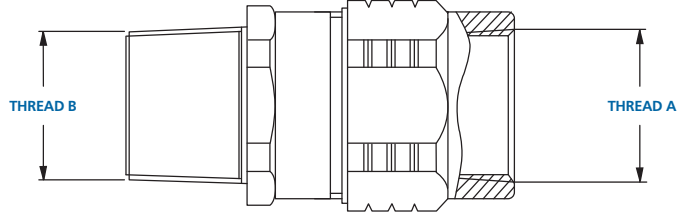

HAA 03 04 U

Thread A = 3/8" NPT Thread B = 1/2" NPT



Universal Gland

Nickel Plated Type - Metric	Male Thread Size Metric (mm)	Female Thread Size Metric (mm)
HAMM0304U	20	16
HAMM0404U	20	20
HAMM0505U	25	25
HAMM0606U	32	32
HAMM0707U	40	40
HAMM0808U	50	50
HAMM0909U	63	63

Nickel Plated Type - NPT	Male Thread Size NPT (inch)	Female Thread Size NPT (inch)
HAAM0304U	1/2	3/8
HAAM0404U	1/2	1/2
HAAM0505U	3/4	3/4
HAAM0606U	1	1
HAAM0707U	1 1/4	1 1/4
HAAM0808U	1 1/2	1 1/2
HAAM0909U	2	2

Brass Type - Metric	Male Thread Size Metric (mm)	Female Thread Size Metric (mm)
HAM0304U	20	16
HAM0404U	20	20
HAM0505U	25	25
HAM0606U	32	32
HAM0707U	40	40
HAM0808U	50	50
HAM0909U	63	63

Brass Type - NPT	Male Thread Size NPT (inch)	Female Thread Size NPT (inch)
HAA0304U	1/2	3/8
HAA0404U	1/2	1/2
HAA0505U	3/4	3/4
HAA0606U	1	1
HAA0707U	1 1/4	1 1/4
HAA0808U	1 1/2	1 1/2
HAA0909U	2	2

Stainless Steel Type - Metric	Male Thread Size Metric (mm)	Female Thread Size Metric (mm)
HAMS0304U	20	16
HAMS0404U	20	20
HAMS0505U	25	25
HAMS0606U	32	32
HAMS0707U	40	40
HAMS0808U	50	50
HAMS0909U	63	63

Stainless Steel Type - NPT	Male Thread Size NPT (inch)	Female Thread Size NPT (inch)
HAAS0304U	1/2	3/8
HAAS0404U	1/2	1/2
HAAS0505U	3/4	3/4
HAAS0606U	1	1
HAAS0707U	1 1/4	1 1/4
HAAS0808U	1 1/2	1 1/2
HAAS0909U	2	2

For use with Rigid conduit or other fittings

Liquid Tight Hazardous Area Flameproof Universal Glands



Dimensions

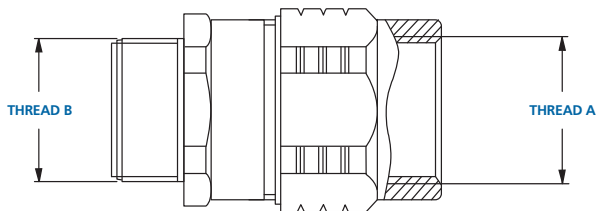

HAM 03 04 U/SW

Thread A = M16

Thread B = M20

Technical Specifications

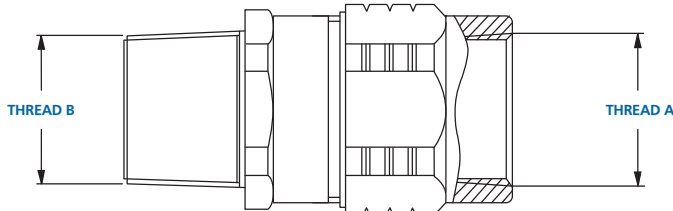

HAA 03 04 U/SW

Thread A = 3/8" NPT

Thread B = 1/2" NPT



Universal Swivel Gland

Nickel Plated Type - Metric	Male Thread Size Metric (mm)	Female Thread Size Metric (mm)
HAMM0304U/SW	20	16
HAMM0404U/SW	20	20
HAMM0505U/SW	25	25
HAMM0606U/SW	32	32
HAMM0707U/SW	40	40
HAMM0808U/SW	50	50
HAMM0909U/SW	63	63

Brass Type - Metric	Male Thread Size Metric (mm)	Female Thread Size Metric (mm)
HAM0304U/SW	20	16
HAM0404U/SW	20	20
HAM0505U/SW	25	25
HAM0606U/SW	32	32
HAM0707U/SW	40	40
HAM0808U/SW	50	50
HAM0909U/SW	63	63

Nickel Plated Type - NPT	Male Thread Size NPT (inch)	Female Thread Size NPT (inch)
HAAM0304U/SW	1/2	3/8
HAAM0404U/SW	1/2	1/2
HAAM0505U/SW	3/4	3/4
HAAM0606U/SW	1	1
HAAM0707U/SW	1 1/4	1 1/4
HAAM0808U/SW	1 1/2	1 1/2
HAAM0909U/SW	2	2

Brass Type - NPT	Male Thread Size NPT (inch)	Female Thread Size NPT (inch)
HAA0304U/SW	1/2	3/8
HAA0404U/SW	1/2	1/2
HAA0505U/SW	3/4	3/4
HAA0606U/SW	1	1
HAA0707U/SW	1 1/4	1 1/4
HAA0808U/SW	1 1/2	1 1/2
HAA0909U/SW	2	2

For use with Rigid conduit or other fittings

For Accessories see page 178-79

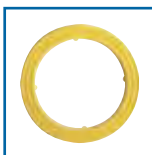

Sealing Washers 178

Related Products



Group II Gland

Liquid tight hazardous area flameproof gland



Approvals / Characteristics

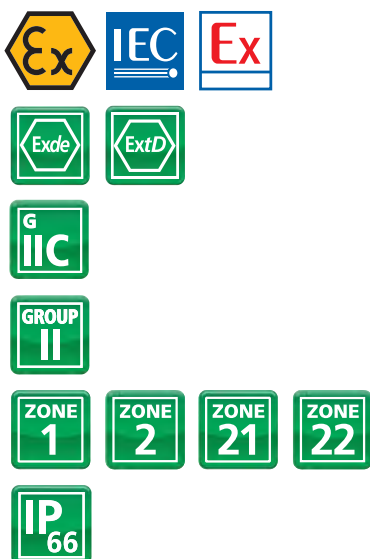

Features

- Constructed from either Brass or Stainless Steel with an epoxy resin barrier the Group II Flameproof Gland is a high specification product, ideal for all hazardous area applications

Certification & Standards

EC TYPE Examination Certificate:
 Baseefa 06 ATEX 0256X
 IECEx BAS06.0059X
 Ex d IIC
 Ex e II
 Ex tD A21
 Temperature: -60°C to +80°C

Liquid Tight Hazardous Area Flameproof Group II Gland

ATEX Flameproof Group II Gland

Technical Specifications



Nickel Plated Type - Metric	Conduit Size Metric (mm)	Thread Size Metric (mm)
HAMM0304	16	20
HAMM0404	20	20
HAMM0505	25	25
HAMM0606	32	32
HAMM0707	40	40
HAMM0808	50	50
HAMM0909	63	63

*See page 140-143 for suitable conduits

Brass Type - Metric	Conduit Size Metric (mm)	Thread Size Metric (mm)
HAM0304	16	20
HAM0404	20	20
HAM0505	25	25
HAM0606	32	32
HAM0707	40	40
HAM0808	50	50
HAM0909	63	63

*See page 140-143 for suitable conduits

Stainless Steel Type - Metric	Conduit Size Metric (mm)	Thread Size Metric (mm)
HAMS0304	16	20
HAMS0404	20	20
HAMS0505	25	25
HAMS0606	32	32
HAMS0707	40	40
HAMS0808	50	50
HAMS0909	63	63

*See page 140-143 for suitable conduits

Nickel Plated Type - NPT	Conduit Size Metric (mm)	Thread Size NPT (inch)
HAAM0304	16	1/2
HAAM0404	20	1/2
HAAM0505	25	3/4
HAAM0606	32	1
HAAM0707	40	1 1/4
HAAM0808	50	1 1/2
HAAM0909	63	2

*See page 140-143 for suitable conduits

Brass Type - NPT	Conduit Size Metric (mm)	Thread Size NPT (inch)
HAA0304	16	1/2
HAA0404	20	1/2
HAA0505	25	3/4
HAA0606	32	1
HAA0707	40	1 1/4
HAA0808	50	1 1/2
HAA0909	63	2

*See page 140-143 for suitable conduits

Stainless Steel Type - NPT	Conduit Size Metric (mm)	Thread Size NPT (inch)
HAAS0304	16	1/2
HAAS0404	20	1/2
HAAS0505	25	3/4
HAAS0606	32	1
HAAS0707	40	1 1/4
HAAS0808	50	1 1/2
HAAS0909	63	2

*See page 140-143 for suitable conduits

For Accessories see page 178-79



General Oil Resistant 148

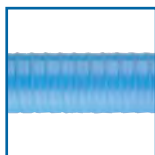

High Temperature Conduit 150



Low Fire Flexible Conduit 148

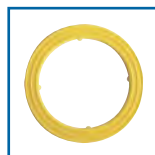

Sealing Washers 178

Related Products



XP Flex™ Range

Explosion-proof flexible couplings



Approvals / Characteristics



Features

- UL Listed for use in hazardous and wet locations
- Corrosion-resistant - ideal for washdown areas
- Flexible bronze construction with arc-resistant inner sleeve and brass fittings
- Terminated with two threaded female end fittings and male close nipples
- No bonding jumper required

Certification & Standards

UL Listed and CSA Certified for Hazardous Locations:
 0.5" and 0.75" Hub Sizes: Class I Div 1 & 2 ABCD;
 Class II Div 1 EFG, Class III
 1" Hub Size: Class I Div 1 & 2 CD;
 Class II Div 1 EFG, Class III
 UL Listed 886

Explosion-Proof Flexible Couplings - XP Flex™ Range

Dimensions

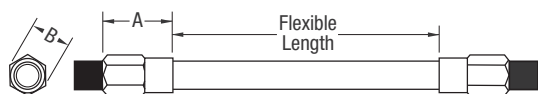

Technical Specifications



Type	Thread Type (inch)	Flexible Length (mm)	Dimensions (mm)	
			A	B
XPLFL16	1/2" NPT	150	39.1	36.6
XPLFL18	1/2" NPT	200	39.1	36.6
XPLFL110	1/2" NPT	250	39.1	36.6
XPLFL112	1/2" NPT	300	39.1	36.6
XPLFL115	1/2" NPT	380	39.1	36.6
XPLFL118	1/2" NPT	460	39.1	36.6
XPLFL124	1/2" NPT	610	39.1	36.6
XPLFL212	3/4" NPT	300	40.6	47.5
XPLFL215	3/4" NPT	380	40.6	47.5
XPLFL218	3/4" NPT	460	40.6	47.5
XPLFL224	3/4" NPT	610	40.6	47.5
XPLFL236	3/4" NPT	915	40.6	47.5
XPLFL318	1" NPT	460	50.08	58.7

Explosion-Proof and Dust- Ignition-Proof for Use in Hazardous Locations

With their flexible design, T&B® XP Flex™ Couplings make it easy to achieve tight bends in conduit systems in confined spaces - or to connect stationary equipment to equipment that moves or vibrates. Their explosion-proof and corrosion-resistant construction mean you can use them with confidence in hazardous and wet locations.

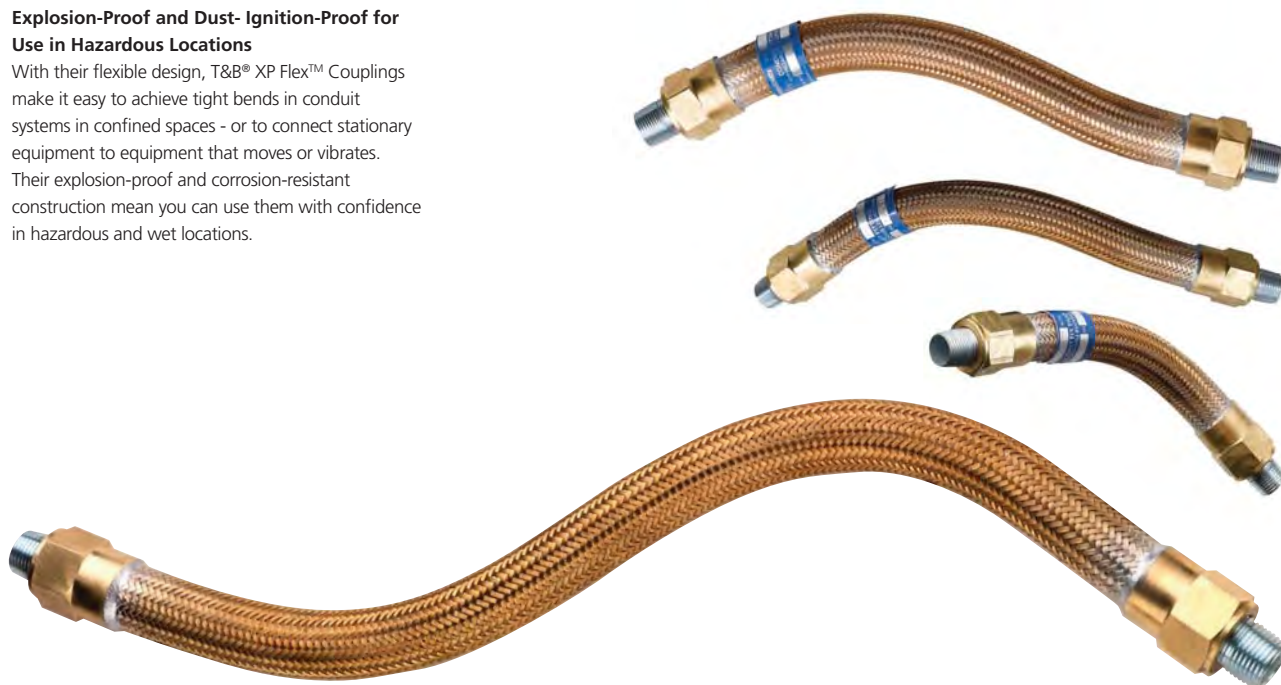

Enlargers, Reducers & Thread Convertors 170



Locknuts 178

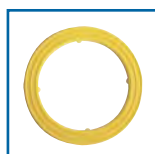

Sealing Washers 178

Related Products



Ex d Double Compression Cable Gland

4 Function double compression cable gland



Approvals / Characteristics



Features

- Flameproof Ex d and increased safety Ex e
- Available in Brass, Nickel Plated Brass and Stainless Steel 316
- Deluge proof
- Wide range of cable sizes

Certification & Standards

Approved to: EN 60079-0, 60079-1, 60079-7, 60079-31

EC TYPE Examination Certificate:

CESI 13 ATEX 041X, IECEX CES 13.0014X

Ex d IIC Gb

Ex e IIC Gb

Ex tb IIIC Db

Temperature:

-30°C to +120°C NBR sealing ring

-40°C to +100°C Neoprene sealing ring

-60°C to +180°C Silicon sealing ring

Ex d Double Compression Cable Gland

Dimensions

Technical Specifications

1. Lower Body
2. Lower Sealing Ring
3. O-Ring
4. Grounding Cone
5. Swivel Braid Retainer
6. Middle Body
7. Upper Sealing Ring
8. Pressure Cap

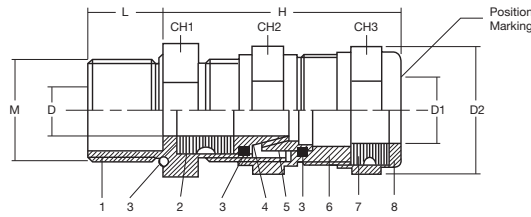

Brass Metric Type	Metric Size	Sealings Range		Cable Gland Dimensions						Torque (Nm)	
		D (min-max)	D1 (min-max)	H Min	L Min	CH1	CH2	CH3	D2 Min	CH2	CH3
EX03MSC1	M16	3 - 8.5	6 - 12	47	16	22	26	26	29	27.0	25.0
EX03MMC1	M16	6 - 12	8.5 - 16	48	16	25	29	29	31.5	49.0	28.0
EX04MSC1	M20	3 - 8.5	6 - 12	47	16	24	26	26	29	27.0	25.0
EX04MMC1	M20	6 - 12	8.5 - 16	47	16	25	29	29	31.5	49.0	28.0
EX04MLC1	M20	12 - 14.5	16 - 20	50	16	28	30	32	35	33.0	33.0
EX05MSC1	M25	6 - 12	8.5 - 16	48	18	29	29	29	31.5	49.0	28.0
EX05MMC1	M25	12 - 16	16 - 21	53	18	32	34	34	37	30.0	27.0
EX05MLC1	M25	12 - 20	16 - 26	60	18	36	40	40	44	61.0	32.0
EX06MSC1	M32	12 - 20	16 - 26	62	18	40	40	40	44	61.0	32.0
EX06MMC1	M32	15 - 26	20 - 33	78	18	48	52	52	57	86.0	40.0
EX07MSC1	M40	15 - 26	20 - 33	78	18	48	52	52	57	86.0	40.0
EX07MMC1	M40	20 - 32	29 - 41	89	18	55	60	60	66	110.0	75.0
EX08MSC1	M50	22 - 35	33 - 48	97	18	60	70	75	82	110.0	75.0
EX08MMC1	M50	27 - 41	36 - 52	100	18	70	70	74	83	125.0	75.0
EX09MSC1	M63	35 - 45	43 - 57	106	20	75	80	80	89.5	160.0	140.0
EX09MMC1	M63	40 - 52	47 - 60	107	20	85	85	85	94	250.0	100.0
EX10MSC1	M75	40 - 52	47 - 60	107	20	85	85	85	94	250.0	100.0
EX10MMC1	M75	45 - 60	54 - 70	125	20	90	95	100	110.5	250.0	150.0
EX11MSC1	M90	45 - 60	54 - 70	125	20	95	95	100	110.5	250.0	150.0
EX11MMC1	M90	60 - 72	63 - 80	154	20	110	115	115	127	320.0	210.0

Brass NPT Type	NPT (inch)	Sealings Range		Cable Gland Dimensions						Torque (Nm)	
		D (min-max)	D1 (min-max)	H Min	L Min	CH1	CH2	CH3	D2 Min	CH2	CH3
EX03ASC1	3/8"	3 - 8.5	6 - 12	47	16	22	26	26	29	27.0	25.0
EX03AMC1	3/8"	6 - 12	8.5 - 16	48	16	25	29	29	31.5	49.0	28.0
EX04ASC1	1/2"	3 - 8.5	6 - 12	47	21	24	26	26	29	27.0	25.0
EX04AMC1	1/2"	6 - 12	8.5 - 16	47	21	25	29	29	31.5	49.0	28.0
EX04ALC1	1/2"	12 - 14.5	16 - 20	50	21	28	30	32	35	33.0	33.0
EX05ASC1	3/4"	6 - 12	8.5 - 16	48	21	29	29	29	31.5	49.0	28.0
EX05AMC1	3/4"	12 - 16	16 - 21	53	21	32	34	34	37	30.0	27.0
EX05ALC1	3/4"	12 - 20	16 - 26	60	21	36	40	40	44	61.0	32.0
EX06ASC1	1"	12 - 20	16 - 26	62	26	40	40	40	44	61.0	32.0
EX06AMC1	1"	15 - 26	20 - 33	78	26	48	52	52	57	86.0	40.0
EX07ASC1	1 1/4"	15 - 26	20 - 33	78	28	48	52	52	57	86.0	40.0
EX07AMC1	1 1/4"	20 - 32	29 - 41	89	28	55	60	60	66	110.0	75.0
EX08ASC1	1 1/2"	22 - 35	33 - 48	97	28	60	70	75	82	110.0	75.0
EX08AMC1	1 1/2"	27 - 41	36 - 52	100	28	70	70	74	83	125.0	75.0
EX09ASC1	2"	35 - 45	43 - 57	106	28	75	80	80	89.5	160.0	140.0
EX09AMC1	2"	40 - 52	47 - 60	107	28	85	85	85	94	250.0	100.0
EX10ASC1	2 1/2"	40 - 52	47 - 60	107	41	85	85	85	94	250.0	100.0
EX10AMC1	2 1/2"	45 - 60	54 - 70	125	41	90	95	100	110.5	250.0	150.0
EX11ASC1	3"	45 - 60	54 - 70	125	43	95	95	100	110.5	250.0	150.0
EX11AMC1	3"	60 - 72	63 - 80	154	43	110	115	115	127	320.0	210.0

*For Nickel Plated Brass version, add N to the reference, e.g. EXN03MSC1 for Metric / EXN03ASC1 for NPT

**For Stainless Steel 316 version, add S to the reference, e.g. EXS03MSC1 for Metric / EXS03ASC1 for NPT

Connector Description: EX - Brass / EXN - Nickel Plated Brass / EXS - Stainless Steel 316



Ex d Single Compression Cable Gland

Single compression cable gland



Approvals / Characteristics



Features

- Flameproof Ex d and increased safety Ex e
- Available in Brass, Nickel Plated Brass and Stainless Steel 316
- Deluge proof
- Wide range of cable sizes

Certification & Standards

Approved to: EN 60079-0, 60079-1, 60079-7, 60079-31

EC TYPE Examination Certificate:

CESI 13 ATEX 041X, IECEx CES 13.0014X

Ex d IIC Gb

Ex e IIC Gb

Ex tb IIIC Db

Temperature:

-30°C to +120°C NBR sealing ring

-40°C to +100°C Neoprene sealing ring

-60°C to +180°C Silicon sealing ring

Ex d Single Compression Cable Gland

Dimensions

Technical Specifications

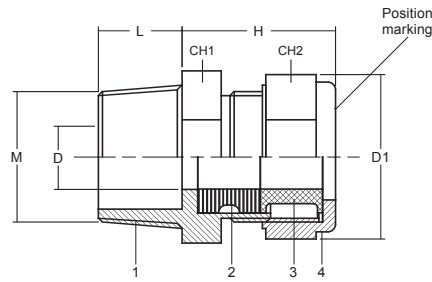

Brass Metric Type	Metric Size	Sealings Range		Cable Gland Dimensions				Torque (Nm)
		D (min-max)	H Min	L Min	CH1	CH2	D1 Min	
EX03MMC3	M16	28.5	25.0	29.0	31.5	6 - 12	35	16
EX04MSC3	M20	27.5	25	29	31.5	6 - 12	35	16
EX04MMC3	M20	29	28	30	33.5	6 - 12	33	16
EX05MSC3	M25	28.5	29	29	31.5	12 - 14.5	35	18
EX05MMC3	M25	28.5	32	35	37	6 - 12	30	18
EX05MLC3	M25	32.5	36	40	44.5	6 - 12	61	18
EX06MSC3	M32	33.5	40	40	44.5	12 - 16	61	18
EX06MMC3	M32	41	48	52	57	12 - 20	86	18
EX07MSC3	M40	41	48	52	57	15 - 26	86	18
EX07MMC3	M40	50	55	60	66	15 - 26	110	18
EX08MSC3	M50	50.5	60	70	77	20 - 32	110	18
EX08MMC3	M50	54	70	70	77	22 - 35	125	18
EX09MSC3	M63	61.5	75	80	89.5	27 - 41	165	20
EX09MMC3	M63	61.5	85	85	94	35 - 45	250	20
EX10MSC3	M75	61.5	85	85	94	40 - 52	250	20
EX10MMC3	M75	72	90	95	105	40 - 52	250	20
EX11MSC3	M90	72	95	85	105	45 - 60	250	20
EX11MMC3	M90	84	110	115	127	60 - 72	300	20

Brass NPT Type	NPT (inch)	Sealings Range		Cable Gland Dimensions				Torque (Nm)
		D (min-max)	H Min	L Min	CH1	CH2	D1 Min	
EX03AMC3	3/8"	28.5	25	29	31.5	6 - 12	35	16
EX04ASC3	1/2"	27.5	25	29	31.5	6 - 12	35	21
EX04AMC3	1/2"	29	28	30	33.5	12 - 14.5	33	21
EX05ASC3	3/4"	28.5	29	29	31.5	6 - 12	35	21
EX05ALC3	3/4"	32.5	36	40	44.5	12 - 20	61	21
EX06ASC3	3/4"	33.5	40	40	44.5	12 - 20	61	26
EX06AMC3	3/4"	41.0	48	52	57	15 - 26	86	26
EX07ASC3	1"	41.0	48	52	57	15 - 26	86	28
EX07AMC3	1"	50	55	60	66	20 - 32	110	28
EX08ASC3	1 1/4"	50.5	60	70	77	22 - 35	110	28
EX08AMC3	2 1/4"	54	70	70	77	27 - 41	125	28
EX09ASC3	1 1/2"	61.5	75	80	89.5	35 - 45	165	28
EX09AMC3	1 1/2"	61.5	85	85	94	40 - 52	250	28
EX10ASC3	2"	61.5	85	85	94	40 - 52	250	41
EX10AMC3	2"	72	90	95	105	45 - 60	250	41
EX11ASC3	2 1/2"	72	95	95	105	45 - 60	250	43
EX11AMC3	3 1/2"	84	110	115	127	60 - 72	300	43

*For Nickel Plated Brass version, add N to the reference, e.g. EXN03MMC3 for Metric / EXN03AMC3 for NPT

**For Stainless Steel 316 version, add S to the reference, e.g. EXS03MMC3 for Metric / EXS03AMC3 for NPT

Connector Description: EX - Brass / EXN - Nickel Plated Brass / EXS - Stainless Steel 316



Ex e Cable Gland

Single compression cable gland



Approvals / Characteristics



Features

- Flameproof Ex d and increased safety Ex e
- Available in Brass, Nickel Plated Brass and Stainless Steel 316
- Large cable range within one product with removable seals

Certification & Standards

Approved to: EN 60079-0:2012, EN 60079-1:2007, EN 60079-7:2007, EN 60079-11:2010, EN 60079-31:2009

EC TYPE Examination Certificate:

IMQ 13 ATEX 015X

II 2GD / Exe IIC Gb -30°C to +120°C

Ex tb IIIC Db

IP test: IP66

Temperature:

-30°C to +120°C NBR sealing ring

-40°C to +100°C Neoprene sealing ring

-60°C to +180°C Silicon sealing ring

Dimensions

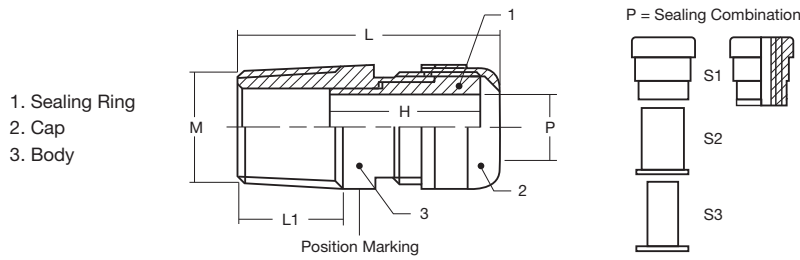

Brass Metric		Cable Gland Dimensions				Sealing Ring Dimensions				Torque (Nm)
Type	Metric Size	L	L Min	CH	H Min	Min-Max	S1+S2+S3	S1+S2	S1	
EX03MMC2	M16	40	16	22	20	3 - 12	3 - 6	6 - 9	9 - 12	19
EX04MSC2	M20	40	16	22	20	3 - 12	3 - 6	6 - 9	9 - 12	19
EX04MMC2	M20	45	16	28	20	10 - 16	-	10 - 14	14 - 16	28
EX05MSC2	M25	40	16	28	20	10 - 16	-	10 - 14	14 - 16	28
EX05MMC2	M25	50	16	35	25	14 - 20	-	14 - 17	17 - 20	31
EX06MSC2	M32	43	16	35	25	14 - 24	14 - 17	17 - 20	20 - 24	31
EX06MMC2	M32	53	16	45	39	22 - 28	-	22 - 26	26 - 28	26
EX07MSC2	M40	45	18	45	39	22 - 32	-	22 - 26	26 - 32	26
EX07MMC2	M40	55	18	50	32	26 - 34	-	26 - 32	32 - 34	58
EX08MSC2	M50	46	18	55 / 50	32	26 - 35	-	26 - 30	30 - 35	58
EX08MMC2	M50	63	18	55 / 58	38	35 - 42	-	35 - 38	38 - 42	68
EX09MSC2	M63	53	18	68 / 58	38	35 - 45	-	35 - 38	38 - 45	60
EX09MMC2	M63	62	18	75 / 80	25	46 - 56	-	46 - 51	51 - 56	75
EX10MSC2	M75	64	20	80	25	46 - 62	46 - 51	51 - 57	57 - 62	75
EX10MMC2	M75	75	20	95	36	60 - 69	-	60 - 63	63 - 69	110
EX11MSC2	M90	75	20	95	36	60 - 75	60 - 63	63 - 69	69 - 75	110
EX11MMC2	M90	77	20	105	38	75 - 82	-	75 - 79	79 - 82	130
EX12MSC2	M100	77	20	115 / 105	38	75 - 85	75 - 79	79 - 82	82 - 85	130
EX12MMC2	M100	77	20	115	38	85 - 95	85 - 89	89 - 92	92 - 95	140

Brass NPT		Cable Gland Dimensions				Sealing Ring Dimensions				Torque (Nm)
Type	NPT (inch)	L	L Min	CH	H Min	Min-Max	S1+S2+S3	S1+S2	S1	
EX03AMC2	3/8"	40	16	22	20	3 - 12	3 - 6	6 - 9	9 - 12	19
EX04ASC2	1/2"	40	16	22	20	3 - 12	3 - 6	6 - 9	9 - 12	19
EX04AMC2	1/2"	45	16	28	20	10 - 16	-	10 - 14	14 - 16	28
EX05ASC2	3/4"	40	16	28	20	10 - 16	-	10 - 14	14 - 16	28
EX05AMC2	3/4"	50	16	35	25	14 - 20	-	14 - 17	17 - 20	31
EX06ASC2	1"	47	20	35	25	14 - 24	14 - 17	17 - 20	20 - 24	31
EX06AMC2	1"	57	20	45	39	22 - 28	-	22 - 26	26 - 28	26
EX07ASC2	1 1/4"	47	20	45	39	22 - 32	-	22 - 26	26 - 32	26
EX07AMC2	1 1/4"	57	20	50	32	26 - 34	-	26 - 32	32 - 34	58
EX08ASC2	1 1/2"	48	20	55 / 50	32	26 - 35	-	26 - 30	30 - 35	58
EX08AMC2	1 1/2"	65	20	55 / 58	38	35 - 42	-	35 - 38	38 - 42	60
EX09ASC2	2"	55	20	68 / 58	38	35 - 45	-	35 - 38	38 - 45	60
EX09AMC2	2"	64	20	75 / 80	25	46 - 56	-	46 - 51	51 - 56	75
EX10ASC2	2 1/2"	70	26	80	25	46 - 62	46 - 51	51 - 57	57 - 62	75
EX10AMC2	2 1/2"	81	26	95	36	60 - 69	-	60 - 63	63 - 69	110
EX11ASC2	3"	81	26	95	36	60 - 75	60 - 63	63 - 69	69 - 75	110
EX11AMC2	3"	83	26	105	38	75 - 82	-	75 - 79	79 - 82	130
EX12ASC2	4"	83	26	115 / 105	38	75 - 85	75 - 79	79 - 82	82 - 85	130
EX12AMC2	4"	83	26	115	38	85 - 95	85 - 89	89 - 92	92 - 95	140

*For Nickel Plated Brass version, add N to the reference, e.g. EXN03MMC2 for Metric / EXN03AMC2 for NPT

**For Stainless Steel 316 version, add S to the reference, e.g. EXS03MMC2 for Metric / EXS03AMC2 for NPT

Connector Description: EX - Brass / EXN - Nickel Plated Brass / EXS - Stainless Steel 316



Nylon Cable Gland

Ex e nylon cable gland



Approvals / Characteristics



Features

- Suitable for potentially explosive gas atmospheres
- Increased safety "e" and intrinsic safety "i"

Certification & Standards

Approved to: EN 60079-0, 60079-7, 60079-11, 60079-31
 EC TYPE Examination Certificate:
 IMQ 13 ATEX 016X, IECEx IMQ 13.0005X
 Ex e IIC Gb
 Ex tb IIIC Db
 IP test: IP66-IP68
 Temperature: -20°C to +80°C

Dimensions

Technical Specifications

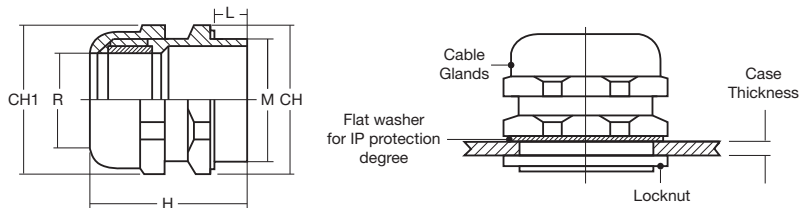

Type	Metric Size	Min - Max	Dimensions				Torque (Nm)
			L	H min	CH	CH1	
EXCGM20S	20	6,0 - 12,0	10	40	24	24	5
EXCGM20SL	20	6,0 - 12,0	15	45	24	24	5
EXCGM20M	20	10,0 - 14,0	10	42	27	27	5.5
EXCGM20ML	20	10,0 - 14,0	15	50	27	27	5.5
EXCGM25S	25	13,0 - 18,0	10	47	33	33	7
EXCGM25SL	25	13,0 - 18,0	15	50	33	33	7
EXCGM25M	25	11,0 - 17,0	8	42.5	29	29	5
EXCGM32S	32	15,0 - 21,0	10	50	36	36	6
EXCGM32M	32	18,0 - 25,0	15	68	42	42	9
EXCGM40S	40	19,0 - 28,0	10	55	46	46	5
EXCGM40M	40	22,0 - 32,0	18	68	53	53	17
EXCGM50S	50	30,0 - 38,0	18	73	60	60	22
EXCGM63S	63	34,0 - 44,0	18	74	65	65	23

Type	NPT Size (inch)	Min - Max	Dimensions				Torque (Nm)
			L	H min	CH	CH1	
EXCG050S	1/2"	6 - 12	15	45	24	24	5
EXCG050M	1/2"	10 - 14	15	47	27	27	5.5
EXCG075S	3/4"	13 - 18	15	50	33	33	7
EXCG100S	1"	18 - 25	18	58	42	42	9

For Accessories see page 178-79



EVS Range 42



XB100 Range 104



XBi Range 116

Related Products



Thread Convertors

Enlargers, reducers & convertors



Approvals / Characteristics



Features

- Adaptors and Reducers provide a method of matching threadforms on hazardous approved equipment whilst ensuring the integrity and approval of the installation is maintained

Certification & Standards

Certification Standard:
 ATEX: Baseefa07 ATEX 0247X,
 IECEx: IECEx BAS07.0090X
 GOST R: POCC GB.ГБ05.В03850
 INMETRO: TÜV 11.0339X
 Ex d IIC Gb
 Ex e IIC Gb
 Ex tb IIIC Db
 Class I Div1 ABCD, Class II Div1 EFG
 (does not include M16 & 3/8"NPT or unplated brass products)
 Approved to UL 1203
 Approved to CSA C22.2 No.60079-04
 Approved to C22.2 No.60079-1

Metric - Technical Specification

Male External Thread	Metric Female Internal Thread							
	M16	M20	M25	M32	M40	M50	M63	M75
M16		EX/M16-M20/E	EX/M16-M25/E					
M20	EX/M20-M16/R		EX/M20-M25/E	EX/M20-M32/E				
M25	EX/M25-M16/R	EX/M25-M20/R		EX/M25-M32/E	EX/M25-M40/E			
M32	EX/M32-M16/R	EX/M32-M20/R	EX/M32-M25/R		EX/M32-M40/E	EX/M32-M50/E		
M40	EX/M40-M16/R	EX/M40-M20/R	EX/M40-M25/R	EX/M40-M32/R		EX/M40-M50/E	EX/M40-M63/E	
M50	EX/M50-M16/R	EX/M50-M20/R	EX/M50-M25/R	EX/M50-M32/R	EX/M50-M40/R		EX/M50-M63/E	EX/M50-M75/E
M63	EX/M63-M16/R	EX/M63-M20/R	EX/M63-M25/R	EX/M63-M32/R	EX/M63-M40/R	EX/M63-M50/R		EX/M63-M75/E
M75	EX/M75-M16/R	EX/M75-M20/R	EX/M75-M25/R	EX/M75-M32/R	EX/M75-M40/R	EX/M75-M50/R	EX/M75-M63/R	
PG9	EX/PG9-M16/TC	EX/PG9-M20/TC						
PG11	EX/PG11-M16/TC	EX/PG11-M20/TC						
PG13	EX/PG13-M16/TC	EX/PG13-M20/TC						
PG16	EX/PG16-M16/TC	EX/PG16-M20/TC	EX/PG16-M25/TC					
PG21	EX/PG21-M16/TC	EX/PG21-M20/TC	EX/PG21-M25/TC	EX/PG21-M32/TC				
PG29	EX/PG29-M16/TC	EX/PG29-M20/TC	EX/PG29-M25/TC	EX/PG29-M32/TC	EX/PG29-M40/TC			
PG36	EX/PG36-M16/TC	EX/PG36-M20/TC	EX/PG36-M25/TC	EX/PG36-M32/TC	EX/PG36-M40/TC	EX/PG36-M50/TC		
PG42	EX/PG42-M16/TC	EX/PG42-M20/TC	EX/PG42-M25/TC	EX/PG42-M32/TC	EX/PG42-M40/TC	EX/PG42-M50/TC	EX/PG42-M63/TC	
PG48	EX/PG48-M16/TC	EX/PG48-M20/TC	EX/PG48-M25/TC	EX/PG48-M32/TC	EX/PG48-M40/TC	EX/PG48-M50/TC	EX/PG48-M63/TC	
NPT 3/8	EX/038-M16/TC							
NPT 1/2	EX/050-M16/TC	EX/050-M20/TC	EX/050-M25/TC					
NPT 3/4	EX/075-M16/TC	EX/075-M20/TC	EX/075-M25/TC	EX/075-M32/TC				
NPT 1	EX/100-M16/TC	EX/100-M20/TC	EX/100-M25/TC	EX/100-M32/TC	EX/100-M40/TC			
NPT 1 1/4	EX/125-M16/TC	EX/125-M20/TC	EX/125-M25/TC	EX/125-M32/TC	EX/125-M40/TC	EX/125-M50/TC		
NPT 1 1/2	EX/150-M16/TC	EX/150-M20/TC	EX/150-M25/TC	EX/150-M32/TC	EX/150-M40/TC	EX/150-M50/TC	EX/150-M63/TC	
NPT 2	EX/200-M16/TC	EX/200-M20/TC	EX/200-M25/TC	EX/200-M32/TC	EX/200-M40/TC	EX/200-M50/TC	EX/200-M63/TC	
NPT 2 1/2	EX/250-M16/TC	EX/250-M20/TC	EX/250-M25/TC	EX/250-M32/TC	EX/250-M40/TC	EX/250-M50/TC		
NPT 3	EX/300-M16/TC	EX/300-M20/TC	EX/300-M25/TC	EX/300-M32/TC	EX/300-M40/TC	EX/300-M50/TC		EX/300-M75/TC

*For Nickel Plated Brass version, add N to the reference, e.g. EXNM20-M16/R
 **For Stainless Steel 316 version, add S to the reference, e.g. EXSM20-M16/R

Connector Description:

EX - Brass
 EXN - Nickel Plated Brass
 EXS - Stainless Steel 316

Enlargers (/E) are used where the thread size of the female side of the device is larger than the male side.

Reducers (/R) are used where the thread size of the female side of device is smaller than the male side.

Thread Convertors (/TC) are used where a conversion is required between thread types, e.g. Metric to PG.

Our comprehensive range of Adaptors and Reducers provide a method of matching threadforms on hazardous area approved equipment whilst ensuring the integrity and approval of the installation is maintained.

Manufactured in the UK, this new range of converters meets the latest ATEX / IECEx & CSA / UL standards. This means that all the standards are marked on the product around the main body. This allows for them to be seen easily once installed, a key component of the new standard.

Kopex's Enlargers, Reducers and thread converters are designed for hazardous area applications and are certified to protection concepts Exd "Flameproof" and Exe "Increased Safety" for use in Zone 1, 2, 2.1, 2.2 applications. Under NEC Class I Div1 ABCD Class II Div1 EFG.



EFDC Range 122



GUV Range 120



XB100 Range 104

Related Products



NPT - Technical Specification

Male External Thread	NPT Female Internal Thread							
	NPT 1/2	NPT 3/4	NPT 1	NPT 1 1/4	NPT 1 1/2	NPT 2	NPT 2 1/2	NPT 3
M16	EX/M16-050/TC							
M20	EX/M20-050/TC	EX/M20-075/TC						
M25	EX/M25-050/TC	EX/M25-075/TC	EX/M25-100/TC					
M32	EX/M32-050/TC	EX/M32-075/TC	EX/M32-100/TC	EX/M32-125/TC				
M40	EX/M40-050/TC	EX/M40-075/TC	EX/M40-100/TC	EX/M40-125/TC	EX/M40-150/TC			
M50	EX/M50-050/TC	EX/M50-075/TC	EX/M50-100/TC	EX/M50-125/TC	EX/M50-150/TC	EX/M50-200/TC		
M63	EX/M63-050/TC	EX/M63-075/TC	EX/M63-100/TC	EX/M63-125/TC	EX/M63-150/TC	EX/M63-200/TC		
M75	EX/M75-050/TC	EX/M75-075/TC	EX/M75-100/TC	EX/M75-125/TC	EX/M75-150/TC	EX/M75-200/TC		
PG9	EX/PG9-050/TC							
PG11	EX/PG11-050/TC							
PG13	EX/PG13-050/TC							
PG16	EX/PG16-050/TC	EX/PG16-075/TC						
PG21	EX/PG21-050/TC	EX/PG21-075/TC	EX/PG21-100/TC					
PG29	EX/PG29-050/TC	EX/PG29-075/TC	EX/PG29-100/TC	EX/PG29-125/TC	EX/PG29-150/TC			
PG36	EX/PG36-050/TC	EX/PG36-075/TC	EX/PG36-100/TC	EX/PG36-125/TC	EX/PG36-150/TC			
PG42	EX/PG42-050/TC	EX/PG42-075/TC	EX/PG42-100/TC	EX/PG42-125/TC	EX/PG42-150/TC	EX/PG42-200/TC		
PG48	EX/PG48-050/TC	EX/PG48-075/TC	EX/PG48-100/TC	EX/PG48-125/TC	EX/PG48-150/TC	EX/PG48-200/TC		
NPT 1/2		EX/050-075/E						
NPT 3/4	EX/075-050/R		EX/075-100/E					
NPT 1	EX/100-050/R	EX/100-075/R		EX/100-125/E				
NPT 1 1/4	EX/125-050/R	EX/125-075/R	EX/125-100/R		EX/125-150/E			
NPT 1 1/2	EX/150-050/R	EX/150-075/R	EX/150-100/R	EX/150-125/R		EX/150-200/E		
NPT 2	EX/200-050/R	EX/200-075/R	EX/200-100/R	EX/200-125/R	X/200-150/R			
NPT 2 1/2	EX/250-050/R	EX/250-075/R	EX/250-100/R	EX/250-125/R	EX/250-150/R	EX/250-200/R		EX/250-300/E
NPT 3	EX/300-050/R	EX/300-075/R	EX/300-100/R	EX/300-125/R	EX/300-150/R	EX/300-200/R	EX/300-250/R	

*For Nickel Plated Brass version, add N to the reference, e.g. EXNIM20-M16/R

**For Stainless Steel 316 version, add S to the reference, e.g. EXSIM20-M16/R

PG - Technical Specification

Male External Thread	PG Female Internal Thread								
	PG9	PG11	PG13	PG16	PG21	PG29	PG36	PG42	PG48
M16	EX/M16-PG9/TC	EX/M16-PG11/TC	EX/M16-PG13/TC						
M20	EX/M20-PG9/TC	EX/M20-PG11/TC	EX/M20-PG13/TC	EX/M20-PG16/TC					
M25	EX/M25-PG9/TC	EX/M25-PG11/TC	EX/M25-PG13/TC	EX/M25-PG16/TC	EX/M25-PG21/TC				
M32	EX/M32-PG9/TC	EX/M32-PG11/TC	EX/M32-PG13/TC	EX/M32-PG16/TC	EX/M32-PG21/TC	EX/M32-PG29/TC			
M40	EX/M40-PG9/TC	EX/M40-PG11/TC	EX/M40-PG13/TC	EX/M40-PG16/TC	EX/M40-PG21/TC	EX/M40-PG29/TC	EX/M40-PG36/TC		
M50	EX/M50-PG9/TC	EX/M50-PG11/TC	EX/M50-PG13/TC	EX/M50-PG16/TC	EX/M50-PG21/TC	EX/M50-PG29/TC	EX/M50-PG36/TC	EX/M50-PG42/TC	
M63	EX/M63-PG9/TC	EX/M63-PG11/TC	EX/M63-PG13/TC	EX/M63-PG16/TC	EX/M63-PG21/TC	EX/M63-PG29/TC	EX/M63-PG36/TC	EX/M63-PG42/TC	EX/M63-PG48/TC
M75	EX/M75-PG9/TC	EX/M75-PG11/TC	EX/M75-PG13/TC	EX/M75-PG16/TC	EX/M75-PG21/TC	EX/M75-PG29/TC	EX/M75-PG36/TC	EX/M75-PG42/TC	EX/M75-PG48/TC
PG11	EX/PG11-PG9/R								
PG13	EX/PG13-PG9/R	EX/PG13-PG11/R							
PG16	EX/PG16-PG9/R	EX/PG16-PG11/R	EX/PG16-PG13/R		EX/P16-PG21/E				
PG21	EX/PG21-PG9/R	EX/PG21-PG11/R	EX/PG21-PG13/R	EX/PG21-PG16/R		EX/PG21-PG29/E			
PG29	EX/PG29-PG9/R	EX/PG29-PG11/R	EX/PG29-PG13/R	EX/PG29-PG16/R	EX/PG29-PG21/R		EX/PG29-PG36/E		
PG36	EX/PG36-PG9/R	EX/PG36-PG11/R	EX/PG36-PG13/R	EX/PG36-PG16/R	EX/PG36-PG21/R	EX/PG36-PG29/R		EX/PG36-PG48/E	
PG42	EX/PG42-PG9/R	EX/PG42-PG11/R	EX/PG42-PG13/R	EX/PG42-PG16/R	EX/PG42-PG21/R	EX/PG42-PG29/R	EX/PG42-PG36/R		EX/PG42-PG48/E
PG48	EX/PG48-PG9/R	EX/PG48-PG11/R	EX/PG48-PG13/R	EX/PG48-PG16/R	EX/PG48-PG21/R	EX/PG48-PG29/R	EX/PG48-PG36/R	EX/PG48-PG42/R	
NPT 1/2	EX/050-PG9/TC	EX/050-PG11/TC	EX/050-PG13/TC	EX/050-PG16/TC					
NPT 3/4	EX/075-PG9/TC	EX/075-PG11/TC	EX/075-PG13/TC	EX/075-PG16/TC	EX/075-PG21/TC				
NPT 1	EX/100-PG9/TC	EX/100-PG11/TC	EX/100-PG13/TC	EX/100-PG16/TC	EX/100-PG21/TC	EX/100-PG29/TC			
NPT 1 1/4	EX/125-PG9/TC	EX/125-PG11/TC	EX/125-PG13/TC	EX/125-PG16/TC	EX/125-PG21/TC	EX/125-PG29/TC	EX/125-PG36/TC		
NPT 1 1/2	EX/150-PG9/TC	EX/150-PG11/TC	EX/150-PG13/TC	EX/150-PG16/TC	EX/150-PG21/TC	EX/150-PG29/TC	EX/150-PG36/TC	EX/150-PG42/TC	
NPT 2	EX/200-PG9/TC	EX/200-PG11/TC	EX/200-PG13/TC	EX/200-PG16/TC	EX/200-PG21/TC	EX/200-PG29/TC	EX/200-PG36/TC	EX/200-PG42/TC	EX/200-PG48/TC

*For Nickel Plated Brass version, add N to the reference, e.g. EXN/M20-M16/R

**For Stainless Steel 316 version, add S to the reference, e.g. EXS/M20-M16/R

Connector Description:

EX - Brass

EXN - Nickel Plated Brass

EXS - Stainless Steel 316

Enlargers (/E) are used where the thread size of the female side of the device is larger than the male side.

Reducers (/R) are used where the thread size of the female side of device is smaller than the male side.

Thread Convertors (/TC) are used where a conversion is required between thread types, e.g. Metric to PG.

Our comprehensive range of Adaptors and Reducers provide a method of matching threadforms on hazardous area approved equipment whilst ensuring the integrity and approval of the installation is maintained.

Manufactured in the UK, this new range of converters meets the latest ATEX / IECEx & CSA / UL standards. This means that all the standards are marked on the product around the main body.

This allows for them to be seen easily once installed, a key component of the new standard.

Kopex's Enlargers, Reducers and thread converters are designed for hazardous area applications and are certified to protection concepts Exd "Flameproof" and Exe "Increased Safety" for use in Zone 1, 2, 2.1, 2.2 applications. Under NEC Class I Div1 ABCD Class II Div1 EFG.



EFDC Range 122



GUV Range 120



XB100 Range 104

Related Products



Standard Ex d Stopping Plug & Tamperproof Ex d Stopping Plug

Exd stopping plugs



Approvals / Characteristics



Intertek



Features

- For use in potentially explosive atmospheres
- Manufactured from either Brass, Nickel Plated Brass or Stainless Steel

Certification & Standards

EC TYPE Examination Certificate:

ATEX: Baseefa 08 ATEX 6324

IECEX: IECEX BAS08.0109X

GOST R: POCC GB.ГБ05.В03850

INMETRO: TÜV 11.0093

UL 1203 (Nickel Plated Brass and Stainless Steel only)

Ex d I Mb

Ex d IIC Gb

Class I Div 1 ABCD

Class II Div 1 EFG

Temperature: -60°C to +130°C



Standard Exd Stopping Plug

Technical Specifications

Nickel Plated Type - Metric	Thread Size Metric (mm)	Brass Type - Metric	Thread Size Metric (mm)	Stainless Steel Type - Metric	Thread Size Metric (mm)
EXN/M16/SP	16	EX/M16/SP	16	EXS/M16/SP	16
EXN/M20/SP	20	EX/M20/SP	20	EXS/M20/SP	20
EXN/M25/SP	25	EX/M25/SP	25	EXS/M25/SP	25
EXN/M32/SP	32	EX/M32/SP	32	EXS/M32/SP	32
EXN/M40/SP	40	EX/M40/SP	40	EXS/M40/SP	40
EXN/M50/SP	50	EX/M50/SP	50	EXS/M50/SP	50
EXN/M63/SP	63	EX/M63/SP	63	EXS/M63/SP	63
Nickel Plated Type - NPT	Thread Size NPT (inch)	Brass Type - NPT	Thread Size NPT (inch)	Stainless Steel Type - NPT	Thread Size NPT (inch)
EXN/038/SP	3/8	EX/038/SP	3/8	EXS/038/SP	3/8
EXN/050/SP	1/2	EX/050/SP	1/2	EXS/050/SP	1/2
EXN/075/SP	3/4	EX/075/SP	3/4	EXS/075/SP	3/4
EXN/100/SP	1	EX/100/SP	1	EXS/100/SP	1
EXN/125/SP	1 1/4	EX/125/SP	1 1/4	EXS/125/SP	1 1/4
EXN/150/SP	1 1/2	EX/150/SP	1 1/2	EXS/150/SP	1 1/2
EXN/200/SP	2	EX/200/SP	2	EXS/200/SP	2

*Does not include M16 & 3/8 NPT or Unplated Brass products



Tamperproof Exd Stopping Plug

Nickel Plated Type - Metric	Thread Size Metric (mm)	Brass Type - Metric	Thread Size Metric (mm)	Stainless Steel Type - Metric	Thread Size Metric (mm)
EXN/M16/TSP	16	EX/M16/TSP	16	EXS/M16/TSP	16
EXN/M20/TSP	20	EX/M20/TSP	20	EXS/M20/TSP	20
EXN/M25/TSP	25	EX/M25/TSP	25	EXS/M25/TSP	25
EXN/M32/TSP	32	EX/M32/TSP	32	EXS/M32/TSP	32
EXN/M40/TSP	40	EX/M40/TSP	40	EXS/M40/TSP	40
EXN/M50/TSP	50	EX/M50/TSP	50	EXS/M50/TSP	50
EXN/M63/TSP	63	EX/M63/TSP	63	EXS/M63/TSP	63
Nickel Plated Type - NPT	Thread Size NPT (inch)	Brass Type - NPT	Thread Size NPT (inch)	Stainless Steel Type - NPT	Thread Size NPT (inch)
EXN/038/TSP	3/8	EX/038/TSP	3/8	EXS/038/TSP	3/8
EXN/050/TSP	1/2	EX/050/TSP	1/2	EXS/050/TSP	1/2
EXN/075/TSP	3/4	EX/075/TSP	3/4	EXS/075/TSP	3/4
EXN/100/TSP	1	EX/100/TSP	1	EXS/100/TSP	1
EXN/125/TSP	1 1/4	EX/125/TSP	1 1/4	EXS/125/TSP	1 1/4
EXN/150/TSP	1 1/2	EX/150/TSP	1 1/2	EXS/150/TSP	1 1/2
EXN/200/TSP	2	EX/200/TSP	2	EXS/200/TSP	2

*Does not include M16 & 3/8 NPT or Unplated Brass products



XFF Range 28



EJB Range 126



GUV Range 120



XEL Range 32

Related Products



Hex Head Ex e Stopping Plug / Dome Head Ex e & Nylon Stopping Plug

Ex e & nylon stopping plugs



Approvals / Characteristics



Features

- For use in potentially explosive atmospheres
- Hex Head and Dome Head stopping plugs manufactured from either Brass, Nickel Plated Brass or Stainless Steel
- Nylon Stopping Plug manufactured in Nylon only

Certification & Standards

Hex Head Exe Stopping Plug & Dome Head Stopping Plug
EC TYPE Examination Certificate:
ATEX: Baseefa 08 ATEX 0325X
IECEX: IECEX BAS08.0108X
GOST R: POCC GB.ГБ05.В03850
INMETRO: TÜV 11.0090
UL 1203 (Nickel Plated Brass and Stainless Steel only)
Ex e I Mb
Ex e IIC Gb
Ex tb IIIC Db
Temperature: -60°C to +80°C



Hex Head Exe Stopping Plug

Technical Specifications

Nickel Plated Type - Metric	Thread Size Metric (mm)	Brass Type - Metric	Thread Size Metric (mm)	Stainless Steel Type - Metric	Thread Size Metric (mm)
EXN/M16/HSP	16	EX/M16/HSP	16	EXS/M16/HSP	16
EXN/M20/HSP	20	EX/M20/HSP	20	EXS/M20/HSP	20
EXN/M25/HSP	25	EX/M25/HSP	25	EXS/M25/HSP	25
EXN/M32/HSP	32	EX/M32/HSP	32	EXS/M32/HSP	32
EXN/M40/HSP	40	EX/M40/HSP	40	EXS/M40/HSP	40
EXN/M50/HSP	50	EX/M50/HSP	50	EXS/M50/HSP	50
EXN/M63/HSP	63	EX/M63/HSP	63	EXS/M63/HSP	63

*Does not include M16 & 3/8 NPT or Unplated Brass products



Dome Head Exe Stopping Plug

Nickel Plated Type - Metric	Thread Size Metric (mm)	Brass Type - Metric	Thread Size Metric (mm)	Stainless Steel Type - Metric	Thread Size Metric (mm)
EXN/M16/DSP	16	EX/M16/DSP	16	EXS/M16/DSP	16
EXN/M20/DSP	20	EX/M20/DSP	20	EXS/M20/DSP	20
EXN/M25/DSP	25	EX/M25/DSP	25	EXS/M25/DSP	25
EXN/M32/DSP	32	EX/M32/DSP	32	EXS/M32/DSP	32
EXN/M40/DSP	40	EX/M40/DSP	40	EXS/M40/DSP	40
EXN/M50/DSP	50	EX/M50/DSP	50	EXS/M50/DSP	50
EXN/M63/DSP	63	EX/M63/DSP	63	EXS/M63/DSP	63

*Does not include M16 & 3/8 NPT or Unplated Brass products



Nylon Stopping Plug



Nylon Type - Metric	Thread Size Metric (mm)
EX-M16	16
EX-M20	20
EX-M25	25
EX-M32	32
EX-M40	40
EX-M50	50
EX-M63	63

*Supplied with Locknut

Certification & Standards

Nylon Stopping Plug
EC TYPE Examination Certificate:
IMQ 13 ATEX 016X, IECEx IMQ 13.0005X
Exe IIC Gb
Ex tb III Db
IP test: IP66-IP68



XFF Range 28



XB Range 112



GUV Range 120



EVS Range 42

Related Products

Accessories

Technical Specifications



Coupler - Female to Female thread couplers for use in both Exd and Exe applications



Nickel Plated Type - Metric	Thread Size Metric (mm)	Brass Type - Metric	Thread Size Metric (mm)	Stainless Steel Type - Metric	Thread Size Metric (mm)
EXN/M16/C	16	EX/M16/C	16	EXS/M16/C	16
EXN/M20/C	20	EX/M20/C	20	EXS/M20/C	20
EXN/M25/C	25	EX/M25/C	25	EXS/M25/C	25
EXN/M32/C	32	EX/M32/C	32	EXS/M32/C	32
EXN/M40/C	40	EX/M40/C	40	EXS/M40/C	40
EXN/M50/C	50	EX/M50/C	50	EXS/M50/C	50
EXN/M63/C	63	EX/M63/C	63	EXS/M63/C	63
EXN/M75/C	75	EX/M75/C	75	EXS/M75/C	75

Nickel Plated Type - NPT	Thread Size NPT (inch)	Brass Type - NPT	Thread Size NPT (inch)	Stainless Steel Type - NPT	Thread Size NPT (inch)
EXN/038/C	3/8	EX/038/C	3/8	EXS/038/C	3/8
EXN/050/C	1/2	EX/050/C	1/2	EXS/050/C	1/2
EXN/075/C	3/4	EX/075/C	3/4	EXS/075/C	3/4
EXN/100/C	1	EX/100/C	1	EXS/100/C	1
EXN/125/C	1 1/4	EX/125/C	1 1/4	EXS/125/C	1 1/4
EXN/150/C	1 1/2	EX/150/C	1 1/2	EXS/150/C	1 1/2
EXN/200/C	2	EX/200/C	2	EXS/200/C	2
EXN/250/C	2 1/2	EX/250/C	2 1/2	EXS/250/C	2 1/2

*Does not include M16 & 3/8 NPT or Unplated Brass products

Certification Standard: Baseefa 08 ATEX 0359U
IECEX BAS08.0121U
TÜV11.0158U

Ex de IIC Gb
Ex tb IIIC Db

Temperature: -60°C to +200°C



Hex Locknut

Nickel Plated Type - Metric	Thread Size Metric (mm)	Nickel Plated Type - NPT	Thread Size NPT (inch)
WHMM03	16	-	3/8
WHMM04	20	WHAM04	1/2
WHMM05	25	WHAM05	3/4
WHMM06	32	WHAM06	1
WHMM07	40	WHAM07	1 1/4
WHMM08	50	WHAM08	1 1/2
WHMM09	63	WHAM09	2

Stainless Steel Type - Metric	Thread Size Metric (mm)	Brass Type - Metric	Thread Size Metric (mm)
-	16	WHMB03	16
MXWH04	20	WHMB04	20
MXWH05	25	WHMB05	25
MXWH06	32	WHMB06	32
MXWH07	40	WHMB07	40
MXWH08	50	WHMB08	50
-	63	-	63



Technical Specifications

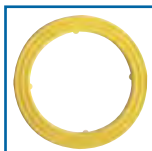

Sealing Joint Washer - for use with all ATEX and IECEx approved products (Nylon only)

Nylon Type - Metric	Thread Size Metric (mm)	Outside Diameter (mm)	Thickness (mm)	Fibre Type - Metric	Thread Size Metric (mm)	Outside Diameter (mm)	Thickness (mm)
EXFM03*	16	22	1.6	EXFM03F	16	22	1.6
EXFM04*	20	26	1.6	EXFM04F	20	26	1.6
EXFM05*	25	34.3	1.7	EXFM05F	25	34.3	1.7
EXFM06*	32	41.5	1.7	EXFM06F	32	41.5	1.7
EXFM07*	40	52	2	EXFM07F	40	52	2
EXFM08*	50	66.5	2	EXFM08F	50	66.5	2
EXFM09*	63	84.5	2				

Certification Standard: Nylon Metric approved for use with all ATEX / IECEx product



Earth Tag - to be used to create an earthing bond on an enclosure, when a cable gland is used

Brass Type - Metric	Thread Size Metric (mm)
EX/M16/TAG	16
EX/M20/TAG	20
EX/M25/TAG	25
EX/M32/TAG	32
EX/M40/TAG	40
EX/M50/TAG	50
EX/M63/TAG	63
EX/M75/TAG	75

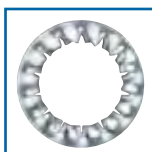

Serrated Washer

Steel Type - Metric	Thread Size Metric (mm)
EX/M16/SER	16
EX/M20/SER	20
EX/M25/SER	25
EX/M32/SER	32
EX/M40/SER	40
EX/M53/SER	50
EX/M63/SER	63
EX/M75/SER	75



EFDC Range 122



GUV Range 120



XB100 Range 104



EVS Range 42

Related Products

Index

Part No.	Page	Part No.	Page	Part No.	Page	Part No.	Page	Part No.	Page
621201	56	BEYR-121010	145	EFDC36	123	EVD120-DOJO	47	EVS220EME-C000	59
621500	56	BEYR-171212	145	EFDC37	123	EVD120EM-00JO	65	EVS240-0000	43
4GRA00001S	93	BEYR-231717	145	EFDC38	123	EVD120EM-DOJO	65	EVS240-D000	43
4GRA00002S	92	BEYR-292323	145	EFDC39	123	EVD140-00JO	47	EVS240EM-0000	59
4GRA00002S	93	BEYR-362929	145	EFDC40	123	EVD140-DOJO	47	EVS240EMA-D000	61
4GRA00002S	94	BEYR-483636	145	EFDC41	123	EVD140EM-00JO	65	EVS240EM-C000	59
B001	93	BP02	132	EFDC42	123	EVD140EM-DOJO	65	EVS265-0000	43
B001	94	BP03	132	EFDC43	123	EVD165-00JO	47	EVS265-D000	43
B002	93	BP04	132	EFDC44	123	EVD165-DOJO	47	EVT120-A0JO	77
B004	94	BP05	132	EJB0	127	EVD220-00JO	47	EVT120-DOJO	77
B005B	94	BP05V	132	EJB1	127	EVD220-DOJO	47	EVT120EM-00JO	87
B006L	94	BPN10	132	EJB11	127	EVD220EM-00JO	65	EVT120EM-DOJO	87
B007	94	BPR10	132	EJB11-V1	131	EVD220EM-DOJO	65	EVT140-A0JO	77
B008B	94	BPV10	132	EJB11-V2	131	EVD240-00JO	47	EVT140-DOJO	77
B008C	94	D001	92	EJB12	127	EVD240-DOJO	47	EVT140EM-00JO	87
B009	94	D001	94	EJB13	127	EVD240EM-00JO	65	EVT140EM-DOJO	87
B009A	94	D002	92	EJB13-V1	131	EVD240EM-DOJO	65	EVT165-A0JO	77
B010B	94	D002	93	EJB13-V2	131	EVD265-00JO	47	EVT165-DOJO	77
B013	94	D002EM	94	EJB2	127	EVD265-DOJO	47	EVT220-A0JO	77
B013K	94	D005	92	EJB2-V1	131	EVN120-0000	45	EVT220-DOJO	77
B014B	94	D005	94	EJB2-V2	131	EVN120-D000	45	EVT220EM-00JO	87
B015	94	D010	92	EJB2-V3	131	EVN120EM-0000	63	EVT220EM-DOJO	87
BCP30	132	D010	93	EJB2-V4	131	EVN120EM-D000	63	EVT240-A0JO	77
BCP40	132	D010	94	EJB4	127	EVN140-0000	45	EVT240EM-00JO	87
BCP50	132	D016	94	EJB4-V1	131	EVN140-D000	45	EVT240EM-DOJO	87
BEAVR-12/10	146	D021C	92	EJB4-V2	131	EVN140EM-0000	63	EVT265-A0JO	77
BEAVR-17/12	146	D021C	93	EJB4-V3	131	EVN140EM-D000	63	EVX100-00000	98
BEAVR-23/17	146	D021C	94	EJB4-V5	131	EVN165-0000	45	EVX200-00000	98
BEAVR-29/23	146	D022	92	EJB4-V6	131	EVN165-D000	45	EVX300-00000	98
BEAVR-36/29	146	D022	93	EJB5	127	EVN220-0000	45	EVXIm40-00000	103
BEAVR-48/36	146	D022	94	EJB8	127	EVN220-D000	45	EVXIm50-00000	103
BEH-10-0	147	D023	90	EJB8-V1	131	EVN220EM-0000	63	EVXna20-00000	99
BEH-12-0	147	D024	90	EJB8-V2	131	EVN220EM-D000	63	EVXna30-00000	99
BEH-17-0	147	D025	90	EJB8-V3	131	EVN240-0000	45	EVXna40-00000	99
BEH-23-0	147	D026	90	EL120-0G000	73	EVN240-D000	45	EVXna50-00000	99
BEH-29-0	147	D027	90	EL220-0G000	73	EVN240EM-0000	63	EX/038/SP	175
BEH-36-0	147	DE01	132	EL30011-0G000	73	EVN240EM-D000	63	EX/038/TSP	175
BEH-48-0	147	DE02	132	EL30028-0G000	73	EVN265-0000	45	EX/038-M16/TC	171
BENR-REM162-24	146	DE03	132	EL3008-0G000	73	EVS120-0000	43	EX/050/SP	175
BENR-REM207-28	146	DE04	132	EL3009-0G000	73	EVS120-D000	43	EX/050/TSP	175
BENR-REM253-32	146	DE05	132	ESB220-0000	49	EVS120EMA-0000	61	EX/050-075/E	172
BENR-REM329-44	146	DE10	132	ESB220-A000	49	EVS120EMA-D000	61	EX/050-M16/TC	171
BENR-REM406-50	146	E007	93	ESB240-0000	49	EVS120EME-0000	59	EX/050-M20/TC	171
BENR-REM508-65	146	E008C	93	ESB240-A000	49	EVS120EME-C000	59	EX/050-M25/TC	171
BESGR-1212	145	EF110G-00000	75	ESB240EM-0000	67	EVS140-0000	43	EX/050-PG11/TC	173
BESGR-1212	145	EF110P-00000	75	ESB240EM-A000	67	EVS140-D000	43	EX/050-PG13/TC	173
BESGR-1212	145	EF140G-00000	75	ESB265-0000	49	EVS140EM-0000	59	EX/050-PG16/TC	173
BESGR-1212	145	EF140P-00000	75	ESB265-A000	49	EVS140EMA-0000	61	EX/050-PG9/TC	173
BESGR-1212	145	EFDC21	123	EST220-00JO	79	EVS140EMA-D000	61	EX/075/SP	175
BESGR-1212	145	EFDC21F	123	EST220-A0JO	79	EVS140EM-C000	59	EX/075/TSP	175
BETR-101010	145	EFDC21G	123	EST240-00JO	79	EVS165-0000	43	EX/075-050/R	172
BETR-121212	145	EFDC21P	123	EST240-A0JO	79	EVS165-D000	43	EX/075-100/E	172
BETR-171717	145	EFDC21V	123	EST240EM-00JO	89	EVS220-0000	43	EX/075-M16/TC	171
BETR-232323	145	EFDC22	123	EST240EM-A0JO	89	EVS220-D000	43	EX/075-M20/TC	171
BETR-292929	145	EFDC23	123	EST265-00JO	79	EVS220EMA-0000	61	EX/075-M25/TC	171
BETR-363636	145	EFDC24	123	EST265-A0JO	79	EVS220EMA-D000	61	EX/075-M32/TC	171
BETR-363636	145	EFDC25	123	EVD120-00JO	47	EVS220EME-0000	59	EX/075-PG11/TC	173

Part No.	Page	Part No.	Page	Part No.	Page	Part No.	Page	Part No.	Page
EX/075-PG13/TC	173	EX/150-PG29/TC	173	EX/M20-PG16/TC	173	EX/M40-M25/R	171	EX/M63-M50/R	171
EX/075-PG16/TC	173	EX/150-PG36/TC	173	EX/M20-PG9/TC	173	EX/M40-M32/R	171	EX/M63-M75/E	171
EX/075-PG21/TC	173	EX/150-PG42/TC	173	EX/M25/C	178	EX/M40-M50/E	171	EX/M63-PG11/TC	173
EX/075-PG9/TC	173	EX/150-PG9/TC	173	EX/M25/DSP	177	EX/M40-M63/E	171	EX/M63-PG13/TC	173
EX/100/SP	175	EX/200/SP	175	EX/M25/HSP	177	EX/M40-PG11/TC	173	EX/M63-PG16/TC	173
EX/100/TS/SP	175	EX/200/TS/SP	175	EX/M25/SER	179	EX/M40-PG13/TC	173	EX/M63-PG21/TC	173
EX/100-050/R	172	EX/200-050/R	172	EX/M25/SP	175	EX/M40-PG16/TC	173	EX/M63-PG29/TC	173
EX/100-075/R	172	EX/200-075/R	172	EX/M25/TAG	179	EX/M40-PG21/TC	173	EX/M63-PG36/TC	173
EX/100-125/E	172	EX/200-100/R	172	EX/M25/TSP	175	EX/M40-PG29/TC	173	EX/M63-PG42/TC	173
EX/100-M16/TC	171	EX/200-125/R	172	EX/M25-050/TC	172	EX/M40-PG36/TC	173	EX/M63-PG48/TC	173
EX/100-M20/TC	171	EX/200-150/R	172	EX/M25-075/TC	172	EX/M40-PG9/TC	173	EX/M63-PG9/TC	173
EX/100-M25/TC	171	EX/200-M16/TC	171	EX/M25-100/TC	172	EX/M50/C	178	EX/M75/C	178
EX/100-M32/TC	171	EX/200-M20/TC	171	EX/M25-M16/R	171	EX/M50/DSP	177	EX/M75/SER	179
EX/100-M40/TC	171	EX/200-M25/TC	171	EX/M25-M20/R	171	EX/M50/HSP	177	EX/M75/TAG	179
EX/100-PG11/TC	173	EX/200-M32/TC	171	EX/M25-M32/E	171	EX/M50/SER	179	EX/M75-050/TC	172
EX/100-PG13/TC	173	EX/200-M40/TC	171	EX/M25-M40/E	171	EX/M50/SP	175	EX/M75-075/TC	172
EX/100-PG16/TC	173	EX/200-M50/TC	171	EX/M25-PG11/TC	173	EX/M50/TAG	179	EX/M75-100/TC	172
EX/100-PG21/TC	173	EX/200-M63/TC	171	EX/M25-PG13/TC	173	EX/M50/TSP	175	EX/M75-125/TC	172
EX/100-PG29/TC	173	EX/200-PG11/TC	173	EX/M25-PG16/TC	173	EX/M50-050/TC	172	EX/M75-150/TC	172
EX/100-PG9/TC	173	EX/200-PG13/TC	173	EX/M25-PG21/TC	173	EX/M50-075/TC	172	EX/M75-200/TC	172
EX/125/SP	175	EX/200-PG16/TC	173	EX/M25-PG9/TC	173	EX/M50-100/TC	172	EX/M75-M16/R	171
EX/125/TS/SP	175	EX/200-PG21/TC	173	EX/M32/C	178	EX/M50-125/TC	172	EX/M75-M20/R	171
EX/125-050/R	172	EX/200-PG29/TC	173	EX/M32/DSP	177	EX/M50-150/TC	172	EX/M75-M25/R	171
EX/125-075/R	172	EX/200-PG36/TC	173	EX/M32/HSP	177	EX/M50-200/TC	172	EX/M75-M32/R	171
EX/125-100/R	172	EX/200-PG42/TC	173	EX/M32/SER	179	EX/M50-M16/R	171	EX/M75-M40/R	171
EX/125-150/E	172	EX/200-PG48/TC	173	EX/M32/SP	175	EX/M50-M20/R	171	EX/M75-M50/R	171
EX/125-M16/TC	171	EX/200-PG9/TC	173	EX/M32/TAG	179	EX/M50-M25/R	171	EX/M75-M63/R	171
EX/125-M20/TC	171	EX/250-M50/TC	171	EX/M32/TSP	175	EX/M50-M32/R	171	EX/M75-PG11/TC	173
EX/125-M25/TC	171	EX/300-M50/TC	171	EX/M32-050/TC	172	EX/M50-M40/R	171	EX/M75-PG13/TC	173
EX/125-M32/TC	171	EX/M16/C	178	EX/M32-075/TC	172	EX/M50-M63/E	171	EX/M75-PG16/TC	173
EX/125-M40/TC	171	EX/M16/DSP	177	EX/M32-100/TC	172	EX/M50-M75/E	171	EX/M75-PG21/TC	173
EX/125-M50/TC	171	EX/M16/HSP	177	EX/M32-125/TC	172	EX/M50-PG11/TC	173	EX/M75-PG29/TC	173
EX/125-PG11/TC	173	EX/M16/SER	179	EX/M32-M16/R	171	EX/M50-PG13/TC	173	EX/M75-PG36/TC	173
EX/125-PG13/TC	173	EX/M16/SP	175	EX/M32-M20/R	171	EX/M50-PG16/TC	173	EX/M75-PG42/TC	173
EX/125-PG16/TC	173	EX/M16/TAG	179	EX/M32-M25/R	171	EX/M50-PG21/TC	173	EX/M75-PG48/TC	173
EX/125-PG21/TC	173	EX/M16/TSP	175	EX/M32-M40/E	171	EX/M50-PG29/TC	173	EX/M75-PG9/TC	173
EX/125-PG29/TC	173	EX/M16-038/TC	172	EX/M32-M50/E	171	EX/M50-PG36/TC	173	EX/PG11/DSP	177
EX/125-PG36/TC	173	EX/M16-050/TC	172	EX/M32-PG11/TC	173	EX/M50-PG42/TC	173	EX/PG11/HSP	177
EX/125-PG9/TC	173	EX/M16-M20/E	171	EX/M32-PG13/TC	173	EX/M50-PG9/TC	173	EX/PG11/SP	175
EX/150/SP	175	EX/M16-M25/E	171	EX/M32-PG16/TC	173	EX/M63/C	178	EX/PG11/TS/SP	175
EX/150/TS/SP	175	EX/M16-PG11/TC	173	EX/M32-PG21/TC	173	EX/M63/DSP	177	EX/PG11-050/TC	172
EX/150-050/R	172	EX/M16-PG13/TC	173	EX/M32-PG29/TC	173	EX/M63/HSP	177	EX/PG11-M16/TC	171
EX/150-075/R	172	EX/M16-PG9/TC	173	EX/M32-PG9/TC	173	EX/M63/SER	179	EX/PG11-M20/TC	171
EX/150-100/R	172	EX/M20/C	178	EX/M40/C	178	EX/M63/SP	175	EX/PG11-PG9/R	173
EX/150-125/R	172	EX/M20/DSP	177	EX/M40/DSP	177	EX/M63/TAG	179	EX/PG13/DSP	177
EX/150-200/E	172	EX/M20/HSP	177	EX/M40/HSP	177	EX/M63/TSP	175	EX/PG13/HSP	177
EX/150-M16/TC	171	EX/M20/SER	179	EX/M40/SER	179	EX/M63-050/TC	172	EX/PG13/SP	175
EX/150-M20/TC	171	EX/M20/SP	175	EX/M40/SP	175	EX/M63-075/TC	172	EX/PG13/TS/SP	175
EX/150-M25/TC	171	EX/M20/TAG	179	EX/M40/TAG	179	EX/M63-100/TC	172	EX/PG13-050/TC	172
EX/150-M32/TC	171	EX/M20/TSP	175	EX/M40/TSP	175	EX/M63-125/TC	172	EX/PG13-M16/TC	171
EX/150-M40/TC	171	EX/M20-050/TC	172	EX/M40-050/TC	172	EX/M63-150/TC	172	EX/PG13-M20/TC	171
EX/150-M50/TC	171	EX/M20-075/TC	172	EX/M40-075/TC	172	EX/M63-200/TC	172	EX/PG13-PG11/R	173
EX/150-M63/TC	171	EX/M20-M16/R	171	EX/M40-100/TC	172	EX/M63-M16/R	171	EX/PG13-PG9/R	173
EX/150-PG11/TC	173	EX/M20-M25/E	171	EX/M40-125/TC	172	EX/M63-M20/R	171	EX/PG16/DSP	177
EX/150-PG13/TC	173	EX/M20-M32/E	171	EX/M40-150/TC	172	EX/M63-M25/R	171	EX/PG16/HSP	177
EX/150-PG16/TC	173	EX/M20-PG11/TC	173	EX/M40-M16/R	171	EX/M63-M32/R	171	EX/PG16/SP	175
EX/150-PG21/TC	173	EX/M20-PG13/TC	173	EX/M40-M20/R	171	EX/M63-M40/R	171	EX/PG16/TS/SP	175

Index

Part No.	Page	Part No.	Page	Part No.	Page	Part No.	Page	Part No.	Page
EX/PG16-050/TC	172	EX/PG36-M40/TC	171	EX/PG48-PG42/R	173	EX06AMC3	165	EX11MLC3	165
EX/PG16-075/TC	172	EX/PG36-M50/TC	171	EX/PG48-PG9/R	173	EX06ASC1	163	EX11MMC1	163
EX/PG16-M16/TC	171	EX/PG36-PG11/R	173	EX/PG9/DSP	177	EX06ASC3	165	EX11MSC1	163
EX/PG16-M20/TC	171	EX/PG36-PG13/R	173	EX/PG9/HSP	177	EX06MLC2	167	EX12ALC2	167
EX/PG16-M25/TC	171	EX/PG36-PG16/R	173	EX/PG9/SP	175	EX06MLC3	165	EX12AMC1	163
EX/PG16-PG11/R	173	EX/PG36-PG21/R	173	EX/PG9/TSP	175	EX06MMC1	163	EX12AMC2	167
EX/PG16-PG13/R	173	EX/PG36-PG29/R	173	EX/PG9-050/TC	172	EX06MMC2	167	EX12MLC2	167
EX/PG16-PG21/E	173	EX/PG36-PG48/E	173	EX/PG9-M16/TC	171	EX06MMC3	165	EX12MMC1	163
EX/PG16-PG9/R	173	EX/PG36-PG9/R	173	EX/PG9-M20/TC	171	EX06MSC1	163	EX12MMC2	167
EX/PG21/DSP	177	EX/PG42/DSP	177	EX02AMC3	165	EX06MSC3	165	EX13AMC2	167
EX/PG21/HSP	177	EX/PG42/HSP	177	EX02MMC3	165	EX07ALC2	167	EX13MMC2	167
EX/PG21/SP	175	EX/PG42/SP	175	EX03ALC3	165	EX07AM3	165	EX14AMC1	163
EX/PG21/TSP	175	EX/PG42/TSP	175	EX03ALC1	163	EX07AMC1	163	EX14AMC2	167
EX/PG21-075/TC	172	EX/PG42-050/TC	172	EX03AMC2	167	EX07AMC2	167	EX14MMC1	163
EX/PG21-100/TC	172	EX/PG42-075/TC	172	EX03AMC3	165	EX07ASC1	163	EX14MMC2	167
EX/PG21-M16/TC	171	EX/PG42-100/TC	172	EX03ASC1	163	EX07MLC2	167	EXB0310	138
EX/PG21-M20/TC	171	EX/PG42-125/TC	172	EX03MLC3	165	EX07MM3	165	EXB0330	138
EX/PG21-M25/TC	171	EX/PG42-150/TC	172	EX03MMC1	163	EX07MMC1	163	EXB0350	138
EX/PG21-M32/TC	171	EX/PG42-200/TC	172	EX03MMC2	167	EX07MMC2	167	EXB0410	138
EX/PG21-PG11/R	173	EX/PG42-M16/TC	171	EX03MMC3	165	EX07MSC1	163	EXB0430	138
EX/PG21-PG13/R	173	EX/PG42-M20/TC	171	EX03MSC1	163	EX08ALC2	167	EXB0450	138
EX/PG21-PG16/R	173	EX/PG42-M25/TC	171	EX04ALC2	167	EX08ALC3	165	EXB0510	138
EX/PG21-PG29/E	173	EX/PG42-M32/TC	171	EX04ALC3	165	EX08AMC1	163	EXB0530	138
EX/PG21-PG9/R	173	EX/PG42-M40/TC	171	EX04AMC1	163	EX08AMC2	167	EXB0550	138
EX/PG29/DSP	177	EX/PG42-M50/TC	171	EX04AMC2	167	EX08AMC3	165	EXB0610	138
EX/PG29/HSP	177	EX/PG42-M63/TC	171	EX04AMC3	165	EX08ASC1	163	EXB0630	138
EX/PG29/SP	175	EX/PG42-PG11/R	173	EX04ASC1	163	EX08MLC2	167	EXB0650	138
EX/PG29/TSP	175	EX/PG42-PG13/R	173	EX04ASC3	165	EX08MLC3	165	EXB0710	138
EX/PG29-050/TC	172	EX/PG42-PG16/R	173	EX04MLC1	163	EX08MMC1	163	EXB0730	138
EX/PG29-075/TC	172	EX/PG42-PG21/R	173	EX04MLC1	163	EX08MMC2	167	EXB0750	138
EX/PG29-100/TC	172	EX/PG42-PG29/R	173	EX04MLC2	167	EX08MMC3	165	EXB0810	138
EX/PG29-125/TC	172	EX/PG42-PG36/R	173	EX04MLC3	165	EX08MSC1	163	EXB0830	138
EX/PG29-150/TC	172	EX/PG42-PG48/E	173	EX04MMC1	163	EX09ALC2	167	EXB0850	138
EX/PG29-M16/TC	171	EX/PG42-PG9/R	173	EX04MMC2	167	EX09ALC3	165	EXBB0310	138
EX/PG29-M20/TC	171	EX/PG48/DSP	177	EX04MMC3	165	EX09AMC1	163	EXBB0410	138
EX/PG29-M25/TC	171	EX/PG48/HSP	177	EX04MSC1	163	EX09AMC2	167	EXBB0430	138
EX/PG29-M32/TC	171	EX/PG48/SP	175	EX04MSC3	165	EX09AMC3	165	EXBB0450	138
EX/PG29-M40/TC	171	EX/PG48/TSP	175	EX05ALC2	167	EX09ASC1	163	EXBB0510	138
EX/PG29-PG11/R	173	EX/PG48-050/TC	172	EX05ALC3	165	EX09MLC2	167	EXBB0530	138
EX/PG29-PG13/R	173	EX/PG48-075/TC	172	EX05AMC1	163	EX09MLC3	165	EXBB0550	138
EX/PG29-PG16/R	173	EX/PG48-100/TC	172	EX05AMC2	167	EX09MMC1	163	EXBB0610	138
EX/PG29-PG21/R	173	EX/PG48-125/TC	172	EX05AMC3	165	EX09MMC2	167	EXBB0630	138
EX/PG29-PG36/E	173	EX/PG48-150/TC	172	EX05ASC1	163	EX09MMC3	165	EXBB0650	138
EX/PG29-PG9/R	173	EX/PG48-200/TC	172	EX05ASC3	165	EX09MSC1	163	EXBB0710	138
EX/PG36/DSP	177	EX/PG48-M16/TC	171	EX05MLC1	163	EX10ALC2	167	EXBB0810	138
EX/PG36/HSP	177	EX/PG48-M20/TC	171	EX05MLC1	163	EX10AMC1	163	EXBBT0110	148
EX/PG36/SP	175	EX/PG48-M25/TC	171	EX05MLC2	167	EX10AMC2	167	EXBBT0130	148
EX/PG36/TSP	175	EX/PG48-M32/TC	171	EX05MLC3	165	EX10AMC3	165	EXBBT0210	148
EX/PG36-050/TC	172	EX/PG48-M40/TC	171	EX05MMC1	163	EX10MLC2	167	EXBBT0230	148
EX/PG36-075/TC	172	EX/PG48-M50/TC	171	EX05MMC2	167	EX10MMC1	163	EXBBT0310	148
EX/PG36-100/TC	172	EX/PG48-M63/TC	171	EX05MMC3	165	EX10MMC2	167	EXBBT0330	148
EX/PG36-125/TC	172	EX/PG48-PG11/R	173	EX05MSC1	163	EX10MMC3	165	EXBBT0410	148
EX/PG36-150/TC	172	EX/PG48-PG13/R	173	EX05MSC3	165	EX10MSC1	163	EXBBT0430	148
EX/PG36-M16/TC	171	EX/PG48-PG16/R	173	EX06ALC2	167	EX10MSC1	163	EXBBT0450	148
EX/PG36-M20/TC	171	EX/PG48-PG21/R	173	EX06ALC3	165	EX11ALC3	165	EXBBT0510	148
EX/PG36-M25/TC	171	EX/PG48-PG29/R	173	EX06AMC1	163	EX11AMC1	163	EXBBT0530	148
EX/PG36-M32/TC	171	EX/PG48-PG36/R	173	EX06AMC2	167	EX11ASC1	163	EXBBT0550	148

Part No.	Page	Part No.	Page	Part No.	Page	Part No.	Page	Part No.	Page
EXBBT0610	148	EXLB0410	148	EXLT0430	150	EXN/100-PG16/TC	173	EXN/200-M50/TC	171
EXBBT0630	148	EXLB0430	148	EXLT0510	150	EXN/100-PG21/TC	173	EXN/200-M63/TC	171
EXBBT0710	148	EXLB0450	148	EXLT0530	150	EXN/100-PG29/TC	173	EXN/200-PG11/TC	173
EXBBT0720	148	EXLB0510	148	EXLT0610	150	EXN/100-PG9/TC	173	EXN/200-PG13/TC	173
EXBBT0810	148	EXLB0530	148	EXLT0620	150	EXN/125/SP	175	EXN/200-PG16/TC	173
EXBBT0820	148	EXLB0550	148	EXLT0710	150	EXN/125/TSP	175	EXN/200-PG21/TC	173
EXBBT0910	148	EXLB0610	148	EXLT0720	150	EXN/125-050/R	172	EXN/200-PG29/TC	173
EXBBT0920	148	EXLB0630	148	EXLT0810	150	EXN/125-075/R	172	EXN/200-PG36/TC	173
EXBQA0304	141	EXLB0710	148	EXLT0820	150	EXN/125-100/R	172	EXN/200-PG42/TC	173
EXBQA0404	141	EXLB0720	148	EXLT0910	150	EXN/125-150/E	172	EXN/200-PG48/TC	173
EXBQA0505	141	EXLB0810	148	EXLT0920	150	EXN/125-M16/TC	171	EXN/250-PG9/TC	173
EXBQA0606	141	EXLB0820	148	EXLT0930	150	EXN/125-M20/TC	171	EXN/250-M50/TC	171
EXBQA0707	141	EXLB0910	148	EX-M16	177	EXN/125-M25/TC	171	EXN/300-M50/TC	171
EXBQA0808	141	EXLB0920	148	EX-M20	177	EXN/125-M32/TC	171	EXN/M16/C	178
EXBQM0303	141	EXLH0310	149	EX-M25	177	EXN/125-M40/TC	171	EXN/M16/DSP	177
EXBQM0404	141	EXLH0330	149	EX-M32	177	EXN/125-M50/TC	171	EXN/M16/HSP	177
EXBQM0505	141	EXLH0410	149	EX-M40	177	EXN/125-PG11/TC	173	EXN/M16/SP	175
EXBQM0606	141	EXLH0430	149	EX-M50	177	EXN/125-PG13/TC	173	EXN/M16/TSP	175
EXBQM0707	141	EXLH0510	149	EX-M63	177	EXN/125-PG16/TC	173	EXN/M16-038/TC	172
EXBQM0808	141	EXLH0530	149	EXN/038/SP	175	EXN/125-PG21/TC	173	EXN/M16-050/TC	172
EXCG050M	179	EXLH0610	149	EXN/038/TSP	175	EXN/125-PG29/TC	173	EXN/M16-M20/E	171
EXCG050S	179	EXLH0620	149	EXN/038-M16/TC	171	EXN/125-PG36/TC	173	EXN/M16-M25/E	171
EXCG075S	179	EXLH0710	149	EXN/050/SP	175	EXN/125-PG9/TC	173	EXN/M16-PG11/TC	173
EXCG100S	179	EXLH0720	149	EXN/050/TSP	175	EXN/150/SP	175	EXN/M16-PG13/TC	173
EXCGM16S	179	EXLH0810	149	EXN/050-075/E	172	EXN/150/TSP	175	EXN/M16-PG9/TC	173
EXCGM16SL	179	EXLH0820	149	EXN/050-M16/TC	171	EXN/150-050/R	172	EXN/M20/C	178
EXCGM20M	179	EXLH0910	149	EXN/050-M20/TC	171	EXN/150-075/R	172	EXN/M20/DSP	177
EXCGM20ML	179	EXLH0920	149	EXN/050-M25/TC	171	EXN/150-100/R	172	EXN/M20/HSP	177
EXCGM20S	179	EXLHC0310	149	EXN/050-PG11/TC	173	EXN/150-125/R	172	EXN/M20/SP	175
EXCGM20S	179	EXLHC0330	149	EXN/050-PG13/TC	173	EXN/150-200/E	172	EXN/M20/TSP	175
EXCGM20SL	179	EXLHC0410	149	EXN/050-PG16/TC	173	EXN/150-M16/TC	171	EXN/M20-050/TC	172
EXCGM25M	179	EXLHC0430	149	EXN/050-PG9/TC	173	EXN/150-M20/TC	171	EXN/M20-075/TC	172
EXCGM25SL	179	EXLHC0510	149	EXN/075/SP	175	EXN/150-M25/TC	171	EXN/M20-M16/R	171
EXCGM32S	179	EXLHC0530	149	EXN/075/TSP	175	EXN/150-M32/TC	171	EXN/M20-M25/E	171
EXCGM32SL	179	EXLHC0610	149	EXN/075-050/R	172	EXN/150-M40/TC	171	EXN/M20-M32/E	171
EXCGM40M	179	EXLHC0630	149	EXN/075-100/E	172	EXN/150-M50/TC	171	EXN/M20-PG11/TC	173
EXCGM40S	179	EXLHC0710	149	EXN/075-M16/TC	171	EXN/150-M63/TC	171	EXN/M20-PG13/TC	173
EXCGM50S	179	EXLHC0810	149	EXN/075-M20/TC	171	EXN/150-PG11/TC	173	EXN/M20-PG16/TC	173
EXCGM63S	179	EXLHC0820	149	EXN/075-M25/TC	171	EXN/150-PG13/TC	173	EXN/M20-PG9/TC	173
EXFM03	179	EXLHC0910	149	EXN/075-M32/TC	171	EXN/150-PG16/TC	173	EXN/M25/C	178
EXFM03F	179	EXLLH0310	149	EXN/075-PG11/TC	173	EXN/150-PG21/TC	173	EXN/M25/DSP	177
EXFM04	179	EXLLH0330	149	EXN/075-PG13/TC	173	EXN/150-PG29/TC	173	EXN/M25/HSP	177
EXFM04F	179	EXLLH0410	149	EXN/075-PG16/TC	173	EXN/150-PG36/TC	173	EXN/M25/SP	175
EXFM05	179	EXLLH0430	149	EXN/075-PG21/TC	173	EXN/150-PG42/TC	173	EXN/M25/TSP	175
EXFM05F	179	EXLLH0510	149	EXN/075-PG9/TC	173	EXN/150-PG9/TC	173	EXN/M25-050/TC	172
EXFM06	179	EXLLH0530	149	EXN/100/SP	175	EXN/200/SP	175	EXN/M25-075/TC	172
EXFM06F	179	EXLLH0610	149	EXN/100/TSP	175	EXN/200/TSP	175	EXN/M25-100/TC	172
EXFM07	179	EXLLH0620	149	EXN/100-050/R	172	EXN/200-050/R	172	EXN/M25-M16/R	171
EXFM07F	179	EXLLH0710	149	EXN/100-075/R	172	EXN/200-075/R	172	EXN/M25-M20/R	171
EXFM08	179	EXLLH0720	149	EXN/100-125/E	172	EXN/200-100/R	172	EXN/M25-M32/E	171
EXFM08F	179	EXLLH0810	149	EXN/100-M16/TC	171	EXN/200-125/R	172	EXN/M25-M40/E	171
EXLB0110	148	EXLLH0820	149	EXN/100-M20/TC	171	EXN/200-150/R	172	EXN/M25-PG11/TC	173
EXLB0130	148	EXLLH0910	149	EXN/100-M25/TC	171	EXN/200-M16/TC	171	EXN/M25-PG13/TC	173
EXLB0210	148	EXLLH0920	149	EXN/100-M32/TC	171	EXN/200-M20/TC	171	EXN/M25-PG16/TC	173
EXLB0230	148	EXLT0310	150	EXN/100-M40/TC	171	EXN/200-M25/TC	171	EXN/M25-PG21/TC	173
EXLB0310	148	EXLT0330	150	EXN/100-PG11/TC	173	EXN/200-M32/TC	171	EXN/M25-PG9/TC	173
EXLB0330	148	EXLT0410	150	EXN/100-PG13/TC	173	EXN/200-M40/TC	171	EXN/M32/C	178

Index

Part No.	Page	Part No.	Page	Part No.	Page	Part No.	Page	Part No.	Page
EXN/M32/DSP	177	EXN/M50-M40/R	171	EXN/M75-PG42/TC	173	EXN/PG29-M16/TC	171	EXN/PG42-PG9/R	173
EXN/M32/HSP	177	EXN/M50-M63/E	171	EXN/M75-PG48/TC	173	EXN/PG29-M20/TC	171	EXN/PG48/DSP	177
EXN/M32/SP	175	EXN/M50-M75/E	171	EXN/M75-PG9/TC	173	EXN/PG29-M25/TC	171	EXN/PG48/HSP	177
EXN/M32/TSP	175	EXN/M50-PG11/TC	173	EXN/PG11/DSP	177	EXN/PG29-M32/TC	171	EXN/PG48/SP	175
EXN/M32-050/TC	172	EXN/M50-PG13/TC	173	EXN/PG11/HSP	177	EXN/PG29-M40/TC	171	EXN/PG48/TSP	175
EXN/M32-075/TC	172	EXN/M50-PG16/TC	173	EXN/PG11/SP	175	EXN/PG29-PG11/R	173	EXN/PG48-050/TC	172
EXN/M32-100/TC	172	EXN/M50-PG21/TC	173	EXN/PG11/TSP	175	EXN/PG29-PG13/R	173	EXN/PG48-075/TC	172
EXN/M32-125/TC	172	EXN/M50-PG29/TC	173	EXN/PG11-050/TC	172	EXN/PG29-PG16/R	173	EXN/PG48-100/TC	172
EXN/M32-M16/R	171	EXN/M50-PG36/TC	173	EXN/PG11-M16/TC	171	EXN/PG29-PG21/R	173	EXN/PG48-125/TC	172
EXN/M32-M20/R	171	EXN/M50-PG42/TC	173	EXN/PG11-M20/TC	171	EXN/PG29-PG36/E	173	EXN/PG48-150/TC	172
EXN/M32-M25/R	171	EXN/M50-PG9/TC	173	EXN/PG11-PG9/R	173	EXN/PG29-PG9/R	173	EXN/PG48-200/TC	172
EXN/M32-M40/E	171	EXN/M63/C	178	EXN/PG13/DSP	177	EXN/PG36/DSP	177	EXN/PG48-M16/TC	171
EXN/M32-M50/E	171	EXN/M63/DSP	177	EXN/PG13/HSP	177	EXN/PG36/HSP	177	EXN/PG48-M20/TC	171
EXN/M32-PG11/TC	173	EXN/M63/HSP	177	EXN/PG13/SP	175	EXN/PG36/SP	175	EXN/PG48-M25/TC	171
EXN/M32-PG13/TC	173	EXN/M63/SP	175	EXN/PG13/TSP	175	EXN/PG36/TSP	175	EXN/PG48-M32/TC	171
EXN/M32-PG16/TC	173	EXN/M63/TSP	175	EXN/PG13-050/TC	172	EXN/PG36-050/TC	172	EXN/PG48-M40/TC	171
EXN/M32-PG21/TC	173	EXN/M63-050/TC	172	EXN/PG13-M16/TC	171	EXN/PG36-075/TC	172	EXN/PG48-M50/TC	171
EXN/M32-PG29/TC	173	EXN/M63-075/TC	172	EXN/PG13-M20/TC	171	EXN/PG36-100/TC	172	EXN/PG48-M63/TC	171
EXN/M32-PG9/TC	173	EXN/M63-100/TC	172	EXN/PG13-PG11/R	173	EXN/PG36-125/TC	172	EXN/PG48-PG11/R	173
EXN/M40/C	178	EXN/M63-125/TC	172	EXN/PG13-PG9/R	173	EXN/PG36-150/TC	172	EXN/PG48-PG13/R	173
EXN/M40/DSP	177	EXN/M63-150/TC	172	EXN/PG16/DSP	177	EXN/PG36-M16/TC	171	EXN/PG48-PG16/R	173
EXN/M40/HSP	177	EXN/M63-200/TC	172	EXN/PG16/HSP	177	EXN/PG36-M20/TC	171	EXN/PG48-PG21/R	173
EXN/M40/SP	175	EXN/M63-M16/R	171	EXN/PG16/SP	175	EXN/PG36-M25/TC	171	EXN/PG48-PG29/R	173
EXN/M40/TSP	175	EXN/M63-M20/R	171	EXN/PG16/TSP	175	EXN/PG36-M32/TC	171	EXN/PG48-PG36/R	173
EXN/M40-050/TC	172	EXN/M63-M25/R	171	EXN/PG16-050/TC	172	EXN/PG36-M40/TC	171	EXN/PG48-PG42/R	173
EXN/M40-075/TC	172	EXN/M63-M32/R	171	EXN/PG16-075/TC	172	EXN/PG36-M50/TC	171	EXN/PG48-PG9/R	173
EXN/M40-100/TC	172	EXN/M63-M40/R	171	EXN/PG16-M16/TC	171	EXN/PG36-PG11/R	173	EXN/PG9/DSP	177
EXN/M40-125/TC	172	EXN/M63-M50/R	171	EXN/PG16-M20/TC	171	EXN/PG36-PG13/R	173	EXN/PG9/HSP	177
EXN/M40-150/TC	172	EXN/M63-M75/E	171	EXN/PG16-M25/TC	171	EXN/PG36-PG16/R	173	EXN/PG9/SP	175
EXN/M40-M16/R	171	EXN/M63-PG11/TC	173	EXN/PG16-PG11/R	173	EXN/PG36-PG21/R	173	EXN/PG9/TSP	175
EXN/M40-M20/R	171	EXN/M63-PG13/TC	173	EXN/PG16-PG13/R	173	EXN/PG36-PG29/R	173	EXN/PG9-050/TC	172
EXN/M40-M25/R	171	EXN/M63-PG16/TC	173	EXN/PG16-PG21/E	173	EXN/PG36-PG48/E	173	EXN/PG9-M16/TC	171
EXN/M40-M32/R	171	EXN/M63-PG21/TC	173	EXN/PG16-PG9/R	173	EXN/PG36-PG9/R	173	EXN/PG9-M20/TC	171
EXN/M40-M50/E	171	EXN/M63-PG29/TC	173	EXN/PG21/DSP	177	EXN/PG42/DSP	177	EXN02AMC3	165
EXN/M40-M63/E	171	EXN/M63-PG36/TC	173	EXN/PG21/HSP	177	EXN/PG42/HSP	177	EXN02MMC3	165
EXN/M40-PG11/TC	173	EXN/M63-PG42/TC	173	EXN/PG21/SP	175	EXN/PG42/SP	175	EXN03ALC3	165
EXN/M40-PG13/TC	173	EXN/M63-PG48/TC	173	EXN/PG21/TSP	175	EXN/PG42/TSP	175	EXN03AMC1	163
EXN/M40-PG16/TC	173	EXN/M63-PG9/TC	173	EXN/PG21-075/TC	172	EXN/PG42-050/TC	172	EXN03AMC2	167
EXN/M40-PG21/TC	173	EXN/M75-050/TC	172	EXN/PG21-100/TC	172	EXN/PG42-075/TC	172	EXN03AMC3	165
EXN/M40-PG29/TC	173	EXN/M75-075/TC	172	EXN/PG21-M16/TC	171	EXN/PG42-100/TC	172	EXN03ASC1	163
EXN/M40-PG36/TC	173	EXN/M75-100/TC	172	EXN/PG21-M20/TC	171	EXN/PG42-125/TC	172	EXN03MLC3	165
EXN/M40-PG9/TC	173	EXN/M75-125/TC	172	EXN/PG21-M25/TC	171	EXN/PG42-150/TC	172	EXN03MMC1	163
EXN/M50/C	178	EXN/M75-150/TC	172	EXN/PG21-M32/TC	171	EXN/PG42-200/TC	172	EXN03MMC2	167
EXN/M50/DSP	177	EXN/M75-200/TC	172	EXN/PG21-PG11/R	173	EXN/PG42-M16/TC	171	EXN03MMC3	165
EXN/M50/HSP	177	EXN/M75-M16/R	171	EXN/PG21-PG13/R	173	EXN/PG42-M20/TC	171	EXN03MSC1	163
EXN/M50/SP	175	EXN/M75-M20/R	171	EXN/PG21-PG16/R	173	EXN/PG42-M25/TC	171	EXN04ALC2	167
EXN/M50/TSP	175	EXN/M75-M25/R	171	EXN/PG21-PG29/E	173	EXN/PG42-M32/TC	171	EXN04ALC3	165
EXN/M50-050/TC	172	EXN/M75-M32/R	171	EXN/PG21-PG9/R	173	EXN/PG42-M40/TC	171	EXN04AMC1	163
EXN/M50-075/TC	172	EXN/M75-M40/R	171	EXN/PG29/DSP	177	EXN/PG42-M50/TC	171	EXN04AMC2	167
EXN/M50-100/TC	172	EXN/M75-M50/R	171	EXN/PG29/HSP	177	EXN/PG42-M63/TC	171	EXN04AMC3	165
EXN/M50-125/TC	172	EXN/M75-M63/R	171	EXN/PG29/SP	175	EXN/PG42-PG11/R	173	EXN04ASC1	163
EXN/M50-150/TC	172	EXN/M75-PG11/TC	173	EXN/PG29/TSP	175	EXN/PG42-PG13/R	173	EXN04ASC3	165
EXN/M50-200/TC	172	EXN/M75-PG13/TC	173	EXN/PG29-050/TC	172	EXN/PG42-PG16/R	173	EXN04MLC1	163
EXN/M50-M16/R	171	EXN/M75-PG16/TC	173	EXN/PG29-075/TC	172	EXN/PG42-PG21/R	173	EXN04MLC1	163
EXN/M50-M20/R	171	EXN/M75-PG21/TC	173	EXN/PG29-100/TC	172	EXN/PG42-PG29/R	173	EXN04MLC2	167
EXN/M50-M25/R	171	EXN/M75-PG29/TC	173	EXN/PG29-125/TC	172	EXN/PG42-PG36/R	173	EXN04MLC3	165
EXN/M50-M32/R	171	EXN/M75-PG36/TC	173	EXN/PG29-150/TC	172	EXN/PG42-PG48/E	173	EXN04MMC1	163

Part No.	Page	Part No.	Page	Part No.	Page	Part No.	Page	Part No.	Page
EXN04MMC2	167	EXN09ALC3	165	EXS/050-M16/TC	171	EXS/150-050/R	172	EXS/M20/C	178
EXN04MMC3	165	EXN09AMC1	163	EXS/050-M20/TC	171	EXS/150-075/R	172	EXS/M20/DSP	177
EXN04MSC1	163	EXN09AMC2	167	EXS/050-M25/TC	171	EXS/150-100/R	172	EXS/M20/HSP	177
EXN04MSC3	165	EXN09AMC3	165	EXS/050-PG11/TC	173	EXS/150-125/R	172	EXS/M20/SP	175
EXN05ALC2	167	EXN09ASC1	163	EXS/050-PG13/TC	173	EXS/150-200/E	172	EXS/M20/TSF	175
EXN05ALC3	165	EXN09MLC2	167	EXS/050-PG16/TC	173	EXS/150-M16/TC	171	EXS/M20-050/TC	172
EXN05AMC1	163	EXN09MLC3	165	EXS/050-PG9/TC	173	EXS/150-M20/TC	171	EXS/M20-075/TC	172
EXN05AMC2	167	EXN09MMC1	163	EXS/075/SP	175	EXS/150-M25/TC	171	EXS/M20-M16/R	171
EXN05AMC3	165	EXN09MMC2	167	EXS/075/TSP	175	EXS/150-M32/TC	171	EXS/M20-M25/E	171
EXN05ASC1	163	EXN09MMC3	165	EXS/075-050/R	172	EXS/150-M40/TC	171	EXS/M20-M32/E	171
EXN05ASC3	165	EXN09MSC1	163	EXS/075-100/E	172	EXS/150-M50/TC	171	EXS/M20-PG11/TC	173
EXN05MLC1	163	EXN10ALC2	167	EXS/075-M16/TC	171	EXS/150-M63/TC	171	EXS/M20-PG13/TC	173
EXN05MLC2	167	EXN10ALC3	165	EXS/075-M20/TC	171	EXS/150-PG11/TC	173	EXS/M20-PG16/TC	173
EXN05MLC3	165	EXN10AMC1	163	EXS/075-M25/TC	171	EXS/150-PG13/TC	173	EXS/M20-PG9/TC	173
EXN05MMC1	163	EXN10AMC2	167	EXS/075-M32/TC	171	EXS/150-PG16/TC	173	EXS/M25/C	178
EXN05MMC2	167	EXN10AMC3	165	EXS/075-PG11/TC	173	EXS/150-PG21/TC	173	EXS/M25/DSP	177
EXN05MMC3	165	EXN10ASC1	163	EXS/075-PG13/TC	173	EXS/150-PG29/TC	173	EXS/M25/HSP	177
EXN05MSC1	163	EXN10MLC2	167	EXS/075-PG16/TC	173	EXS/150-PG36/TC	173	EXS/M25/SP	175
EXN05MSC3	165	EXN10MMC1	163	EXS/075-PG21/TC	173	EXS/150-PG42/TC	173	EXS/M25/TSF	175
EXN06ALC2	167	EXN10MMC2	167	EXS/075-PG9/TC	173	EXS/150-PG9/TC	173	EXS/M25-050/TC	172
EXN06ALC3	165	EXN10MSC1	163	EXS/100/SP	175	EXS/200/SP	175	EXS/M25-075/TC	172
EXN06AMC1	163	EXN11ALC3	165	EXS/100/TSP	175	EXS/200/TSP	175	EXS/M25-100/TC	172
EXN06AMC2	167	EXN11AMC1	163	EXS/100-050/R	172	EXS/200-050/R	172	EXS/M25-M16/R	171
EXN06AMC3	165	EXN11ASC1	163	EXS/100-075/R	172	EXS/200-075/R	172	EXS/M25-M20/R	171
EXN06ASC1	163	EXN11MLC3	165	EXS/100-125/E	172	EXS/200-100/R	172	EXS/M25-M32/E	171
EXN06ASC3	165	EXN11MMC1	163	EXS/100-M16/TC	171	EXS/200-125/R	172	EXS/M25-M40/E	171
EXN06MLC2	167	EXN11MSC1	163	EXS/100-M20/TC	171	EXS/200-150/R	172	EXS/M25-PG11/TC	173
EXN06MLC3	165	EXN12ALC2	167	EXS/100-M25/TC	171	EXS/200-M16/TC	171	EXS/M25-PG13/TC	173
EXN06MMC1	163	EXN12AMC1	163	EXS/100-M32/TC	171	EXS/200-M20/TC	171	EXS/M25-PG16/TC	173
EXN06MMC2	167	EXN12AMC2	167	EXS/100-M40/TC	171	EXS/200-M25/TC	171	EXS/M25-PG21/TC	173
EXN06MMC3	165	EXN12MLC2	167	EXS/100-PG11/TC	173	EXS/200-M32/TC	171	EXS/M25-PG9/TC	173
EXN06MSC1	163	EXN12MMC1	163	EXS/100-PG13/TC	173	EXS/200-M40/TC	171	EXS/M32/C	178
EXN06MSC3	165	EXN12MMC2	167	EXS/100-PG16/TC	173	EXS/200-M50/TC	171	EXS/M32/DSP	177
EXN07ALC2	167	EXN13AMC2	167	EXS/100-PG21/TC	173	EXS/200-M63/TC	171	EXS/M32/HSP	177
EXN07AM3	165	EXN13MMC2	167	EXS/100-PG29/TC	173	EXS/200-PG11/TC	173	EXS/M32/SP	175
EXN07AMC1	163	EXN14AMC1	163	EXS/100-PG9/TC	173	EXS/200-PG13/TC	173	EXS/M32/TSF	175
EXN07AMC2	167	EXN14AMC2	167	EXS/125/SP	175	EXS/200-PG16/TC	173	EXS/M32-050/TC	172
EXN07ASC1	163	EXN14MMC1	163	EXS/125/TSP	175	EXS/200-PG21/TC	173	EXS/M32-075/TC	172
EXN07MLC2	167	EXN14MMC2	167	EXS/125-050/R	172	EXS/200-PG29/TC	173	EXS/M32-100/TC	172
EXN07MMC3	165	EXPQA0303	141	EXS/125-075/R	172	EXS/200-PG36/TC	173	EXS/M32-125/TC	172
EXN07MMC1	163	EXPQA0404	141	EXS/125-100/R	172	EXS/200-PG42/TC	173	EXS/M32-M16/R	171
EXN07MMC2	167	EXPQA0505	141	EXS/125-150/E	172	EXS/200-PG48/TC	173	EXS/M32-M20/R	171
EXN07MSC1	163	EXPQA0606	141	EXS/125-M16/TC	171	EXS/200-PG9/TC	173	EXS/M32-M25/R	171
EXN08ALC2	167	EXPQA0707	141	EXS/125-M20/TC	171	EXS/250-M50/TC	171	EXS/M32-M40/E	171
EXN08ALC3	165	EXPQA0808	141	EXS/125-M25/TC	171	EXS/300-M50/TC	171	EXS/M32-M50/E	171
EXN08AMC1	163	EXPQM0303	141	EXS/125-M32/TC	171	EXS/M16/C	178	EXS/M32-PG11/TC	173
EXN08AMC2	167	EXPQM0404	141	EXS/125-M40/TC	171	EXS/M16/DSP	177	EXS/M32-PG13/TC	173
EXN08AMC3	165	EXPQM0505	141	EXS/125-M50/TC	171	EXS/M16/HSP	177	EXS/M32-PG16/TC	173
EXN08ASC1	163	EXPQM0606	141	EXS/125-PG11/TC	173	EXS/M16/SP	175	EXS/M32-PG21/TC	173
EXN08MLC2	167	EXPQM0707	141	EXS/125-PG13/TC	173	EXS/M16/TSF	175	EXS/M32-PG29/TC	173
EXN08MLC3	165	EXPQM0808	141	EXS/125-PG16/TC	173	EXS/M16-038/TC	172	EXS/M32-PG9/TC	173
EXN08MMC1	163	EXS/038/SP	175	EXS/125-PG21/TC	173	EXS/M16-050/TC	172	EXS/M40/C	178
EXN08MMC2	167	EXS/038/TSP	175	EXS/125-PG29/TC	173	EXS/M16-M20/E	171	EXS/M40/DSP	177
EXN08MMC3	165	EXS/038-M16/TC	171	EXS/125-PG36/TC	173	EXS/M16-M25/E	171	EXS/M40/HSP	177
EXN08MSC1	163	EXS/050/SP	175	EXS/125-PG9/TC	173	EXS/M16-M32/E	171	EXS/M40/SP	175
EXN09ALC2	167	EXS/050/TSP	175	EXS/150/SP	175	EXS/M16-PG11/TC	173	EXS/M40/TSF	175
		EXS/050-075/E	172	EXS/150/TSP	175	EXS/M16-PG13/TC	173	EXS/M40-050/TC	172
						EXS/M16-PG9/TC	173		

Index

Part No.	Page	Part No.	Page	Part No.	Page	Part No.	Page	Part No.	Page
EXS/M40-075/TC	172	EXS/M63-M32/R	171	EXS/PG16-075/TC	172	EXS/PG36-M50/TC	171	EXS/PG48-PG9/R	173
EXS/M40-100/TC	172	EXS/M63-M40/R	171	EXS/PG16-M16/TC	171	EXS/PG36-PG11/R	173	EXS/PG9/DSP	177
EXS/M40-125/TC	172	EXS/M63-M50/R	171	EXS/PG16-M20/TC	171	EXS/PG36-PG13/R	173	EXS/PG9/HSP	177
EXS/M40-150/TC	172	EXS/M63-M75/E	171	EXS/PG16-M25/TC	171	EXS/PG36-PG16/R	173	EXS/PG9/SP	175
EXS/M40-M16/R	171	EXS/M63-PG11/TC	173	EXS/PG16-PG11/R	173	EXS/PG36-PG21/R	173	EXS/PG9/TSP	175
EXS/M40-M20/R	171	EXS/M63-PG13/TC	173	EXS/PG16-PG13/R	173	EXS/PG36-PG29/R	173	EXS/PG9-050/TC	172
EXS/M40-M25/R	171	EXS/M63-PG16/TC	173	EXS/PG16-PG21/E	173	EXS/PG36-PG48/E	173	EXS/PG9-M16/TC	171
EXS/M40-M32/R	171	EXS/M63-PG21/TC	173	EXS/PG16-PG9/R	173	EXS/PG36-PG9/R	173	EXS/PG9-M20/TC	171
EXS/M40-M50/E	171	EXS/M63-PG29/TC	173	EXS/PG21/DSP	177	EXS/PG42/DSP	177	EXS02AMC3	165
EXS/M40-M63/E	171	EXS/M63-PG36/TC	173	EXS/PG21/HSP	177	EXS/PG42/HSP	177	EXS02MMC3	165
EXS/M40-PG11/TC	173	EXS/M63-PG42/TC	173	EXS/PG21/SP	175	EXS/PG42/SP	175	EXS03ALC3	165
EXS/M40-PG13/TC	173	EXS/M63-PG48/TC	173	EXS/PG21/TSP	175	EXS/PG42/TSP	175	EXS04AMC1	163
EXS/M40-PG16/TC	173	EXS/M63-PG9/TC	173	EXS/PG21-075/TC	172	EXS/PG42-050/TC	172	EXS03AMC2	167
EXS/M40-PG21/TC	173	EXS/M75-050/TC	172	EXS/PG21-100/TC	172	EXS/PG42-075/TC	172	EXS03AMC3	165
EXS/M40-PG29/TC	173	EXS/M75-075/TC	172	EXS/PG21-M16/TC	171	EXS/PG42-100/TC	172	EXS03ASC1	163
EXS/M40-PG36/TC	173	EXS/M75-100/TC	172	EXS/PG21-M20/TC	171	EXS/PG42-125/TC	172	EXS03MLC3	165
EXS/M40-PG9/TC	173	EXS/M75-125/TC	172	EXS/PG21-M25/TC	171	EXS/PG42-150/TC	172	EXS03MMC1	163
EXS/M50/C	178	EXS/M75-150/TC	172	EXS/PG21-M32/TC	171	EXS/PG42-200/TC	172	EXS03MMC2	167
EXS/M50/DSP	177	EXS/M75-200/TC	172	EXS/PG21-PG11/R	173	EXS/PG42-M16/TC	171	EXS03MMC3	165
EXS/M50/HSP	177	EXS/M75-M16/R	171	EXS/PG21-PG13/R	173	EXS/PG42-M20/TC	171	EXS03MSC1	163
EXS/M50/SP	175	EXS/M75-M20/R	171	EXS/PG21-PG16/R	173	EXS/PG42-M25/TC	171	EXS04ALC2	167
EXS/M50/TSP	175	EXS/M75-M25/R	171	EXS/PG21-PG29/E	173	EXS/PG42-M32/TC	171	EXS04ALC3	165
EXS/M50-050/TC	172	EXS/M75-M32/R	171	EXS/PG21-PG9/R	173	EXS/PG42-M40/TC	171	EXS04AMC1	163
EXS/M50-075/TC	172	EXS/M75-M40/R	171	EXS/PG29/DSP	177	EXS/PG42-M50/TC	171	EXS04AMC2	167
EXS/M50-100/TC	172	EXS/M75-M50/R	171	EXS/PG29/HSP	177	EXS/PG42-M63/TC	171	EXS04AMC3	165
EXS/M50-125/TC	172	EXS/M75-M63/R	171	EXS/PG29/SP	175	EXS/PG42-PG11/R	173	EXS04ASC1	163
EXS/M50-150/TC	172	EXS/M75-PG11/TC	173	EXS/PG29/TSP	175	EXS/PG42-PG13/R	173	EXS04ASC3	165
EXS/M50-200/TC	172	EXS/M75-PG13/TC	173	EXS/PG29-050/TC	172	EXS/PG42-PG16/R	173	EXS04MLC1	163
EXS/M50-M16/R	171	EXS/M75-PG16/TC	173	EXS/PG29-075/TC	172	EXS/PG42-PG21/R	173	EXS04MLC1	163
EXS/M50-M20/R	171	EXS/M75-PG21/TC	173	EXS/PG29-100/TC	172	EXS/PG42-PG29/R	173	EXS04MLC2	167
EXS/M50-M25/R	171	EXS/M75-PG29/TC	173	EXS/PG29-125/TC	172	EXS/PG42-PG36/R	173	EXS04MLC3	165
EXS/M50-M32/R	171	EXS/M75-PG36/TC	173	EXS/PG29-150/TC	172	EXS/PG42-PG48/E	173	EXS04MMC1	163
EXS/M50-M40/R	171	EXS/M75-PG42/TC	173	EXS/PG29-M16/TC	171	EXS/PG42-PG9/R	173	EXS04MMC2	167
EXS/M50-M63/E	171	EXS/M75-PG48/TC	173	EXS/PG29-M20/TC	171	EXS/PG48/DSP	177	EXS04MMC3	165
EXS/M50-M75/E	171	EXS/M75-PG9/TC	173	EXS/PG29-M25/TC	171	EXS/PG48/HSP	177	EXS04MSC1	163
EXS/M50-PG11/TC	173	EXS/PG11/DSP	177	EXS/PG29-M32/TC	171	EXS/PG48/SP	175	EXS04MSC3	165
EXS/M50-PG13/TC	173	EXS/PG11/HSP	177	EXS/PG29-M40/TC	171	EXS/PG48/TSP	175	EXS05ALC2	167
EXS/M50-PG16/TC	173	EXS/PG11/SP	175	EXS/PG29-PG11/R	173	EXS/PG48-050/TC	172	EXS05ALC3	165
EXS/M50-PG21/TC	173	EXS/PG11/TSP	175	EXS/PG29-PG13/R	173	EXS/PG48-075/TC	172	EXS05AMC1	163
EXS/M50-PG29/TC	173	EXS/PG11-050/TC	172	EXS/PG29-PG16/R	173	EXS/PG48-100/TC	172	EXS05AMC2	167
EXS/M50-PG36/TC	173	EXS/PG11-M16/TC	171	EXS/PG29-PG21/R	173	EXS/PG48-125/TC	172	EXS05AMC3	165
EXS/M50-PG42/TC	173	EXS/PG11-M20/TC	171	EXS/PG29-PG36/E	173	EXS/PG48-150/TC	172	EXS05ASC1	163
EXS/M50-PG9/TC	173	EXS/PG11-PG9/R	173	EXS/PG29-PG9/R	173	EXS/PG48-200/TC	172	EXS05ASC3	165
EXS/M63/C	178	EXS/PG13/DSP	177	EXS/PG36/DSP	177	EXS/PG48-M16/TC	171	EXS05MLC1	163
EXS/M63/DSP	177	EXS/PG13/HSP	177	EXS/PG36/HSP	177	EXS/PG48-M20/TC	171	EXS05MLC1	163
EXS/M63/HSP	177	EXS/PG13/SP	175	EXS/PG36/SP	175	EXS/PG48-M25/TC	171	EXS05MLC2	167
EXS/M63/SP	175	EXS/PG13/TSP	175	EXS/PG36/TSP	175	EXS/PG48-M32/TC	171	EXS05MLC3	165
EXS/M63/TSP	175	EXS/PG13-050/TC	172	EXS/PG36-050/TC	172	EXS/PG48-M40/TC	171	EXS05MMC1	163
EXS/M63-050/TC	172	EXS/PG13-M16/TC	171	EXS/PG36-075/TC	172	EXS/PG48-M50/TC	171	EXS05MMC2	167
EXS/M63-075/TC	172	EXS/PG13-M20/TC	171	EXS/PG36-100/TC	172	EXS/PG48-M63/TC	171	EXS05MMC3	165
EXS/M63-100/TC	172	EXS/PG13-PG11/R	173	EXS/PG36-125/TC	172	EXS/PG48-PG11/R	173	EXS05MSC1	163
EXS/M63-125/TC	172	EXS/PG13-PG9/R	173	EXS/PG36-150/TC	172	EXS/PG48-PG13/R	173	EXS05MSC3	165
EXS/M63-150/TC	172	EXS/PG16/DSP	177	EXS/PG36-M16/TC	171	EXS/PG48-PG16/R	173	EXS06ALC2	167
EXS/M63-200/TC	172	EXS/PG16/HSP	177	EXS/PG36-M20/TC	171	EXS/PG48-PG21/R	173	EXS06ALC3	165
EXS/M63-M16/R	171	EXS/PG16/SP	175	EXS/PG36-M25/TC	171	EXS/PG48-PG29/R	173	EXS06AMC1	163
EXS/M63-M20/R	171	EXS/PG16/TSP	175	EXS/PG36-M32/TC	171	EXS/PG48-PG36/R	173	EXS06AMC2	167
EXS/M63-M25/R	171	EXS/PG16-050/TC	172	EXS/PG36-M40/TC	171	EXS/PG48-PG42/R	173	EXS06AMC3	165

Part No.	Page	Part No.	Page	Part No.	Page	Part No.	Page	Part No.	Page
EXS06ASC1	163	EXS11MMC1	163	EXSH0920	151	FF012	95	HAA0606G1	153
EXS06ASC3	165	EXS11MSC1	163	EXSHC0310	151	FF013	95	HAA0606U	156
EXS06MLC2	167	EXS12ALC2	167	EXSHC0310	151	FF015C	95	HAA0606U/SW	157
EXS06MLC3	165	EXS12AMC1	163	EXSHC0330	151	FF019C	95	HAA0707	159
EXS06MMC1	163	EXS12AMC2	167	EXSHC0330	151	FF023D	95	HAA0707E	154
EXS06MMC2	167	EXS12MLC2	167	EXSHC0410	151	FF024D	95	HAA0707G1	153
EXS06MMC3	165	EXS12MMC1	163	EXSHC0410	151	FF026	95	HAA0707U	156
EXS06MSC1	163	EXS12MMC2	167	EXSHC0430	151	FF220-0G000	71	HAA0707U/SW	157
EXS06MSC3	165	EXS13AMC2	167	EXSHC0430	151	FF220EM-0G000	85	HAA0808	159
EXS07ALC2	167	EXS13MMC2	167	EXSHC0510	151	FF236-0G000	71	HAA0808E	154
EXS07AM3	165	EXS14AMC1	163	EXSHC0510	151	FF240-0G000	71	HAA0808G1	153
EXS07AMC1	163	EXS14AMC2	167	EXSHC0530	151	FF240EM-0G000	85	HAA0808U	156
EXS07AMC2	167	EXS14MMC1	163	EXSHC0530	151	FF255-0G000	71	HAA0808U/SW	157
EXS07ASC1	163	EXS14MMC2	167	EXSHC0610	151	FF265-0G000	71	HAA0909	159
EXS07MLC2	167	EXSB0310	150	EXSHC0610	151	FL30P-00000	81	HAA0909E	154
EXS07MM3	165	EXSB0330	150	EXSHC0620	151	FL30P-0C000	81	HAA0909G1	153
EXS07MMC1	163	EXSB0410	150	EXSHC0630	151	FL30P-0D000	81	HAA0909U	156
EXS07MMC2	167	EXSB0430	150	EXSHC0710	151	FL30P-0E000	81	HAA0909U/SW	157
EXS07MSC1	163	EXSB0510	150	EXSHC0710	151	FL30P-0F000	81	HAAM0304	159
EXS08ALC2	167	EXSB0530	150	EXSHC0720	151	FR120-0G000	71	HAAM0304E	154
EXS08ALC3	165	EXSB0610	150	EXSHC0810	151	FR120EM-0G000	85	HAAM0304G1	153
EXS08AMC1	163	EXSB0620	150	EXSHC0810	151	FR136-0G000	71	HAAM0304U	156
EXS08AMC2	167	EXSB0630	150	EXSHC0820	151	FR140-0G000	71	HAAM0304U/SW	157
EXS08AMC3	165	EXSB0710	150	EXSHC0910	151	FR140EM-0G000	85	HAAM0404	159
EXS08ASC1	163	EXSB0720	150	EXSHC0910	151	FR155-0G000	71	HAAM0404E	154
EXS08MLC2	167	EXSB0730	150	EXSHC0920	151	FR165-0G000	71	HAAM0404G1	153
EXS08MLC3	165	EXSB0810	150	EXSLH0310	151	GUB01CS	129	HAAM0404U	156
EXS08MMC1	163	EXSB0820	150	EXSLH0330	151	GUB02DS	129	HAAM0404U/SW	157
EXS08MMC2	167	EXSB0910	150	EXSLH0410	151	GUB03ES	129	HAAM0505	159
EXS08MMC3	165	EXSB0920	150	EXSLH0430	151	GUB04FF	129	HAAM0505E	154
EXS08MSC1	163	EXSBBT0310	150	EXSLH0510	151	GUB0AS	129	HAAM0505G1	153
EXS09ALC2	167	EXSBBT0330	150	EXSLH0530	151	GUB0BS	129	HAAM0505U	156
EXS09ALC3	165	EXSBBT0410	150	EXSLH0610	151	GUV26-00000	121	HAAM0505U/SW	157
EXS09AMC1	163	EXSBBT0430	150	EXSLH0620	151	GUV36-00000	121	HAAM0606	159
EXS09AMC2	167	EXSBBT0510	150	EXSLH0710	151	GUVL26-00000	121	HAAM0606E	154
EXS09AMC3	165	EXSBBT0530	150	EXSLH0720	151	GUVL36-00000	121	HAAM0606G1	153
EXS09ASC1	163	EXSBBT0610	150	EXSLH0810	151	GUVT26-00000	121	HAAM0606U	156
EXS09MLC2	167	EXSBBT0620	150	EXSLH0820	151	GUVT36-00000	121	HAAM0606U/SW	157
EXS09MLC3	165	EXSBBT0710	150	EXSLH0910	151	GUVX26-00000	121	HAAM0707	159
EXS09MMC1	163	EXSBBT0720	150	EXSLH0920	151	GUVX36-00000	121	HAAM0707E	154
EXS09MMC2	167	EXSBBT0810	150	EXST0310	150	HAA0304	159	HAAM0707G1	153
EXS09MMC3	165	EXSBBT0820	150	EXST0330	150	HAA0304E	154	HAAM0707U	156
EXS09MSC1	163	EXSBBT0910	150	EXST0410	150	HAA0304G1	153	HAAM0707U/SW	157
EXS10ALC2	167	EXSBBT0920	150	EXST0430	150	HAA0304U	156	HAAM0808	159
EXS10AMC1	163	EXSH0310	151	EXST0510	150	HAA0304U/SW	157	HAAM0808E	154
EXS10AMC2	167	EXSH0330	151	EXST0530	150	HAA0404	159	HAAM0808G1	153
EXS10AMC3	165	EXSH0410	151	EXST0610	150	HAA0404E	154	HAAM0808U	156
EXS10ASC1	163	EXSH0430	151	EXST0620	150	HAA0404G1	153	HAAM0808U/SW	157
EXS10MLC2	167	EXSH0510	151	EXST0710	150	HAA0404U	156	HAAM0909	159
EXS10MMC1	163	EXSH0530	151	EXST0720	150	HAA0404U/SW	157	HAAM0909E	154
EXS10MMC2	167	EXSH0610	151	EXST0810	150	HAA0505	159	HAAM0909G1	153
EXS10MMC3	165	EXSH0620	151	EXST0820	150	HAA0505E	154	HAAM0909U	156
EXS10MSC1	163	EXSH0710	151	EXST0910	150	HAA0505G1	153	HAAM0909U/SW	157
EXS11ALC3	165	EXSH0720	151	EXST0920	150	HAA0505U	156	HAAS0304G1	153
EXS11AMC1	163	EXSH0810	151	FB30-00000	81	HAA0505U/SW	157	HAAS0304U	156
EXS11ASC1	163	EXSH0820	151	FB70-00000	81	HAA0606	159	HAAS0404	159
EXS11MLC3	165	EXSH0910	151	FF005C	95	HAA0606E	154	HAAS0404G1	153

Index

Part No.	Page	Part No.	Page	Part No.	Page	Part No.	Page	Part No.	Page
HAAS0404U	156	HAMM0404E	154	L021	95	NENZ-M120S/P	143	S00770W	97
HAAS0505	159	HAMM0404G1	153	L022110VAC	95	NENZ-M160S/P	143	SF150G-00000	75
HAAS0505G1	153	HAMM0404U	156	L022110VCC	95	NENZ-M202S/P	143	SF150P-00000	75
HAAS0505U	156	HAMM0404U/SW	157	L022220VAC	95	NENZ-M207S/P	143	SF250G-00000	75
HAAS0606	159	HAMM0505	159	L02224VCC	95	NENZ-M257S/P	143	SF250P-00000	75
HAAS0606G1	153	HAMM0505E	154	L02248VCC	95	NENZ-M323S/P	143	SF400G-00000	75
HAAS0606U	156	HAMM0505G1	153	M005	93	NENZ-M409S/P	143	SF400P-00000	75
HAAS0707	159	HAMM0505U	156	MXWH04	178	NENZ-M506S/P	143	SF70G-00000	75
HAAS0707G1	153	HAMM0505U/SW	157	MXWH05	178	NENZ-M508S/P	143	SF70P-00000	75
HAAS0707U	156	HAMM0606	159	MXWH06	178	NENZ-M638S/P	143	SRC215	123
HAAS0808	159	HAMM0606E	154	MXWH07	178	NEWV-M120-10*	144	SRC215V	123
HAAS0808G1	153	HAMM0606G1	153	MXWH08	178	NEWV-M160-10*	144	SRC330	123
HAAS0808U	156	HAMM0606U	156	NEAV-M120-10	144	NEWV-M162-10*	144	SRC340	123
HAAS0909	159	HAMM0606U/SW	157	NEAV-M162-10	144	NEWV-M202-10*	144	SRC415	123
HAAS0909G1	153	HAMM0707	159	NEAV-M207-10	144	P001	93	TL18W	96
HAAS0909U	156	HAMM0707E	154	NEAV-M253-11	144	P002	93	TL36W	96
HAM0304	159	HAMM0707G1	153	NEAV-M257-11	144	P004	93	TL58W	96
HAM0304E	154	HAMM0707U	156	NEAV-M323-13	144	P006	93	TL8W	96
HAM0304G1	153	HAMM0707U/SW	157	NEAV-M329-13	144	P006150SHP	97	V001	91
HAM0304U	156	HAMM0808	159	NEAV-M406-13	144	P006250IM	97	V004	91
HAM0304U/SW	157	HAMM0808E	154	NEAV-M409-13	144	P006250SHP	97	V005S	91
HAM0404	159	HAMM0808G1	153	NEAV-M506-14	144	P006400IM	97	V007N	91
HAM0404E	154	HAMM0808U	156	NEAV-M508-14	144	P006400SHP	97	V008	91
HAM0404G1	153	HAMM0808U/SW	157	NEAV-M638-14	144	P007	93	V008N	91
HAM0404U	156	HAMM0909	159	NEBV-M207-10	144	P008	93	V011	91
HAM0404U/SW	157	HAMM0909E	154	NEBV-M253-11	144	P009	93	V014	90
HAM0505	159	HAMM0909G1	153	NEBV-M257-11	144	P010	93	V015	90
HAM0505E	154	HAMM0909U	156	NEBV-M323-13	144	P012	93	V016	90
HAM0505G1	153	HAMM0909U/SW	157	NEBV-M329-13	144	P017FC	93	V018	90
HAM0505U	156	HAMS0304G1	153	NEBV-M406-13	144	PB01	132	V021	90
HAM0505U/SW	157	HAMS0304U	157	NEBV-M409-13	144	PL11W	96	V023	90
HAM0606	159	HAMS0404	159	NEBV-M506-14	144	PL18W	96	V024	90
HAM0606E	154	HAMS0404G1	153	NEBV-M508-14	144	PL36W	96	VAB10	132
HAM0606G1	153	HAMS0404U	157	NEBV-M638-14	144	PL55W	96	VAC10	132
HAM0606U	156	HAMS0505	159	NEIR-M120	146	PL7W	96	VAJ10	132
HAM0606U/SW	157	HAMS0505G1	153	NEIR-M160	146	PL9W	96	VAR10	132
HAM0707	159	HAMS0505U	157	NEIR-M162	146	PR01	132	VAV10	132
HAM0707E	154	HAMS0606	159	NEIR-M207	146	PR02	132	WHAM04	178
HAM0707G1	153	HAMS0606G1	153	NEIR-M253	146	PR03	132	WHAM05	178
HAM0707U	156	HAMS0606U	157	NEIR-M329	146	PR04	132	WHAM06	178
HAM0707U/SW	157	HAMS0707	159	NEIR-M406	146	PR05	132	WHAM07	178
HAM0808	159	HAMS0707G1	153	NEIR-M508	146	PR06	132	WHAM08	178
HAM0808E	154	HAMS0707U	157	NEIR-M638	146	PR07	132	WHAM09	178
HAM0808G1	153	HAMS0808	159	NENV-M120-10	143	PR07V	132	WHMB03	178
HAM0808U	156	HAMS0808G1	153	NENV-M160-10	143	PRC10	132	WHMB04	178
HAM0808U/SW	157	HAMS0808U	157	NENV-M162-10	143	PRC20	132	WHMB05	178
HAM0909	159	HAMS0909	159	NENV-M202-10	143	PRC30	132	WHMB06	178
HAM0909E	154	HAMS0909G1	153	NENV-M207-10	143	PRC40	132	WHMB07	178
HAM0909G1	153	HAMS0909U	157	NENV-M253-11	143	PRC50	132	WHMB08	178
HAM0909U	156	HEAK-M32/25-13	147	NENV-M257-11	143	PRC60	132	WHMM03	178
HAM0909U/SW	157	HEAK-M40/32-13	147	NENV-M323-13	143	PRC70	132	WHMM04	178
HAMM0304	159	HEAK-M50/40-14	147	NENV-M329-13	143	QF250G-00000	75	WHMM05	178
HAMM0304E	154	HEAK-M63/63-14	147	NENV-M406-13	143	QF250P-00000	75	WHMM06	178
HAMM0304G1	153	HF55P-00000	83	NENV-M409-13	143	QF400G-00000	75	WHMM07	178
HAMM0304U	156	HF70P-00000	83	NENV-M506-14	143	QF400P-00000	75	WHMM08	178
HAMM0304U/SW	157	L00	95	NENV-M508-14	143	REA20	132	WHMM09	178
HAMM0404	159	L013	95	NENV-M638-114	143	S00755W	97	XB100-10BV	105

Part No.	Page	Part No.	Page	Part No.	Page	Part No.	Page	Part No.	Page
XB100-6BR	105	XBL23A	111	XEP220-0G000	35	XFL330-0D000	39	XPLFL236	161
XB100-6BV	105	XBL25	109	XEP220V-0G000	35	XFL330-0E000	39	XPLFL318	161
XB100A-10BV	105	XBL26-25R	107	XEP30011-0G000	35	XFL330-0F000	39	XQF250G-00000	37
XB100A-6BR	105	XBL26A	111	XEP30011V-0G000	35	XFP120-0G000	31	XQF250P-00000	37
XB100A-6BV	105	XBL28-25BR	107	XEP30028-0G000	35	XFP120EM-0G000	53	XQF400G-00000	37
XB10A-SI	107	XBL35	109	XEP30028V-0G000	35	XFP120V EM-0G000	53	XQF400P-00000	37
XB10-SI	107	XBL38A	111	XEP3008-0G000	35	XFP120V-0G000	31	XSF150G-00000	37
XB215A	115	XBL38AMP	111	XEP3008V-0G000	35	XFP136-0G000	31	XSF150P-00000	37
XB215VA	115	XBL40	109	XEP3009-0G000	35	XFP136V-0G000	31	XSF250G-00000	37
XB21A	115	XBL41A	111	XEP3009V-0G000	35	XFP140-0G000	31	XSF250P-00000	37
XB21FA	115	XBL43A	111	XESX0250	139	XFP140EM-0G000	53	XSF400G-00000	37
XB21VA	115	XBL45	109	XESX0350	139	XFP140V EM-0G000	53	XSF400P-00000	37
XB22A	115	XBL55	109	XESX0450	139	XFP140V-0G000	31	XSF70G-00000	37
XB22AMP	115	XBL65	109	XESX0550	139	XFP155-0G000	31	XSF70P-00000	37
XB23A	115	XBL75	109	XESX0650	139	XFP155V-0G000	31	Z001	91
XB26A	115	XDF140-00000	41	XESX0750	139	XFP165-0G000	31	Z007	91
XB300	113	XDF140-0D000	41	XESX0850	139	XFP165V-0G000	31		
XB38A	115	XDF165-00000	41	XESX-10BY.50	139	XFP220-0G000	31		
XB38AMP	115	XDF165-0D000	41	XESX-12BY.50	139	XFP220EM-0G000	53		
XB400	113	XEF110G-00000	37	XESX-17BY.50	139	XFP220V EM-0G000	53		
XB41A	115	XEF110P-00000	37	XESX-23BY.50	139	XFP220V-0G000	31		
XB43A	115	XEF140G-00000	37	XESX-29BY.50	139	XFP236-0G000	31		
XB510	113	XEF140P-00000	37	XESX-36BY.30	139	XFP236V-0G000	31		
XB520	113	XEL120-0G000	33	XESX-48BY.30	139	XFP240-0G000	31		
XB570	113	XEL120V-0G000	33	XFB230-00000	39	XFP240EM-0G000	53		
XB700	113	XEL220-0G000	33	XFB270-00000	39	XFP240V EM-0G000	53		
XB710	113	XEL220V-0G000	33	XFB30-00000	39	XFP240V-0G000	31		
XB750	113	XEL3001-00000	55	XFB330-00000	39	XFP255-0G000	31		
XB950	113	XEL30011-0G000	33	XFB370-00000	39	XFP255V-0G000	31		
XB960	113	XEL30011V-0G000	33	XFB70-00000	39	XFP265-0G000	31		
XBAMP	115	XEL3001V-00000	55	XFF012	95	XFP265V-0G000	31		
XBI100	117	XEL3002-00000	55	XFF220-0G000	29	XFR120-0G000	29		
XBI150	117	XEL30028-0G000	33	XFF220EM-0G000	51	XFR120EM-0G000	51		
XBI200	117	XEL30028V-0G000	33	XFF220V-0G000	29	XFR120V-0G000	29		
XBI215A	119	XEL3002V-00000	55	XFF220VEM-0G000	51	XFR120VEM-0G000	51		
XBI21A	119	XEL3008-0G000	33	XFF236-0G000	29	XFR136-0G000	29		
XBI21FA	119	XEL3008V-0G000	33	XFF236V-0G000	29	XFR136V-0G000	29		
XBI21VA	119	XEL3009-0G000	33	XFF240-0G000	29	XFR140-0G000	29		
XBI22A	119	XEL3009V-0G000	33	XFF240EM-0G000	51	XFR140EM-0G000	51		
XBI23A	119	XEL300A-00000	55	XFF240V-0G000	29	XFR140V-0G000	29		
XBI26A	119	XEL300AI-00000	55	XFF240VEM-0G000	51	XFR140VEM-0G000	51		
XBI300	117	XEL300AK-00000	55	XFF255-0G000	29	XFR155-0G000	29		
XBI38A	119	XEL300SI-00000	55	XFF255V-0G000	29	XFR155V-0G000	29		
XBI400	117	XEL300VA-00000	55	XFF265-0G000	29	XFR165-0G000	29		
XBI41A	119	XEL300VAI-00000	55	XFF265V-0G000	29	XFR165V-0G000	29		
XBI43A	119	XEL300VAK-00000	55	XFL230-00000	39	XMC36	123		
XBI500	117	XEL300VSI-00000	55	XFL230-0C000	39	XPLFL110	161		
XBI600	117	XEL80A-00000	55	XFL230-0D000	39	XPLFL112	161		
XBL15	109	XEL80AI-00000	55	XFL230-0E000	39	XPLFL115	161		
XBL20	109	XEL80AK-00000	55	XFL230-0F000	39	XPLFL118	161		
XBL215A	111	XEL80SI-0J000	55	XFL30P-00000	39	XPLFL124	161		
XBL215VA	111	XEL80VA-0J000	55	XFL30P-0C000	39	XPLFL16	161		
XBL21A	111	XEL80VAI-00000	55	XFL30P-0D000	39	XPLFL18	161		
XBL21FA	111	XEL80VAK-00000	55	XFL30P-0E000	39	XPLFL212	161		
XBL21VA	111	XEL80VSI-0J000	55	XFL30P-0F000	39	XPLFL215	161		
XBL22A	111	XEP120-0G000	35	XFL330-00000	39	XPLFL218	161		
XBL22AMP	111	XEP120V-0G000	35	XFL330-0C000	39	XPLFL224	161		



Thomas & Betts Worldwide Industrial Capabilities

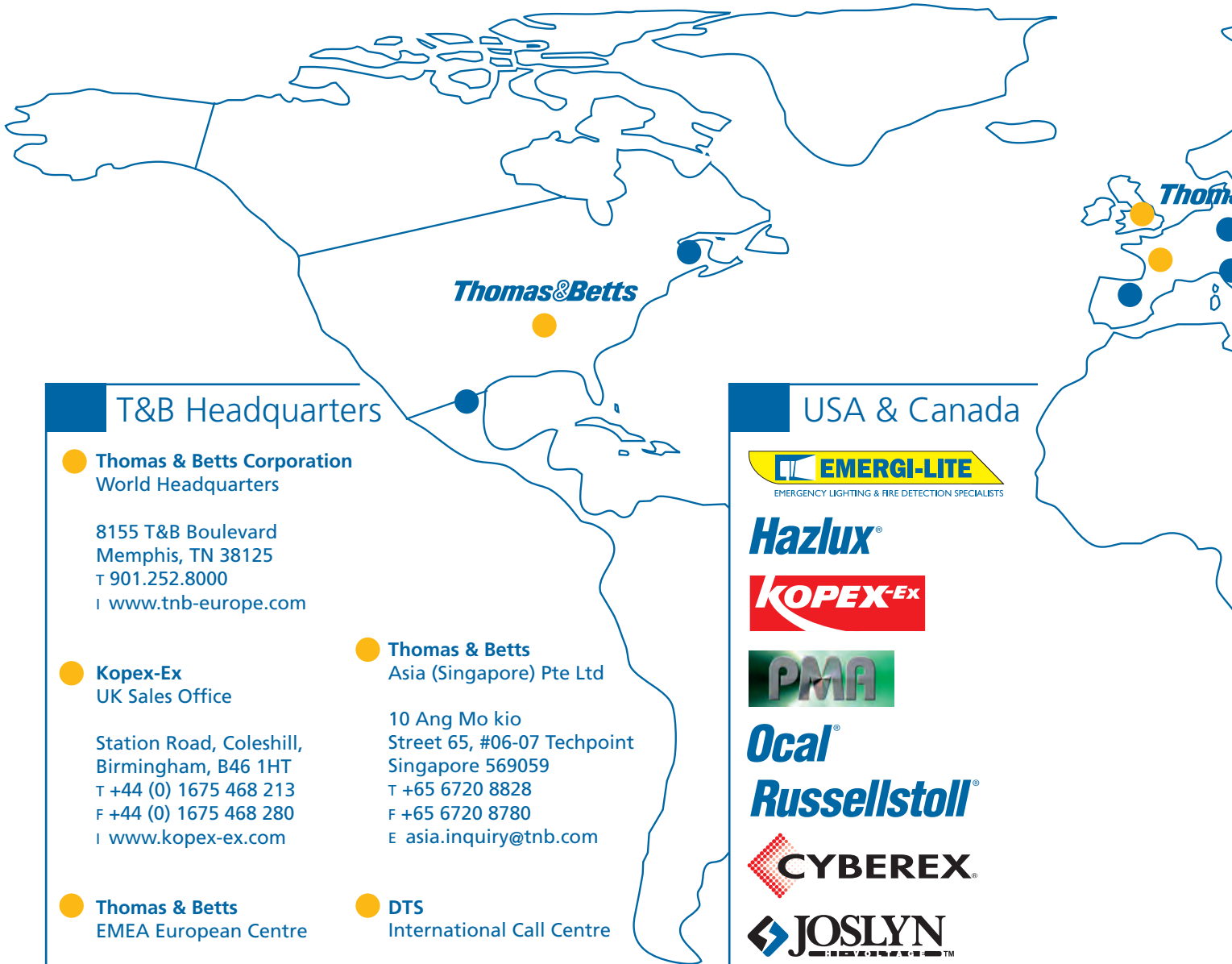

T&B Headquarters

- **Thomas & Betts Corporation**
World Headquarters

8155 T&B Boulevard
Memphis, TN 38125
T 901.252.8000
I www.tnb-europe.com

- **Kopex-Ex**
UK Sales Office

Station Road, Coleshill,
Birmingham, B46 1HT
T +44 (0) 1675 468 213
F +44 (0) 1675 468 280
I www.kopex-ex.com

- **Thomas & Betts**
EMEA European Centre

200 Chaussee de Waterloo
B-1640 Rhode-St-Genese
Belgium
T +32 (0) 2 359 82 00
F +44 (0) 2 359 82 01
E europe_inquiry@tnb.com

- **Thomas & Betts**
Asia (Singapore) Pte Ltd

10 Ang Mo kio
Street 65, #06-07 Techpoint
Singapore 569059
T +65 6720 8828
F +65 6720 8780
E asia.inquiry@tnb.com

- **DTS**
International Call Centre

Z.I. Parc d'Activités de la Gare
19 à 21 avenue Henri Beaudalet
B.P. 27 - 77831 Ozoir Cedex
France
T +33 (0) 1 64 40 27 26
F +33 (0) 1 64 40 20 11
E exportsales@dtsselec.fr
I www.tnb-hazardous.com

USA & Canada



Hazlux®



Ocal®

Russellstoll®



HOMAC

Blackburn®

Kindorf®

T&B® Cable Tray

Color-Keyed®

Thomas & Betts - Industrial Capabilities

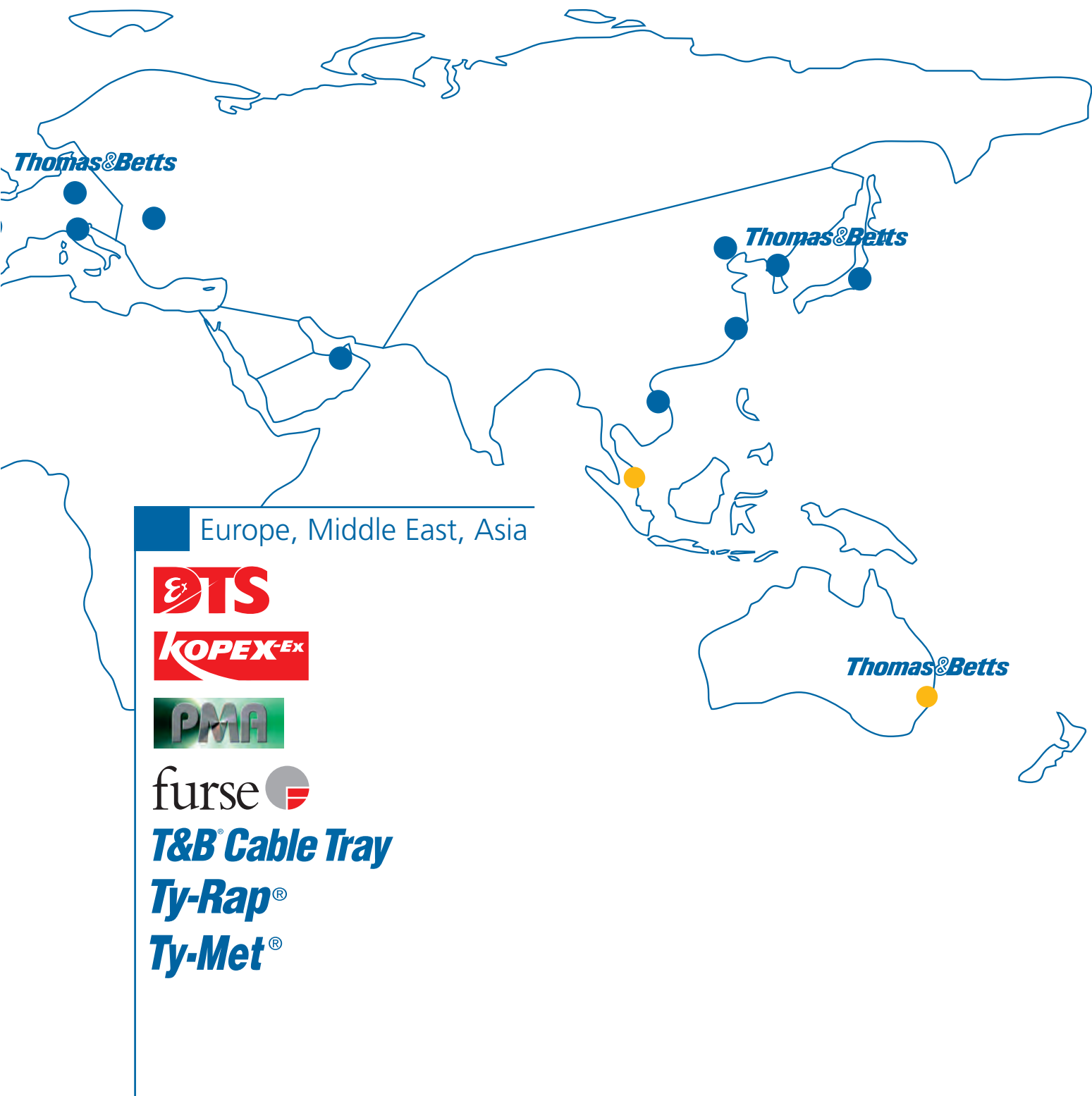

Key of Symbols

DTS & Kopex Ex Symbols

Market Segments



Utilities / Power



Food & Beverage



Marine & Shipbuilding



Onshore & Offshore



Chemical & Pharmaceutical



Mining

Product Characteristics



Ex e



Ex d



Ex n



Ex de



Ex tb



Ex t



Ex tc



Ex tD



Ex nA



Ex ia



Ex eia



Zone 0



Zone 1



Zone 2



Zone 20



Zone 21



Zone 22



Gas IIB



Gas IIC



Dust IIIC



Group I



Group II



Class I



Class II



Division 1



Division 2



IK 09



IK 10



IP 54



IP 56



IP 64



IP 66



IP 67

Battery LED Signals

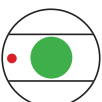

Healthy (test OK)

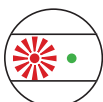

Emergency or Indicator Lamp Fault (must be replaced)



Test in Progress (waiting end of test)

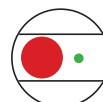

Fault (replace battery)

SATI



Healthy



Emergency or Indicator Lamp Fault



Test in Progress

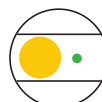

Fault



Thomas and Betts manufacture and design a wide range of electrical equipment for hazardous and hostile environments to ensure the safety of the personnel working in them. The extensive range covers Kopex-Ex metallic and non metallic conduit and fittings and the DTS range of lighting junction and control boxes. These products are approved to a wide range of hazardous area standards including ATEX, IECEx, UL, CSA, GOST and Inmetro.

Thomas & Betts Sales Offices

Thomas & Betts | France / Belgium
 T +33 (0) 1 64 40 27 26
 E france@dtselec.fr

Thomas & Betts | Middle East
 T +971 (0) 4 609 1635
 E enquiry@tnb.com

Thomas & Betts | Switzerland (PMA)
 T +41 44 905 61 11
 E info@pma.ch

Thomas & Betts | Germany / Austria
 T +49 (0) 62 51 669/0
 E europe_inquiry@tnb.com

Thomas & Betts | Netherlands
 T +31 (0) 180 641 888
 E info@vanlien.nl

Thomas & Betts | UK
 T +44 (0) 1675 468 213
 E sales@kopex-ex.com

Thomas & Betts | Italy
 T +39 039 65 79 028

Thomas & Betts | Spain
 T 34 938 45 4570
 E info@pma-es.com

Thomas & Betts | USA
 T 901 252 5000
 E elec_custserv@tnb.com



The content of the Thomas & Betts catalogue has been carefully checked for accuracy at the time of print. However, Thomas & Betts doesn't give any warranty of any kind, express or implied, in this respect and shall not be liable for any loss or damage that may result from any use or as a consequence of any inaccuracies in or any omissions from the information which it may contain.

Copyright Thomas & Betts 2006. Copyright in these pages is owned by Thomas & Betts except where otherwise indicated. No part of this publication may be reproduced, copied or transmitted in any form or by any means, without our prior written permission. Images, trade marks, brands, designs and technology are also protected by other intellectual property rights and may not be reproduced or appropriated in any manner without written permission of their respective owners. Thomas & Betts reserves the right to change and improve any product specifications or other mentions in the catalogue at its own discretion and at any time. These conditions of use are governed by the laws of the Netherlands and the courts of Amsterdam shall have exclusive jurisdiction in any dispute.

Thomas & Betts
 A Member of the ABB Group