



**Surface Mount Fast Recovery Rectifiers**

**Reverse Voltage - 50 to 1000 V**

**Forward Current - 2 A**

**FEATURES**

- For surface mounted applications
- Low profile package
- Glass Passivated Chip Junction
- Easy to pick and place
- Fast reverse recovery time
- Lead free in comply with EU RoHS 2011/65/EU directives

**MECHANICAL DATA**

- Case: SMB
- Terminals: Solderable per MIL-STD-750, Method 2026
- Approx. Weight: 0.091g / 0.003oz

**PINNING**

PIN	DESCRIPTION
1	Cathode
2	Anode

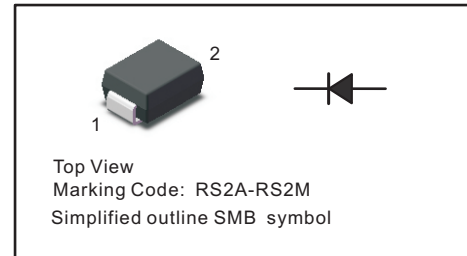

**Absolute Maximum Ratings and Characteristics**

Ratings at 25 °C ambient temperature unless otherwise specified. Single phase, half wave, 60 Hz, resistive or inductive load. For capacitive load, derate current by 20%.

Parameter	Symbols	RS2AB	RS2BB	RS2DB	RS2GB	RS2JB	RS2KB	RS2MB	Units
Maximum Repetitive Peak Reverse Voltage	$V_{RRM}$	50	100	200	400	600	800	1000	V
Maximum RMS voltage	$V_{RMS}$	35	70	140	280	420	560	700	V
Maximum DC Blocking Voltage	$V_{DC}$	50	100	200	400	600	800	1000	V
Maximum Average Forward Rectified Current	$I_{F(AV)}$	2							A
Peak Forward Surge Current 8.3 ms Single Half Sine Wave Superimposed on Rated Load	$I_{FSM}$	60							A
Maximum Forward Voltage at 2 A	$V_F$	1.3							V
Maximum DC Reverse Current at Rated DC Blocking Voltage $T_a = 25\text{ }^\circ\text{C}$ $T_a = 125\text{ }^\circ\text{C}$	$I_R$	5 100							$\mu\text{A}$
Typical Junction Capacitance at $V_R=4\text{V}$ , $f=1\text{MHz}$	$C_j$	28							pF
Maximum Reverse Recovery Time <sup>(1)</sup>	$t_{rr}$	150				250	500		ns
Typical Thermal Resistance <sup>(2)</sup>	$R_{\theta JA}$ $R_{\theta JC}$	60 20							$^\circ\text{C/W}$
Operating and Storage Temperature Range	$T_j, T_{stg}$	-55 ~ +150							$^\circ\text{C}$

( 1 ) Measured with  $I_F = 0.5\text{ A}$ ,  $I_R = 1\text{ A}$ ,  $I_{rr} = 0.25\text{ A}$ .

( 2 ) P.C.B. mounted with 2.0" X 2.0" (5 X 5 cm) copper pad areas.



Fig.1 Forward Current Derating Curve

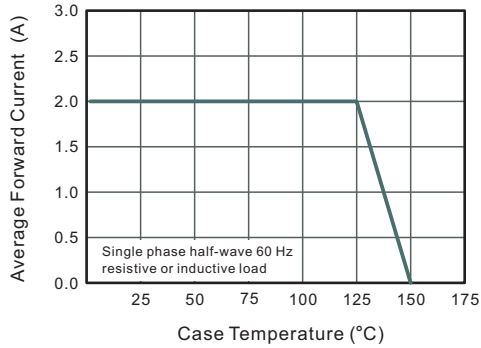

Fig.2 Typical Reverse Characteristics

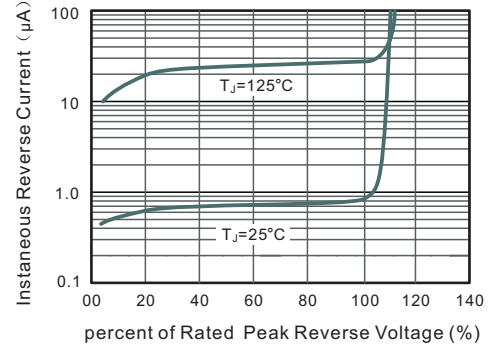

Fig.3 Typical Instantaneous Forward Characteristics

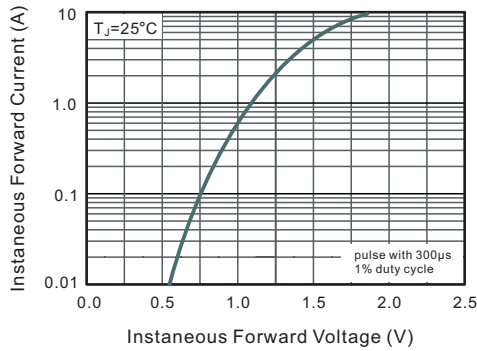

Fig.4 Typical Junction Capacitance

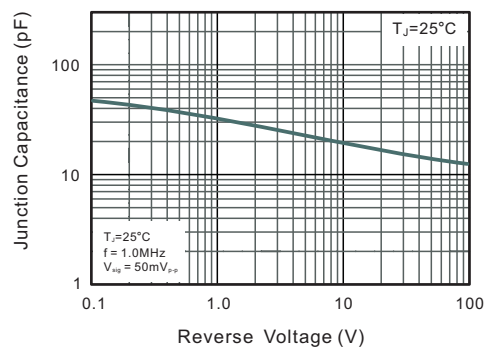
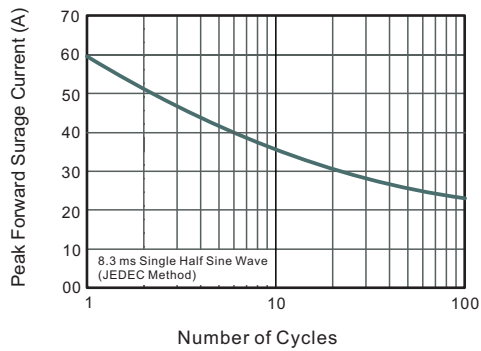

Fig.5 Maximum Non-Repetitive Peak Forward Surge Current





**PACKAGE OUTLINE**

Plastic surface mounted package; 2 leads

SMB

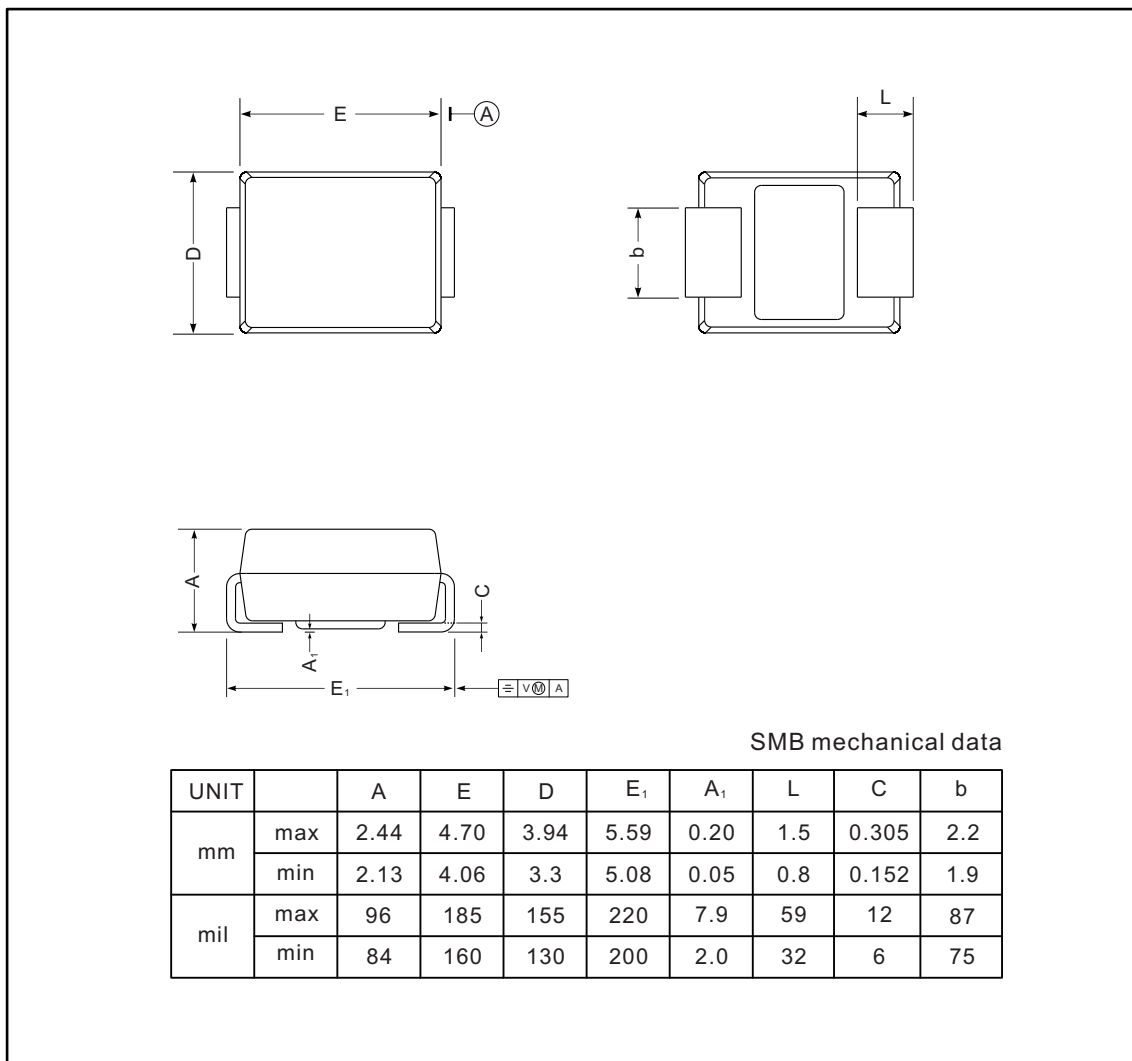

**The recommended mounting pad size**

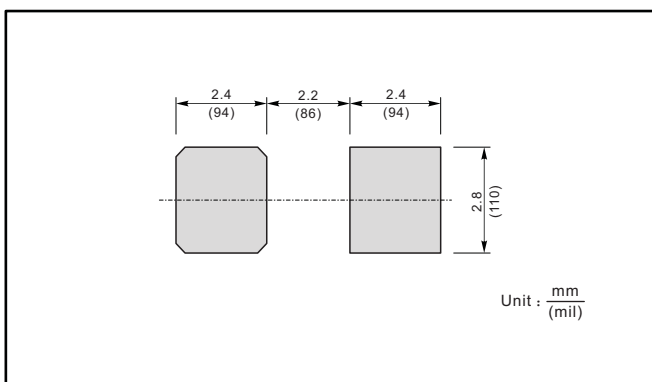

**Marking**

Type number	Marking code
RS2AB	RS2A
RS2BB	RS2B
RS2DB	RS2D
RS2GB	RS2G
RS2JB	RS2J
RS2KB	RS2K
RS2MB	RS2M