

SP-13

To fit 4.0mm hole
chassis 1.6mm

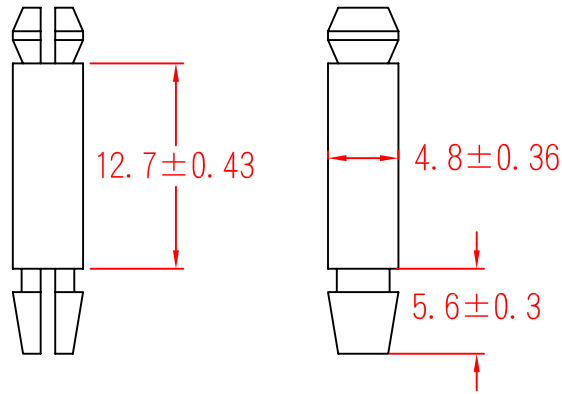

To fit 4.0mm hole
chassis 1.6mm

承認
KSS
97.07.22
邱平裕

審查

製圖
KSS
97.07.22
謝文通

設計

中文名 PC板隔離柱		MATERIAL UL 94V-2 NYLON 66	ITEM NO. SP-13
SCALE	FINISH	NAME P.C.B SUPPORT	
△ (. .)	TOLERANCE AS FIGURE	△ (. . .) 07-22-2008 DATE	REVISIONS K001
使用機種			R.NO.

