

REV.	ECN. NO.	APPD.
X1	12/25'18	Davy Bu
X2	01/10'19	Davy Bu

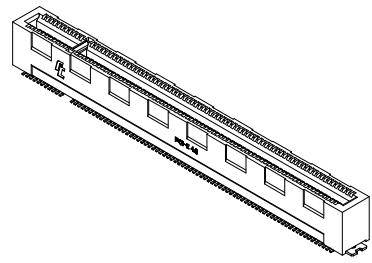

NOTES:

- ELECTRICAL CHARACTERISTICS:
 - CURRENT RATING: 1.1 A PER PIN, 30°C RISE ABOVE AMBIENT.
 - CONTACT RESISTANCE: 30 MILLIOHMS MAX. INITIAL, 50 MILLIOHMS MAX. AFTER TEST.
 - INSULATION RESISTANCE: 1000 MEGOHMS MIN..
 - DIELECTRICAL WITHSTAND VOLTAGE: 500 V AC MIN. AT SEA LEVEL.
- MECHANICAL CHARACTERISTICS:
 - CONTACT INSERTION FORCE: 1.15 N MAX. PER CONTACT PAIR.
 - CONTACT REMOVAL FORCE: 0.15 N MIN. PER CONTACT PAIR.
 - DURABILITY: 50 MATING AND UNMATING CYCLES.
 - CONTACT RETENTION FORCE: 3.43 N MIN.
- ENVIRONMENTAL CHARACTERISTICS:
 - OPERATING TEMPERATURE RANGE: -40°C TO +105°C .
- RECOMMENDED PROCESS: IR REFLOW 245°C, 3~5 s
- PLEASE CONTACT FOXCONN SALES REPRESENTATIVE TO VERIFY PRODUCTION DETAILS & AVAILABILITY

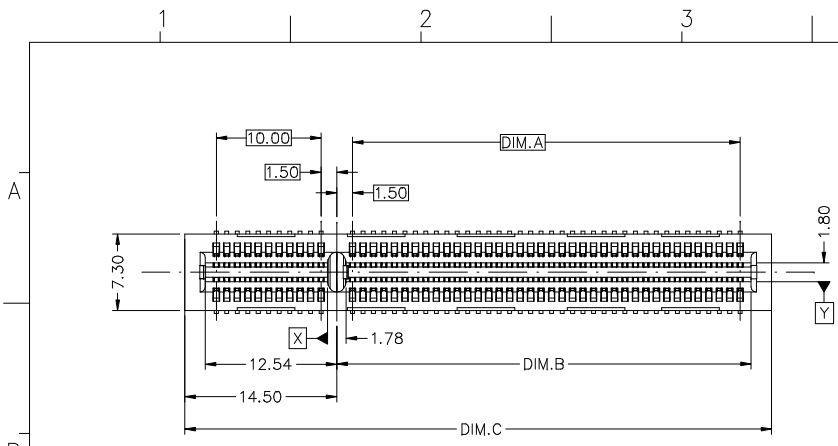
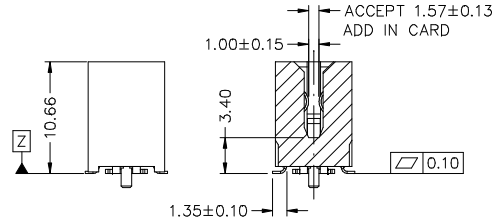
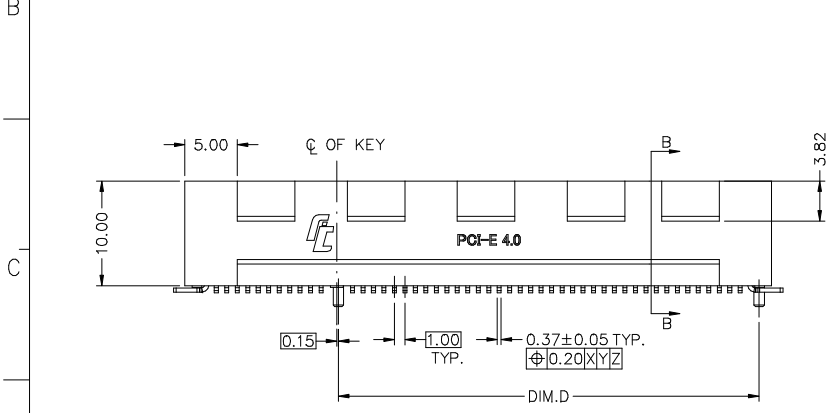

PROD. NO.: 2EF 5 ** * - DA9DN - * *

FIELD PRODUCT SERIES: 2EF= PCI-E GEN 4.0

TERMINAL TYPE: 5= SMT TYPE

NO. OF POS.: B5= 230 POSITIONS

GREEN CODE:
 H: HALOGEN FREE
 LEAD FREE
 RoHS 2.0 COMPLIANT
 F: LEAD FREE
 RoHS 2.0 COMPLIANT

PACKAGE CODE:
 5: MYLAR + TRAY

EXTENSION CODE

CONTACT AREA GOLD PLATING:
 1= GOLD FLASH
 7= 15u" GOLD
 3= 30u" GOLD

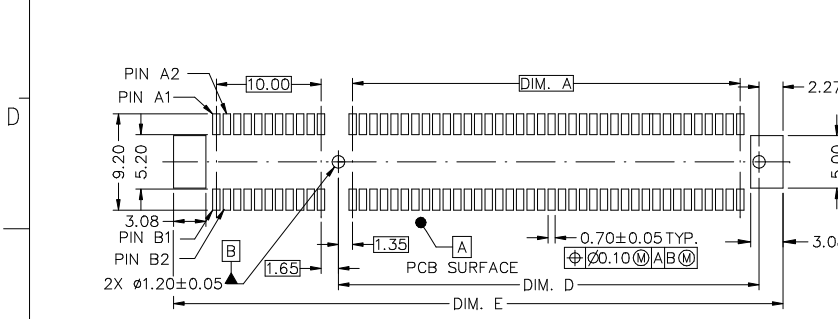

RECOMMENDED PCB LAYOUT

3	CONTACT	COPPY ALLOY PH/BR	50u" NICKEL PLATING OVERALL UNDERPLATED. 100u" MATTE TIN PLATING OVER NICKEL AT TAIL. GOLD PLATING ON CONTACT AREA.
2	HOOK	COPPY ALLOY BRASS	50u" NICKEL PLATING OVERALL UNDERPLATED. 100u" MATTE TIN PLATING OVER NICKEL AT TAIL.
1	HOUSING	THERMOPLASTIC LCP; UL 94V-0	MOLDED BLACK
ITEM	DESCRIPTION	MATERIAL	TREATMENT

X.±	X.*±	UNITS	NAME<INTENDED USE>	 FOXCONN INTERCONNECT TECHNOLOGY LIMITED.
		mm	SMT TYPE PCI-E Gen4.0	
.X± 0.38	.X*±	MAT'L	PART NO.<INTENDED USE>	CLASS: <input type="checkbox"/> CONFIDENTIAL <input type="checkbox"/> SECRET <input checked="" type="checkbox"/> GENERAL
.XX± 0.25	.XX*±	N/A	2EF5***-DA9DN-**	TITLE: CUSTOMER DRAWING
.XXX±	.XXX*±	FINISH	APPD:	DWG NO.: 303-0000-****
THESE DRAWINGS AND SPECIFICATIONS ARE THE PROPERTY OF FOXCONN INTERCONNECT TECHNOLOGY LIMITED AND SHALL NOT BE REPRODUCED, COPIED OR USED IN ANY MANNER WITHOUT THE PRIOR WRITTEN CONSENT OF FOXCONN INTERCONNECT TECHNOLOGY LIMITED.		N/A	Davy Bu 01/10'19	SCALE SHEET REV. N/A 1/3 X2
		Q'TY	CHKD: Johnny Tang 01/10'19 DRAW: Qin Teng 01/10'19	

2EF5B5*-DA9DN-**	103.00	105.54	122.00	106.15	124.15	TO BE DEVELOPED
PART NUMBER	DIM. A	DIM. B	DIM. C	DIM. D	DIM. E	

REV.	ECN. NO.	APPD.

A
B
C
D
E

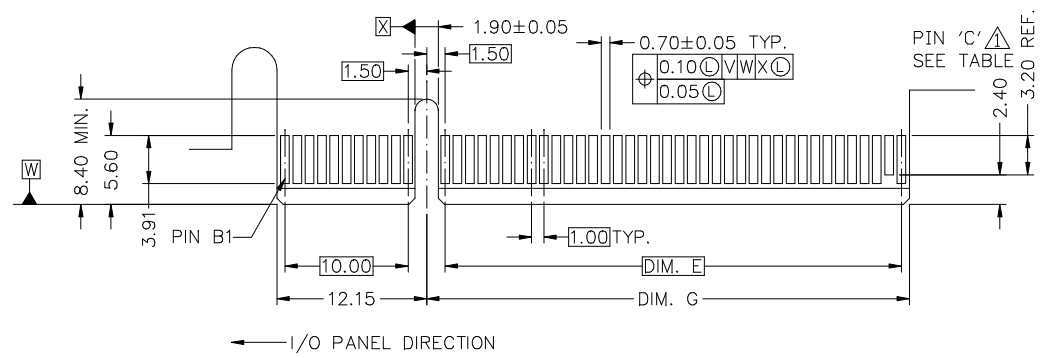

PRIMARY (COMPONENT) SIDE

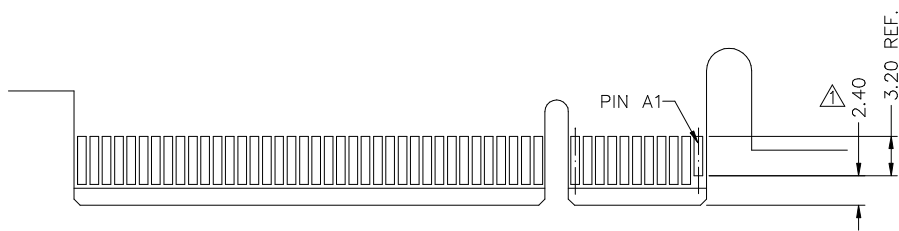

SECONDARY (SOLDER) SIDE

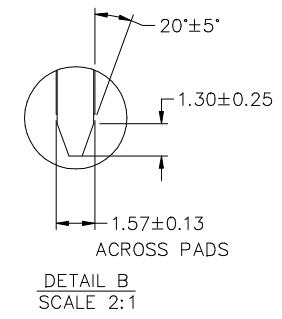
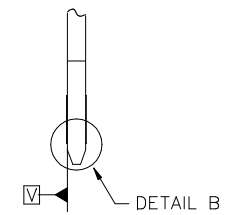

ADD-IN CARD EDGE-FINGER DIMENSIONS

CONNECTOR LINK WIDTH	# POS REF	DIM. E	DIM. G	'C'
X24	230	103.00	105.15	B114

NOTES:

- ① NO TIE PERMITTED FROM CARD EDGE TO LEADING EDGE OF PAD FOR PINS A1 AND 'C'.
- ② CHAMFER EDGES MUST BE FREE OF CUTTING BURRS.

X.±	X.*±	UNITS mm	NAME<INTENDED USE> SMT TYPE PCI-E Gen4.0	 FOXCONN INTERCONNECT TECHNOLOGY LIMITED.
.X± 0.1	.X*± 2°	MAT'L N/A	PART NO.<INTENDED USE> 2EF5***-DA9DN-**	
.XX± 0.05	.XX*±	FINISH N/A	APPD: Davy Bu 01/10'19	CLASS: <input type="checkbox"/> CONFIDENTIAL <input type="checkbox"/> SECRET <input checked="" type="checkbox"/> GENERAL
.XXX±	.XXX*±	Q'TY N/A	CHKD: Johnny Tang 01/10'19 DRAW: Qin Teng 01/10'19	TITLE: CUSTOMER DRAWING
THESE DRAWINGS AND SPECIFICATIONS ARE THE PROPERTY OF FOXCONN INTERCONNECT TECHNOLOGY LIMITED AND SHALL NOT BE REPRODUCED, COPIED OR USED IN ANY MANNER WITHOUT THE PRIOR WRITTEN CONSENT OF FOXCONN INTERCONNECT TECHNOLOGY LIMITED.			DWG NO.: 303-0000-****	SCALE SHEET REV. N/A 2/3 X2

REV.	ECN. NO.	APPD.

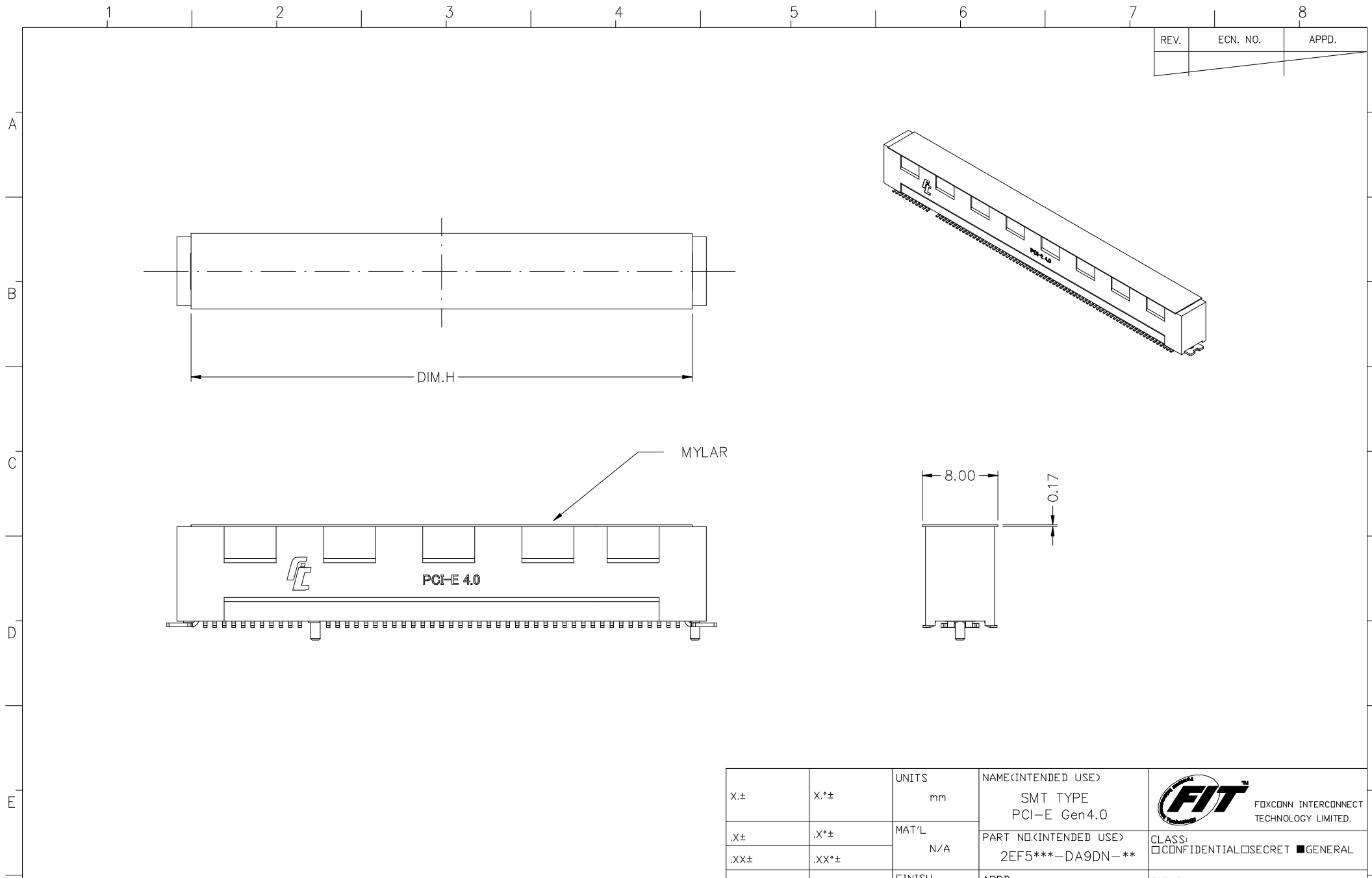

2EF5B5*-DA9DN-**	119
PART NUMBER	DIM. H

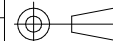
X.±	X.*±	UNITS mm	NAME<INTENDED USE> SMT TYPE PCI-E Gen4.0	 FIT FOXCONN INTERCONNECT TECHNOLOGY LIMITED.		
.X±	.X*±	MAT'L N/A	PART NO.<INTENDED USE> 2EF5***-DA9DN-**		CLASS: <input type="checkbox"/> CONFIDENTIAL <input type="checkbox"/> SECRET <input checked="" type="checkbox"/> GENERAL	
.XX±	.XX*±	FINISH N/A	APPD: Davy Bu 01/10'19	TITLE: CUSTOMER DRAWING		
.XXX±	.XXX*±		Q'TY N/A	CHKD: Johnny Tang 01/10'19 DRAW: Qin Teng 01/10'19	DWG NO.: 303-0000-****	
<small>THESE DRAWINGS AND SPECIFICATIONS ARE THE PROPERTY OF FOXCONN INTERCONNECT TECHNOLOGY LIMITED AND SHALL NOT BE REPRODUCED, COPIED OR USED IN ANY MANNER WITHOUT THE PRIOR WRITTEN CONSENT OF FOXCONN INTERCONNECT TECHNOLOGY LIMITED.</small>				SCALE N/A	SHEET 3/3	REV. X2