

## AMC1311x High-Impedance, 2-V Input, Reinforced Isolated Amplifiers

### 1 Features

- 2-V, high-impedance input voltage range optimized for isolated voltage measurement
- Low offset error and drift:
  - AMC1311B:  $\pm 1.5$  mV (max),  $\pm 10$   $\mu\text{V}/^\circ\text{C}$  (max)
  - AMC1311:  $\pm 9.9$  mV (max),  $\pm 20$   $\mu\text{V}/^\circ\text{C}$  (typ)
- Fixed gain: 1
- Very low gain error and drift:
  - AMC1311B:  $\pm 0.2\%$  (max),  $\pm 40$  ppm/ $^\circ\text{C}$  (max)
  - AMC1311:  $\pm 1\%$  (max),  $\pm 30$  ppm/ $^\circ\text{C}$  (typ)
- Low nonlinearity and drift: 0.01%, 1 ppm/ $^\circ\text{C}$  (typ)
- 3.3-V operation on high-side (AMC1311B)
- Missing high-side supply indication
- Safety-related certifications:
  - 7000- $V_{\text{PK}}$  reinforced isolation per DIN VDE V 0884-11: 2017-01
  - 5000- $V_{\text{RMS}}$  isolation for 1 minute per UL1577
  - CAN/CSA no. 5A-component acceptance service notice and IEC 62368-1 end equipment standard

### 2 Applications

- Isolated voltage sensing in:
  - [Motor drives](#)
  - [Frequency inverters](#)
  - [Uninterruptible power supplies](#)

### 3 Description

The AMC1311 is a precision, isolated amplifier with an output separated from the input circuitry by an isolation barrier that is highly resistant to magnetic interference. This barrier is certified to provide reinforced galvanic isolation of up to 7  $\text{kV}_{\text{PEAK}}$  according to VDE V 0884-11 and UL1577. Used in conjunction with isolated power supplies, this isolated amplifier separates parts of the system that operate on different common-mode voltage levels and protects lower-voltage parts from damage.

The high-impedance input of the AMC1311 is optimized for connection to high-voltage resistive dividers or other voltage signal sources with high output resistance. The excellent performance of the device supports accurate, low temperature drift voltage or temperature sensing and control in closed-loop systems. The integrated missing high-side supply voltage detection feature simplifies system-level design and diagnostics.

The AMC1311 is offered with two performance grade options: the AMC1311B is specified over the extended industrial temperature range of  $-55^\circ\text{C}$  to  $+125^\circ\text{C}$ , and the AMC1311 for operation at  $-40^\circ\text{C}$  to  $+125^\circ\text{C}$ .

#### Device Information<sup>(1)</sup>

PART NUMBER	PACKAGE	BODY SIZE (NOM)
AMC1311x	SOIC (8)	5.85 mm x 7.50 mm

(1) For all available packages, see the orderable addendum at the end of the data sheet.

#### Simplified Schematic

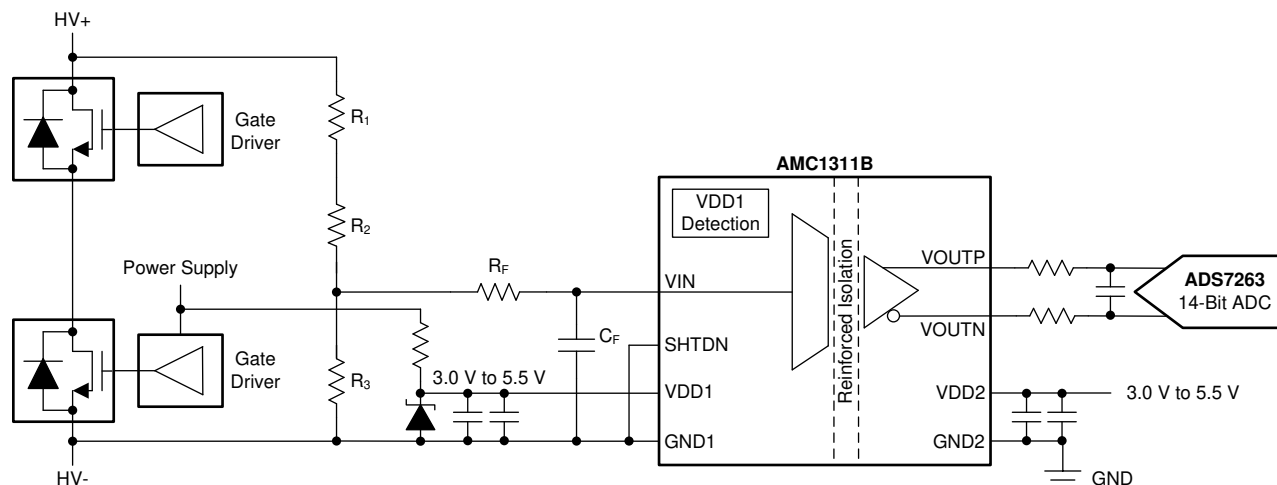

## Table of Contents

<b>1 Features</b> .....	<b>1</b>	8.2 Functional Block Diagram .....	<b>19</b>
<b>2 Applications</b> .....	<b>1</b>	8.3 Feature Description .....	<b>19</b>
<b>3 Description</b> .....	<b>1</b>	8.4 Device Functional Modes .....	<b>21</b>
<b>4 Revision History</b> .....	<b>2</b>	<b>9 Application and Implementation</b> .....	<b>22</b>
<b>5 Device Comparison Table</b> .....	<b>3</b>	9.1 Application Information .....	<b>22</b>
<b>6 Pin Configuration and Functions</b> .....	<b>3</b>	9.2 Typical Application .....	<b>22</b>
<b>7 Specifications</b> .....	<b>4</b>	9.3 What To Do and What Not To Do .....	<b>24</b>
7.1 Absolute Maximum Ratings .....	<b>4</b>	<b>10 Power Supply Recommendations</b> .....	<b>25</b>
7.2 ESD Ratings .....	<b>4</b>	<b>11 Layout</b> .....	<b>26</b>
7.3 Recommended Operating Conditions .....	<b>4</b>	11.1 Layout Guidelines .....	<b>26</b>
7.4 Thermal Information .....	<b>5</b>	11.2 Layout Example .....	<b>26</b>
7.5 Power Ratings .....	<b>5</b>	<b>12 Device and Documentation Support</b> .....	<b>27</b>
7.6 Insulation Specifications .....	<b>6</b>	12.1 Device Support .....	<b>27</b>
7.7 Safety-Related Certifications .....	<b>7</b>	12.2 Documentation Support .....	<b>27</b>
7.8 Safety Limiting Values .....	<b>7</b>	12.3 Receiving Notification of Documentation Updates .....	<b>27</b>
7.9 Electrical Characteristics .....	<b>8</b>	12.4 Support Resources .....	<b>27</b>
7.10 Switching Characteristics .....	<b>10</b>	12.5 Trademarks .....	<b>27</b>
7.11 Insulation Characteristics Curves .....	<b>11</b>	12.6 Electrostatic Discharge Caution .....	<b>27</b>
7.12 Typical Characteristics .....	<b>12</b>	12.7 Glossary .....	<b>28</b>
<b>8 Detailed Description</b> .....	<b>19</b>	<b>13 Mechanical, Packaging, and Orderable Information</b> .....	<b>28</b>
8.1 Overview .....	<b>19</b>		

## 4 Revision History

NOTE: Page numbers for previous revisions may differ from page numbers in the current version.

<b>Changes from Revision A (June 2018) to Revision B</b>	<b>Page</b>
• Changed AMC1311B offset drift from $\pm 15 \mu\text{V}/^\circ\text{C}$ ( <i>max</i> ) to $10 \mu\text{V}/^\circ\text{C}$ ( <i>max</i> ) in <i>Features</i> section .....	<b>1</b>
• Changed AMC1311B gain error from $\pm 0.3\%$ ( <i>max</i> ) to $\pm 0.2\%$ ( <i>max</i> ) and changed AMC1311B gain drift from $\pm 45 \text{ ppm}/^\circ\text{C}$ ( <i>max</i> ) to $\pm 40 \text{ ppm}/^\circ\text{C}$ ( <i>max</i> ) in <i>Features</i> section .....	<b>1</b>
• Changed safety-related certifications details as per ISO standard .....	<b>1</b>
• Changed <i>IEC 60950-1</i> and <i>IEC60065</i> to <i>IEC 62368-1</i> .....	<b>1</b>
• Changed AMC1311B values for $\text{TCV}_{\text{OS}}$ , $\text{E}_{\text{G}}$ , and $\text{TCE}_{\text{G}}$ in <i>Device Comparison Table</i> .....	<b>3</b>
• Changed CLR and CPG values from 9 mm to 8.5 mm .....	<b>6</b>
• Changed <i>Insulation Specifications</i> table per ISO standard .....	<b>6</b>
• Changed <i>Safety-Related Certification</i> table per ISO standard .....	<b>7</b>
• Changed <i>Safety Limiting Values</i> description as per ISO standard .....	<b>7</b>
• Changed $\text{TCV}_{\text{OS}}$ parameter minimum value from $-15 \mu\text{V}/^\circ\text{C}$ to $-10 \mu\text{V}/^\circ\text{C}$ and maximum value from $15 \mu\text{V}/^\circ\text{C}$ to $10 \mu\text{V}/^\circ\text{C}$ for the AMC1311B in the <i>Electrical Characteristics</i> table .....	<b>8</b>
• Changed $\text{E}_{\text{G}}$ parameter minimum value from $-0.3\%$ to $-0.2\%$ and maximum value from $0.3\%$ to $0.2\%$ for the AMC1311B in the <i>Electrical Characteristics</i> table .....	<b>8</b>
• Changed $\text{TCE}_{\text{G}}$ parameter minimum value from $-45 \text{ ppm}/^\circ\text{C}$ to $-40 \text{ ppm}/^\circ\text{C}$ and maximum value from $45 \text{ ppm}/^\circ\text{C}$ to $40 \text{ ppm}/^\circ\text{C}$ for the AMC1311B in the <i>Electrical Characteristics</i> table .....	<b>8</b>
• Changed <i>Step Response of the AMC1311B</i> figure .....	<b>24</b>

  

<b>Changes from Original (December 2017) to Revision A</b>	<b>Page</b>
• Changed <i>Reinforced Isolation Capacitor Lifetime Projection</i> figure .....	<b>11</b>

## 5 Device Comparison Table

PARAMETER	AMC1311B	AMC1311
High-side supply voltage, VDD1	3.0 V to 5.5 V	4.5 V to 5.5 V
Specified ambient temperature, T <sub>A</sub>	–55°C to +125°C	–40°C to +125°C
Input offset voltage, V <sub>OS</sub>	4.5 V ≤ VDD1 ≤ 5.5 V	±1.5 mV
	3.0 V ≤ VDD1 ≤ 5.5 V	±2.5 mV
		±9.9 mV
Input offset drift, TC <sub>V<sub>OS</sub></sub>	±3 μV/°C (typ), ±10 μV/°C (max)	±20 μV/°C (typ)
Gain error, E <sub>G</sub>	±0.2%	±1%
Gain error drift, TC <sub>E<sub>G</sub></sub>	±5 ppm/°C (typ), ±40 ppm/°C (max)	±30 ppm/°C (typ)
Common-mode transient immunity, CMTI	75 kV/μs (min)	15 kV/μs (min)

## 6 Pin Configuration and Functions

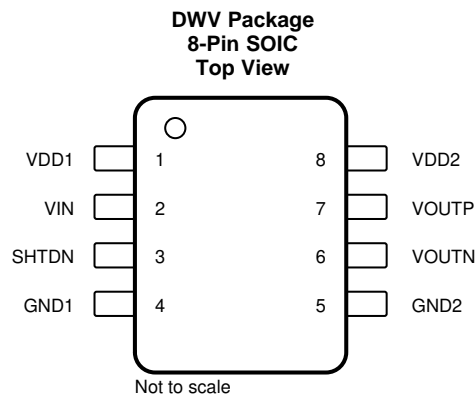

### Pin Functions

PIN		TYPE	DESCRIPTION
NO.	NAME		
1	VDD1	—	High-side power supply, 3.0 V to 5.5 V for the AMC1311B (4.5 V to 5.5 V for the AMC1311), relative to GND1. See the <a href="#">Power Supply Recommendations</a> section for power-supply decoupling recommendations.
2	VIN	I	Analog input
3	SHTDN	I	Shutdown input, active high, with internal pullup resistor (typical value: 100 kΩ)
4	GND1	—	High-side analog ground
5	GND2	—	Low-side analog ground
6	VOUTN	O	Inverting analog output
7	VOUTP	O	Noninverting analog output
8	VDD2	—	Low-side power supply, 3.0 V to 5.5 V, relative to GND2. See the <a href="#">Power Supply Recommendations</a> section for power-supply decoupling recommendations.

## 7 Specifications

### 7.1 Absolute Maximum Ratings

 see <sup>(1)</sup>

		MIN	MAX	UNIT
Power-supply voltage	VDD1 to GND1	−0.3	6.5	V
	VDD2 to GND2	−0.3	6.5	
Input voltage	VIN	GND1 − 6	VDD1 + 0.5	V
	SHTDN	GND1 − 0.5	VDD1 + 0.5	
Output voltage	VOU <sub>TP</sub> , VOU <sub>TN</sub>	GND2 − 0.5	VDD2 + 0.5	V
Input current	Continuous, any pin except power-supply pins	−10	10	mA
Temperature	Junction, T <sub>J</sub>		150	°C
	Storage, T <sub>stg</sub>	−65	150	

- (1) Stresses beyond those listed under *Absolute Maximum Ratings* may cause permanent damage to the device. These are stress ratings only, which do not imply functional operation of the device at these or any other conditions beyond those indicated under *Recommended Operating Conditions*. Exposure to absolute-maximum-rated conditions for extended periods may affect device reliability.

### 7.2 ESD Ratings

			VALUE	UNIT
V <sub>(ESD)</sub>	Electrostatic discharge	Human-body model (HBM), per ANSI/ESDA/JEDEC JS-001 <sup>(1)</sup>	±2000	V
		Charged-device model (CDM), per JEDEC specification JESD22-C101 <sup>(2)</sup>	±1000	

- (1) JEDEC document JEP155 states that 500-V HBM allows safe manufacturing with a standard ESD control process.  
 (2) JEDEC document JEP157 states that 250-V CDM allows safe manufacturing with a standard ESD control process.

### 7.3 Recommended Operating Conditions

over operating ambient temperature range (unless otherwise noted)

			MIN	NOM	MAX	UNIT
<b>POWER SUPPLY</b>						
	High-side power supply	VDD1 to GND1, AMC1311	4.5	5	5.5	V
		VDD1 to GND1, AMC1311B	3.0	5	5.5	
	Low-side power supply	VDD2 to GND2	3.0	3.3	5.5	V
<b>ANALOG INPUT</b>						
	Absolute input voltage	VIN to GND1	−2		VDD1	V
V <sub>FSR</sub>	Specified linear input full-scale voltage	VIN to GND1	−0.1		2	V
V <sub>Clipping</sub>	Input voltage before clipping output	VIN to GND1		2.516		V
<b>DIGITAL INPUT</b>						
	Input voltage	SHTDN	GND1		VDD1	V
<b>TEMPERATURE RANGE</b>						
T <sub>A</sub>	Specified ambient temperature	AMC1311	−40		125	°C
		AMC1311B	−55		125	

## 7.4 Thermal Information

THERMAL METRIC <sup>(1)</sup>		AMC1311x	UNIT
		DWV (SOIC)	
		8 PINS	
$R_{\theta JA}$	Junction-to-ambient thermal resistance	84.6	°C/W
$R_{\theta JC(top)}$	Junction-to-case (top) thermal resistance	28.3	°C/W
$R_{\theta JB}$	Junction-to-board thermal resistance	41.1	°C/W
$\Psi_{JT}$	Junction-to-top characterization parameter	4.9	°C/W
$\Psi_{JB}$	Junction-to-board characterization parameter	39.1	°C/W
$R_{\theta JC(bot)}$	Junction-to-case (bottom) thermal resistance	N/A	°C/W

(1) For more information about traditional and new thermal metrics, see the [Semiconductor and IC Package Thermal Metrics](#) application report.

## 7.5 Power Ratings

PARAMETER		TEST CONDITIONS	VALUE	UNIT
$P_D$	Maximum power dissipation (both sides)	VDD1 = VDD2 = 5.5 V	97.9	mW
		VDD1 = VDD2 = 3.6 V, AMC1311B only	56.16	
$P_{D1}$	Maximum power dissipation (high-side supply)	VDD1 = 5.5 V	53.35	mW
		VDD1 = 3.6 V, AMC1311B only	30.24	
$P_{D2}$	Maximum power dissipation (low-side supply)	VDD2 = 5.5 V	44.55	mW
		VDD2 = 3.6 V	25.92	

## 7.6 Insulation Specifications

over operating ambient temperature range (unless otherwise noted)

PARAMETER		TEST CONDITIONS	VALUE	UNIT
<b>GENERAL</b>				
CLR	External clearance <sup>(1)</sup>	Shortest pin-to-pin distance through air	≥ 8.5	mm
CPG	External creepage <sup>(1)</sup>	Shortest pin-to-pin distance across the package surface	≥ 8.5	mm
DTI	Distance through insulation	Minimum internal gap (internal clearance) of the double insulation (2 × 0.0105 mm)	≥ 0.021	mm
CTI	Comparative tracking index	DIN EN 60112 (VDE 0303-11); IEC 60112	≥ 600	V
	Material group	According to IEC 60664-1	I	
	Overvoltage category per IEC 60664-1	Rated mains voltage ≤ 300 V <sub>RMS</sub>	I-IV	
		Rated mains voltage ≤ 600 V <sub>RMS</sub>	I-IV	
		Rated mains voltage ≤ 1000 V <sub>RMS</sub>	I-III	
<b>DIN VDE V 0884-11: 2017-01<sup>(2)</sup></b>				
V <sub>IORM</sub>	Maximum repetitive peak isolation voltage	At ac voltage (bipolar)	2121	V <sub>PK</sub>
V <sub>IOWM</sub>	Maximum-rated isolation working voltage	At ac voltage (sine wave)	1500	V <sub>RMS</sub>
		At dc voltage	2121	V <sub>DC</sub>
V <sub>IOTM</sub>	Maximum transient isolation voltage	V <sub>TEST</sub> = V <sub>IOTM</sub> , t = 60 s (qualification test)	7000	V <sub>PK</sub>
		V <sub>TEST</sub> = 1.2 × V <sub>IOTM</sub> , t = 1 s (100% production test)	8400	
V <sub>IOSM</sub>	Maximum surge isolation voltage <sup>(3)</sup>	Test method per IEC 60065, 1.2/50-μs waveform, V <sub>TEST</sub> = 1.6 × V <sub>IOSM</sub> = 12800 V <sub>PK</sub> (qualification)	8000	V <sub>PK</sub>
q <sub>pd</sub>	Apparent charge <sup>(4)</sup>	Method a, after input/output safety test subgroup 2 / 3, V <sub>ini</sub> = V <sub>IOTM</sub> , t <sub>ini</sub> = 60 s, V <sub>pd(m)</sub> = 1.2 × V <sub>IORM</sub> = 2545 V <sub>PK</sub> , t <sub>m</sub> = 10 s	≤ 5	pC
		Method a, after environmental tests subgroup 1, V <sub>ini</sub> = V <sub>IOTM</sub> , t <sub>ini</sub> = 60 s, V <sub>pd(m)</sub> = 1.6 × V <sub>IORM</sub> = 3394 V <sub>PK</sub> , t <sub>m</sub> = 10 s	≤ 5	
		Method b1, at routine test (100% production) and preconditioning (type test), V <sub>ini</sub> = V <sub>IOTM</sub> , t <sub>ini</sub> = 1 s, V <sub>pd(m)</sub> = 1.875 × V <sub>IORM</sub> = 3977 V <sub>PK</sub> , t <sub>m</sub> = 1 s	≤ 5	
C <sub>IO</sub>	Barrier capacitance, input to output <sup>(5)</sup>	V <sub>IO</sub> = 0.5 V <sub>PP</sub> at 1 MHz	~1	pF
R <sub>IO</sub>	Insulation resistance, input to output <sup>(5)</sup>	V <sub>IO</sub> = 500 V at T <sub>A</sub> = 25°C	> 10 <sup>12</sup>	Ω
		V <sub>IO</sub> = 500 V at 100°C ≤ T <sub>A</sub> ≤ 125°C	> 10 <sup>11</sup>	
		V <sub>IO</sub> = 500 V at T <sub>S</sub> = 150°C	> 10 <sup>9</sup>	
	Pollution degree		2	
	Climatic category		55/125/21	
<b>UL1577</b>				
V <sub>ISO</sub>	Withstand isolation voltage	V <sub>TEST</sub> = V <sub>ISO</sub> = 5000 V <sub>RMS</sub> or 7000 V <sub>DC</sub> , t = 60 s (qualification), V <sub>TEST</sub> = 1.2 × V <sub>ISO</sub> = 6000 V <sub>RMS</sub> , t = 1 s (100% production test)	5000	V <sub>RMS</sub>

- (1) Apply creepage and clearance requirements according to the specific equipment isolation standards of an application. Care must be taken to maintain the creepage and clearance distance of a board design to ensure that the mounting pads of the isolator on the printed circuit board (PCB) do not reduce this distance. Creepage and clearance on a PCB become equal in certain cases. Techniques such as inserting grooves and ribs on the PCB are used to help increase these specifications.
- (2) This coupler is suitable for *safe electrical insulation* only within the safety ratings. Compliance with the safety ratings shall be ensured by means of suitable protective circuits.
- (3) Testing is carried out in air or oil to determine the intrinsic surge immunity of the isolation barrier.
- (4) Apparent charge is electrical discharge caused by a partial discharge (pd).
- (5) All pins on each side of the barrier are tied together, creating a two-pin device.

## 7.7 Safety-Related Certifications

VDE	UL
Certified according to DIN VDE V 0884-11: 2017-01, DIN EN 62368-1: 2016-05, EN 62368-1: 2014, and IEC 62368-1: 2014	Recognized under 1577 component recognition and CSA component acceptance NO 5 programs
Reinforced insulation	Single protection
Certificate number: 40040142	File number: E181974

## 7.8 Safety Limiting Values

Safety limiting intends to minimize potential damage to the isolation barrier upon failure of input or output circuitry.

PARAMETER		TEST CONDITIONS	MIN	TYP	MAX	UNIT
I <sub>S</sub>	Safety input, output, or supply current	R <sub>θJA</sub> = 84.6°C/W, T <sub>J</sub> = 150°C, T <sub>A</sub> = 25°C, VDD1 = VDD2 = 5.5 V, see <a href="#">Figure 2</a>			268	mA
		R <sub>θJA</sub> = 84.6°C/W, T <sub>J</sub> = 150°C, T <sub>A</sub> = 25°C, VDD1 = VDD2 = 3.6 V, AMC1311B only, see <a href="#">Figure 2</a>			410	
P <sub>S</sub>	Safety input, output, or total power <sup>(1)</sup>	R <sub>θJA</sub> = 84.6°C/W, T <sub>J</sub> = 150°C, T <sub>A</sub> = 25°C, see <a href="#">Figure 3</a>			1477	mW
T <sub>S</sub>	Maximum safety temperature				150	°C

- (1) The maximum safety temperature, T<sub>S</sub>, has the same value as the maximum junction temperature, T<sub>J</sub>, specified for the device. The I<sub>S</sub> and P<sub>S</sub> parameters represent the safety current and safety power, respectively. Do not exceed the maximum limits of I<sub>S</sub> and P<sub>S</sub>. These limits vary with the ambient temperature, T<sub>A</sub>.

The junction-to-air thermal resistance, R<sub>θJA</sub>, in the Thermal Information table is that of a device installed on a high-K test board for leaded surface-mount packages. Use these equations to calculate the value for each parameter:

$T_J = T_A + R_{\theta JA} \times P$ , where P is the power dissipated in the device.

$T_{J(max)} = T_S = T_A + R_{\theta JA} \times P_S$ , where T<sub>J(max)</sub> is the maximum junction temperature.

$P_S = I_S \times VDD1_{max} + I_S \times VDD2_{max}$ , where VDD1<sub>max</sub> is the maximum high-side voltage and VDD2<sub>max</sub> is the maximum low-side supply voltage.

## 7.9 Electrical Characteristics

minimum and maximum specifications of the AMC1311 apply from  $T_A = -40^\circ\text{C}$  to  $+125^\circ\text{C}$ ,  $V_{DD1} = 4.5\text{ V}$  to  $5.5\text{ V}$ ,  $V_{DD2} = 3.0\text{ V}$  to  $5.5\text{ V}$ ,  $V_{IN} = -0.1\text{ V}$  to  $2\text{ V}$ , and  $\text{SHTDN} = \text{GND1} = 0\text{ V}$ ; minimum and maximum specifications of the AMC1311B apply from  $T_A = -55^\circ\text{C}$  to  $+125^\circ\text{C}$ ,  $V_{DD1} = 3.0\text{ V}$  to  $5.5\text{ V}$ ,  $V_{DD2} = 3.0\text{ V}$  to  $5.5\text{ V}$ ,  $V_{IN} = -0.1\text{ V}$  to  $2\text{ V}$ , and  $\text{SHTDN} = \text{GND1} = 0\text{ V}$ ; typical specifications are at  $T_A = 25^\circ\text{C}$ ,  $V_{DD1} = 5\text{ V}$ , and  $V_{DD2} = 3.3\text{ V}$  (unless otherwise noted)

PARAMETER		TEST CONDITIONS	MIN	TYP	MAX	UNIT
<b>ANALOG INPUT</b>						
$V_{OS}$	Input offset voltage <sup>(1)</sup>	AMC1311, initial, at $T_A = 25^\circ\text{C}$ , $V_{IN} = \text{GND1}$	-9.9	$\pm 0.4$	9.9	mV
		AMC1311B, initial, at $T_A = 25^\circ\text{C}$ , $V_{IN} = \text{GND1}$ , $4.5\text{ V} \leq V_{DD1} \leq 5.5\text{ V}$	-1.5	$\pm 0.4$	1.5	
		AMC1311B, initial, at $T_A = 25^\circ\text{C}$ , $V_{IN} = \text{GND1}$ , $3.0\text{ V} \leq V_{DD1} \leq 5.5\text{ V}$ <sup>(2)</sup>	-2.5	-1.1	2.5	
$TCV_{OS}$	Input offset drift <sup>(1)</sup>	AMC1311		$\pm 20$		$\mu\text{V}/^\circ\text{C}$
		AMC1311B	-10	$\pm 3$	10	
$C_{IN}$	Input capacitance <sup>(3)</sup>	$f_{IN} = 275\text{ kHz}$		7		pF
$R_{IN}$	Input resistance <sup>(3)</sup>			1		G $\Omega$
$I_{IB}$	Input bias current	$V_{IN} = \text{GND1}$	-15	3.5	15	nA
$TCI_{IB}$	Input bias current drift			$\pm 10$		$\text{pA}/^\circ\text{C}$
<b>ANALOG OUTPUT</b>						
	Nominal gain			1		
$E_G$	Gain error <sup>(1)</sup>	AMC1311, initial, at $T_A = 25^\circ\text{C}$	-1%	0.4%	1%	
		AMC1311B, initial, at $T_A = 25^\circ\text{C}$	-0.2%	$\pm 0.05\%$	0.2%	
$TCE_G$	Gain error drift <sup>(1)</sup>	AMC1311		$\pm 30$		ppm/ $^\circ\text{C}$
		AMC1311B	-40	$\pm 5$	40	
	Nonlinearity <sup>(1)</sup>		-0.04%	$\pm 0.01\%$	0.04%	
	Nonlinearity drift			1		ppm/ $^\circ\text{C}$
$\text{THD}$	Total harmonic distortion	$V_{IN} = 2\text{ V}$ , $f_{IN} = 10\text{ kHz}$ , $\text{BW} = 100\text{ kHz}$		-87		dB
	Output noise	$V_{IN} = \text{GND1}$ , $\text{BW} = 100\text{ kHz}$		220		$\mu\text{V}_{\text{RMS}}$
$\text{SNR}$	Signal-to-noise ratio	$V_{IN} = 2\text{ V}$ , $f_{IN} = 1\text{ kHz}$ , $\text{BW} = 10\text{ kHz}$	79	82.6		dB
		$V_{IN} = 2\text{ V}$ , $f_{IN} = 10\text{ kHz}$ , $\text{BW} = 100\text{ kHz}$		70.9		
$\text{PSRR}$	Power-supply rejection ratio <sup>(4)</sup>	PSRR vs $V_{DD1}$ , at dc		-65		dB
		PSRR vs $V_{DD1}$ , 100-mV and 10-kHz ripple		-65		
		PSRR vs $V_{DD2}$ , at dc		-85		
		PSRR vs $V_{DD2}$ , 100-mV and 10-kHz ripple		-70		
$V_{\text{CMout}}$	Common-mode output voltage		1.39	1.44	1.49	V
$V_{\text{FAILSAFE}}$	Failsafe differential output voltage	$V_{\text{OUTP}} - V_{\text{OUTN}}$ , $\text{SHTDN} = \text{high}$ , or $V_{DD1} \leq V_{DD1_{\text{UV}}}$ , or $V_{DD1}$ missing		-2.6	-2.5	V
$\text{BW}$	Output bandwidth	AMC1311	100	220		kHz
		AMC1311B	220	275		
$R_{\text{OUT}}$	Output resistance	On $V_{\text{OUTP}}$ or $V_{\text{OUTN}}$		< 0.2		$\Omega$
	Output short-circuit current			$\pm 13$		mA
$\text{CMTI}$	Common-mode transient immunity	$ \text{GND1} - \text{GND2}  = 1\text{ kV}$ , AMC1311	15	30		kV/ $\mu\text{s}$
		$ \text{GND1} - \text{GND2}  = 1\text{ kV}$ , AMC1311B	75	140		

(1) The typical value includes one sigma statistical variation.

(2) The typical value is at  $V_{DD1} = 3.3\text{ V}$ .

(3) See the [Analog Input](#) section for more details.

(4) This parameter is output referred.



## Electrical Characteristics (continued)

minimum and maximum specifications of the AMC1311 apply from  $T_A = -40^\circ\text{C}$  to  $+125^\circ\text{C}$ ,  $V_{DD1} = 4.5\text{ V}$  to  $5.5\text{ V}$ ,  $V_{DD2} = 3.0\text{ V}$  to  $5.5\text{ V}$ ,  $V_{IN} = -0.1\text{ V}$  to  $2\text{ V}$ , and  $\text{SHTDN} = \text{GND1} = 0\text{ V}$ ; minimum and maximum specifications of the AMC1311B apply from  $T_A = -55^\circ\text{C}$  to  $+125^\circ\text{C}$ ,  $V_{DD1} = 3.0\text{ V}$  to  $5.5\text{ V}$ ,  $V_{DD2} = 3.0\text{ V}$  to  $5.5\text{ V}$ ,  $V_{IN} = -0.1\text{ V}$  to  $2\text{ V}$ , and  $\text{SHTDN} = \text{GND1} = 0\text{ V}$ ; typical specifications are at  $T_A = 25^\circ\text{C}$ ,  $V_{DD1} = 5\text{ V}$ , and  $V_{DD2} = 3.3\text{ V}$  (unless otherwise noted)

PARAMETER		TEST CONDITIONS	MIN	TYP	MAX	UNIT
<b>DIGITAL INPUT (SHTDN Pin: CMOS Logic Family, CMOS With Schmitt-Trigger)</b>						
$I_{IN}$	Input current	$\text{GND1} \leq V_{\text{SHTDN}} \leq V_{DD1}$	-70		1	$\mu\text{A}$
$C_{IN}$	Input capacitance			5		$\text{pF}$
$V_{IH}$	High-level input voltage		$0.7 \times V_{DD1}$		$V_{DD1} + 0.3$	$\text{V}$
$V_{IL}$	Low-level input voltage		-0.3		$0.3 \times V_{DD1}$	$\text{V}$
<b>POWER SUPPLY</b>						
$V_{DD1UV}$	$V_{DD1}$ undervoltage detection threshold voltage	$V_{DD1}$ falling	1.75	2.53	2.7	$\text{V}$
$I_{DD1}$	High-side supply current	AMC1311B only, $3.0\text{ V} \leq V_{DD1} \leq 3.6\text{ V}$ , SHTDN = low		6	8.4	$\text{mA}$
		$4.5\text{ V} \leq V_{DD1} \leq 5.5\text{ V}$ , SHTDN = low		7.1	9.7	
		SHTDN = high		1.3		$\mu\text{A}$
$I_{DD2}$	Low-side supply current	$3.0\text{ V} \leq V_{DD2} \leq 3.6\text{ V}$		5.3	7.2	$\text{mA}$
		$4.5\text{ V} \leq V_{DD2} \leq 5.5\text{ V}$		5.9	8.1	

### 7.10 Switching Characteristics

over operating ambient temperature range (unless otherwise noted)

PARAMETER		TEST CONDITIONS	MIN	TYP	MAX	UNIT
$t_r$	Rise time of VOUTP, VOUTN	See Figure 1		1.3		$\mu\text{s}$
$t_f$	Fall time of VOUTP, VOUTN	See Figure 1		1.3		$\mu\text{s}$
	VIN to VOUTN, VOUTP signal delay (50% – 10%)	AMC1311, unfiltered output, see Figure 1		1.5	2.5	$\mu\text{s}$
		AMC1311B, unfiltered output, see Figure 1		1.0	1.5	
	VIN to VOUTN, VOUTP signal delay (50% – 50%)	AMC1311, unfiltered output, see Figure 1		2.1	3.1	$\mu\text{s}$
		AMC1311B, unfiltered output, see Figure 1		1.6	2.1	
	VIN to VOUTN, VOUTP signal delay (50% – 90%)	AMC1311, unfiltered output, see Figure 1		3.0	4.0	$\mu\text{s}$
		AMC1311B, unfiltered output, see Figure 1		2.5	3.0	
$t_{AS}$	Analog settling time	VDD1 step to 3.0 V with VDD2 $\geq$ 3.0 V, to VOUTP, VOUTN valid, 0.1% settling		50	100	$\mu\text{s}$
$t_{EN}$	Device enable time	SHTDN high to low		50	100	$\mu\text{s}$
$t_{SHTDN}$	Shutdown time	SHTDN low to high		3	10	$\mu\text{s}$

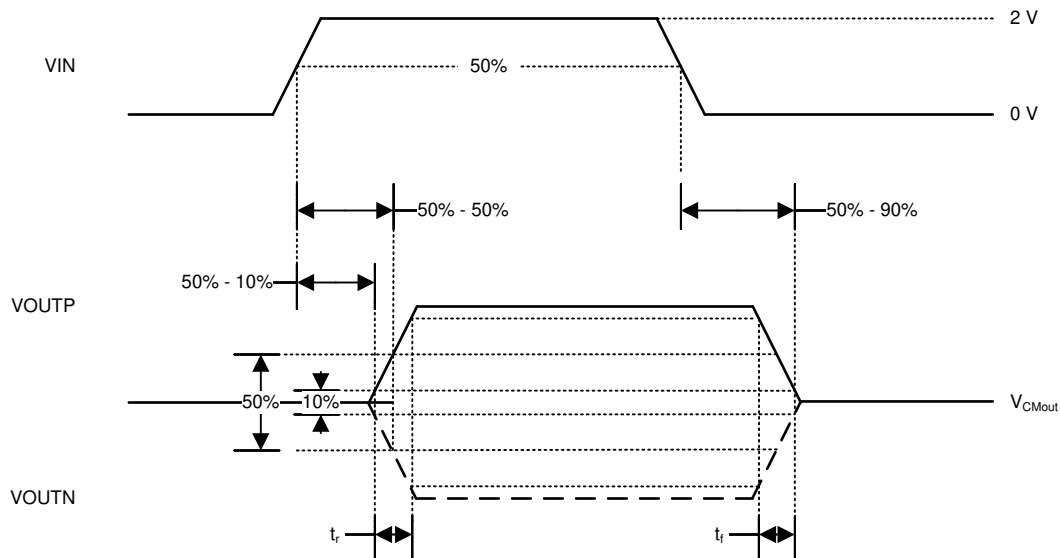
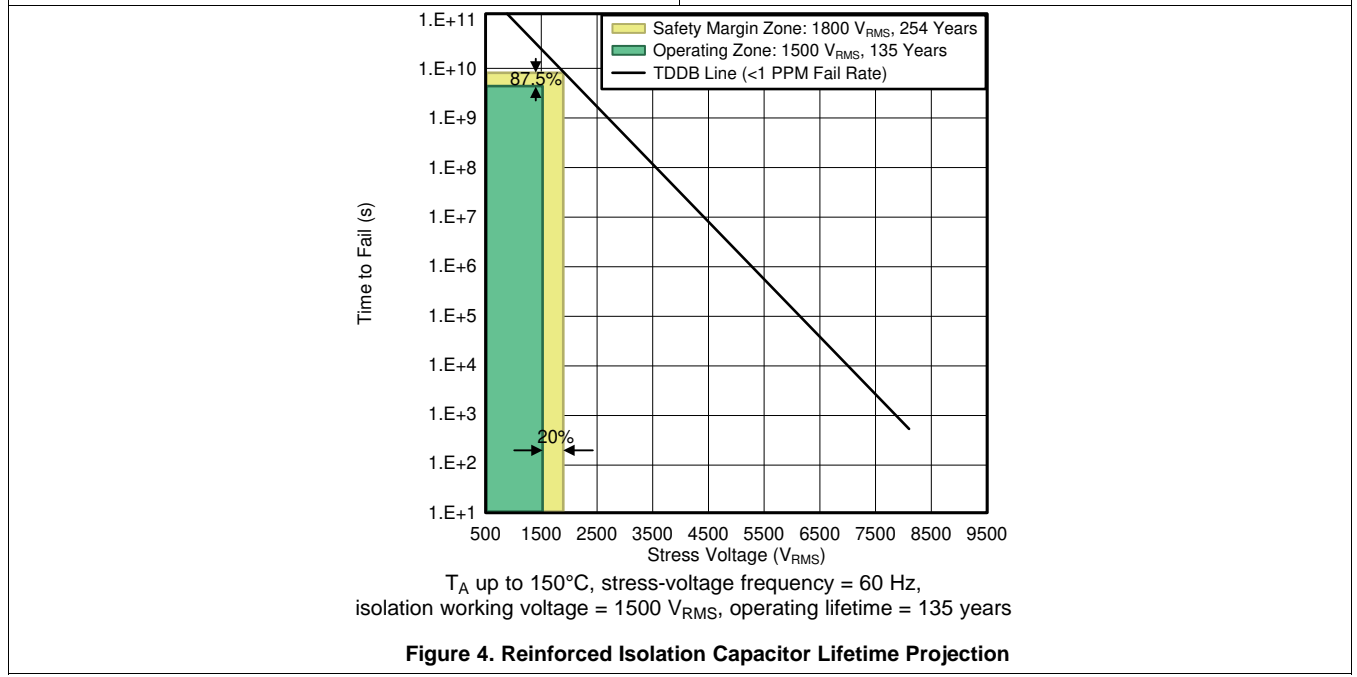
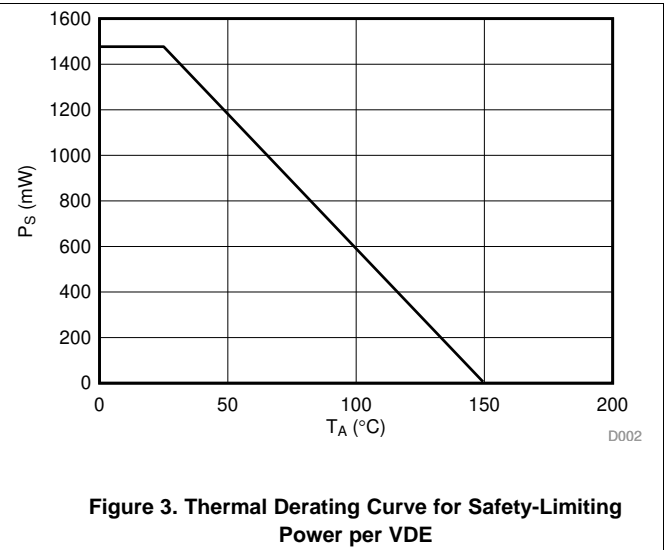
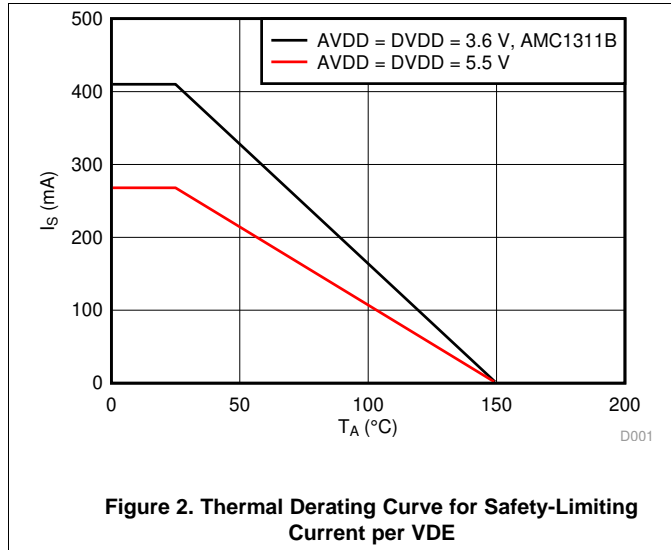

Figure 1. Rise, Fall, and Delay Time Waveforms

### 7.11 Insulation Characteristics Curves



## 7.12 Typical Characteristics

at VDD1 = 5 V, VDD2 = 3.3 V, SHTDN = 0 V,  $f_{IN}$  = 10 kHz, and BW = 100 kHz (unless otherwise noted)

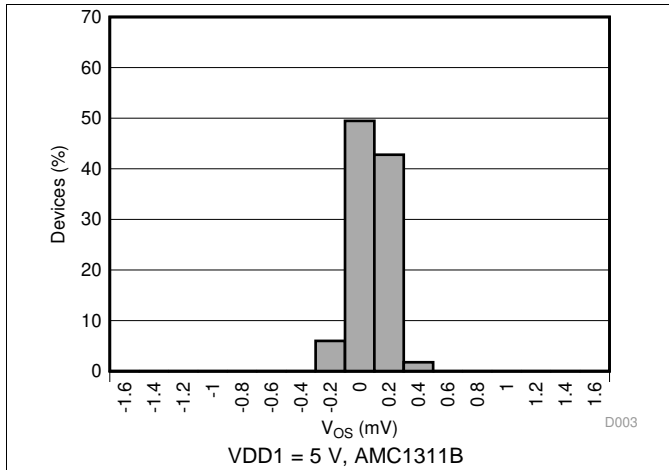

Figure 5. Input Offset Voltage Histogram

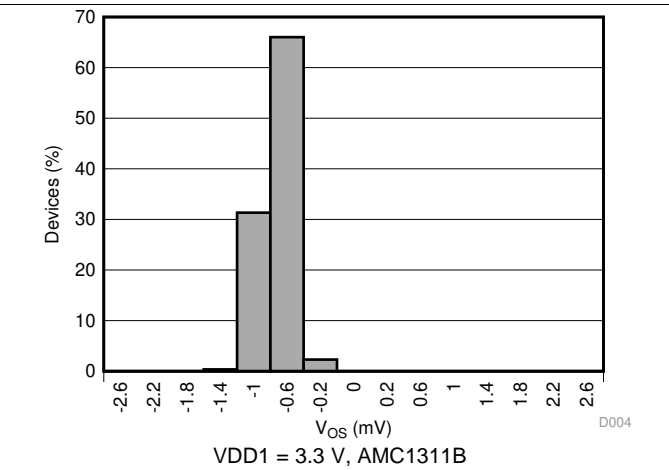

Figure 6. Input Offset Voltage Histogram

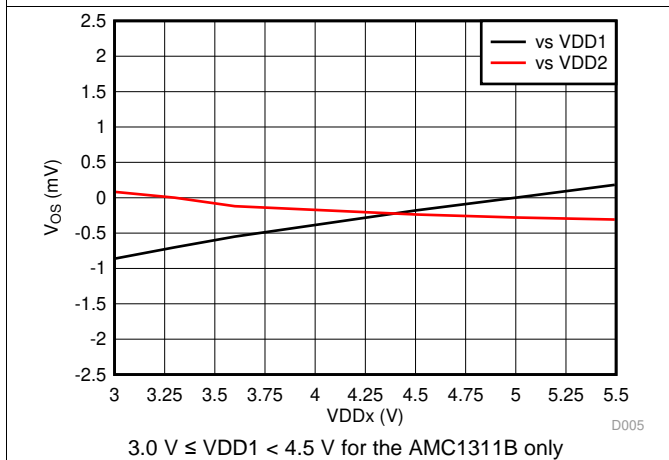

Figure 7. Input Offset Voltage vs Supply Voltage

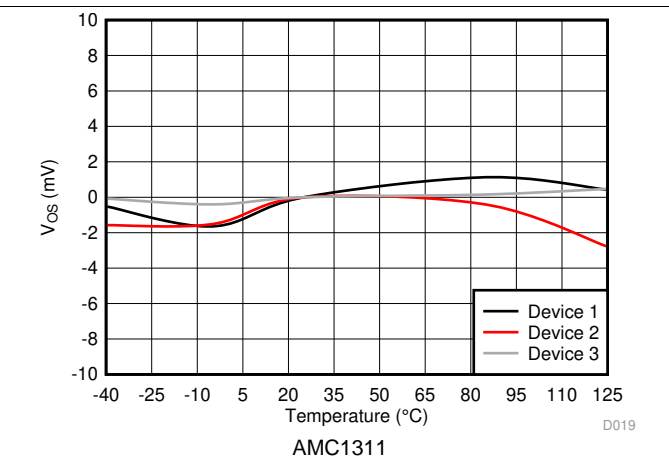

Figure 8. Input Offset Voltage vs Temperature

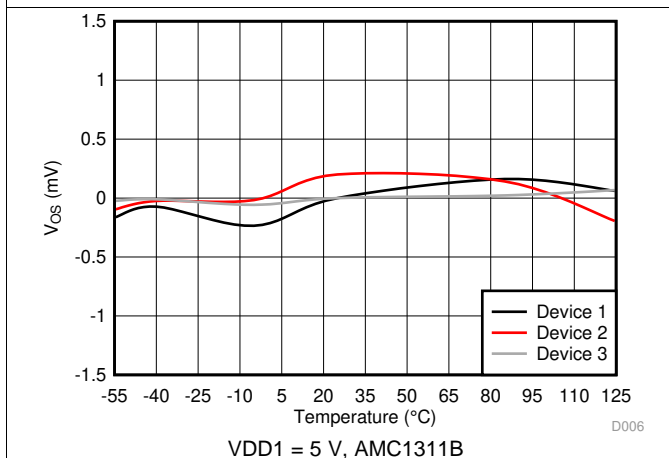

Figure 9. Input Offset Voltage vs Temperature

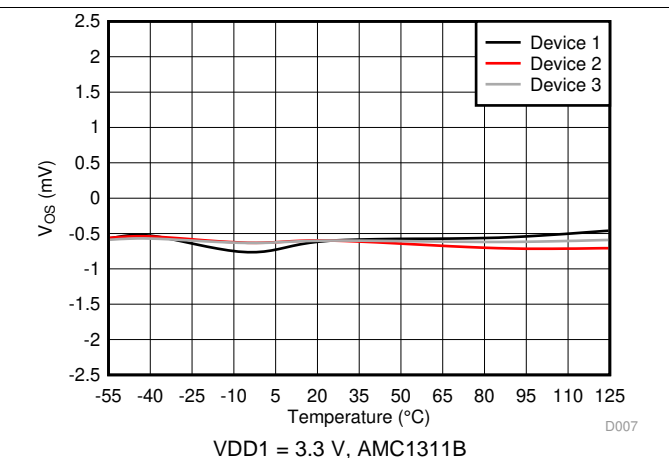

Figure 10. Input Offset Voltage vs Temperature

Typical Characteristics (continued)

at VDD1 = 5 V, VDD2 = 3.3 V, SHTDN = 0 V,  $f_{IN} = 10$  kHz, and BW = 100 kHz (unless otherwise noted)

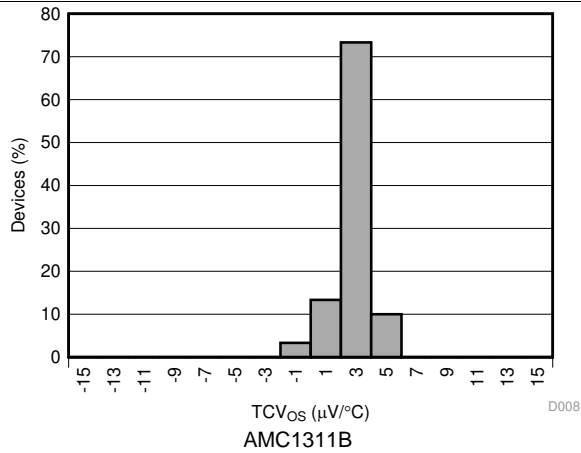

Figure 11. Input Offset Drift Histogram

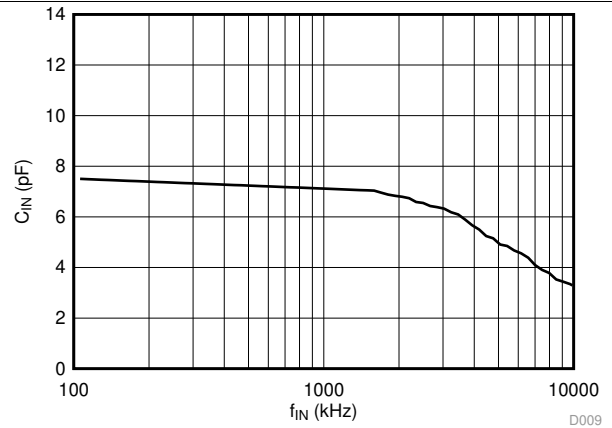
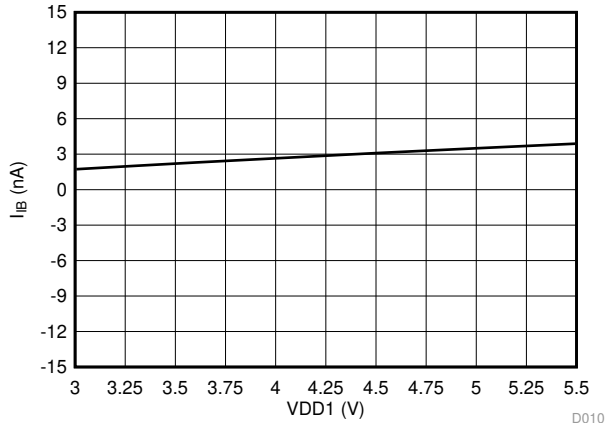
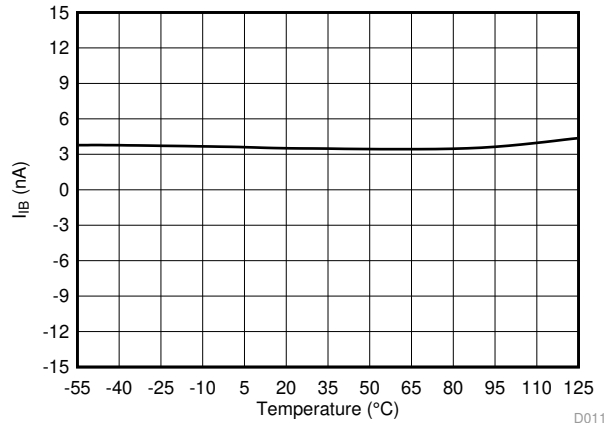

Figure 12. Input Capacitance vs Input Signal Frequency



3.0 V ≤ VDD1 < 4.5 V for the AMC1311B only

Figure 13. Input Bias Current vs High-Side Supply Voltage



-55°C ≤ T<sub>A</sub> < -40°C for the AMC1311B only

Figure 14. Input Bias Current vs Temperature

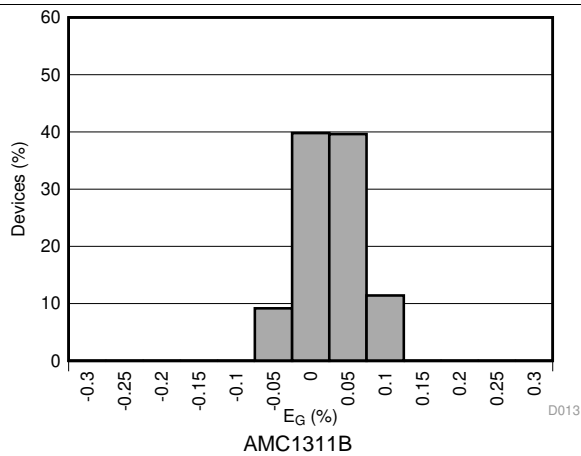
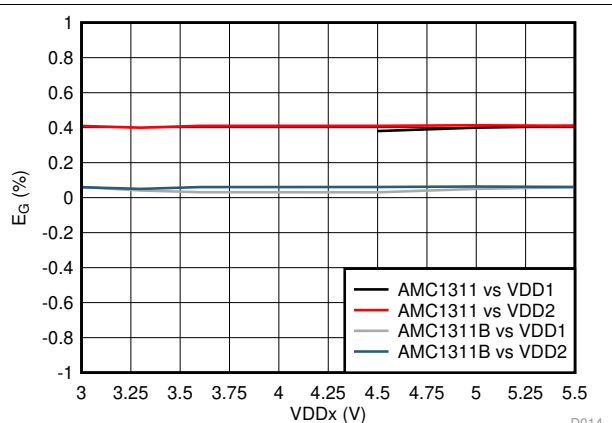

Figure 15. Gain Error Histogram



3.0 V ≤ VDD1 < 4.5 V for the AMC1311B only

Figure 16. Gain Error vs Supply Voltage

Typical Characteristics (continued)

at VDD1 = 5 V, VDD2 = 3.3 V, SHTDN = 0 V,  $f_{IN} = 10$  kHz, and BW = 100 kHz (unless otherwise noted)

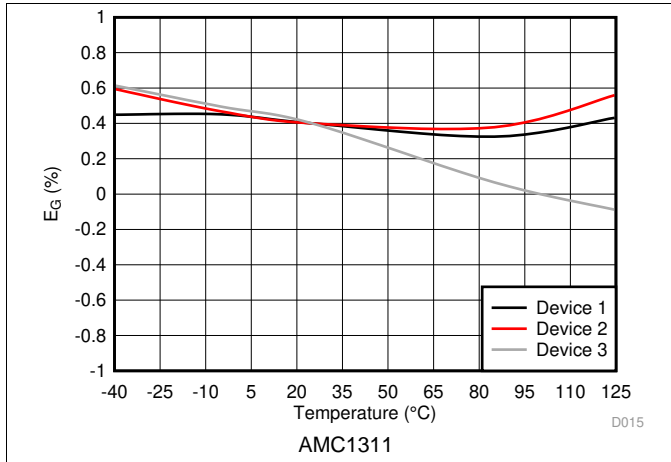

Figure 17. Gain Error vs Temperature

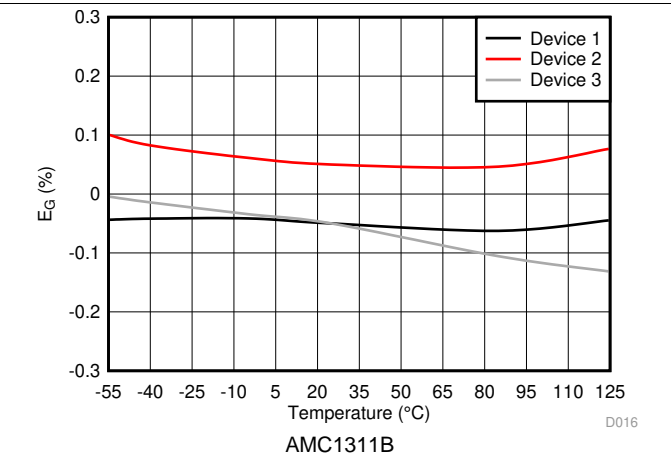

Figure 18. Gain Error vs Temperature

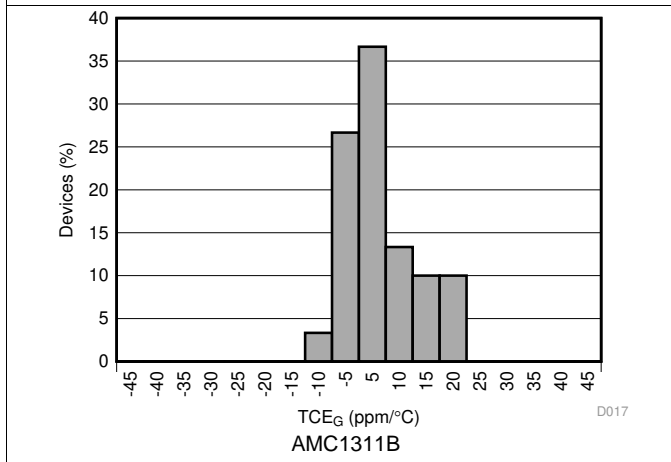

Figure 19. Gain Error Drift Histogram

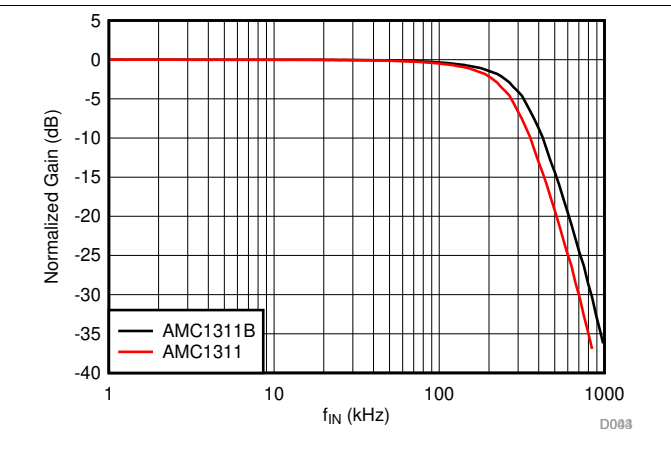

Figure 20. Normalized Gain vs Input Frequency

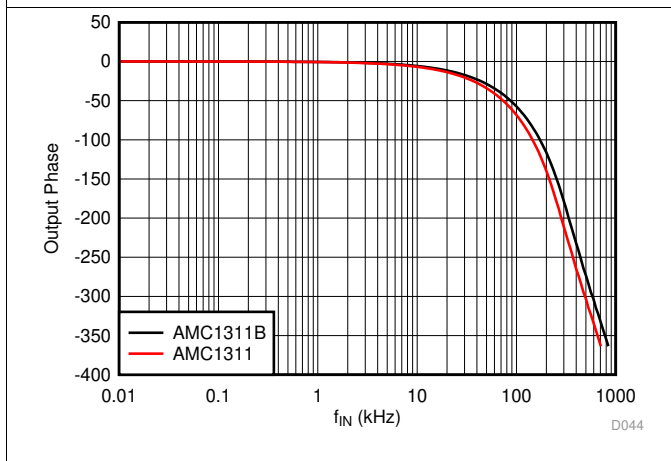

Figure 21. Output Phase vs Input Frequency

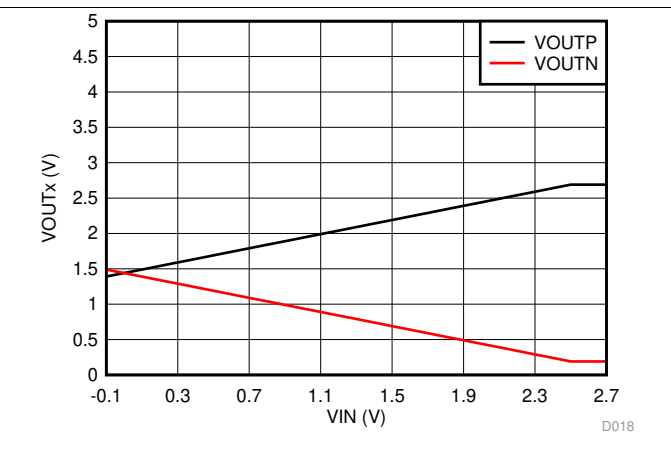
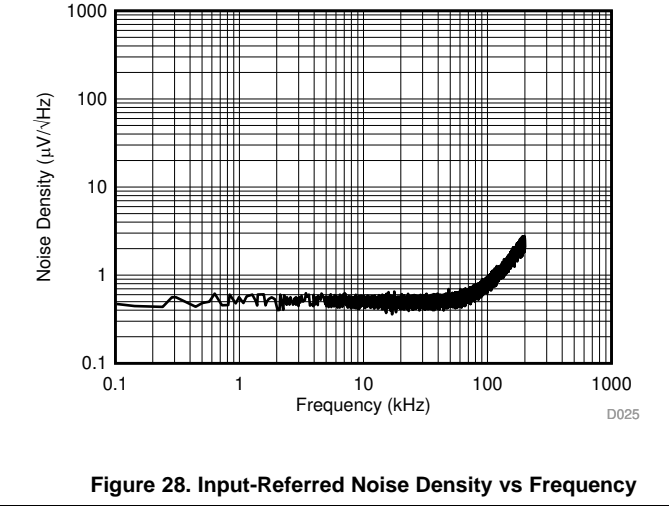
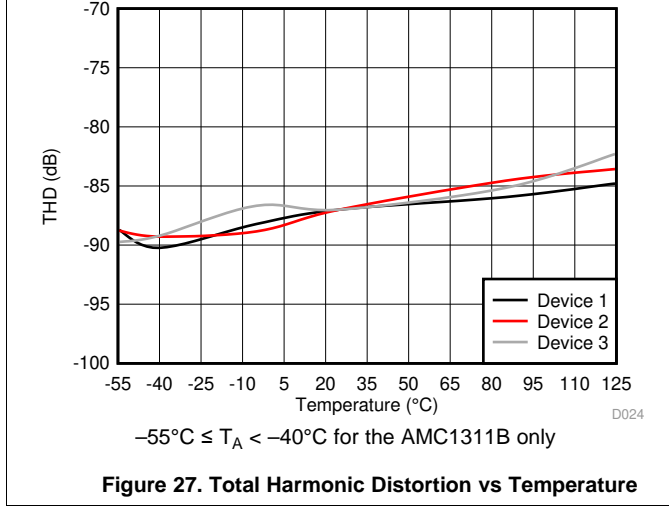
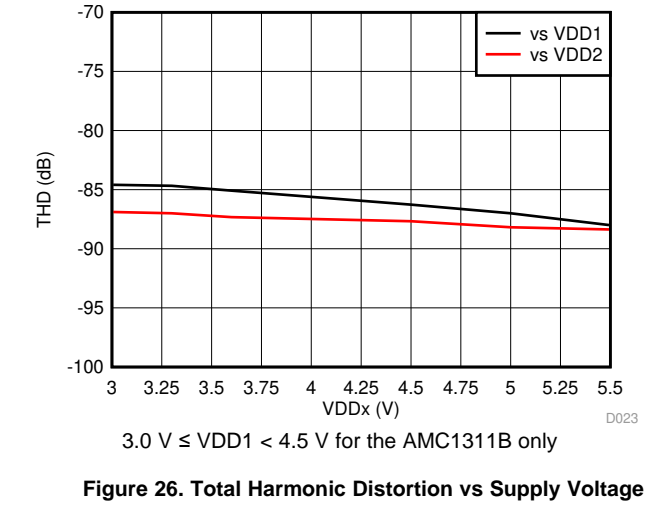
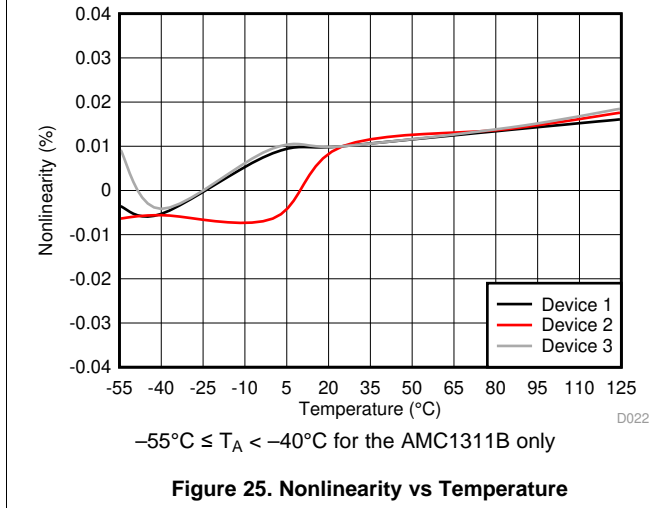
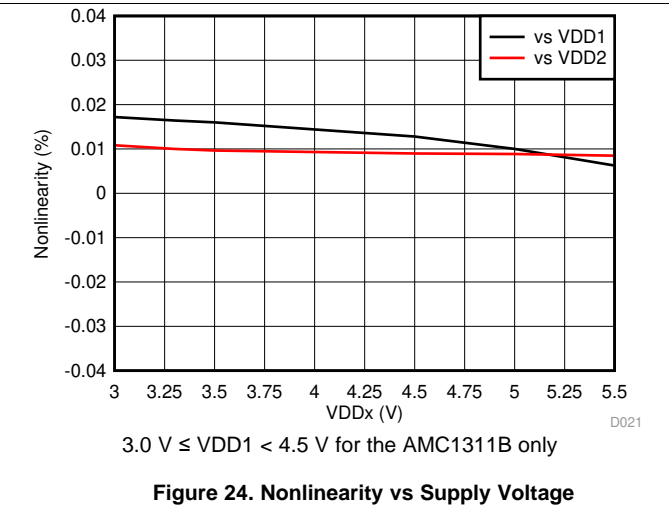
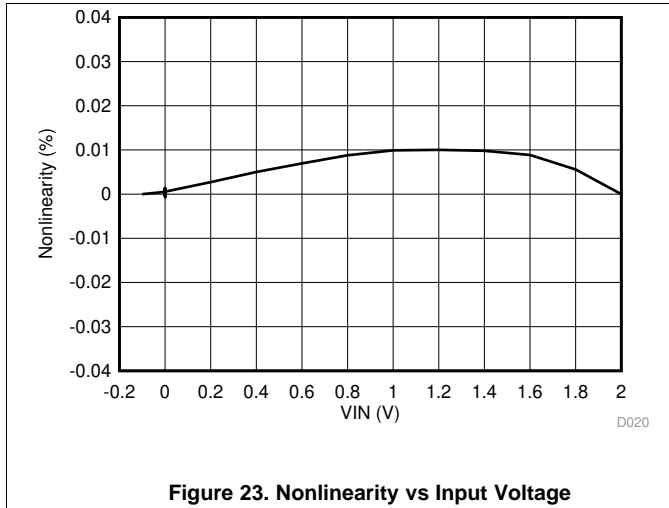

Figure 22. Output Voltage vs Input Voltage

Typical Characteristics (continued)

at VDD1 = 5 V, VDD2 = 3.3 V, SHTDN = 0 V,  $f_{IN} = 10$  kHz, and BW = 100 kHz (unless otherwise noted)



### Typical Characteristics (continued)

at VDD1 = 5 V, VDD2 = 3.3 V, SHTDN = 0 V,  $f_{IN} = 10$  kHz, and BW = 100 kHz (unless otherwise noted)

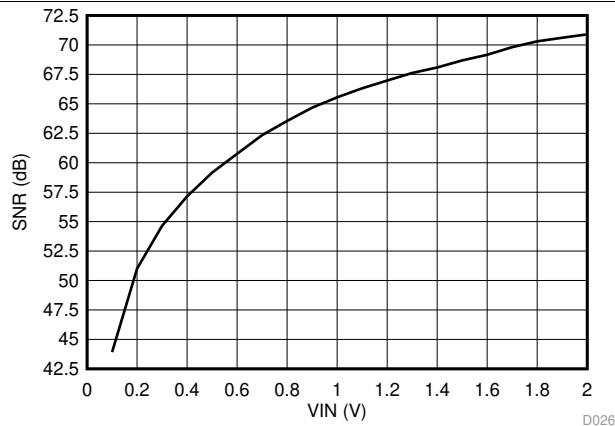
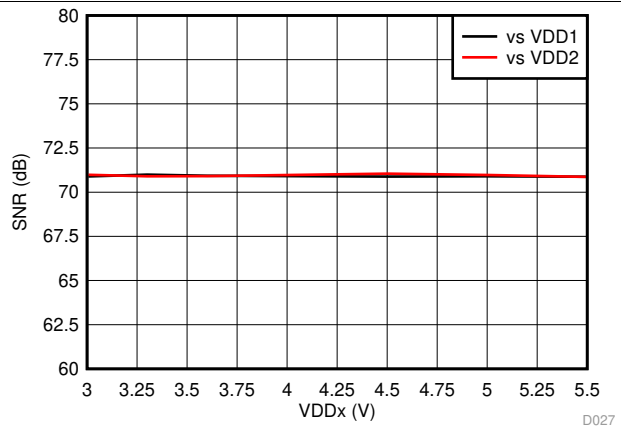
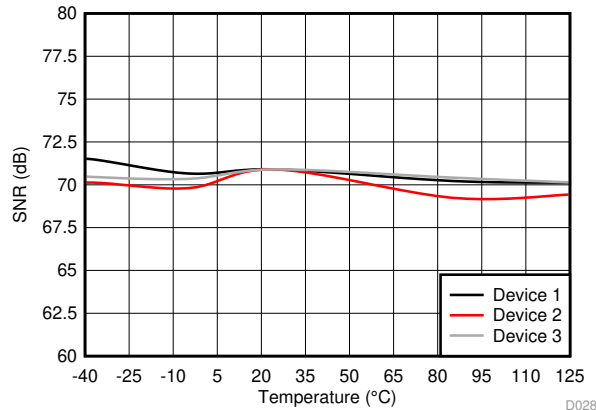

Figure 29. Signal-to-Noise Ratio vs Input Voltage



3.0 V ≤ VDD1 < 4.5 V for the AMC1311B only

Figure 30. Signal-to-Noise Ratio vs Supply Voltage



-55°C ≤ T<sub>A</sub> < -40°C for the AMC1311B only

Figure 31. Signal-to-Noise Ratio vs Temperature

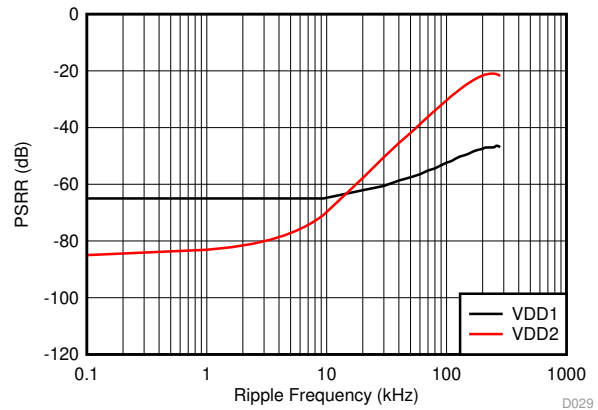

100-mV ripple

Figure 32. Power-Supply Rejection Ratio vs Ripple Frequency

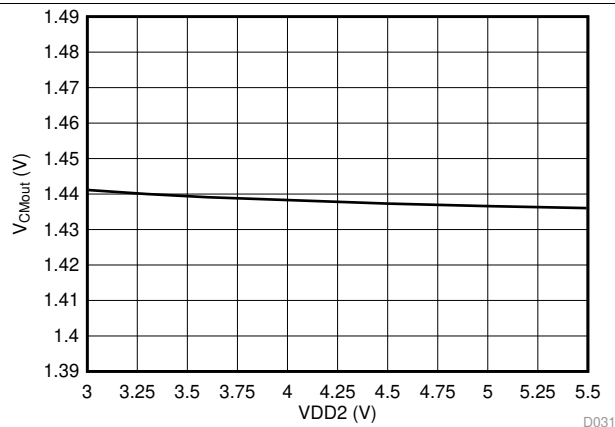
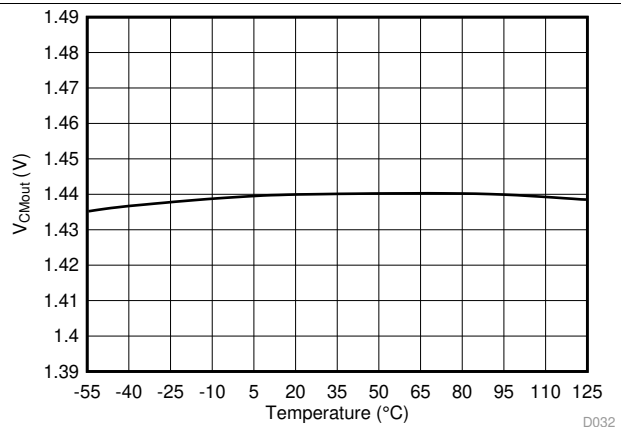

Figure 33. Output Common-Mode Voltage vs Low-Side Supply Voltage



-55°C ≤ T<sub>A</sub> < -40°C for the AMC1311B only

Figure 34. Output Common-Mode Voltage vs Temperature



Typical Characteristics (continued)

at VDD1 = 5 V, VDD2 = 3.3 V, SHTDN = 0 V,  $f_{IN} = 10$  kHz, and BW = 100 kHz (unless otherwise noted)

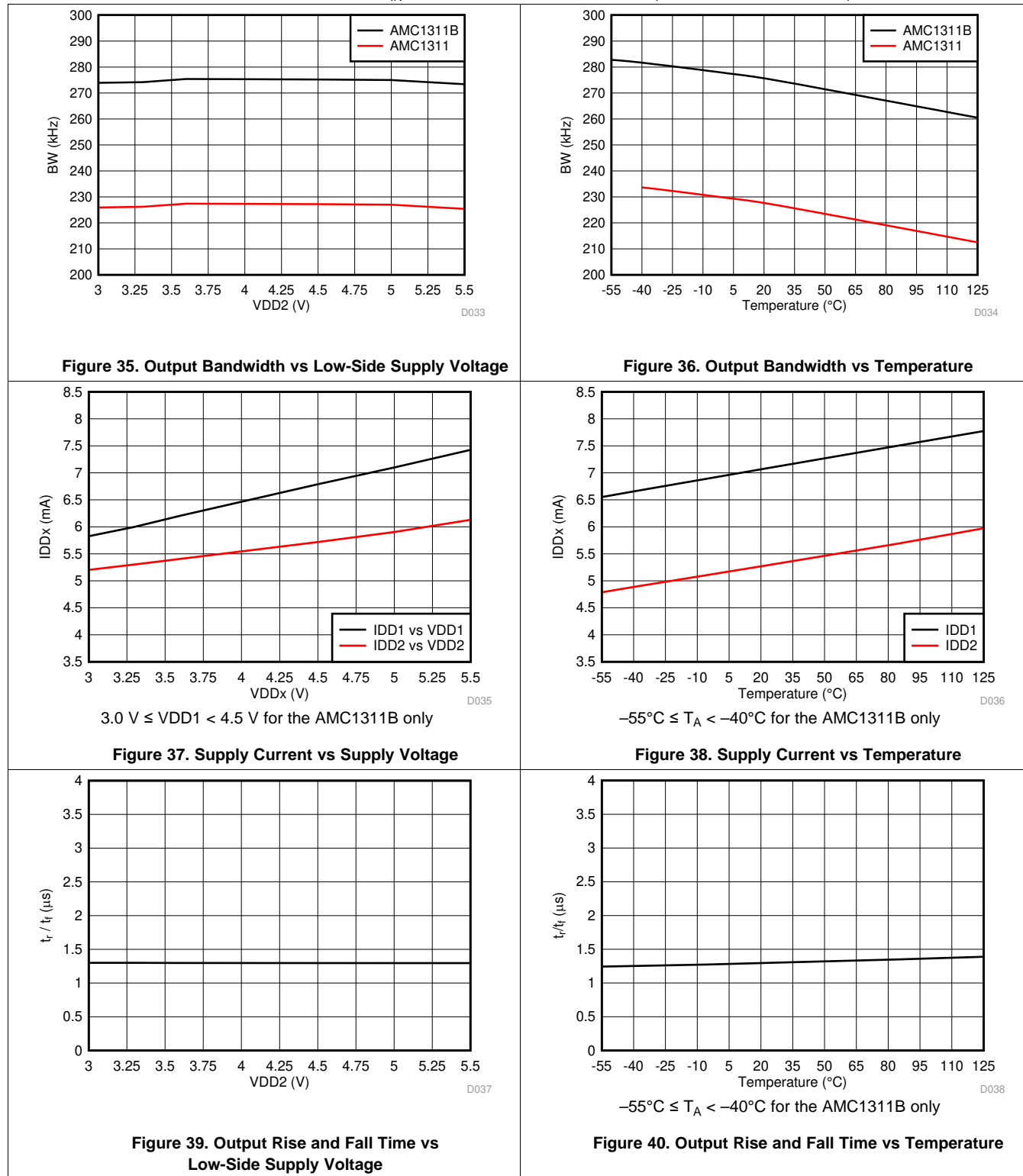

Typical Characteristics (continued)

at VDD1 = 5 V, VDD2 = 3.3 V, SHTDN = 0 V,  $f_{IN} = 10$  kHz, and BW = 100 kHz (unless otherwise noted)

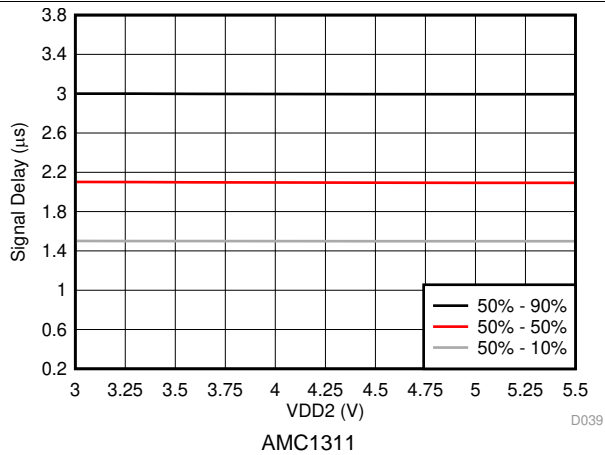

Figure 41. VIN to VOUTP, VOUTN Signal Delay vs Low-Side Supply Voltage

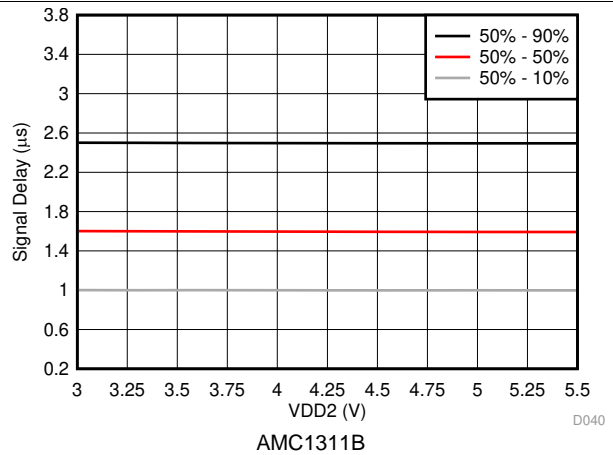

Figure 42. VIN to VOUTP, VOUTN Signal Delay vs Low-Side Supply Voltage

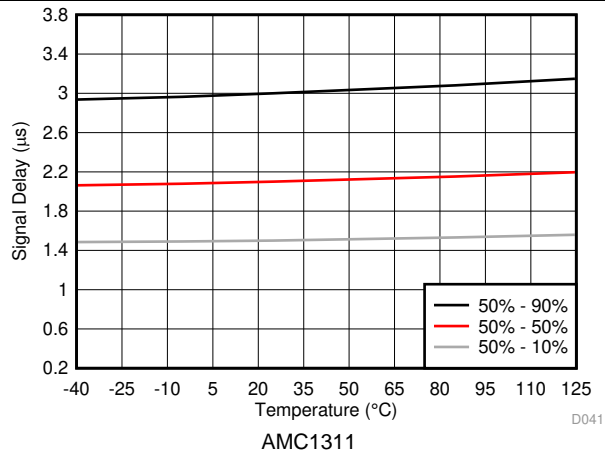

Figure 43. VIN to VOUTP, VOUTN Signal Delay vs Temperature

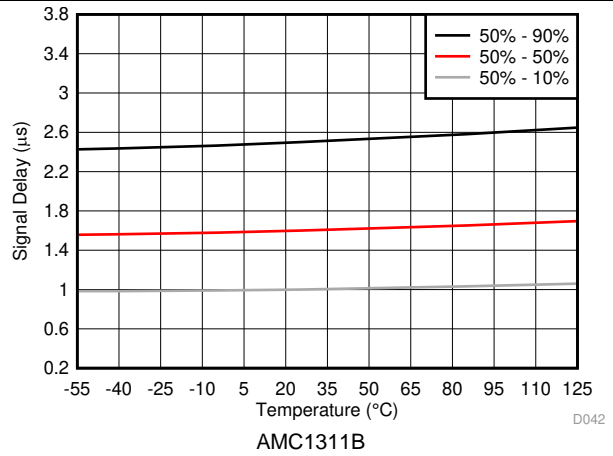

Figure 44. VIN to VOUTP, VOUTN Signal Delay vs Temperature

## 8 Detailed Description

### 8.1 Overview

The AMC1311 is a precision, isolated amplifier with a high input-impedance and wide input-voltage range. The input stage of the device drives a second-order, delta-sigma ( $\Delta\Sigma$ ) modulator. The modulator uses the internal voltage reference and clock generator to convert the analog input signal to a digital bitstream. The drivers (termed TX in the *Functional Block Diagram* section) transfer the output of the modulator across the isolation barrier that separates the high-side and low-side voltage domains. The received bitstream and clock are synchronized and processed by a fourth-order analog filter on the low-side and presented as a differential analog output.

The SiO<sub>2</sub>-based, double-capacitive isolation barrier supports a high level of magnetic field immunity, as described in *ISO72x Digital Isolator Magnetic-Field Immunity*. The digital modulation used in the AMC1311 and the isolation barrier characteristics result in high reliability and common-mode transient immunity.

### 8.2 Functional Block Diagram

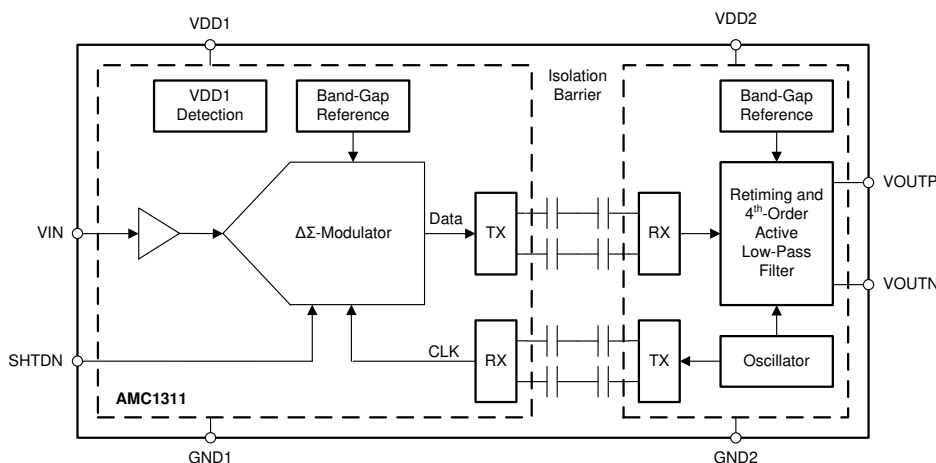

### 8.3 Feature Description

#### 8.3.1 Analog Input

The input stage of the AMC1311 feeds a second-order, switched-capacitor, feed-forward  $\Delta\Sigma$  modulator. The modulator converts the analog signal into a bitstream that is transferred over the isolation barrier, as described in the *Isolation Channel Signal Transmission* section. The high-impedance, and low bias-current input of the AMC1311 makes the device suitable for isolated voltage sensing applications. Figure 45 depicts the equivalent input structure of the AMC1311 with the relevant components.

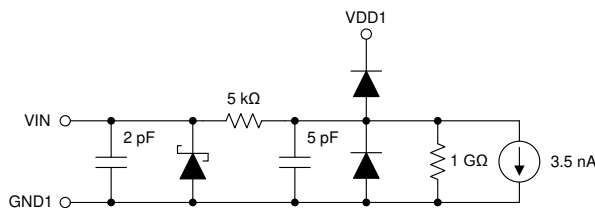

Figure 45. Equivalent Analog Input Circuit

There are two restrictions on the analog input signal, VIN. First, if the input voltage VIN exceeds the voltage of 6.5 V, the input current must be limited to 10 mA because the device input electrostatic discharge (ESD) protection turns on. In addition, the linearity and noise performance of the device are ensured only when the analog input voltage remains within the specified linear full-scale range (V<sub>FSR</sub>).

**Feature Description (continued)**

**8.3.2 Isolation Channel Signal Transmission**

The AMC1311 uses an on-off keying (OOK) modulation scheme to transmit the modulator output bitstream across the SiO<sub>2</sub>-based isolation barrier. As shown in Figure 46, the transmitter modulates the bitstream at TX IN with an internally-generated, high-frequency carrier across the isolation barrier to represent a digital *one* and does not send a signal to represent the digital *zero*. The nominal frequency of the carrier used inside the AMC1311 is 480 MHz.

The receiver demodulates the signal after advanced signal conditioning and produces the output. The AMC1311 also incorporates advanced circuit techniques to maximize the CMTI performance and minimize the radiated emissions caused by the high-frequency carrier and IO buffer switching.

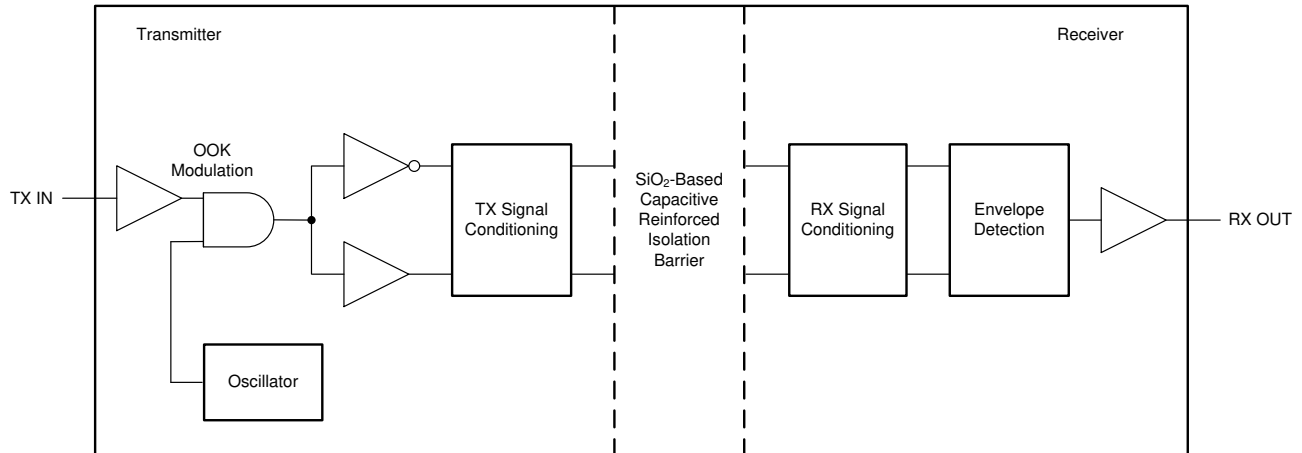

**Figure 46. Block Diagram of an Isolation Channel**

Figure 47 shows the concept of the OOK scheme.

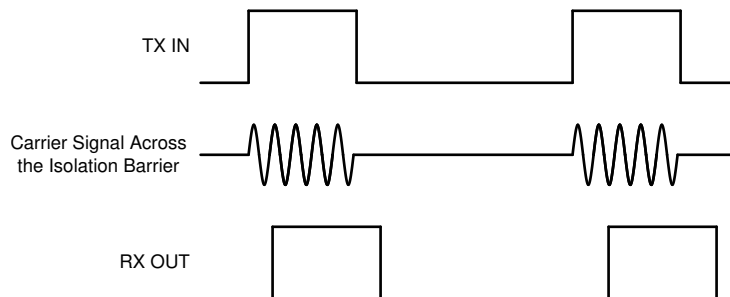

**Figure 47. OOK-Based Modulation Scheme**

## Feature Description (continued)

### 8.3.3 Fail-Safe Output

The AMC1311 offers a fail-safe output that simplifies diagnostics on system level. The fail-safe output is active in three cases:

- When the high-side supply VDD1 of the AMC1311 device is missing
- When the high-side supply VDD1 falls under the  $V_{DD1_{UV}}$  undervoltage threshold level or
- When the SHTDN pin is pulled high

Figure 48 shows the fail-safe output of the AMC1311 that is a negative differential output voltage that does not occur under normal device operation. As a reference value for the fail-safe detection on a system level, use the  $V_{FAILSAFE}$  voltage as specified in the [Electrical Characteristics](#) table.

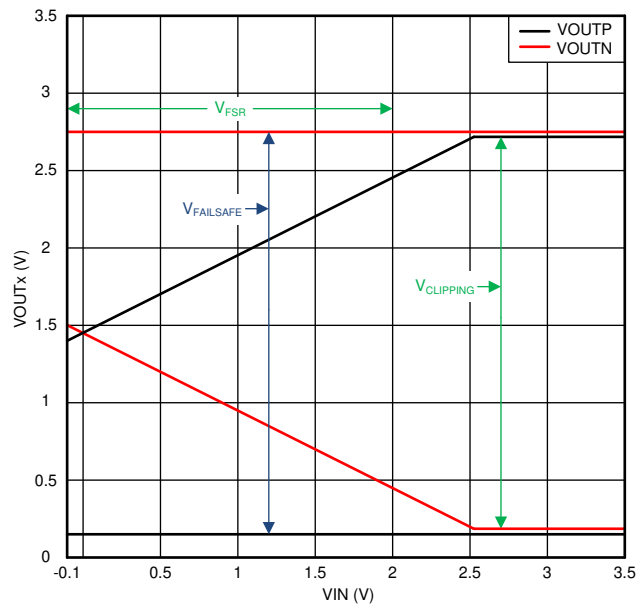

Figure 48. AMC1311 Output Behavior

### 8.4 Device Functional Modes

The AMC1311 is operational when the power supplies VDD1 and VDD2 are applied, as specified in the [Recommended Operating Conditions](#) table.

## 9 Application and Implementation

### NOTE

Information in the following applications sections is not part of the TI component specification, and TI does not warrant its accuracy or completeness. TI's customers are responsible for determining suitability of components for their purposes. Customers should validate and test their design implementation to confirm system functionality.

### 9.1 Application Information

The very low input bias current, ac and dc errors, and temperature drift make the AMC1311 a high-performance solution for industrial applications where voltage measurement with high common-mode levels is required.

### 9.2 Typical Application

Isolated amplifiers are widely used in frequency inverters that are critical parts of industrial motor drives, photovoltaic inverters, uninterruptible power supplies, and other industrial applications. The input structure of the AMC1311 is tailored for isolated voltage sensing using resistive dividers to reduce the high common-mode voltage.

Figure 49 depicts a typical use of the AMC1311 for dc bus voltage sensing in a frequency inverter application. Phase current measurement is accomplished through the shunt resistors,  $R_{SHUNT}$  (in this case, two-pin shunts) and the AMC1301 isolated amplifiers that are optimized for isolated current sensing. The high-impedance input and the high common-mode transient immunity of the AMC1311 ensure reliable and accurate operation even in high-noise environments, such as the power stage of frequency inverters as used in motor drives.

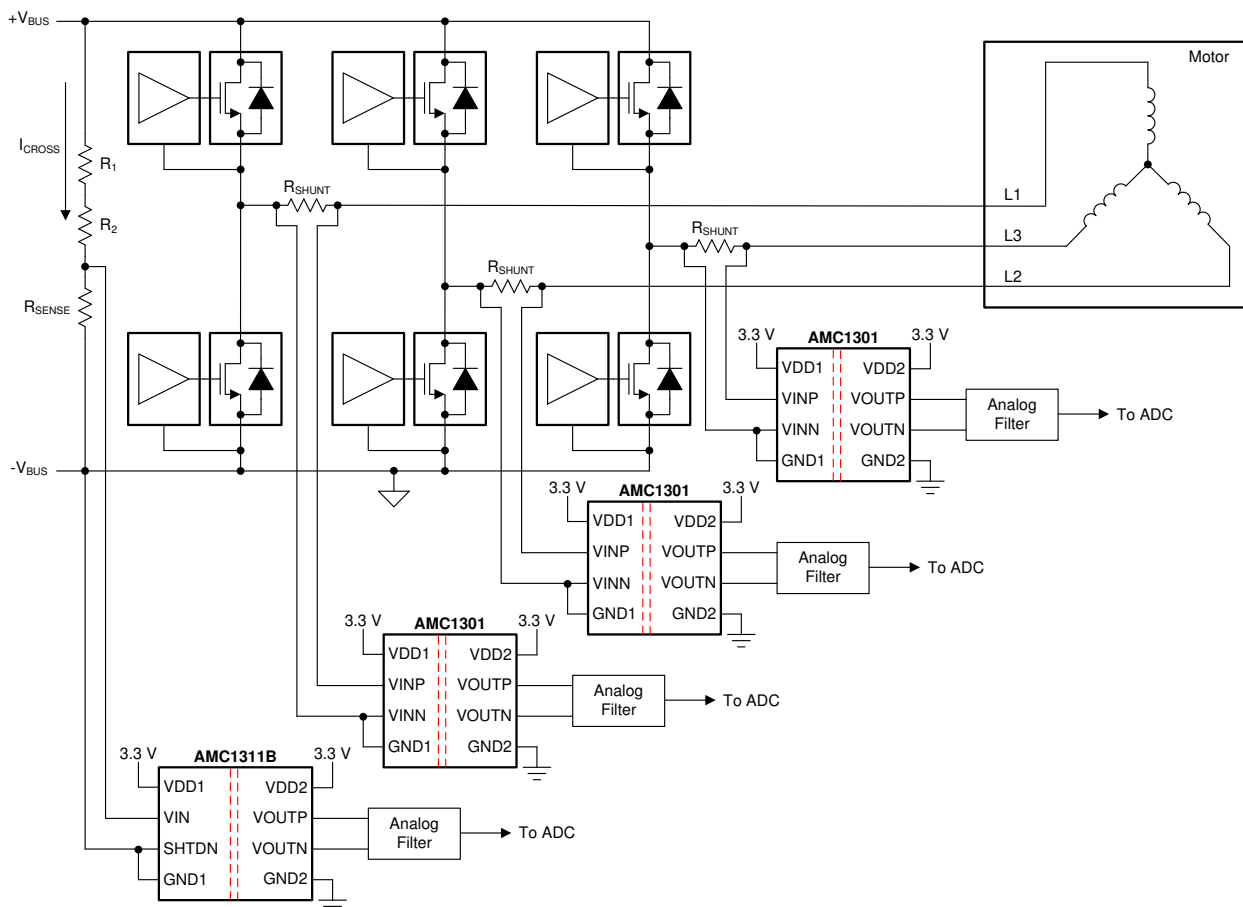

Figure 49. Using the AMC1311B for DC Bus Voltage Sensing in Frequency Inverters

## Typical Application (continued)

### 9.2.1 Design Requirements

Table 1 lists the parameters for this typical application.

**Table 1. Design Requirements**

PARAMETER	VALUE
High-side supply voltage	3.3 V or 5 V
Low-side supply voltage	3.3 V or 5 V
Voltage drop across the sensing resistor for a linear response	2 V (maximum)
Current through the resistive divider, $I_{CROSS}$	0.1 mA (maximum)
Signal delay (50% $V_{IN}$ to 90% $V_{OUTP}$ , $V_{OUTN}$ )	3 $\mu$ s (maximum)

### 9.2.2 Detailed Design Procedure

Use Ohm's Law to calculate the minimum total resistance of the resistive divider to limit the cross current to the desired value ( $R_{TOTAL} = V_{BUS} / I_{CROSS}$ ) and the required sense resistor value to be connected to the AMC1311 input:  $R_{SENSE} = V_{FSR} / I_{CROSS}$ .

Consider the following two restrictions to choose the proper value of the shunt resistor  $R_{SENSE}$ :

- The voltage drop on  $R_{SENSE}$  caused by the nominal voltage range of the system must not exceed the recommended input voltage range:  $V_{SENSE} \leq V_{FSR}$
- The voltage drop on  $R_{SENSE}$  caused by the maximum allowed system overvoltage must not exceed the input voltage that causes a clipping output:  $V_{SENSE} \leq V_{Clipping}$

Table 2 lists examples of nominal E96-series (1% accuracy) resistor values for systems using 600 V and 800 V on the dc bus.

**Table 2. Resistor Value Examples**

PARAMETER	600-V DC BUS	800-V DC Bus
Resistive divider resistor $R_1$	3.01 M $\Omega$	4.22 M $\Omega$
Resistive divider resistor $R_2$	3.01 M $\Omega$	4.22 M $\Omega$
Sense resistor $R_{SENSE}$	20 k $\Omega$	21 k $\Omega$
Resulting current through resistive divider $I_{CROSS}$	99.3 $\mu$ A	94.5 $\mu$ A
Resulting voltage drop on sense resistor $V_{SENSE}$	1.987 V	1.986 V

For systems using single-ended input ADCs, Figure 50 shows an example of a TLV6001-based signal conversion and filter circuit as used on the AMC1311EVM. Tailor the bandwidth of this filter stage to the bandwidth requirement of the system and use NP0-type capacitors for best performance.

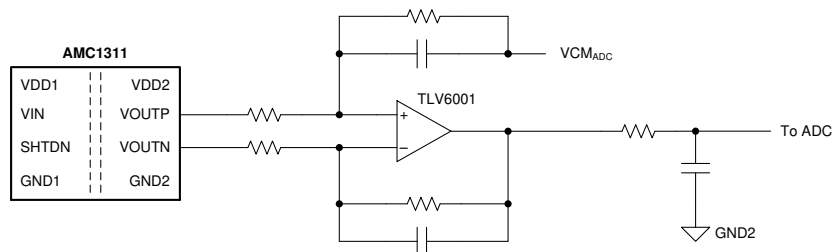
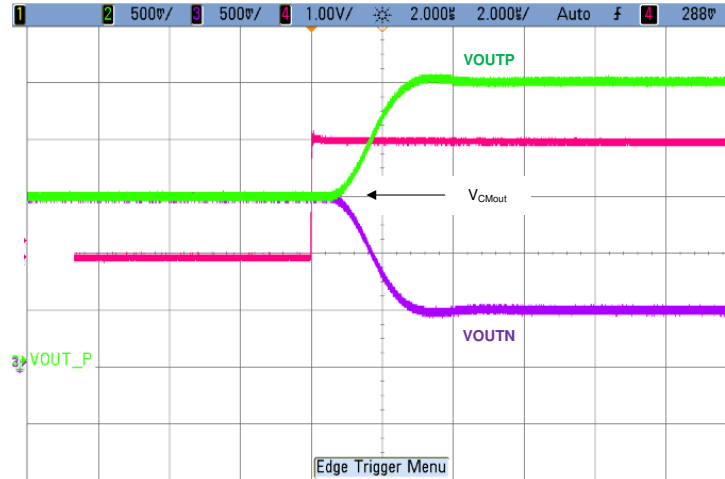

**Figure 50. Connecting the AMC1311 Output to Single-Ended Input ADC**

For more information on the general procedure to design the filtering and driving stages of SAR ADCs, see *18-Bit, 1MSPS Data Acquisition Block (DAQ) Optimized for Lowest Distortion and Noise* and *18-Bit Data Acquisition Block (DAQ) Optimized for Lowest Power*, available for download at [www.ti.com](http://www.ti.com).

### 9.2.3 Application Curve

In frequency inverter applications, the power switches must be protected in case of an overvoltage condition. To allow for fast system power-off, a low delay caused by the isolated amplifier is required. Figure 51 shows the typical full-scale step response of the AMC1311. Consider the delay of the required window comparator and the MCU to calculate the overall response time of the system.



**Figure 51. Step Response of the AMC1311B**

### 9.3 What To Do and What Not To Do

Do not leave the analog input VIN of the AMC1311 unconnected (floating) when the device is powered up on the high-side. If the device input is left floating, the bias current may generate a negative input voltage that exceeds the specified input voltage range and the output of the device is invalid.



## 10 Power Supply Recommendations

In a typical frequency inverter application, the high-side power supply (VDD1) for the AMC1311 is generated from the low-side supply (VDD2) of the device by an isolated dc/dc converter circuit. A low-cost solution is based on the push-pull driver [SN6501](#) and a transformer that supports the desired isolation voltage ratings. TI recommends using a low-ESR decoupling capacitor of 0.1  $\mu\text{F}$  and an additional capacitor of minimum 1  $\mu\text{F}$  for both supplies of the AMC1311. Place these decoupling capacitors as close as possible to the AMC1311 power-supply pins to minimize supply current loops and electromagnetic emissions.

The AMC1311 does not require any specific power up sequencing. Consider the analog settling time  $t_{AS}$  as specified in the [Switching Characteristics](#) table after ramp up of the VDD1 high-side supply.

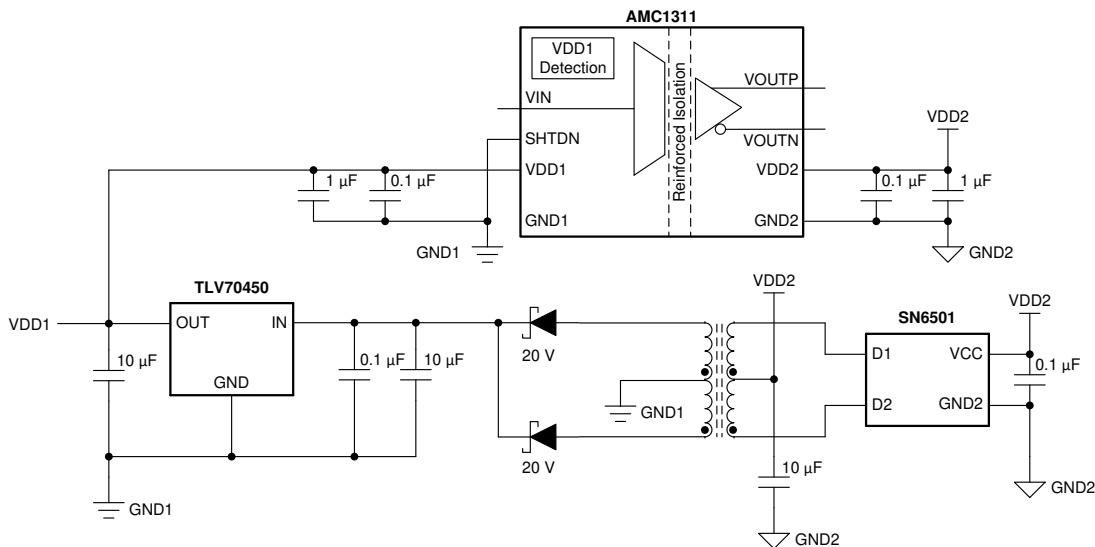

Figure 52. SN6501-Based, High-Side Power Supply

## 11 Layout

### 11.1 Layout Guidelines

For best performance, place the smaller 0.1- $\mu$ F decoupling capacitors (C1 and C6) as close as possible to the AMC1311 power-supply pins, followed by the additional C2 and C5 capacitors with a minimum value of 1  $\mu$ F. The resistors and capacitors used for the analog input (C3) and output filters (R5, R10, and C13) are placed next to the decoupling capacitors. Use 1206-size, SMD-type, ceramic decoupling capacitors and route the traces to the VIN and SHTDN pins underneath. Connect the supply voltage sources in a way that allows the supply current to flow through the pads of the decoupling capacitors before powering the AMC1311.

Figure 53 shows this approach as implemented on the AMC1311EVM. Capacitors C5 and C6 decouple the high-side supply VDD1 while capacitors C1 and C2 are used to support the low-side supply VDD2 of the AMC1311.

### 11.2 Layout Example

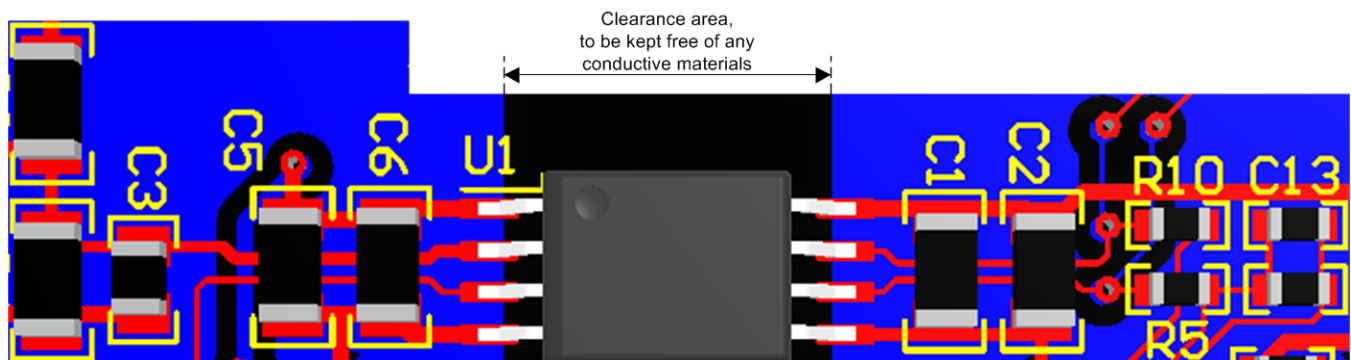

Figure 53. Recommended Layout of the AMC1311

## 12 Device and Documentation Support

### 12.1 Device Support

#### 12.1.1 Device Nomenclature

Texas Instruments, [Isolation Glossary](#)

### 12.2 Documentation Support

#### 12.2.1 Receiving Notification of Documentation Updates

To receive notification of documentation updates, navigate to the device product folder on ti.com. In the upper right corner, click on *Alert me* to register and receive a weekly digest of any product information that has changed. For change details, review the revision history included in any revised document.

#### 12.2.2 Related Documentation

For related documentation, see the following:

- Texas Instruments, [Dual, 1MSPS, 16-/14-/12-Bit, 4x2 or 2x2 Channel, Simultaneous Sampling Analog-to-Digital Converter data sheet](#)
- Texas Instruments, [Semiconductor and IC Package Thermal Metrics](#) application report
- Texas Instruments, [ISO72x Digital Isolator Magnetic-Field Immunity](#) application report
- Texas Instruments, [AMC1301 Precision, ±250-mV Input, 3-μs Delay, Reinforced Isolated Amplifier data sheet](#)
- Texas Instruments, [TLV600x Low-Power, Rail-to-Rail In/Out, 1-MHz Operational Amplifier for Cost-Sensitive Systems data sheet](#)
- Texas Instruments, [AMC1311EVM Users Guide](#)
- Texas Instruments, [18-Bit, 1-MSPS Data Acquisition Block \(DAQ\) Optimized for Lowest Distortion and Noise reference guide](#)
- Texas Instruments, [18-Bit, 1-MSPS Data Acquisition Block \(DAQ\) Optimized for Lowest Power reference guide](#)
- Texas Instruments, [SN6501 Transformer Driver for Isolated Power Supplies data sheet](#)

#### 12.3 Receiving Notification of Documentation Updates

To receive notification of documentation updates, navigate to the device product folder on ti.com. In the upper right corner, click on *Alert me* to register and receive a weekly digest of any product information that has changed. For change details, review the revision history included in any revised document.

### 12.4 Support Resources

[TI E2E™ support forums](#) are an engineer's go-to source for fast, verified answers and design help — straight from the experts. Search existing answers or ask your own question to get the quick design help you need.

Linked content is provided "AS IS" by the respective contributors. They do not constitute TI specifications and do not necessarily reflect TI's views; see TI's [Terms of Use](#).

### 12.5 Trademarks

E2E is a trademark of Texas Instruments.

All other trademarks are the property of their respective owners.

### 12.6 Electrostatic Discharge Caution



This integrated circuit can be damaged by ESD. Texas Instruments recommends that all integrated circuits be handled with appropriate precautions. Failure to observe proper handling and installation procedures can cause damage.

ESD damage can range from subtle performance degradation to complete device failure. Precision integrated circuits may be more susceptible to damage because very small parametric changes could cause the device not to meet its published specifications.

## 12.7 Glossary

[SLYZ022](#) — *TI Glossary*.

This glossary lists and explains terms, acronyms, and definitions.

## 13 Mechanical, Packaging, and Orderable Information

The following pages include mechanical, packaging, and orderable information. This information is the most current data available for the designated devices. This data is subject to change without notice and revision of this document. For browser-based versions of this data sheet, refer to the left-hand navigation.

**PACKAGING INFORMATION**

Orderable Device	Status (1)	Package Type	Package Drawing	Pins	Package Qty	Eco Plan (2)	Lead finish/ Ball material (6)	MSL Peak Temp (3)	Op Temp (°C)	Device Marking (4/5)	Samples
AMC1311BDWV	ACTIVE	SOIC	DWV	8	64	RoHS & Green	NIPDAU	Level-3-260C-168 HR	-55 to 125	1311B	<a href="#">Samples</a>
AMC1311BDWVR	ACTIVE	SOIC	DWV	8	1000	RoHS & Green	NIPDAU	Level-3-260C-168 HR	-55 to 125	1311B	<a href="#">Samples</a>
AMC1311DWV	ACTIVE	SOIC	DWV	8	64	RoHS & Green	NIPDAU	Level-3-260C-168 HR	-40 to 125	1311	<a href="#">Samples</a>
AMC1311DWVR	ACTIVE	SOIC	DWV	8	1000	RoHS & Green	NIPDAU	Level-3-260C-168 HR	-40 to 125	1311	<a href="#">Samples</a>

(1) The marketing status values are defined as follows:

**ACTIVE:** Product device recommended for new designs.

**LIFEBUY:** TI has announced that the device will be discontinued, and a lifetime-buy period is in effect.

**NRND:** Not recommended for new designs. Device is in production to support existing customers, but TI does not recommend using this part in a new design.

**PREVIEW:** Device has been announced but is not in production. Samples may or may not be available.

**OBSOLETE:** TI has discontinued the production of the device.

(2) **RoHS:** TI defines "RoHS" to mean semiconductor products that are compliant with the current EU RoHS requirements for all 10 RoHS substances, including the requirement that RoHS substance do not exceed 0.1% by weight in homogeneous materials. Where designed to be soldered at high temperatures, "RoHS" products are suitable for use in specified lead-free processes. TI may reference these types of products as "Pb-Free".

**RoHS Exempt:** TI defines "RoHS Exempt" to mean products that contain lead but are compliant with EU RoHS pursuant to a specific EU RoHS exemption.

**Green:** TI defines "Green" to mean the content of Chlorine (Cl) and Bromine (Br) based flame retardants meet JS709B low halogen requirements of <=1000ppm threshold. Antimony trioxide based flame retardants must also meet the <=1000ppm threshold requirement.

(3) **MSL, Peak Temp.** - The Moisture Sensitivity Level rating according to the JEDEC industry standard classifications, and peak solder temperature.

(4) There may be additional marking, which relates to the logo, the lot trace code information, or the environmental category on the device.

(5) Multiple Device Markings will be inside parentheses. Only one Device Marking contained in parentheses and separated by a "-" will appear on a device. If a line is indented then it is a continuation of the previous line and the two combined represent the entire Device Marking for that device.

(6) **Lead finish/Ball material** - Orderable Devices may have multiple material finish options. Finish options are separated by a vertical ruled line. Lead finish/Ball material values may wrap to two lines if the finish value exceeds the maximum column width.

**Important Information and Disclaimer:**The information provided on this page represents TI's knowledge and belief as of the date that it is provided. TI bases its knowledge and belief on information provided by third parties, and makes no representation or warranty as to the accuracy of such information. Efforts are underway to better integrate information from third parties. TI has taken and

continues to take reasonable steps to provide representative and accurate information but may not have conducted destructive testing or chemical analysis on incoming materials and chemicals. TI and TI suppliers consider certain information to be proprietary, and thus CAS numbers and other limited information may not be available for release.

In no event shall TI's liability arising out of such information exceed the total purchase price of the TI part(s) at issue in this document sold by TI to Customer on an annual basis.

**OTHER QUALIFIED VERSIONS OF AMC1311 :**

- Automotive: [AMC1311-Q1](#)

**NOTE: Qualified Version Definitions:**

- Automotive - Q100 devices qualified for high-reliability automotive applications targeting zero defects

**TAPE AND REEL INFORMATION**

**QUADRANT ASSIGNMENTS FOR PIN 1 ORIENTATION IN TAPE**

\*All dimensions are nominal

Device	Package Type	Package Drawing	Pins	SPQ	Reel Diameter (mm)	Reel Width W1 (mm)	A0 (mm)	B0 (mm)	K0 (mm)	P1 (mm)	W (mm)	Pin1 Quadrant
AMC1311BDWVR	SOIC	DWV	8	1000	330.0	16.4	12.05	6.15	3.3	16.0	16.0	Q1
AMC1311DWVR	SOIC	DWV	8	1000	330.0	16.4	12.05	6.15	3.3	16.0	16.0	Q1

**TAPE AND REEL BOX DIMENSIONS**

\*All dimensions are nominal

Device	Package Type	Package Drawing	Pins	SPQ	Length (mm)	Width (mm)	Height (mm)
AMC1311BDWVR	SOIC	DWV	8	1000	350.0	350.0	43.0
AMC1311DWVR	SOIC	DWV	8	1000	350.0	350.0	43.0



**TUBE**

\*All dimensions are nominal

Device	Package Name	Package Type	Pins	SPQ	L (mm)	W (mm)	T (μm)	B (mm)
AMC1311BDWV	DWV	SOIC	8	64	505.46	13.94	4826	6.6
AMC1311DWV	DWV	SOIC	8	64	505.46	13.94	4826	6.6

# PACKAGE OUTLINE

DWV0008A



SOIC - 2.8 mm max height

SOIC

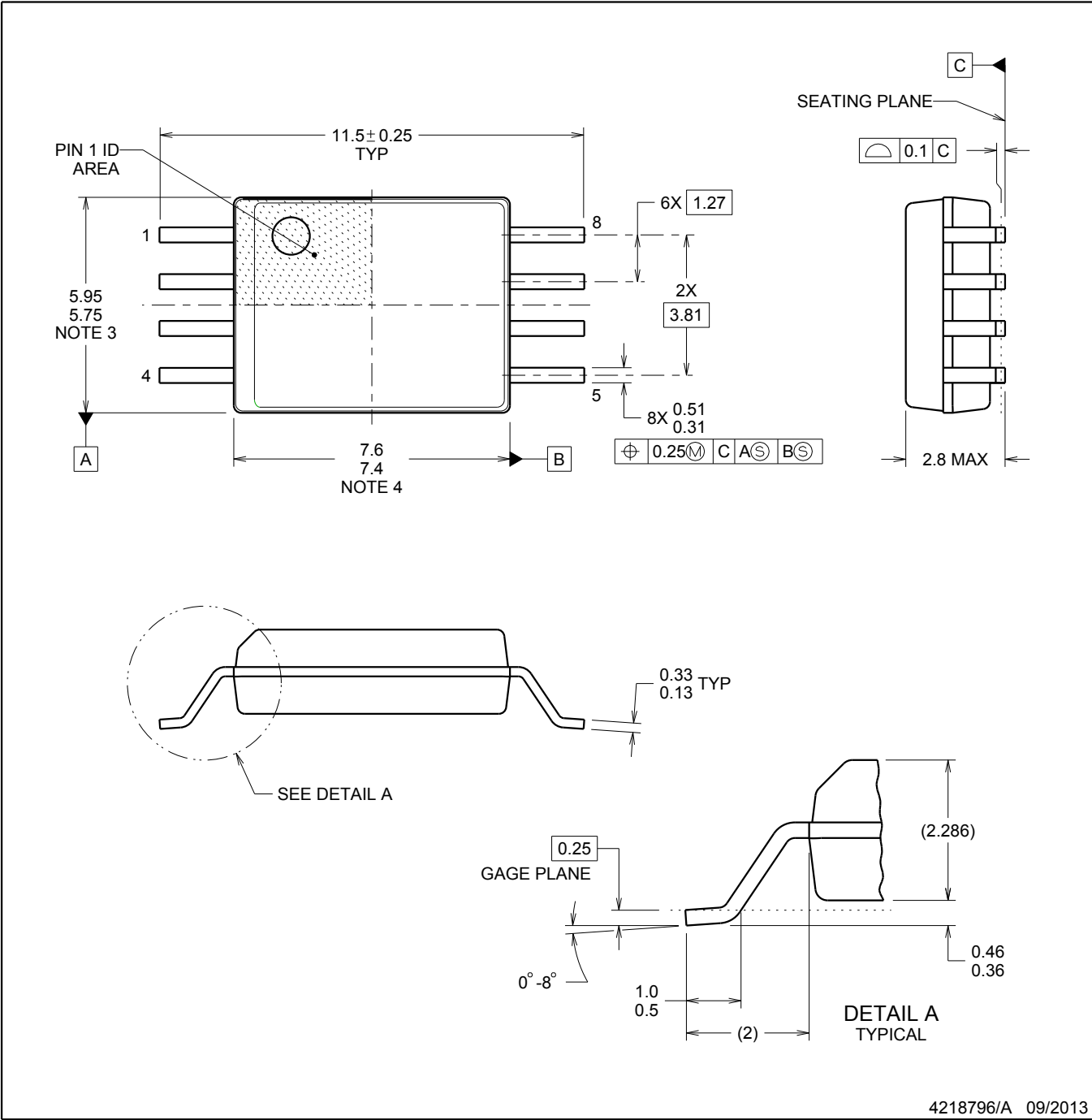

**NOTES:**

1. All linear dimensions are in millimeters. Dimensions in parenthesis are for reference only. Dimensioning and tolerancing per ASME Y14.5M.
2. This drawing is subject to change without notice.
3. This dimension does not include mold flash, protrusions, or gate burrs. Mold flash, protrusions, or gate burrs shall not exceed 0.15 mm, per side.
4. This dimension does not include interlead flash. Interlead flash shall not exceed 0.25 mm, per side.



LAND PATTERN EXAMPLE  
 9.1 mm NOMINAL CLEARANCE/CREEPAGE  
 SCALE:6X

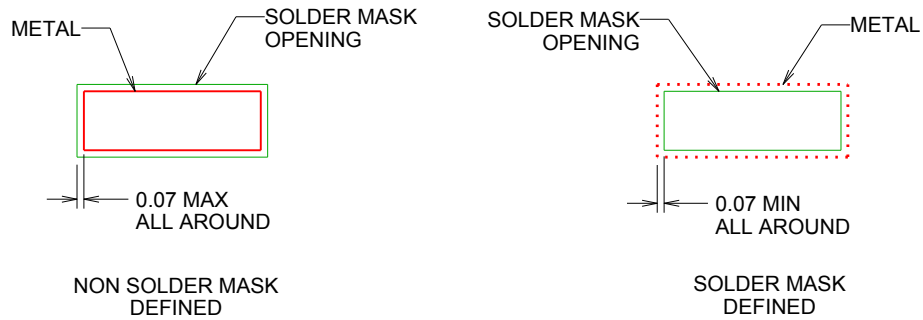

SOLDER MASK DETAILS

4218796/A 09/2013

NOTES: (continued)

- 5. Publication IPC-7351 may have alternate designs.
- 6. Solder mask tolerances between and around signal pads can vary based on board fabrication site.

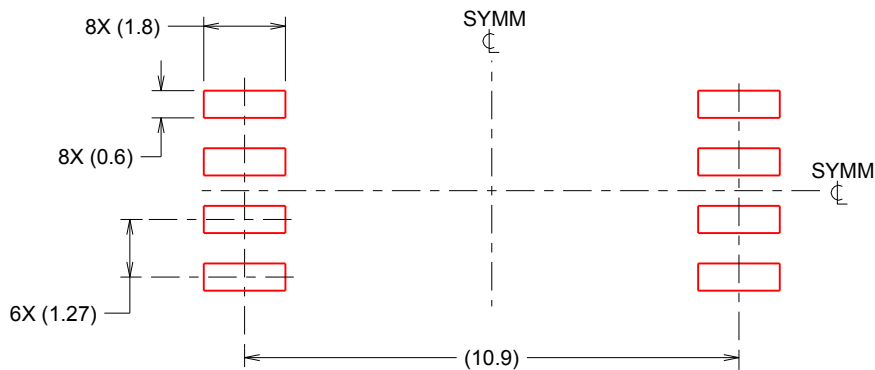

SOLDER PASTE EXAMPLE  
 BASED ON 0.125 mm THICK STENCIL  
 SCALE:6X

4218796/A 09/2013

NOTES: (continued)

- 7. Laser cutting apertures with trapezoidal walls and rounded corners may offer better paste release. IPC-7525 may have alternate design recommendations.
- 8. Board assembly site may have different recommendations for stencil design.

## IMPORTANT NOTICE AND DISCLAIMER

TI PROVIDES TECHNICAL AND RELIABILITY DATA (INCLUDING DATA SHEETS), DESIGN RESOURCES (INCLUDING REFERENCE DESIGNS), APPLICATION OR OTHER DESIGN ADVICE, WEB TOOLS, SAFETY INFORMATION, AND OTHER RESOURCES "AS IS" AND WITH ALL FAULTS, AND DISCLAIMS ALL WARRANTIES, EXPRESS AND IMPLIED, INCLUDING WITHOUT LIMITATION ANY IMPLIED WARRANTIES OF MERCHANTABILITY, FITNESS FOR A PARTICULAR PURPOSE OR NON-INFRINGEMENT OF THIRD PARTY INTELLECTUAL PROPERTY RIGHTS.

These resources are intended for skilled developers designing with TI products. You are solely responsible for (1) selecting the appropriate TI products for your application, (2) designing, validating and testing your application, and (3) ensuring your application meets applicable standards, and any other safety, security, regulatory or other requirements.

These resources are subject to change without notice. TI grants you permission to use these resources only for development of an application that uses the TI products described in the resource. Other reproduction and display of these resources is prohibited. No license is granted to any other TI intellectual property right or to any third party intellectual property right. TI disclaims responsibility for, and you will fully indemnify TI and its representatives against, any claims, damages, costs, losses, and liabilities arising out of your use of these resources.

TI's products are provided subject to [TI's Terms of Sale](#) or other applicable terms available either on [ti.com](http://ti.com) or provided in conjunction with such TI products. TI's provision of these resources does not expand or otherwise alter TI's applicable warranties or warranty disclaimers for TI products.

TI objects to and rejects any additional or different terms you may have proposed.

Mailing Address: Texas Instruments, Post Office Box 655303, Dallas, Texas 75265  
Copyright © 2022, Texas Instruments Incorporated