

SE80130G

**N-Channel Enhancement-Mode MOSFET**

Revision: A

**General Description**

Advanced trench technology to provide excellent RDS(ON), low gate charge and low operation voltage. This device is suitable for using as a load switch or in PWM applications.

- Simple Drive Requirement
- Small Package Outline
- Surface Mount Device

**Features**

For a single MOSFET

- $V_{DS} = 80V$
- $R_{DS(ON)} = 3.6m\Omega @ V_{GS}=10V$

**Pin configurations**

See Diagram below

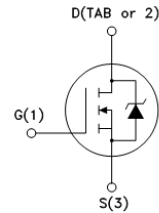
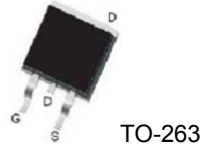
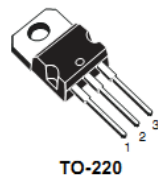

**Absolute Maximum Ratings**

Parameter		Symbol	Rating	Units
Drain-Source Voltage		$V_{DS}$	80	V
Gate-Source Voltage		$V_{GS}$	$\pm 20$	V
Drain Current	Continuous	$I_D$	130	A
	Pulsed		320	
Single Pulse Avalanche Energy		$E_{AS}$	784	mJ
Total Power Dissipation	@TC=25°C	$P_D$	160	W
Operating Junction Temperature Range		$T_J$	-55 to 175	°C

## SE80130G

Electrical Characteristics (T <sub>J</sub> =25°C unless otherwise noted)						
Symbol	Parameter	Test Conditions	Min	Typ	Max	Units
<b>OFF CHARACTERISTICS (Note 2)</b>						
B <sub>V</sub> DSS	Drain-Source Breakdown Voltage	I <sub>D</sub> =250μA, V <sub>GS</sub> =0 V	80			V
I <sub>DSS</sub>	Drain to Source Leakage Current	V <sub>DS</sub> =85V, V <sub>GS</sub> =0V			1	μA
I <sub>GSS</sub>	Gate-Body Leakage Current	V <sub>GS</sub> =20V			100	nA
V <sub>GS(th)</sub>	Gate Threshold Voltage	V <sub>DS</sub> = V <sub>GS</sub> , I <sub>D</sub> =250μA	2.5		4.5	V
R <sub>DS(ON)</sub>	Static Drain-Source On-Resistance	V <sub>GS</sub> =10V, I <sub>D</sub> =60A	-	3.6	4.3	mΩ
g <sub>FS</sub>	Forward Transconductance	V <sub>DS</sub> =10V, I <sub>D</sub> =60A	40			S
<b>DYNAMIC PARAMETERS</b>						
C <sub>iss</sub>	Input Capacitance	V <sub>GS</sub> =0V, V <sub>DS</sub> =40V, f=1MHz		5500		pF
C <sub>oss</sub>	Output Capacitance			830		pF
C <sub>rss</sub>	Reverse Transfer Capacitance			57		pF
<b>SWITCHING PARAMETERS</b>						
Q <sub>g</sub>	Total Gate Charge <sup>2</sup>	V <sub>GS</sub> =10V, V <sub>DS</sub> =40V, I <sub>D</sub> =60A		55		nC
Q <sub>gs</sub>	Gate Source Charge			21		nC
Q <sub>gd</sub>	Gate Drain Charge			9		nC
t <sub>d(on)</sub>	Turn-On Delay Time	V <sub>GS</sub> =10V, V <sub>DS</sub> =40V, R <sub>GEN</sub> =4.7Ω I <sub>D</sub> =60A		13.5		ns
t <sub>d(off)</sub>	Turn-Off Delay Time			38		ns
t <sub>d(r)</sub>	Turn-On Rise Time			12.5		ns
t <sub>d(f)</sub>	Turn-Off Fall Time			13.5		ns
<b>Thermal Resistance</b>						
Symbol	Parameter		Typ	Max	Units	
R <sub>θJC</sub>	Thermal Resistance Junction to Case(t≤10s)		-	0.42	°C/W	

Typical Characteristics

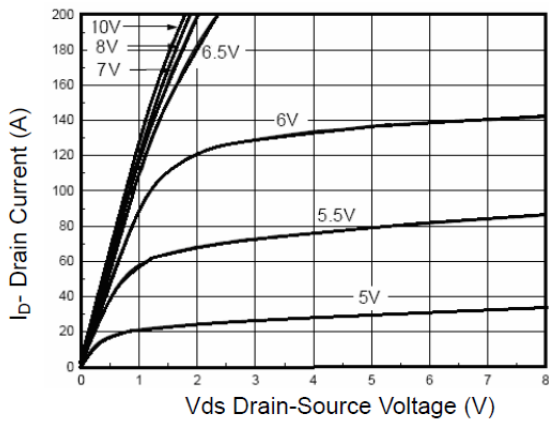

Figure 1 Output Characteristics

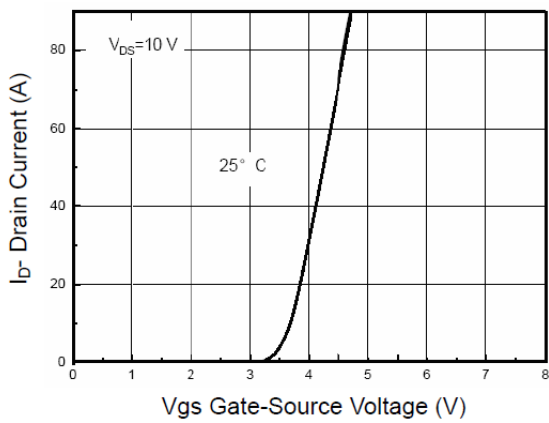

Figure 2 Transfer Characteristics

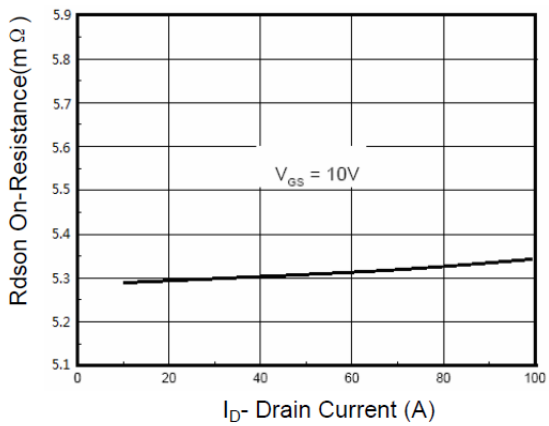

Figure 3 Rdson- Drain Current

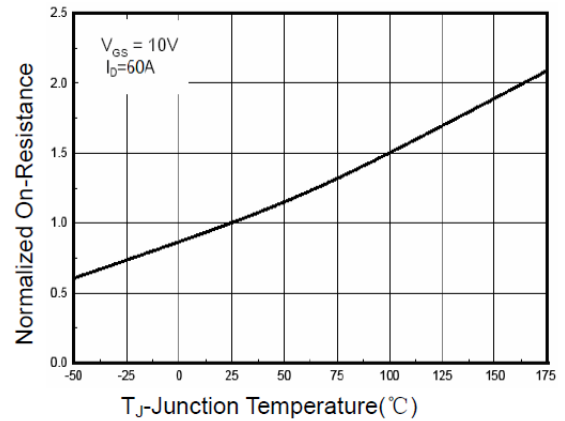

Figure 4 Rdson-Junction Temperature

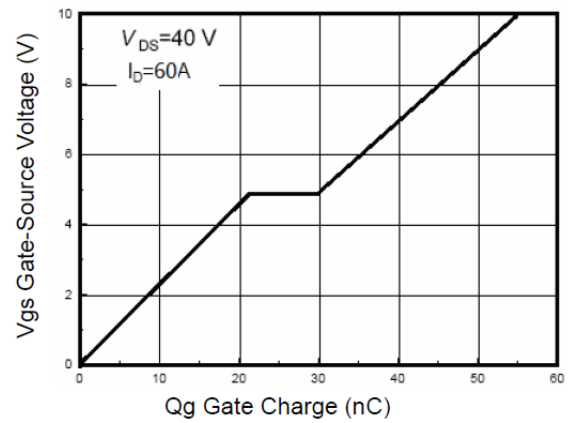

Figure 5 Gate Charge

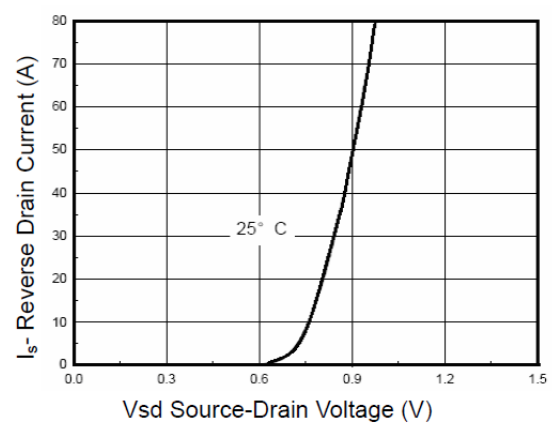

Figure 6 Source- Drain Diode Forward

Typical Characteristics

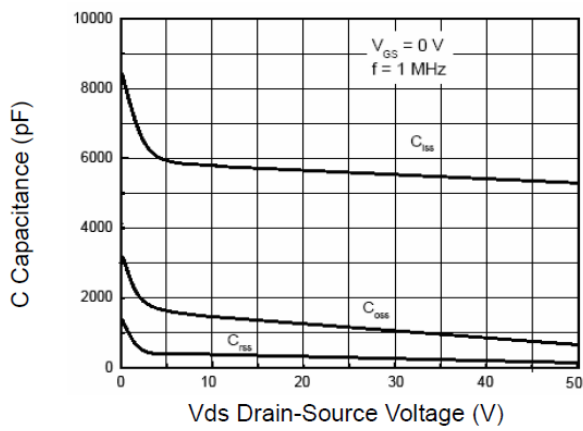

Figure 7 Capacitance vs Vds

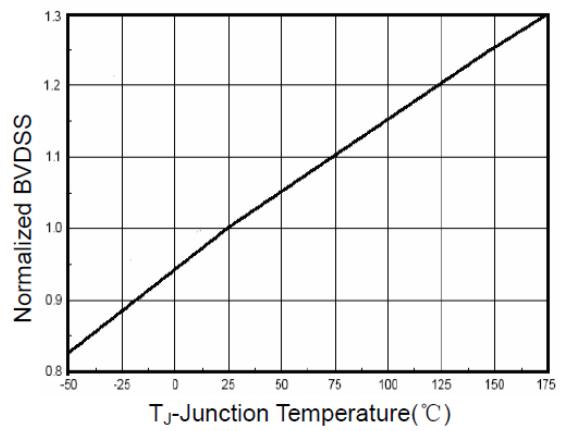

Figure 9  $BV_{DSS}$  vs Junction Temperature

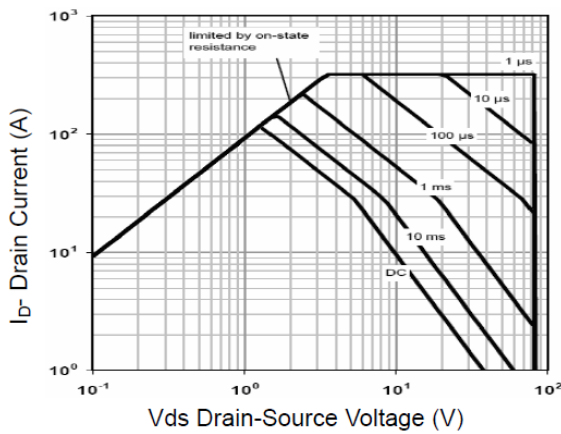

Figure 8 Safe Operation Area

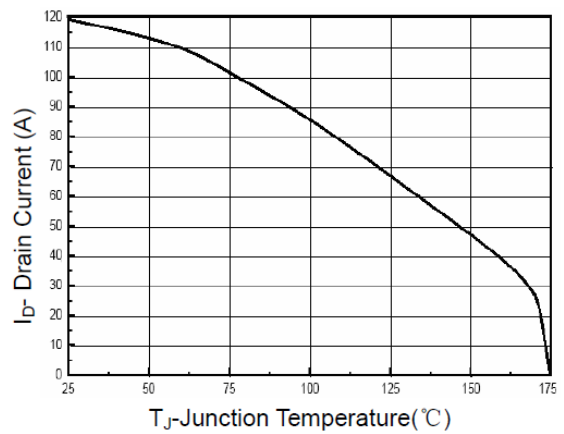

Figure 10 Current De-rating

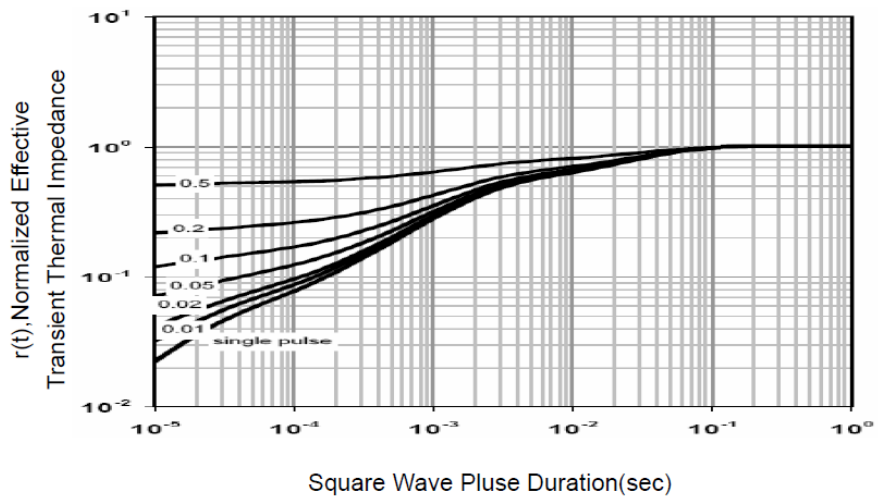
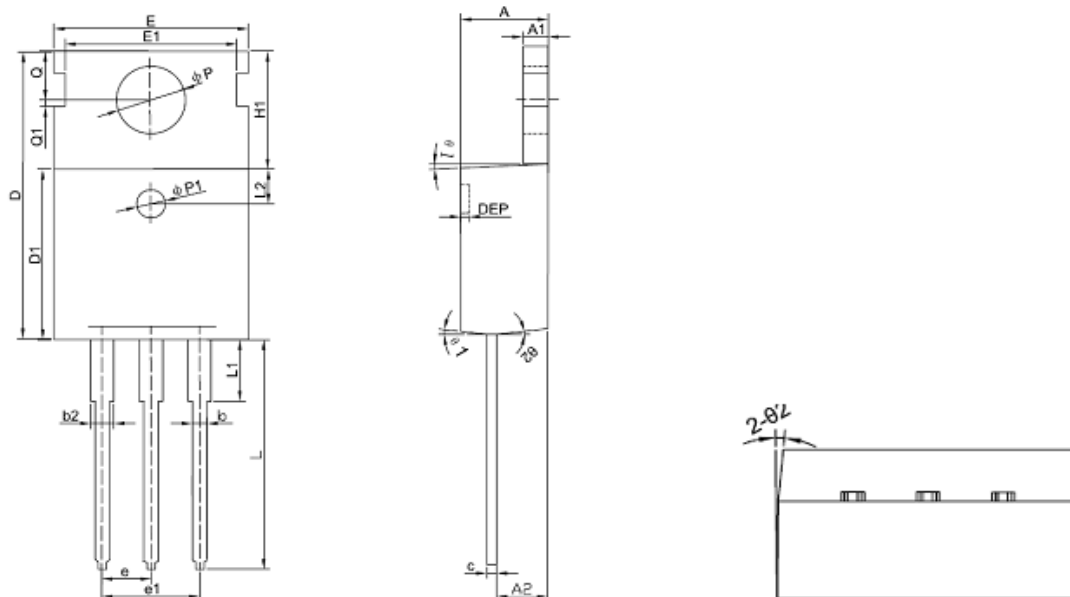

Figure 11 Normalized Maximum Transient Thermal Impedance

# SE80130G

## Package Outline Dimension

### TO-220



Symbol	Dimension In Millimeters			Dimension In Inches		
	Min	Nom	Max	Min	Nom	Max
A	4.400	4.550	4.700	0.173	0.179	0.185
A1	1.270	1.300	1.330	0.050	0.051	0.052
A2	2.590	2.690	2.790	0.102	0.106	0.110
b	0.770	-	0.900	0.030	-	0.035
b2	1.230	-	1.360	0.048	-	0.054
c	0.480	0.500	0.520	0.019	0.020	0.020
D	15.100	15.400	15.700	-	0.606	-
D1	9.000	9.100	9.200	0.354	0.358	0.362
DEP	0.050	0.285	0.520	0.002	0.011	0.020
E	10.060	10.160	10.260	0.396	0.400	0.404
E1	-	8.700	-	-	0.343	-
$\Phi P1$	1.400	1.500	1.600	0.055	0.059	0.063
e	2.54BSC			0.1BSC		
e1	5.08BSC			0.2BSC		
H1	6.100	6.300	6.500	0.240	0.248	0.256
L	12.750	12.960	13.170	0.502	0.510	0.519
L1	-	-	3.950	-	-	0.156
L2	1.85REF			0.073REF		
$\Phi P$	3.570	3.600	3.630	0.141	0.142	0.143
Q	2.730	2.800	2.870	0.107	0.110	0.113
Q1	-	0.200	-	-	0.008	-
$\theta 1$	5 <sup>0</sup>	7 <sup>0</sup>	9 <sup>0</sup>	5 <sup>0</sup>	7 <sup>0</sup>	9 <sup>0</sup>
$\theta 2$	1 <sup>0</sup>	3 <sup>0</sup>	5 <sup>0</sup>	1 <sup>0</sup>	3 <sup>0</sup>	5 <sup>0</sup>

# SE80130G

## Package Outline Dimension

### TO-263

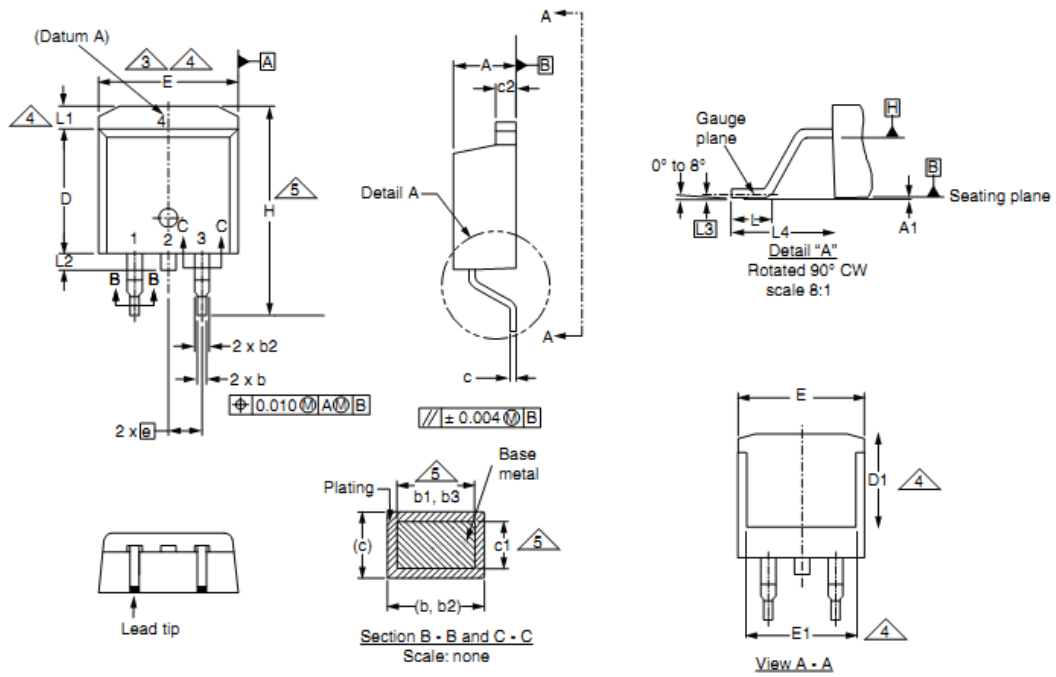

DIM.	MILLIMETERS		INCHES	
	MIN.	MAX.	MIN.	MAX.
A	4.06	4.83	0.160	0.190
A1	0.00	0.25	0.000	0.010
b	0.51	0.99	0.020	0.039
b1	0.51	0.89	0.020	0.035
b2	1.14	1.78	0.045	0.070
b3	1.14	1.73	0.045	0.068
c	0.38	0.74	0.015	0.029
c1	0.38	0.58	0.015	0.023
c2	1.14	1.65	0.045	0.065
D	8.38	9.65	0.330	0.380

DIM.	MILLIMETERS		INCHES	
	MIN.	MAX.	MIN.	MAX.
D1	6.86	-	0.270	-
E	9.65	10.67	0.380	0.420
E1	6.22	-	0.245	-
e	2.54 BSC		0.100 BSC	
H	14.61	15.88	0.575	0.625
L	1.78	2.79	0.070	0.110
L1	-	1.65	-	0.066
L2	-	1.78	-	0.070
L3	0.25 BSC		0.010 BSC	
L4	4.78	5.28	0.188	0.208

**The SINO-IC logo is a registered trademark of ShangHai Sino-IC Microelectronics Co., Ltd.**

**© 2005 SINO-IC – Printed in China – All rights reserved.**

**SHANGHAI SINO-IC MICROELECTRONICS CO., LTD**

**Add:** Building 3, Room 3401-03, No.200 Zhangheng Road, ZhangJiang Hi-Tech Park, Pudong,  
Shanghai 201203, China

**Phone:** +86-21-33932402 33932403 33932405 33933508 33933608

**Fax:** +86-21-33932401

**Email:** [webmaster@sino-ic.net](mailto:webmaster@sino-ic.net)

**Website:** <http://www.sino-ic.net>