

Features

- Push-pull latching system
- Chrome plated Brass
- IP68
- 360° Screening for full EMC shielding

RS PRO Industrial Circular Connectors

RS Stock No.: 2406590



RS PRO is the own brand of RS. The RS PRO Seal of Approval is your assurance of professional quality, a guarantee that every part is rigorously tested, inspected, and audited against demanding standards. Making RS PRO the Smart Choice for our customers.

Product Description

RS Pro's range of waterproof Chrome plated Brass push-pull locking connectors offer exceptional quality that is found in many cutting-edge connectors, including an IP68 rating and full 360° EMC shielding with a high mating life. As has become standard within the RS Pro brand you can expect high quality products but at a reasonable price. These connectors are ideal for use in medical devices, testing equipment, audio equipment and other high-end applications.

General Specifications

Number of Contacts	12
Housing Material	Chrome Plated Brass
Contact Material	Brass
Contact Plating	Gold
Contact Gender	Male
Mating Type	Cable Mount
Body Orientation	Straight
Contact Carrier	PPS
Mating Cycles	>5,000
Colour	Natural
Application	Instrumentation, Process control, Robotics, Assembly lines and manufacturing, Factory automation, Industrial production and automation, Medical devices

Electrical Specifications

Plug/Socket	Socket
Current Rating	4.2A
Test Voltage Contact-Shell k/vAC	1.40
Test Voltage Contact – Contact k/v AC	1.50

Mechanical Specifications

Connector Size	AF
Termination Method	Solder
Mounting Type	Panel Mount
Cable Outer Diameter	4.7

Operation Environment Specifications

Operating Temperature	-55°C to +250°C
-----------------------	-----------------

Protection Category

IP Rating	IP68
-----------	------

Approvals

Compliance/Certifications	RoHS, CE
---------------------------	----------

FOR MATING PARTS, SEE MATRIX:



RM-F Series AF

Plug Cable End			Mates With	Panel Mount			Or	In-Line Cable End		
RS Stock No.	No. of Contacts	Gender		RS Stock No.	No. of Contacts	Gender		RS Stock No.	No. of Contacts	Gender
2406588	10	Male	"	2406435	10	Female	"	2406520	10	Female
2406590	12	Male	"	2406436	12	Female	"	2406521	12	Female
2406591	15	Male	"	2406437	15	Female	"	2406522	15	Female
2406592	19	Male	"	2406439	19	Female	"	2406523	19	Female

The RS PRO Seal of Approval is only awarded after a rigorous quality process to demanding international standards.



Your smart choice

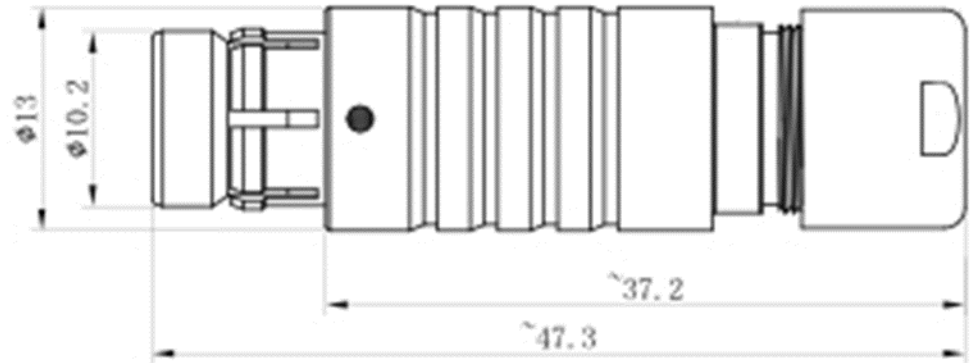

CONNECTOR SOLDER CUP VIEW

● — RED



10 ($\phi 0.7$)



12 ($\phi 0.7$)



2 ($\phi 1.3$)
13 ($\phi 0.5$)



19 ($\phi 0.5$)