

Features

- ◆ 100W peak pulse power(8/20μs)
- ◆ Protects two line pairs(four lines)
- ◆ Ultra low leakage: nA level
- ◆ Low operating voltage: 2.8V
- ◆ Low capacitance
- ◆ Ultra low clamping voltage
- ◆ JEDEC SO-8 package
- ◆ Complies with following standards:
 - IEC 61000-4-2 (ESD) immunity test
 - Air discharge: ±30kV
 - Contact discharge: ±30kV
 - IEC61000-4-4 (EFT) 40A (5/50ns)
 - IEC61000-4-5 (Lightning) 10A (8/20μs)
- ◆ RoHS Compliant

Mechanical Characteristics

- ◆ Package: SO-8
- ◆ Lead Finish: Matte Tin
- ◆ Case Material: “Green” Molding Compound.
- ◆ UL Flammability Classification Rating 94V-0
- ◆ Moisture Sensitivity: Level 3 per J-STD-020
- ◆ Terminal Connections: See Diagram Below



Applications

- ◆ Base Station
- ◆ Analog Inputs
- ◆ Switch Systems
- ◆ 10/100/1000 Ethernet
- ◆ WAN/LAN Equipment
- ◆ Desktops, Servers, and Notebooks
- ◆ Low Voltage Interfaces

Ordering Information

Part Number	Qty per Reel	Reel Size
SLVU2.8-4-TP	2500	13Inch

Dimensions and Pin Configuration

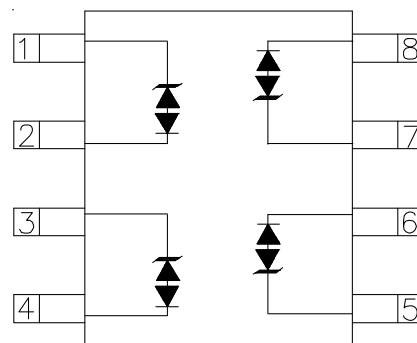

Circuit and Pin Schematic

Absolute Maximum Ratings ($T_A=25^{\circ}\text{C}$ unless otherwise specified)

Parameter	Symbol	Value	Unit
Peak Pulse Power(8/20 μs)	Ppk	100	W
Peak Pulse Current(8/20 μs)	I _{PP}	10	A
ESD per IEC 61000-4-2 (Air) ESD per IEC 61000-4-2 (Contact)	V _{ESD}	± 30 ± 30	kV
Operating Temperature Range	T _J	-40 to +125	$^{\circ}\text{C}$
Storage Temperature Range	T _{stg}	-55 to +150	$^{\circ}\text{C}$

Electrical Characteristics ($T_A=25^{\circ}\text{C}$ unless otherwise specified)

Parameter	Symbol	Min	Typ	Max	Unit	Test Condition
Reverse Working Voltage	V _{RWM}			2.8	V	
Punch-Through Voltage	V _{PT}	3.5	3.8	4.3	V	I _{PT} = 2 μA
Snap-Back Voltage	V _{SB}	2.8				I _{SB} = 50mA
Reverse Leakage Current	I _R			1.0	μA	V _{RWM} = 2.8V
Clamping Voltage	V _C			5.5	V	I _{PP} = 1A (8 x 20 μs pulse)
Clamping Voltage	V _C			10	V	I _{PP} = 10A (8 x 20 μs pulse)
Variation in capacitance with reverse bias			1.3		pF	Pins 1,8 to 2,7 and pins 3,6 to 4,5 V _R = 0 to 2.8V, f = 1MHz
Junction Capacitance	C _J		4.7	6	pF	Pins 1,8 to 2,7 and pins 3,6 to 4,5 V _R = 2.8V, f = 1MHz

PROTECTION PRODUCTS
Typical characteristics

Non-Repetitive Peak Pulse Power vs. Pulse Time

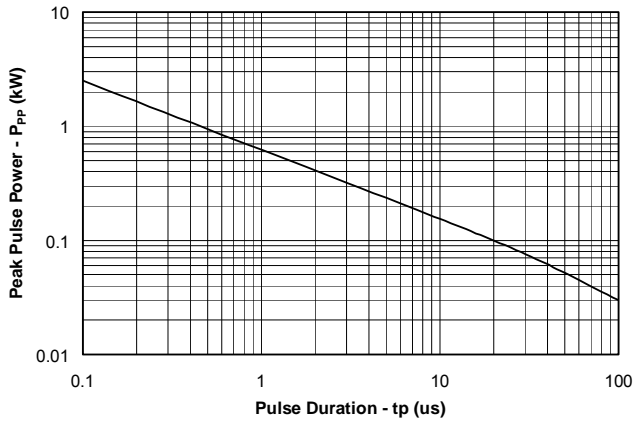

Clamping Voltage vs. Peak Pulse Current

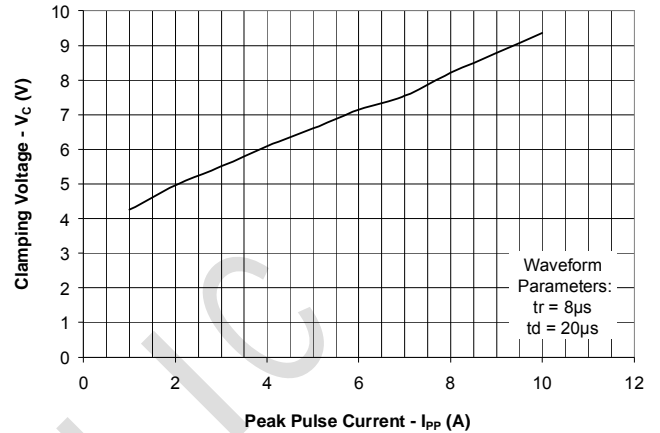

Normalized Junction Capacitance vs. Reverse Voltage

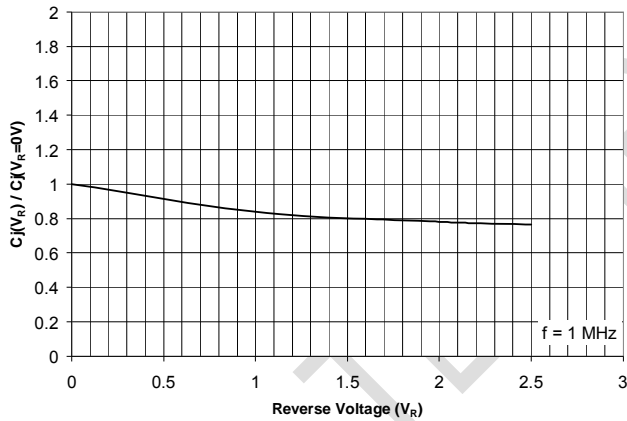

Typical Insertion Loss (S21)

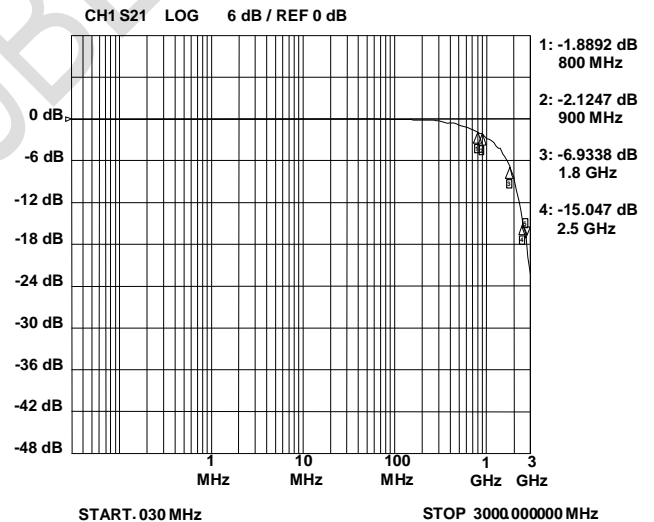

ESD Clamping
(8kV Contact per IEC 61000-4-2)

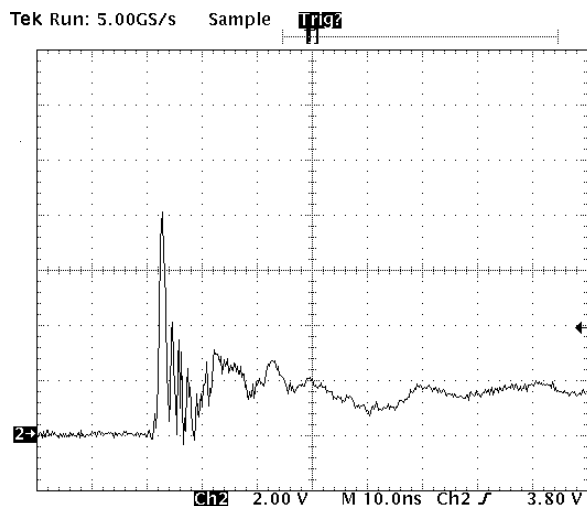

Note: Data is taken with a 10x attenuator

ESD Clamping
(-8kV Contact per IEC 61000-4-2)

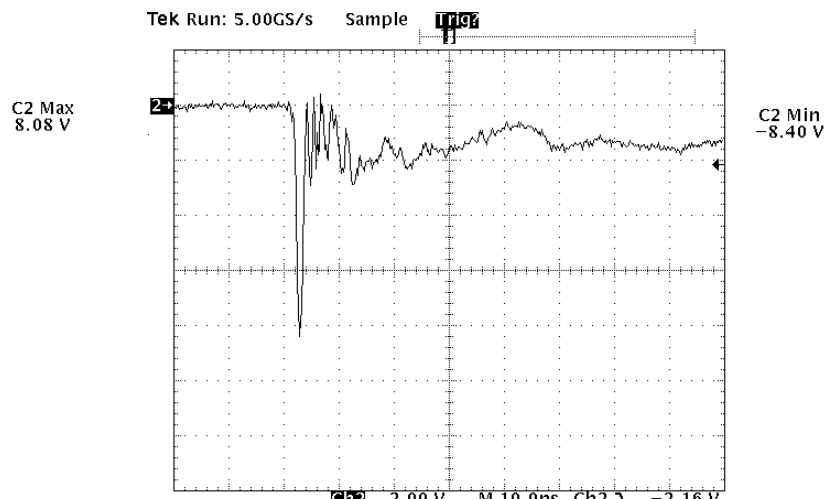

Note: Data is taken with a 10x attenuator

Outline Drawing - SOP-8

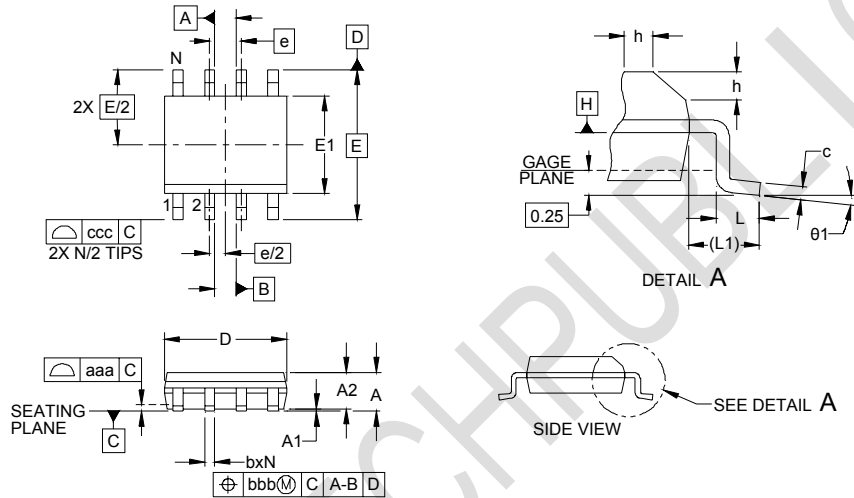

DIM	INCHES			MILLIMETERS		
	MIN	NOM	MAX	MIN	NOM	MAX
A	.053	-	.069	1.35	-	1.75
A1	.004	-	.010	0.10	-	0.25
A2	.049	-	.065	1.25	-	1.65
b	.012	-	.020	0.31	-	0.51
c	.007	-	.010	0.17	-	0.25
D	.189	.193	.197	4.80	4.90	5.00
E1	.150	.154	.157	3.80	3.90	4.00
E	.236 BSC			6.00 BSC		
e	.050 BSC			1.27 BSC		
h	.010	-	.020	0.25	-	0.50
L	.016	.028	.041	0.40	0.72	1.04
L1	(.041)			(1.04)		
N	8			8		
θ1	0°	-	8°	0°	-	8°
aaa	.004			0.10		
bbb	.010			0.25		
ccc	.008			0.20		

Land Pattern - SOP-8

