

N-Ch 80V Fast Switching MOSFETs
Description

The HSBA8048 is the high cell density trenched N-ch MOSFETs, which provide excellent R_{DS(ON)} and gate charge for most of the synchronous rectification applications.

The HSBA8048 meet the RoHS and Halogen-Free compliant product requirement, 100% EAS guaranteed with full function reliability approved.

- 100% EAS Guaranteed
- Green Device Available
- Super Low Gate Charge
- Excellent CdV/dt effect decline
- Advanced high cell density Trench technology

Product Summary

V _{DS}	80	V
R _{DS(ON),TYP}	4.3	mΩ
I _D	48	A

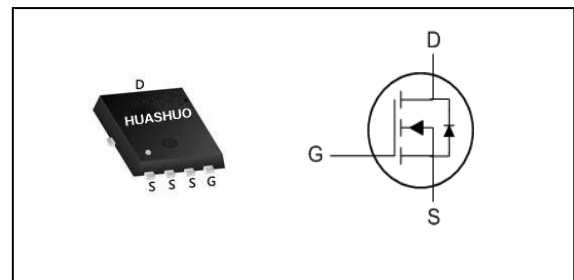
PRPAK5X6 Pin Configuration

Absolute Maximum Ratings

Symbol	Parameter	Rating	Units
V _{DS}	Drain-Source Voltage	80	V
V _{GS}	Gate-Source Voltage	±20	V
I _D @T _C =25°C	Continuous Drain Current, V _{GS} @ 10V ^{1,6}	48	A
I _D @T _C =100°C	Continuous Drain Current, V _{GS} @ 10V ^{1,6}	42.5	A
I _{DM}	Pulsed Drain Current ²	170	A
EAS	Single Pulse Avalanche Energy ³	57.8	mJ
I _{AS}	Avalanche Current	34	A
P _D @T _C =25°C	Total Power Dissipation ⁴	56	W
T _{STG}	Storage Temperature Range	-55 to 150	°C
T _J	Operating Junction Temperature Range	-55 to 150	°C

Thermal Data

Symbol	Parameter	Typ.	Max.	Unit
R _{θJA}	Thermal Resistance Junction-Ambient ¹	---	62	°C/W
R _{θJC}	Thermal Resistance Junction-Case ¹	---	2.2	°C/W

Electrical Characteristics (T_J=25 °C, unless otherwise noted)

Symbol	Parameter	Conditions	Min.	Typ.	Max.	Unit
BV _{DSS}	Drain-Source Breakdown Voltage	V _{GS} =0V, I _D =250uA	80	---	---	V
R _{DS(ON)}	Static Drain-Source On-Resistance ²	V _{GS} =10V, I _D =20A	---	4.3	6.5	mΩ
R _{DS(ON)}	Static Drain-Source On-Resistance ²	V _{GS} =4.5V, I _D =20A	---	6.3	8.5	mΩ
V _{GS(th)}	Gate Threshold Voltage	V _{GS} =V _{DS} , I _D =250uA	1.2	---	2.3	V
I _{DSS}	Drain-Source Leakage Current	V _{DS} =64V, V _{GS} =0V, T _J =25°C	---	---	1	uA
		V _{DS} =64V, V _{GS} =0V, T _J =55°C	---	---	5	
I _{GSS}	Gate-Source Leakage Current	V _{GS} =±20V, V _{DS} =0V	---	---	±100	nA
g _{fs}	Forward Transconductance	V _{DS} =5V, I _D =20A	---	75	---	S
R _g	Gate Resistance	V _{DS} =0V, V _{GS} =0V, f=1MHz	---	0.5	---	Ω
Q _g	Total Gate Charge (10V)	V _{DS} =40V, V _{GS} =10V, I _D =20A	---	40	---	nC
Q _{gs}	Gate-Source Charge		---	7.2	---	
Q _{gd}	Gate-Drain Charge		---	6.5	---	
T _{d(on)}	Turn-On Delay Time	V _{DD} =40V, V _{GS} =10V, R _G =3Ω, I _D =20A	---	8.3	---	ns
T _r	Rise Time		---	4.2	---	
T _{d(off)}	Turn-Off Delay Time		---	36	---	
T _f	Fall Time		---	6.9	---	
C _{iss}	Input Capacitance	V _{DS} =40V, V _{GS} =0V, f=1MHz	---	2860	---	pF
C _{oss}	Output Capacitance		---	410	---	
C _{rss}	Reverse Transfer Capacitance		---	38	---	

Diode Characteristics

Symbol	Parameter	Conditions	Min.	Typ.	Max.	Unit
I _S	Continuous Source Current ^{1,5}	V _G =V _D =0V, Force Current	---	---	48	A
V _{SD}	Diode Forward Voltage ²	V _{GS} =0V, I _S =A, T _J =25°C	---	0.77	1.0	V
t _{rr}	Reverse Recovery Time	I _F =20A, dI/dt=100A/μs,	---	27	---	nS
Q _{rr}	Reverse Recovery Charge	T _J =25°C	---	89	---	nC

Note :

- 1.The data tested by surface mounted on a 1 inch² FR-4 board with 2OZ copper.
- 2.The data tested by pulsed, pulse width ≤ 300us, duty cycle ≤ 2%
- 3.The EAS data shows Max. rating. The test condition is V_{DD}=25V, V_{GS}=10V, L=0.1mH, I_{AS}=34A
- 4.The power dissipation is limited by 150°C junction temperature
- 5.The data is theoretically the same as I_D and I_{DM}, in real applications, should be limited by total power dissipation.
- 6.The maximum current rating is package limited.

Typical Characteristics

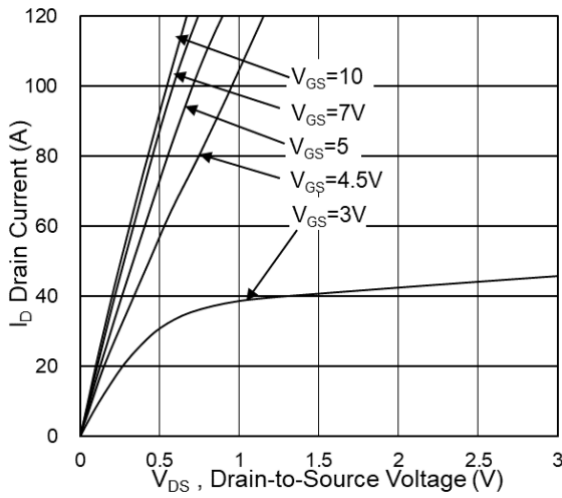

Fig.1 Typical Output Characteristics

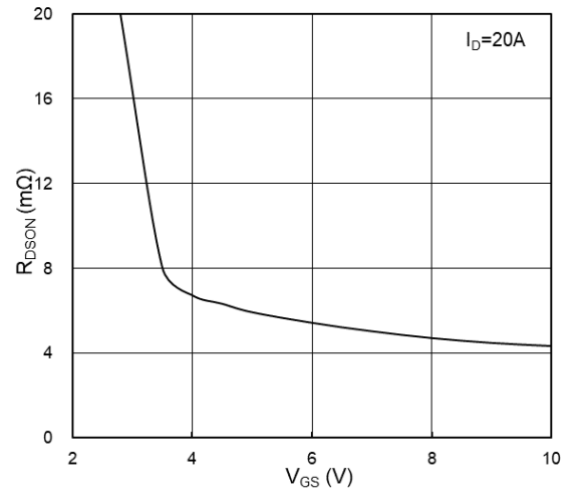

Fig.2 On-Resistance vs G-S Voltage

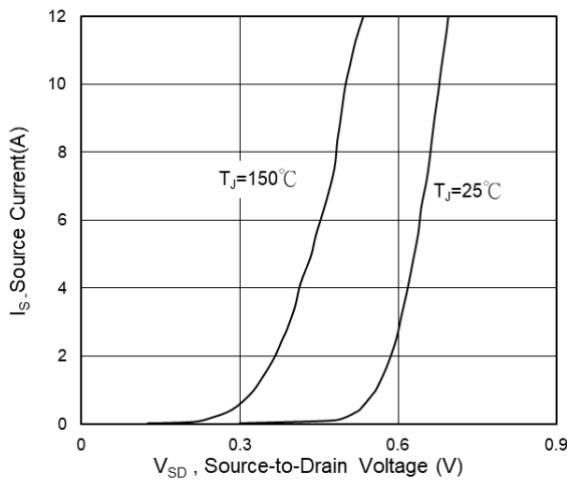

Fig.3 Source Drain Forward Characteristics

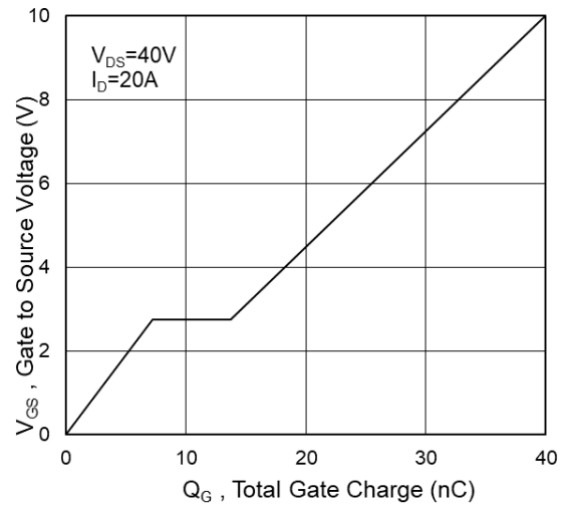

Fig.4 Gate-Charge Characteristics

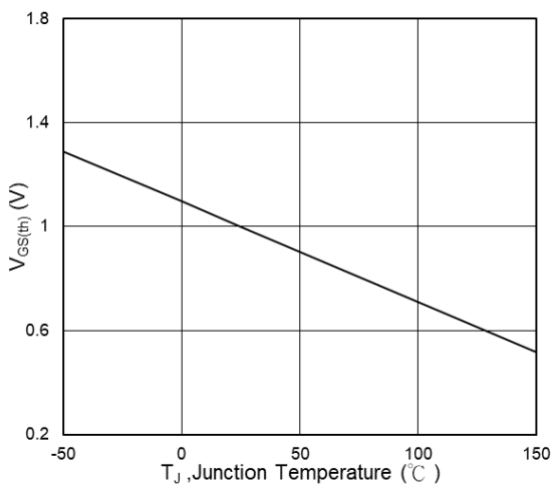

Fig.5 Normalized $V_{GS(th)}$ vs. T_J

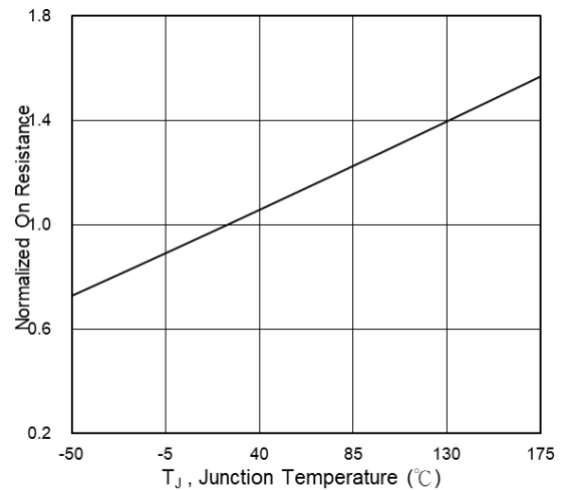

Fig.6 Normalized R_{DSON} vs. T_J

N-Ch 80V Fast Switching MOSFETs

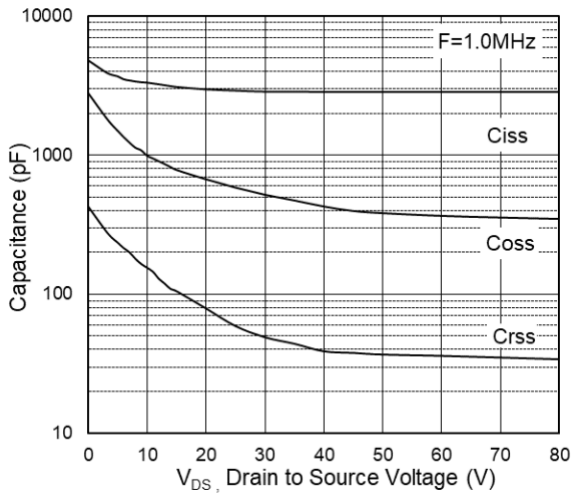

Fig.7 Capacitance

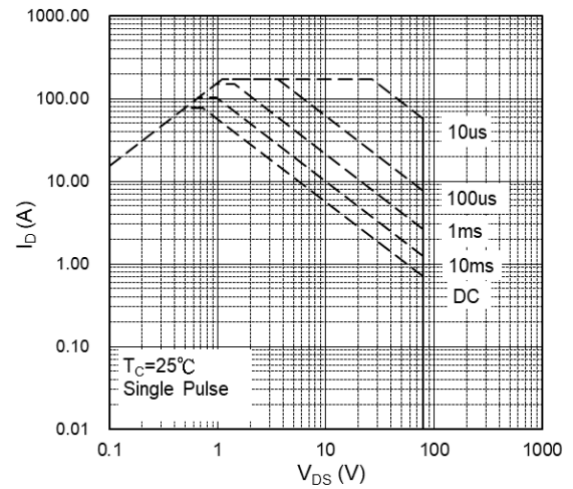

Fig.8 Safe Operating Area

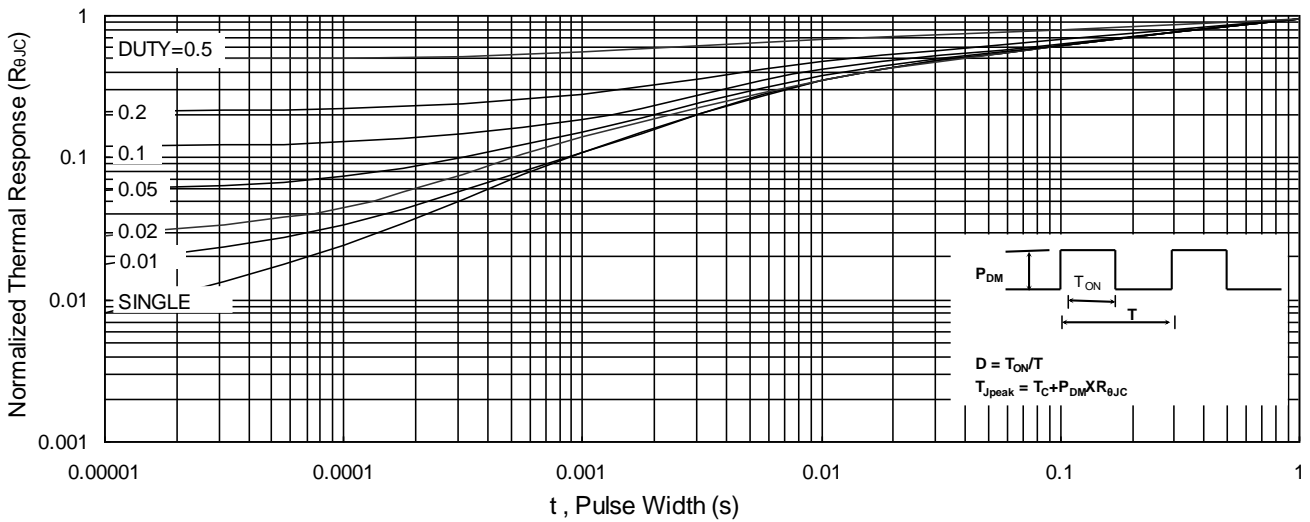

Fig.9 Normalized Maximum Transient Thermal Impedance

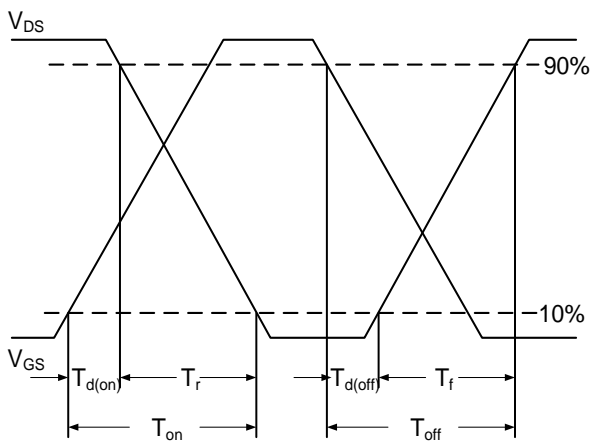

Fig.10 Switching Time Waveform

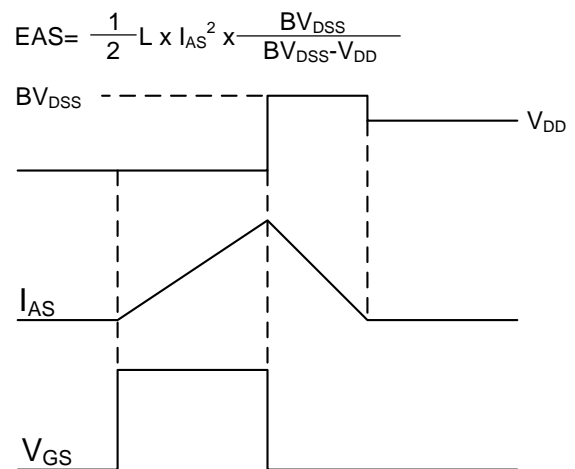

Fig.11 Unclamped Inductive Switching Waveform