

4.7mm Round With Housing

multicomp PRO

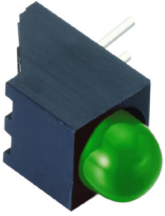

Specifications

Dice Material	: GaP
Peak Wave Length	: 568 nm
Emitted Colour	: Green
Viewing Angle	: 45°
Lens Colour	: Green Diffused
IV(mcd)	: 35

Electrical / Optical Characteristics at $T_A = 25^\circ\text{C}$

Parameter	Symbol	Min	Typ	Max	Unit	Test
Luminous Intensity	IV	20	35	50	mcd	IF = 20mA
Viewing Angle	$2\theta_{1/2}$	-	45	-	deg	
Peak Emission Wavelength	λ_p	-	568	-	nm	
Dominant Wavelength	λ_D	-	570	-	nm	
Spectral Line Half-Width	$\Delta\lambda$	-	30	-	nm	
Forward Voltage	VF	1.8	2.2	2.6	V	
Power Dissipation	Pd	-	-	85	mW	
Peak Forward Current (Duty 1/10 @ 1kHz)	IF (Peak)	-	-	100	mA	
Recommended Operating Current	TF (Rec)	-	10	-	mA	

Absolute Maximum Rating $T_A = 25^\circ\text{C}$

Reverse Voltage	5 Volt
Reverse Current	10 μ A (VR=5V)
Operating Temperature Range	-40°C to +85°C
Storage Temperature Range	-40°C to +100°C
Lead Soldering Temperature Range (1.6mm (1/16 inch) from body)	260°C For 5 Seconds

Typical Electro-Optical Characteristics Curves

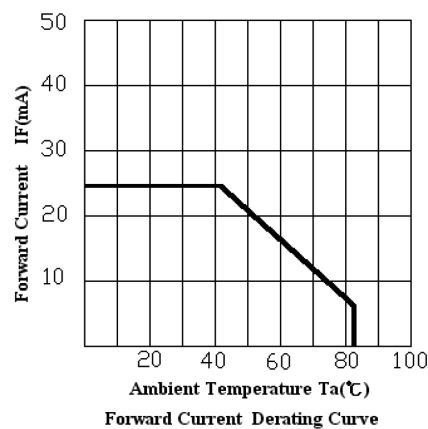
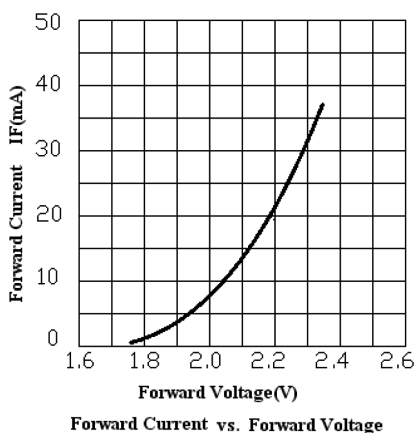

Newark.com/multicomp-pro
Farnell.com/multicomp-pro
Element14.com/multicomp-pro

multicomp PRO

4.7mm Round With Housing

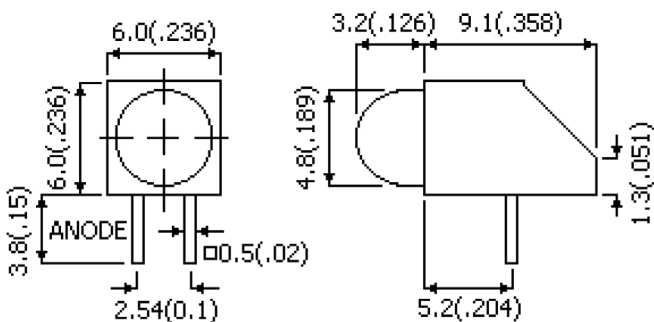
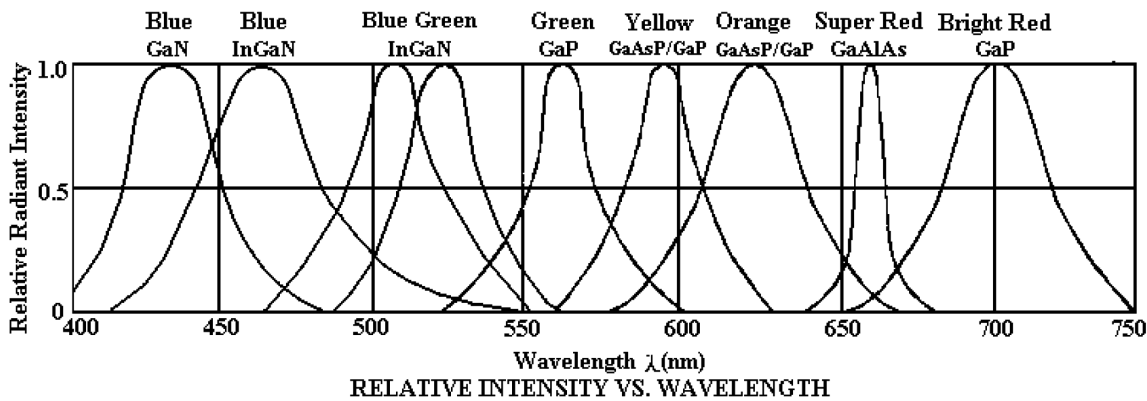
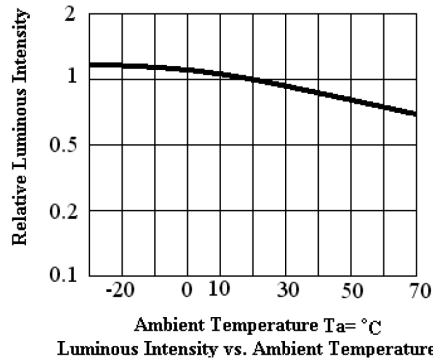
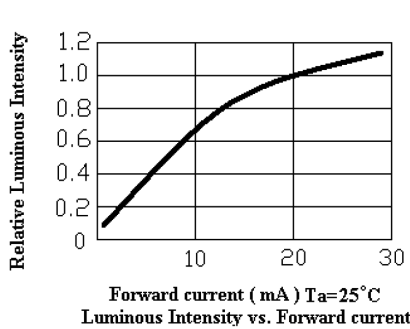

Dimensions : Millimetres
Tolerance : ±0.25mm

Part Number Table

Description	Part Number
4.7mm Round Type With Housing, Green Diffused	L383HGD

Important Notice : This data sheet and its contents (the "Information") belong to the members of the AVNET group of companies (the "Group") or are licensed to it. No licence is granted for the use of it other than for information purposes in connection with the products to which it relates. No licence of any intellectual property rights is granted. The Information is subject to change without notice and replaces all data sheets previously supplied. The Information supplied is believed to be accurate but the Group assumes no responsibility for its accuracy or completeness, any error in or omission from it or for any use made of it. Users of this data sheet should check for themselves the Information and the suitability of the products for their purpose and not make any assumptions based on information included or omitted. Liability for loss or damage resulting from any reliance on the Information or use of it (including liability resulting from negligence or where the Group was aware of the possibility of such loss or damage arising) is excluded. This will not operate to limit or restrict the Group's liability for death or personal injury resulting from its negligence. Multicomp Pro is the registered trademark of Premier Farnell Limited 2019.

Newark.com/multicomp-pro
Farnell.com/multicomp-pro
Element14.com/multicomp-pro

