

**45V NPN MEDIUM POWER HIGH GAIN TRANSISTOR**

**Product Summary**

$BV_{CEO}$	45V
$R_{SAT}$	77mΩ
$I_C$	3A

**Description and Applications**

Packaged in the TO252-3L/DPAK outline this high gain 45V NPN transistor offers low on state losses making it ideal for use in DC-DC circuits and various driving and power management functions.

- DC - DC Converters
- MOSFET gate drivers
- Charging circuits
- Power switches
- Siren drivers

**Features and Benefits**

- 3 Amps continuous current
- Up to 6 Amps peak current
- Low saturation voltages
- High gain
- Lead, Halogen, and Antimony Free, RoHS Compliant (Note 1)
- "Green" Device (Note 2)

**Mechanical Data**

- Case: TO252-3L/DPAK

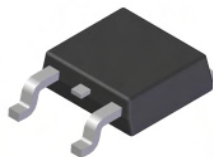

Top View

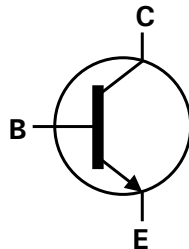

Equivalent Circuit

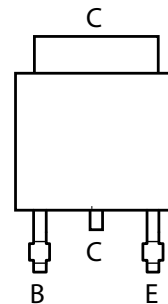

Package Pin Configuration

**Ordering Information**

Product	Marking	Reel size	Tape width	Quantity per reel
ZXT690BKTC	ZXT690B	13 in.	16mm embossed	2500 units

- Notes:
1. No purposefully added lead. Halogen and Antimony Free.
  2. Diodes Inc.'s "Green" Policy can be found on our website at <http://www.diodes.com>

**Marking Information**

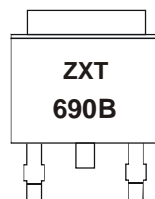

ZXT690B = Product Type Marking Code

## Maximum Ratings @ $T_A = 25^\circ\text{C}$ unless otherwise specified

Characteristic	Symbol	Value	Unit
Collector-Base Voltage	$BV_{CBO}$	60	V
Collector-Emitter Voltage	$BV_{CEO}$	45	V
Emitter-Base Voltage	$BV_{EBO}$	5	V
Continuous Collector Current	$I_C$	3	A
Peak Pulse Current	$I_{CM}$	6	A
Base Current	$I_B$	0.5	A

## Thermal Characteristics

Characteristic	Symbol	Value	Unit
Power Dissipation (Note 3) @ $T_A = 25^\circ\text{C}$ Linear Derating Factor	$P_D$	2.1 16.85	W mW/ $^\circ\text{C}$
Thermal Resistance, Junction to Ambient (Note 1)	$R_{\theta JA}$	59	$^\circ\text{C}/\text{W}$
Power Dissipation (Note 4) @ $T_A = 25^\circ\text{C}$ Linear Derating Factor	$P_D$	3.0 24.4	W mW/ $^\circ\text{C}$
Thermal Resistance, Junction to Ambient (Note 2)	$R_{\theta JA}$	41	$^\circ\text{C}/\text{W}$
Power Dissipation (Note 5) @ $T_A = 25^\circ\text{C}$ Linear Derating Factor	$P_D$	3.9 30.9	W mW/ $^\circ\text{C}$
Thermal Resistance, Junction to Ambient (Note 3)	$R_{\theta JA}$	32	$^\circ\text{C}/\text{W}$
Operating and Storage Temperature Range	$T_J, T_{STG}$	-55 to +150	$^\circ\text{C}$

- Notes:
3. For a device surface mounted on 25mm x 25mm FR4 PCB with high coverage of single sided 1oz copper, in still air conditions.
  4. For a device surface mounted on 50mm x 50mm FR4 PCB with high coverage of single sided 1oz copper in still air conditions.
  5. For a device surface mounted on 50mm x 50mm FR4 PCB with high coverage of single sided 2oz copper in still air conditions.

**Typical Characteristics**

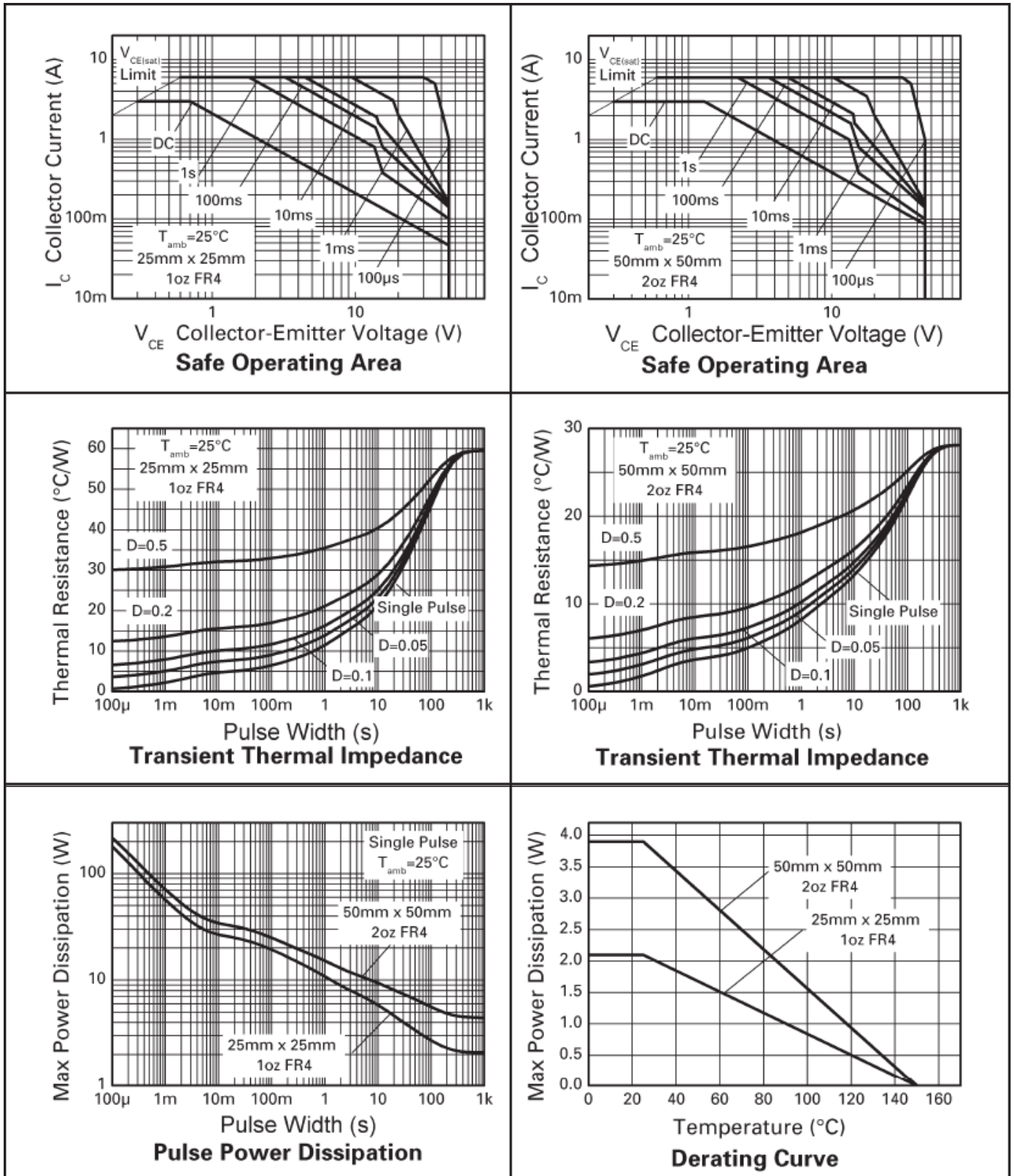

**Electrical Characteristics** @T<sub>A</sub> = 25°C unless otherwise specified

Characteristic	Symbol	Min	Typ	Max	Unit	Test Condition
Collector-Base Breakdown Voltage	BV <sub>CBO</sub>	60	145	—	V	I <sub>C</sub> = 100μA
Collector-Emitter Breakdown Voltage (Note 6)	BV <sub>CEO</sub>	45	65	—	V	I <sub>C</sub> = 10mA
Emitter-Base Breakdown Voltage	BV <sub>EBO</sub>	5	8.2	—	V	I <sub>E</sub> = 100μA
Collector Cutoff Current	I <sub>CBO</sub>	—	<1	20	nA	V <sub>CB</sub> = 35V
Collector Cutoff Current	I <sub>CES</sub>	—	<1	20	nA	V <sub>CB</sub> = 35V
Emitter Cutoff Current	I <sub>EBO</sub>	—	<1	20	nA	V <sub>EB</sub> = 4V
Collector-Emitter Saturation Voltage (Note 6)	V <sub>CE(sat)</sub>	—	50	85	mV	I <sub>C</sub> = 0.1A, I <sub>B</sub> = 0.5mA
			240	360		I <sub>C</sub> = 1A, I <sub>B</sub> = 5mA
			210	320		I <sub>C</sub> = 2A, I <sub>B</sub> = 40mA
			230	350		I <sub>C</sub> = 3A, I <sub>B</sub> = 150mA
Base-Emitter Saturation Voltage (Note 6)	V <sub>BE(sat)</sub>	—	1.0	1.2	mV	I <sub>C</sub> = 3A, I <sub>B</sub> = 150mA
Base-Emitter Turn-On Voltage (Note 6)	V <sub>BE(on)</sub>	—	0.9	1.1	mV	I <sub>C</sub> = 3A, V <sub>CE</sub> = 2V
DC Current Gain (Note 6)	h <sub>FE</sub>	—	500	—	—	I <sub>C</sub> = 100mA, V <sub>CE</sub> = 2V
			400			I <sub>C</sub> = 1A, V <sub>CE</sub> = 2V
			150			I <sub>C</sub> = 2A, V <sub>CE</sub> = 2V
			60			I <sub>C</sub> = 3A, V <sub>CE</sub> = 2V
Current Gain-Bandwidth Product	f <sub>T</sub>	—	—	—	MHz	I <sub>C</sub> = 50mA, V <sub>CE</sub> = 5V, f = 50MHz
Output Capacitance (Note 6)	C <sub>obo</sub>	—	16	—	pF	V <sub>CB</sub> = 10V, f = 1MHz
Turn-On Time	t <sub>on</sub>	—	33	—	ns	I <sub>C</sub> = 500mA, V <sub>CC</sub> = 10V,
Turn-Off Time	t <sub>off</sub>	—	1300	—	ns	I <sub>B1</sub> = I <sub>B2</sub> = 50mA

Notes: 6. Measured under pulsed conditions. Pulse width ≤ 300μs; duty cycle ≤ 2%.

**Typical Characteristics**

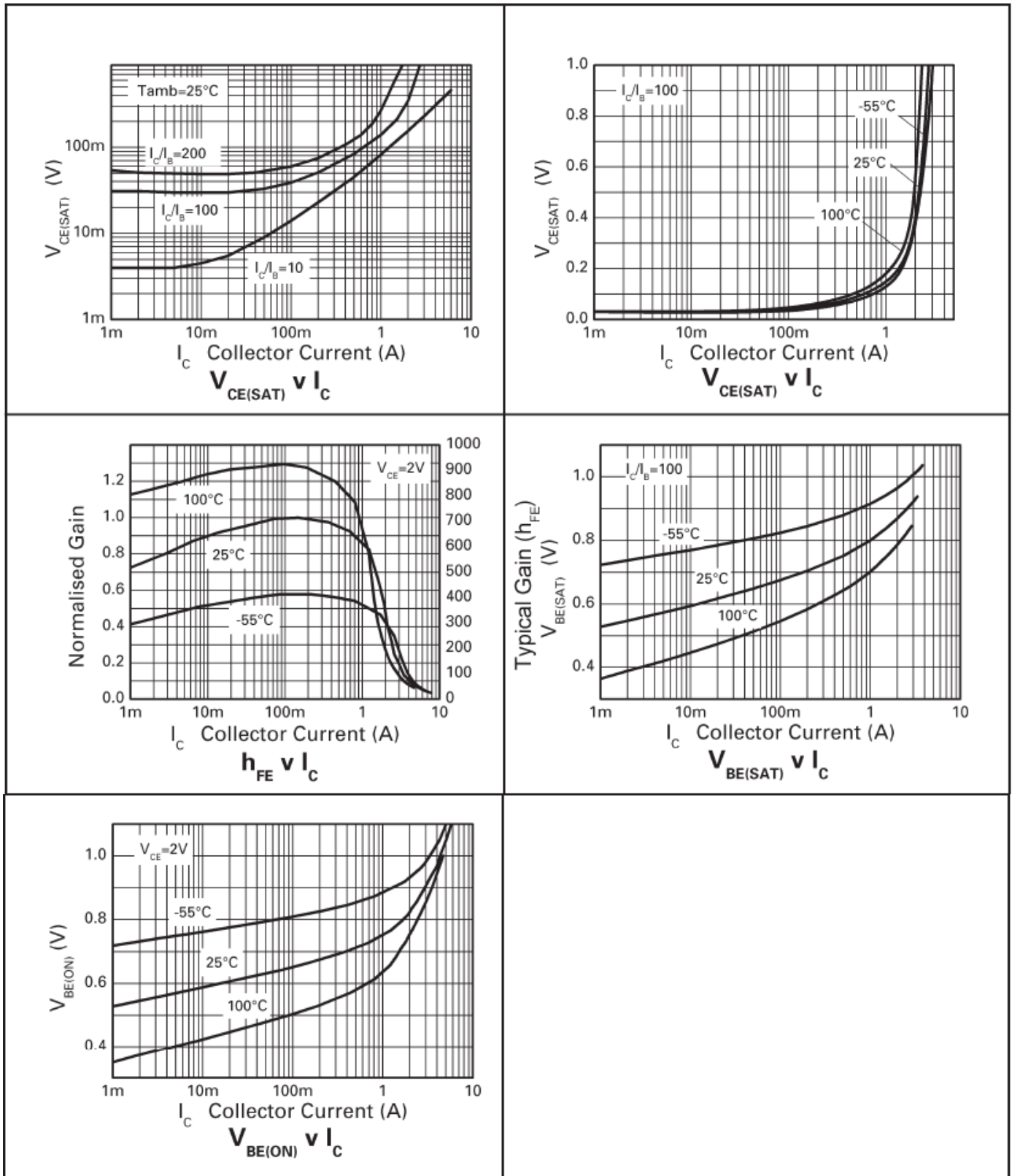

**Package Outline Dimensions**

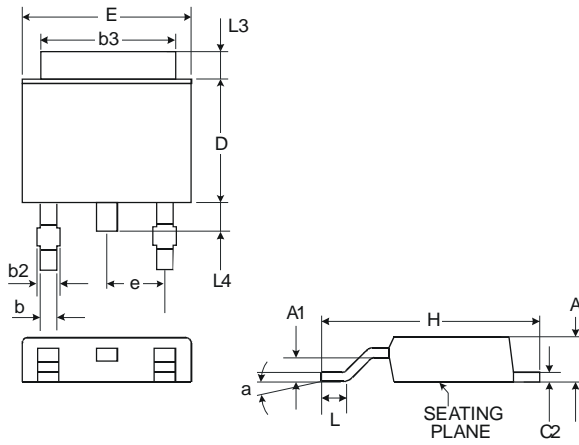

TO252-3L			
Dim	Min	Typ	Max
A	2.19	2.29	2.39
A1	0.97	1.07	1.17
b	0.64	0.76	0.88
b2	0.76	0.95	1.14
b3	5.21	5.33	5.50
C2	0.45	0.51	0.58
D	6.00	6.10	6.20
E	6.45	6.58	6.70
e	2.286 Typ.		
H	9.40	9.91	10.41
L	1.40	1.59	1.78
L3	0.88	1.08	1.27
L4	0.64	0.83	1.02
a	0°	-	10°
All Dimensions in mm			

**Package Outline Dimensions**

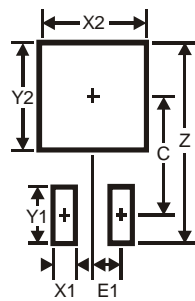

Dimensions	Value (in mm)
Z	11.6
X1	1.5
X2	7.0
Y1	2.5
Y2	7.0
C	6.9
E1	2.3

#### IMPORTANT NOTICE

DIODES INCORPORATED MAKES NO WARRANTY OF ANY KIND, EXPRESS OR IMPLIED, WITH REGARDS TO THIS DOCUMENT, INCLUDING, BUT NOT LIMITED TO, THE IMPLIED WARRANTIES OF MERCHANTABILITY AND FITNESS FOR A PARTICULAR PURPOSE (AND THEIR EQUIVALENTS UNDER THE LAWS OF ANY JURISDICTION).

Diodes Incorporated and its subsidiaries reserve the right to make modifications, enhancements, improvements, corrections or other changes without further notice to this document and any product described herein. Diodes Incorporated does not assume any liability arising out of the application or use of this document or any product described herein; neither does Diodes Incorporated convey any license under its patent or trademark rights, nor the rights of others. Any Customer or user of this document or products described herein in such applications shall assume all risks of such use and will agree to hold Diodes Incorporated and all the companies whose products are represented on Diodes Incorporated website, harmless against all damages.

Diodes Incorporated does not warrant or accept any liability whatsoever in respect of any products purchased through unauthorized sales channel. Should Customers purchase or use Diodes Incorporated products for any unintended or unauthorized application, Customers shall indemnify and hold Diodes Incorporated and its representatives harmless against all claims, damages, expenses, and attorney fees arising out of, directly or indirectly, any claim of personal injury or death associated with such unintended or unauthorized application.

Products described herein may be covered by one or more United States, international or foreign patents pending. Product names and markings noted herein may also be covered by one or more United States, international or foreign trademarks.

#### LIFE SUPPORT

Diodes Incorporated products are specifically not authorized for use as critical components in life support devices or systems without the express written approval of the Chief Executive Officer of Diodes Incorporated. As used herein:

A. Life support devices or systems are devices or systems which:

1. are intended to implant into the body, or
2. support or sustain life and whose failure to perform when properly used in accordance with instructions for use provided in the labeling can be reasonably expected to result in significant injury to the user.

B. A critical component is any component in a life support device or system whose failure to perform can be reasonably expected to cause the failure of the life support device or to affect its safety or effectiveness.

Customers represent that they have all necessary expertise in the safety and regulatory ramifications of their life support devices or systems, and acknowledge and agree that they are solely responsible for all legal, regulatory and safety-related requirements concerning their products and any use of Diodes Incorporated products in such safety-critical, life support devices or systems, notwithstanding any devices- or systems-related information or support that may be provided by Diodes Incorporated. Further, Customers must fully indemnify Diodes Incorporated and its representatives against any damages arising out of the use of Diodes Incorporated products in such safety-critical, life support devices or systems.

Copyright © 2009, Diodes Incorporated

[www.diodes.com](http://www.diodes.com)