

RPB-1ZMI-UNI

bistable - impulse relays



RPB-1ZMI-UNI



- **Bistable - impulse relays type "ON-OFF", multifunction with memory**
- **Resistance to inrush current 80 A (20 ms) ❶**
- Cadmium - free contacts 1 NO • AC/DC input voltages
- Cover - modular, width 17,5 mm
- Direct mounting on 35 mm rail mount acc. to EN 60715
- Applications: in cooperation with control switches ❷; electric systems; switchgears of modular equipment
- Compliance with standard EN 61810
- Recognitions, certifications, directives: RoHS, EMC ❸ **CE ENEC**

Output circuit - contact data

Number and type of contacts		1 NO
Contact material		AgSnO ₂
Max. switching voltage		300 V AC / 300 V DC
Rated load	AC1	16 A / 250 V AC
	DC1	16 A / 24 V DC
Max. inrush current		80 A 20 ms ❶
Rated current		16 A
Max. breaking capacity	• AC1	4 000 VA
• at halogen lamp load		2 500 W
• at LED lamp load		500 W
Min. breaking capacity		1 W 10 V, 10 mA
Contact resistance		≤ 100 mΩ
Max. operating frequency	• at rated load AC1	600 cycles/hour
	• no load	3 600 cycles/hour

Input circuit

Rated voltage	AC: 50/60 Hz AC/DC	12...240 V	terminals (+)A1, (-)A2
Must release voltage		AC: ≥ 0,15 U _n	DC: ≥ 0,05 U _n
Operating range of supply voltage		0,85...1,15 U _n	
Rated power consumption		≤ 1,8 W	
Control contact S ❸	• load	no	
	• min. voltage ❹	0,85 U _n	
	• min. time of pulse duration ❺	≥ 55 ms	

Insulation according to EN 60664-1

Insulation rated voltage		250 V AC
Rated surge voltage		4 000 V 1,2 / 50 μs
Overvoltage category		III
Insulation pollution degree		2
Flammability class		V-0 for modular cover, UL 94
Dielectric strength	• input - output	4 000 V AC
	• contact clearance	1 000 V AC
		type of insulation: basic
		type of clearance: micro-disconnection

General data

Operating / release time (typical values)		60 ms / 60 ms
Electrical life	• resistive AC1	0,5 x 10 ⁵ 16 A, 250 V AC ❻
Mechanical life (cycles)		10 ⁷
Operation cycle		1:1
Dimensions (L x W x H) / Weight		90 ❻ x 17,5 x 64,6 mm / 69 g
Ambient temperature	• storage	-40...+70 °C
(non-condensation and/or icing)	• operating	-20...+55 °C
Cover protection category		IP 20 EN 60529
Relative humidity		up to 85%
Shock / vibration resistance		15 g / 0,35 mm DA 10...55 Hz

Function data

Functions	SET/RESET with memory (NORMAL) SET/RESET (RESET)
LED indicator	green LED U ON - indication of supply voltage U yellow LED R ON/OFF - output relay status

❶ Contacts "inrush": high resistance to short-time surge currents occurring on switching on LED-lamps, ESL fluorescent tubes, electronic transformers, discharge lamps, etc. ❷ Control contact S provides control of switching ON/OFF of receivers (lighting or other devices) from a few different points, with the use of connected in parallel momentary (doorbell) switches; the relays cannot operate with lit-up buttons. ❸ EMC tests (electromagnetic compatibility): EN 55011, EN 61000-4-2/3/4/5/6/11. ❹ Where the control signal is recognizable. ❺ Continuous voltage applied between A1, A2, activated with the control contact S. ❻ Length with 35 mm rail catches: 98,8 mm.

RPB-1ZMI-UNI

bistable - impulse relays

Functions

SET/RESET with memory (NORMAL) - Switching ON and OFF with memory, controlled by pulses on the contact S.

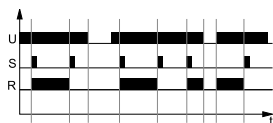

When a pulse occurs on the control input S, the output relay R is activated (SET). This status lasts until another control pulse occurs - then, the output relay R is switched off (RESET).

Further pulses which will occur on the control input S will change the R contact status into an opposite one.

In case the U supply is interrupted and then switched on again, the R contact of the output relay will return to the status prior to switching the U supply off, and the relay will start operation according to the foregoing function.

U - supply voltage; R - output state of the relay; t - time axis

SET/RESET (RESET) - Switching ON and OFF, controlled by pulses on the contact S.

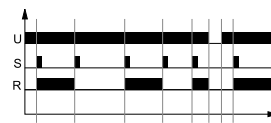

After the supply voltage has been applied, the output relay R remains switched off.

When a pulse occurs on the control input S, the output relay R is activated (SET). This status lasts until another control pulse occurs - then, the output relay R is switched off (RESET).

Further pulses which will occur on the control input S will change the R contact status into an opposite one.

Switching the supply off will cause switching the output relay R off. Switching on the supply again and applying a control pulse to the S input will switch the R relay on. Further control pulses which will occur on the control input S will change the R contact status into an opposite one.

Additional functions

LEDs: green U, yellow R - are lit permanently.

Adjustment of the set values: the function may be changed after the supply voltage has been switched off and on again. If the memory function was set, and a no-memory function is set next, the memory is cancelled in such case.

Triggering: the relay is triggered by connecting the contact S to the A1 terminal, from connected in parallel control switches. For DC supply, the positive pole must be connected to A1 terminal.

Supply: the relay may be supplied with DC voltage or AC voltage 50/60 Hz of 10,2...276 V.

Dimensions

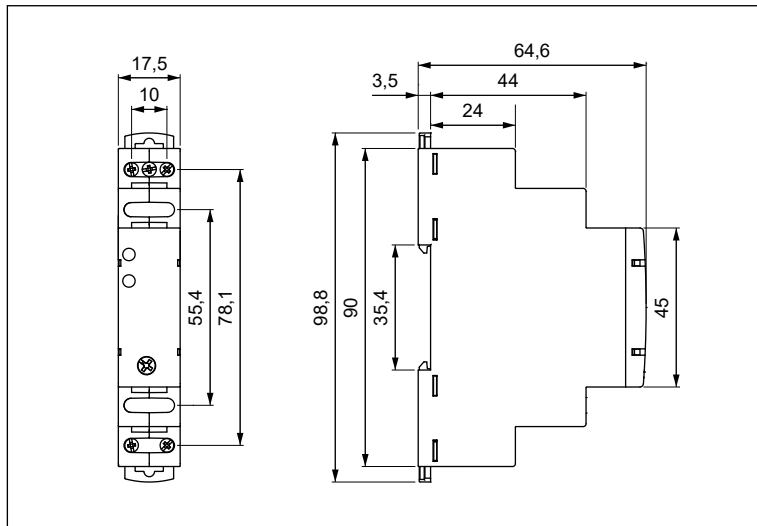

Front panel description

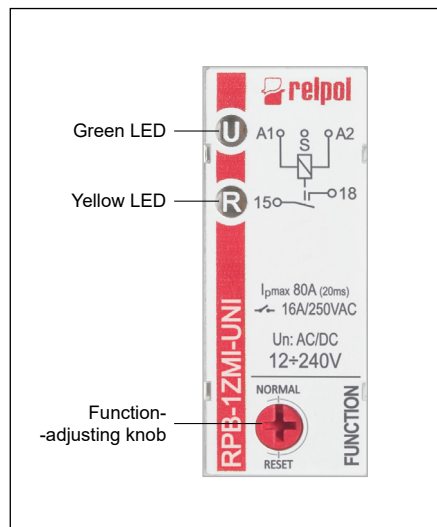

RPB-1ZMI-UNI

bistable - impulse relays

Connection diagrams

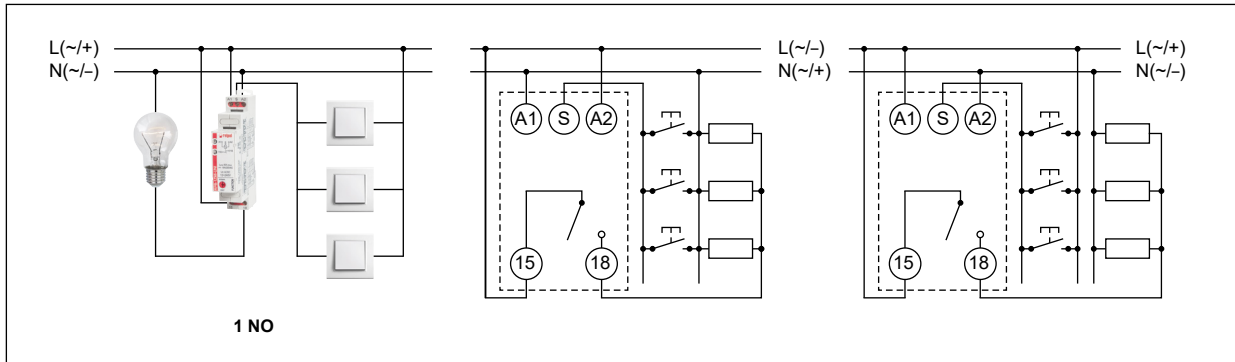

Mounting

Relays **RPB-1ZMI-UNI** are designed for direct mounting on 35 mm rail mount acc. to EN 60715. Operational position - any. **Connections:** max. cross section of the cables: 1 x 2,5 mm² (1 x 14 AWG), stripping length: 6,5 mm, max. tightening moment for the terminal: 0,5 Nm.



Two catches:
easy mounting
on 35 mm rail,
firm hold
(top and bottom).

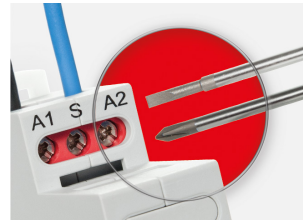

**Mounting wires
in clamps:**
universal screw
(cross-recessed
or slotted head).

Ordering codes

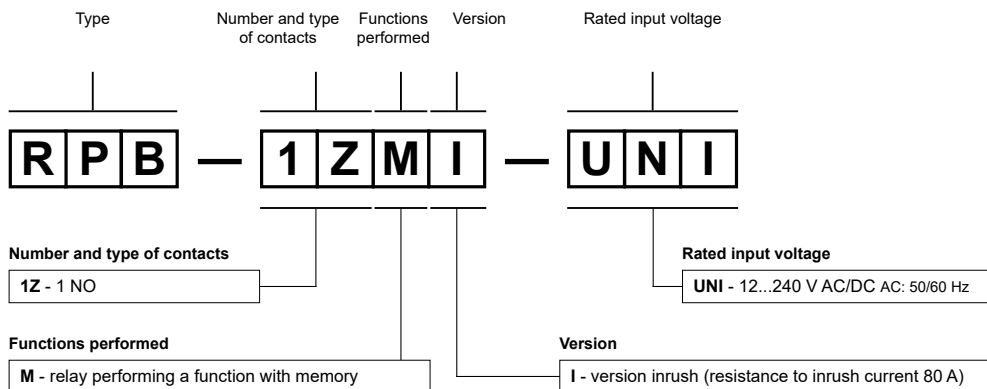

Example of ordering codes:

RPB-1ZMI-UNI

bistable - impulse relay **RPB-1ZMI-UNI**, multifunction (relay perform 2 functions), cover - modular, width 17,5 mm, one normally open contact, version inrush, contact material AgSnO₂, rated input voltage 12...240 V AC/DC AC: 50/60 Hz

PRECAUTIONS:

1. Ensure that the parameters of the product described in its specification provide a safety margin for the appropriate operation of the device or system and never use the product in circumstances which exceed the parameters of the product. 2. Never touch any live parts of the device. 3. Ensure that the product has been connected correctly. An incorrect connection may cause malfunction, excessive heating or risk of fire. 4. In case of any risk of any serious material loss or death or injuries of humans or animals, the devices or systems shall be designed so to equip them with double safety system to guarantee their reliable operation.