

Socket for Mini Relays

TE Internal #: 3-1393310-7

Socket for Mini Relays, Relay Sockets, Wiring Harness, Plug-In Mini

ISO Relays

[View on TE.com >](#)



Relays, Contactors & Switches > Relays > Automotive Relays > Automotive Plug-In Relays > Relay Sockets

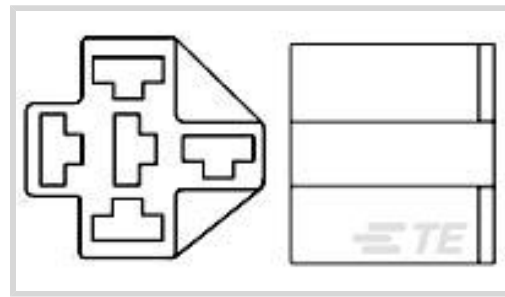

Relay Socket Type: **Wiring Harness**

Relay Socket For Use With: **Plug-In Mini ISO Relays**

Features

Product Type Features

Product Type	Socket
--------------	--------

Contact Features

Relay Socket Type	Wiring Harness
-------------------	----------------

Operation/Application

Relay Socket For Use With	Plug-In Mini ISO Relays
---------------------------	-------------------------

Other

Additional Information	Crimp Terminal Part Number 1393310-5 - Wire AWG 14-18 - Qty. Required Form C - 3, Crimp Terminal Part Number 2-1393310-1 - Wire AWG 12-16 - Qty. Required Form C - 3, Crimp Terminals Not Included. Order Separately.
------------------------	---

Product Compliance

[For compliance documentation, visit the product page on TE.com>](#)

EU RoHS Directive 2011/65/EU	Compliant
EU ELV Directive 2000/53/EC	Compliant
China RoHS 2 Directive MIIT Order No 32, 2016	No Restricted Materials Above Threshold
EU REACH Regulation (EC) No. 1907/2006	Current ECHA Candidate List: JUL 2021 (219) Candidate List Declared Against: JUL 2021 (219) Does not contain REACH SVHC
Halogen Content	Low Halogen - Br, Cl, F, I < 900 ppm per homogenous material. Also BFR/CFR/PVC

Free

Solder Process Capability

Not applicable for solder process capability

Product Compliance Disclaimer

This information is provided based on reasonable inquiry of our suppliers and represents our current actual knowledge based on the information they provided. This information is subject to change. The part numbers that TE has identified as EU RoHS compliant have a maximum concentration of 0.1% by weight in homogenous materials for lead, hexavalent chromium, mercury, PBB, PBDE, DBP, BBP, DEHP, DIBP, and 0.01% for cadmium, or qualify for an exemption to these limits as defined in the Annexes of Directive 2011/65/EU (RoHS2). Finished electrical and electronic equipment products will be CE marked as required by Directive 2011/65/EU. Components may not be CE marked. Additionally, the part numbers that TE has identified as EU ELV compliant have a maximum concentration of 0.1% by weight in homogenous materials for lead, hexavalent chromium, and mercury, and 0.01% for cadmium, or qualify for an exemption to these limits as defined in the Annexes of Directive 2000/53/EC (ELV). Regarding the REACH Regulation, the information TE provides on SVHC in articles for this part number is based on the latest European Chemicals Agency (ECHA) 'Guidance on requirements for substances in articles' posted at this URL: <https://echa.europa.eu/guidance-documents/guidance-on-reach>

Compatible Parts



Also in the Series | Socket for Mini Relays

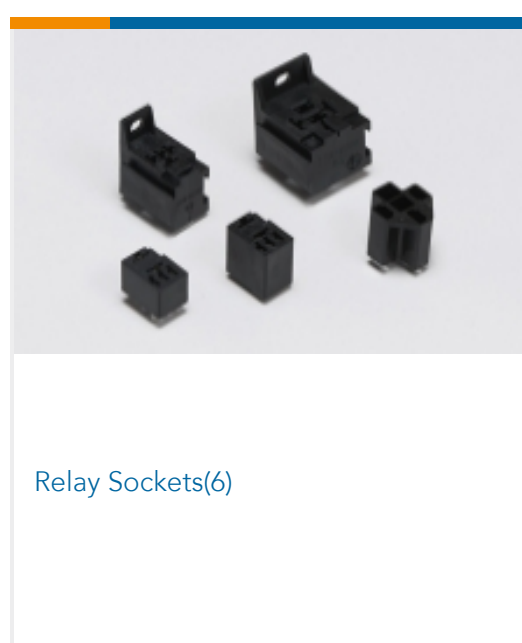

Customers Also Bought

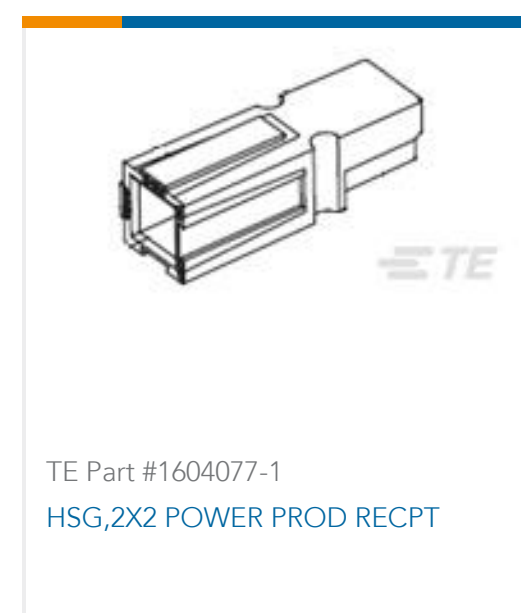
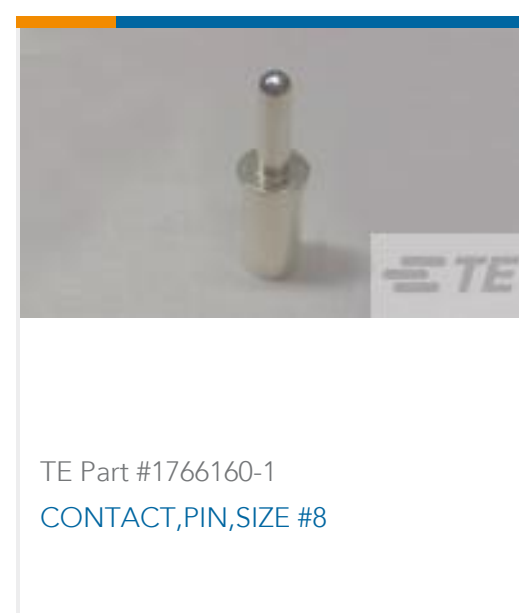

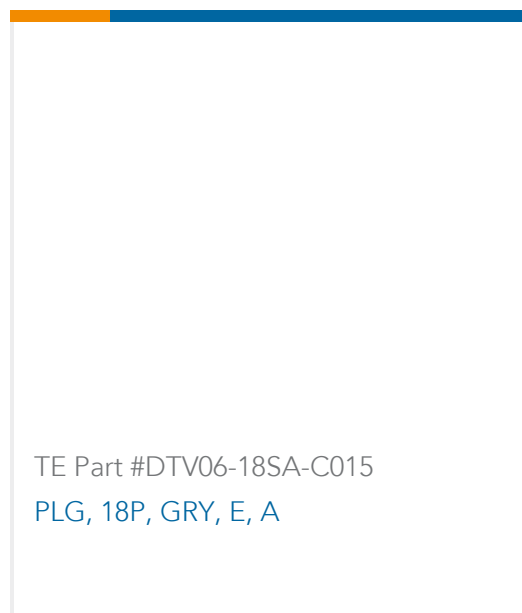
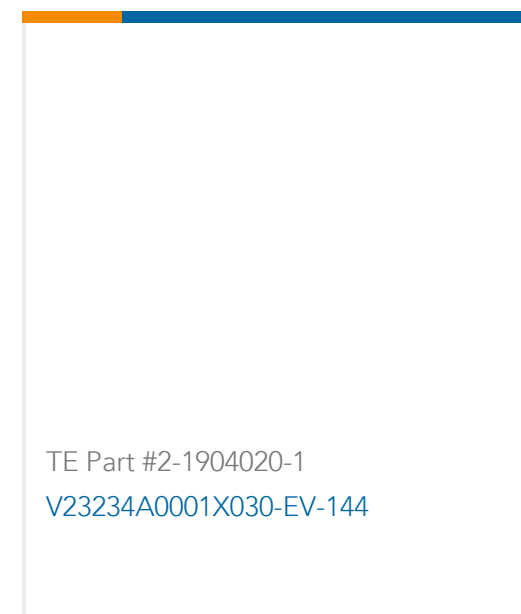
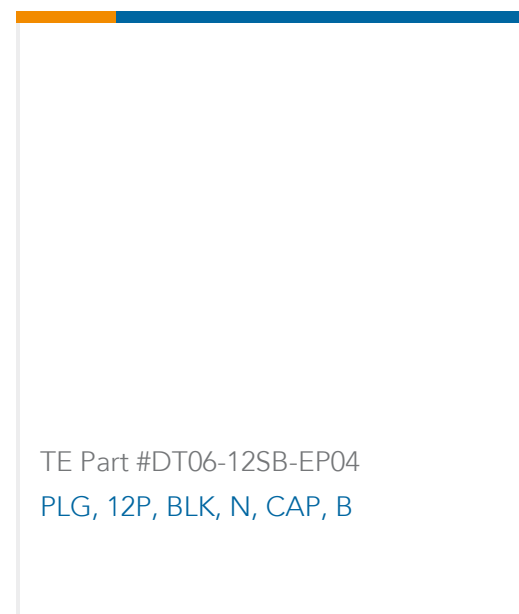
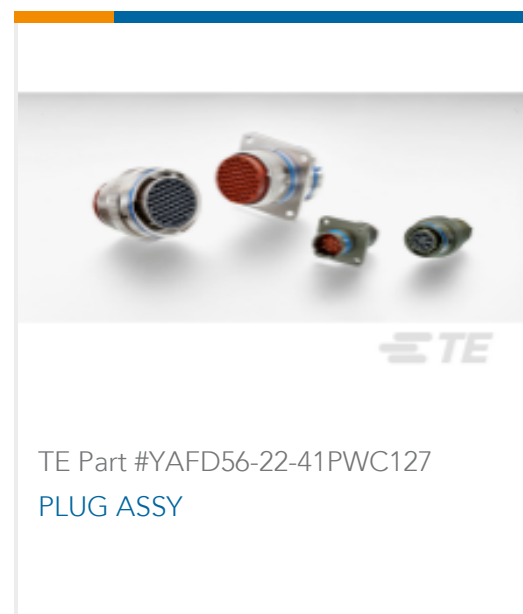
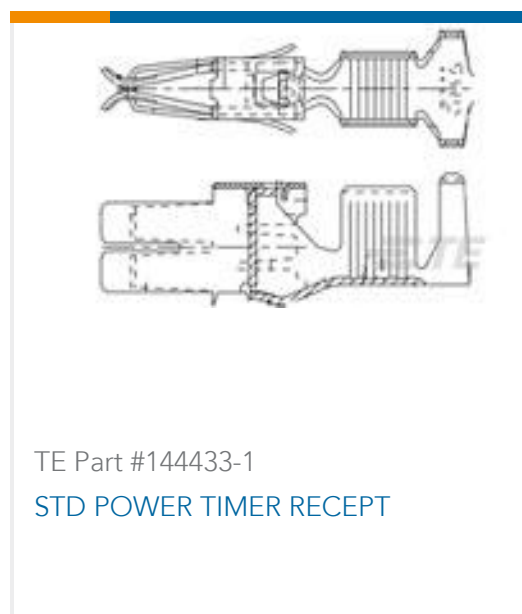

Documents

Product Drawings

VCF4-1001=CONNECTOR,HOUSING

English

CAD Files

Customer View Model

ENG_CVM_CVM_3-1393310-7_C.2d_dxf.zip

English

3D PDF

3D

Customer View Model

ENG_CVM_CVM_3-1393310-7_C.3d_igs.zip

English

Customer View Model

ENG_CVM_CVM_3-1393310-7_C.3d_stp.zip

English

By downloading the CAD file I accept and agree to the [Terms and Conditions](#) of use.

Datasheets & Catalog Pages

Automotive Relay Application Notes

English

Connectors for Mini ISO, Connectors Production Production North America, Accessories

English

Product Specifications

Definitions, Handling, Processing, Testing and Use of Relays

English

