

Double Side Cooled Module

FF400R07A01E3_S6

Final Data Sheet

V3.3, 2017-07-28

Automotive High Power

1 Features / Description

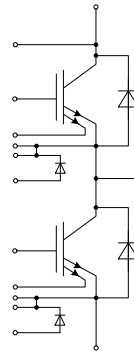
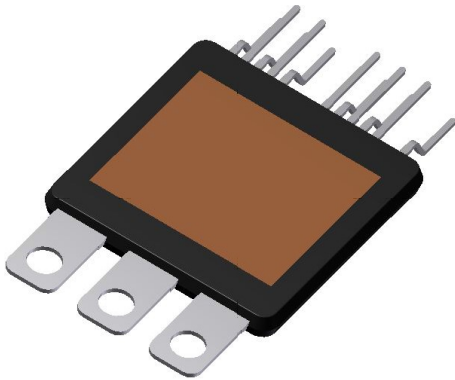

$V_{CES} = 700V$
 $I_{C\ nom} = 400A$

Typical Applications

- Automotive Applications
- Hybrid Electrical Vehicles (H)EV

Electrical Features

- Increased Blocking Voltage Capability to 700V
- Integrated Current Sensor
- Integrated Temperature Sensor
- Low Inductive Design
- Low Switching Losses
- $T_{vj\ op} = 150^{\circ}C$
- Short-time extended Operation Temperature
 $T_{vj\ op} = 175^{\circ}C$

Mechanical Features

- 2.5kV AC 1min Insulation
- Double sided cooling
- Compact design
- RoHS compliant

Description

The HybridPACK™ DSC S1 is a very compact half-bridge module targeting hybrid and electric vehicles.

The module is based on Infineon's long-term experience developing IGBT power modules and Trench-Field-Stop IGBTs including matching diodes with enhanced softness. Additionally, on-die integrated current sensor and temperature sensor allow precise monitoring of IGBT state. These features enable enhanced protection and intelligent control of the system.

The innovative and small package is designed for Double Sided Cooling (DSC) with superior thermal performance. The low stray inductance and increased blocking voltage support the design of systems with a very high efficiency. Furthermore, new material combinations and assembly technologies enable best thermal and electrical performance at highest reliability and mechanical robustness.

Product Name	Ordering Code
FF400R07A01E3_S6	SP001171964

2 IGBT, Inverter

2.1 Maximum Rated Values

Parameter	Conditions	Symbol	Value	Unit
Collector-emitter voltage	$T_{vj} = 25^{\circ}\text{C}$	V_{CES}	700	V
Continuous DC collector current	$T_C = 75^{\circ}\text{C}, T_{vj\text{ max}} = 175^{\circ}\text{C}$	$I_{C\text{ nom}}$	400	A
Repetitive peak collector current	$t_P = 1\text{ ms}$	I_{CRM}	800	A
Total power dissipation	$T_C = 25^{\circ}\text{C}, T_{vj\text{ max}} = 175^{\circ}\text{C}$	P_{tot}	1500	W
Gate-emitter peak voltage		V_{GES}	+/-20	V

2.2 Characteristic Values

Parameter	Conditions	Symbol	min. typ. max.			Unit	
Collector-emitter saturation voltage	$I_C = 400\text{ A}, V_{GE} = 15\text{ V}$ $I_C = 400\text{ A}, V_{GE} = 15\text{ V}$ $I_C = 400\text{ A}, V_{GE} = 15\text{ V}$	$T_{vj} = 25^{\circ}\text{C}$ $T_{vj} = 125^{\circ}\text{C}$ $T_{vj} = 150^{\circ}\text{C}$	$V_{CE\text{ sat}}$	1.65 1.90 2.00	2.30	V	
Gate threshold voltage	$I_C = 4.85\text{ mA}, V_{CE} = V_{GE}$	$T_{vj} = 25^{\circ}\text{C}$	$V_{GE\text{ th}}$	5.00	5.80	6.50	V
Gate charge	$V_{GE} = -15\text{ V} \dots 15\text{ V}$		Q_G	2.90		μC	
Internal gate resistor		$T_{vj} = 25^{\circ}\text{C}$	$R_{G\text{ int}}$	0.0		Ω	
Input capacitance	$f = 1\text{ MHz}, V_{CE} = 25\text{ V}, V_{GE} = 0\text{ V}$	$T_{vj} = 25^{\circ}\text{C}$	C_{ies}	18.0		nF	
Reverse transfer capacitance	$f = 1\text{ MHz}, V_{CE} = 25\text{ V}, V_{GE} = 0\text{ V}$	$T_{vj} = 25^{\circ}\text{C}$	C_{res}	0.50		nF	
Collector-emitter cut-off current	$V_{CE} = 450\text{ V}, V_{GE} = 0\text{ V}$	$T_{vj} = 25^{\circ}\text{C}$	I_{CES}		0.1	mA	
Gate-emitter leakage current	$V_{CE} = 0\text{ V}, V_{GE} = 20\text{ V}$	$T_{vj} = 25^{\circ}\text{C}$	I_{GES}		400	nA	
Turn-on delay time, inductive load	$I_C = 400\text{ A}, V_{CE} = 300\text{ V}$ $V_{GE} = -8/+15\text{ V}$ $R_{Gon} = 3.6\ \Omega$	$T_{vj} = 25^{\circ}\text{C}$ $T_{vj} = 125^{\circ}\text{C}$ $T_{vj} = 150^{\circ}\text{C}$	$t_{d\text{ on}}$	0.06 0.06 0.06		μs	
Rise time, inductive load	$I_C = 400\text{ A}, V_{CE} = 300\text{ V}$ $V_{GE} = -8/+15\text{ V}$ $R_{Gon} = 3.6\ \Omega$	$T_{vj} = 25^{\circ}\text{C}$ $T_{vj} = 125^{\circ}\text{C}$ $T_{vj} = 150^{\circ}\text{C}$	t_r	0.08 0.08 0.08		μs	
Turn-off delay time, inductive load	$I_C = 400\text{ A}, V_{CE} = 300\text{ V}$ $V_{GE} = -8/+15\text{ V}$ $R_{Goff} = 3.6\ \Omega$	$T_{vj} = 25^{\circ}\text{C}$ $T_{vj} = 125^{\circ}\text{C}$ $T_{vj} = 150^{\circ}\text{C}$	$t_{d\text{ off}}$	0.43 0.44 0.48		μs	
Fall time, inductive load	$I_C = 400\text{ A}, V_{CE} = 300\text{ V}$ $V_{GE} = -8/+15\text{ V}$ $R_{Goff} = 3.6\ \Omega$	$T_{vj} = 25^{\circ}\text{C}$ $T_{vj} = 125^{\circ}\text{C}$ $T_{vj} = 150^{\circ}\text{C}$	t_f	0.04 0.04 0.05		μs	
Turn-on energy loss per pulse	$I_C = 400\text{ A}, V_{CE} = 300\text{ V}, L_S = 25\text{ nH}$ $V_{GE} = -8/+15\text{ V}$ $R_{Gon} = 3.6\ \Omega$ $di/dt = 5.1\text{ kA}/\mu\text{s}$ ($T_{vj} = 150^{\circ}\text{C}$)	$T_{vj} = 25^{\circ}\text{C}$ $T_{vj} = 125^{\circ}\text{C}$ $T_{vj} = 150^{\circ}\text{C}$	E_{on}	5.70 7.40 7.90		mJ	
Turn-off energy loss per pulse	$I_C = 400\text{ A}, V_{CE} = 300\text{ V}, L_S = 25\text{ nH}$ $V_{GE} = -8/+15\text{ V}$ $R_{Goff} = 3.6\ \Omega$ $du/dt = 3.0\text{ kV}/\mu\text{s}$ ($T_{vj} = 150^{\circ}\text{C}$)	$T_{vj} = 25^{\circ}\text{C}$ $T_{vj} = 125^{\circ}\text{C}$ $T_{vj} = 150^{\circ}\text{C}$	E_{off}	14.5 16.5 18.0		mJ	
SC data	$V_{GE} \leq 15\text{ V}, V_{CC} = 360\text{ V}$ $V_{CE\text{ max}} = V_{CES} - L_{SCE} \cdot di/dt$ $t_P \leq 6\ \mu\text{s}, T_{vj} = 150^{\circ}\text{C}$		I_{SC}	1900		A	
Thermal resistance, junction to case	per IGBT		$R_{th\text{ JC}}$		0.100 ¹⁾	K/W	
Thermal resistance, case to heatsink	per IGBT $\lambda_{\text{Paste}} = 1\text{ W}/(\text{m}\cdot\text{K})$ / $\lambda_{\text{grease}} = 1\text{ W}/(\text{m}\cdot\text{K})$ Clamping Force $F = 700\text{ N}$		$R_{th\text{ CH}}$		0.140 ¹⁾	K/W	
Temperature under switching conditions	t_{op} continuous for 18s within a period of 600s, occurrence maximum 200 times over lifetime		$T_{vj\text{ op}}$	-40 150	150 175	$^{\circ}\text{C}$	

¹⁾ with double sided cooling, evaluation according to HybridPack™ DSC application note

3 Diode, Inverter

3.1 Maximum Rated Values

Parameter	Conditions	Symbol	Value	Unit
Repetitive peak reverse voltage	$T_{vj} = 25^{\circ}\text{C}$	V_{RRM}	700	V
Continuous DC forward current		I_F	400	A
Repetitive peak forward current	$t_P = 1 \text{ ms}$	I_{FRM}	800	A
I^2t - value	$V_R = 0 \text{ V}$, $t_P = 10 \text{ ms}$, $T_{vj} = 125^{\circ}\text{C}$	I^2t	9000	A^2s

3.2 Characteristic Values

Parameter	Conditions	Symbol	min. typ. max.			Unit
Forward voltage	$I_F = 400 \text{ A}$, $V_{GE} = 0 \text{ V}$ $I_F = 400 \text{ A}$, $V_{GE} = 0 \text{ V}$ $I_F = 400 \text{ A}$, $V_{GE} = 0 \text{ V}$	$T_{vj} = 25^{\circ}\text{C}$ $T_{vj} = 125^{\circ}\text{C}$ $T_{vj} = 150^{\circ}\text{C}$	V_F	1.95 1.85 1.80	2.55	V
Peak reverse recovery current	$I_F = 400 \text{ A}$, $-di_F/dt = 5000 \text{ A}/\mu\text{s}$ ($T_{vj} = 150^{\circ}\text{C}$) $V_R = 300 \text{ V}$ $V_{GE} = -8 \text{ V}$	$T_{vj} = 25^{\circ}\text{C}$ $T_{vj} = 125^{\circ}\text{C}$ $T_{vj} = 150^{\circ}\text{C}$	I_{RM}	135 210 220		A
Recovered charge	$I_F = 400 \text{ A}$, $-di_F/dt = 5000 \text{ A}/\mu\text{s}$ ($T_{vj} = 150^{\circ}\text{C}$) $V_R = 300 \text{ V}$ $V_{GE} = -8 \text{ V}$	$T_{vj} = 25^{\circ}\text{C}$ $T_{vj} = 125^{\circ}\text{C}$ $T_{vj} = 150^{\circ}\text{C}$	Q_r	12.0 23.0 27.0		μC
Reverse recovery energy	$I_F = 400 \text{ A}$, $-di_F/dt = 5000 \text{ A}/\mu\text{s}$ ($T_{vj} = 150^{\circ}\text{C}$) $V_R = 300 \text{ V}$ $V_{GE} = -8 \text{ V}$	$T_{vj} = 25^{\circ}\text{C}$ $T_{vj} = 125^{\circ}\text{C}$ $T_{vj} = 150^{\circ}\text{C}$	E_{rec}	2.80 5.80 6.60		mJ
Thermal resistance, junction to case	per diode	R_{thJC}			0.150 ¹⁾	K/W
Thermal resistance, case to heatsink	per diode $\lambda_{Paste} = 1 \text{ W}/(\text{m}\cdot\text{K})$ / $\lambda_{grease} = 1 \text{ W}/(\text{m}\cdot\text{K})$ Clamping Force $F = 700\text{N}$	R_{thCH}		0.200 ¹⁾		K/W
Temperature under switching conditions	t_{op} continuous for 18s within a period of 600s, occurrence maximum 200 times over lifetime	$T_{vj op}$	-40 150		150 175	$^{\circ}\text{C}$

4 Module

Parameter	Conditions	Symbol	Value	Unit	
Isolation test voltage	RMS, $f = 50 \text{ Hz}$, $t = 1 \text{ min.}$	V_{ISOL}	2.5	kV	
Material of module baseplate			Cu		
Internal isolation	basic insulation (class 1, IEC 61140)		Al_2O_3		
Creepage distance	terminal to heatsink terminal to terminal	d_{Creep}	3.5	mm	
Clearance	terminal to heatsink terminal to terminal	d_{Clear}	3.5	mm	
Comperative tracking index		CTI	> 600		
			min. typ. max.		
Stray inductance module		L_{sCE}	15	nH	
Storage temperature		T_{stg}	-40	125	$^{\circ}\text{C}$
Terminal connection torque	Screw M5	M	-		Nm
Mounting force per clamp		F	-	900	N
Weight		G	30		g

5 Temperature Sensor

Parameter	Conditions	Symbol	Min	Typ	Max	Unit
Forward voltage	$I_{TS} = 1.00 \text{ mA}$, $T_{vj} = 150^{\circ}\text{C}$ $I_{TS} = 1.00 \text{ mA}$, $T_{vj} = 25^{\circ}\text{C}$	V_{TS}		2.12 2.91		V

¹⁾ with double sided cooling, evaluation according to HybridPack™ DSC application note

6 Current Sensor

Parameter	Conditions	Symbol	Min	Typ	Max	Unit
Output voltage	$V_{CE} = 2.35 \text{ V}$, $I_C = 800 \text{ A}$ $R_{\text{sense}} = 1.60 \text{ } \Omega$, $T_{vj} = 25^\circ\text{C}$ $V_{GE} = 15 \text{ V}$	V_{sense}		0.64		V

7 Characteristics Diagrams

output characteristic IGBT, Inverter (typical)

$I_C = f(V_{CE})$
 $V_{GE} = 15\text{ V}$

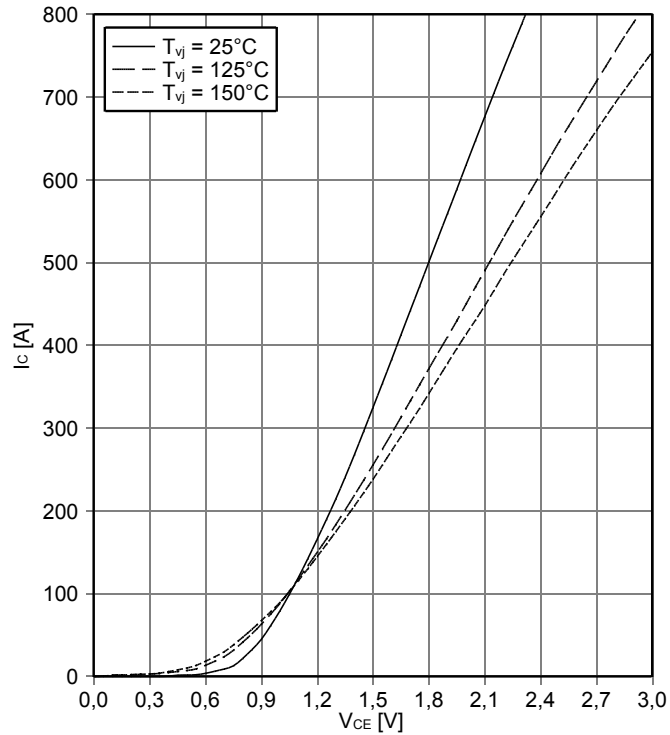

output characteristic IGBT, Inverter (typical)

$I_C = f(V_{CE})$
 $T_{vj} = 150^\circ\text{C}$

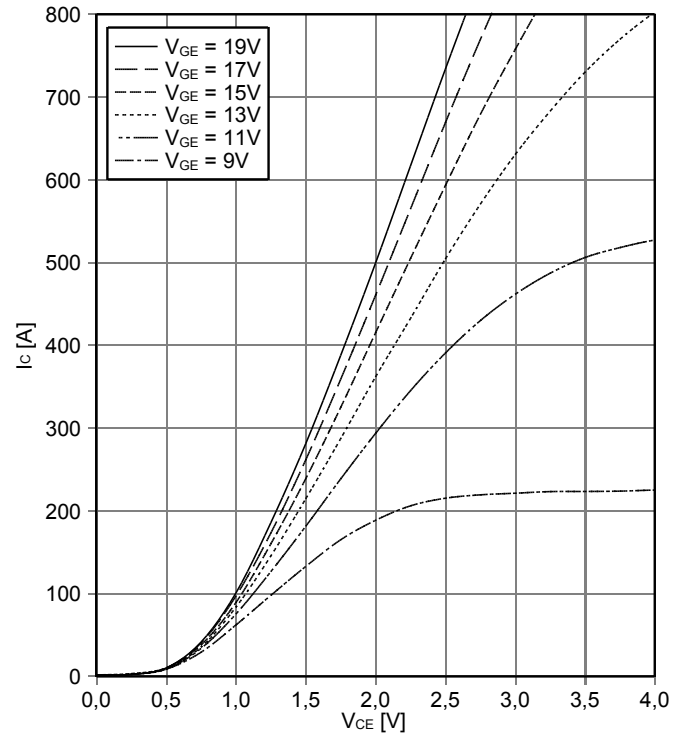

transfer characteristic IGBT, Inverter (typical)

$I_C = f(V_{GE})$
 $V_{CE} = 20\text{ V}$

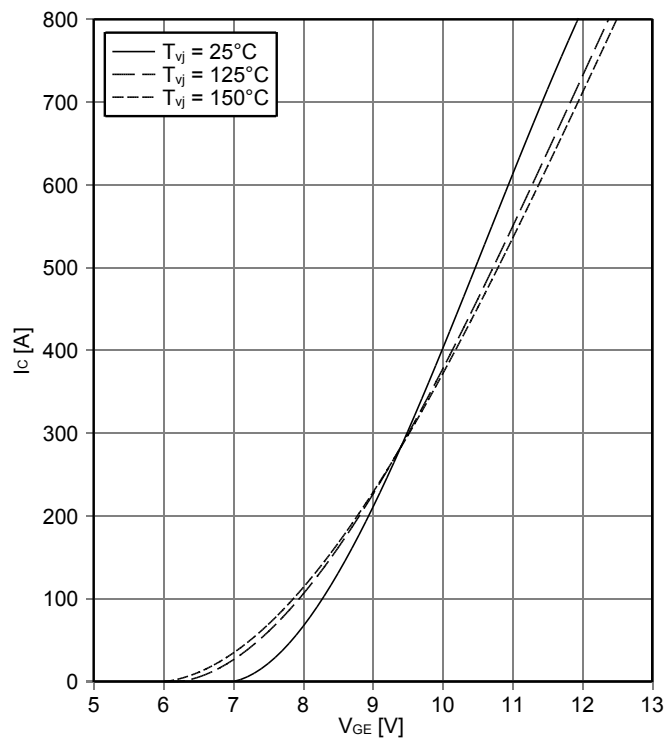

switching losses IGBT, Inverter (typical)

$E_{on} = f(I_C)$, $E_{off} = f(I_C)$
 $V_{GE} = -8 / +15\text{ V}$, $R_{Gon} = 3.6\ \Omega$, $R_{Goff} = 3.6\ \Omega$, $V_{CE} = 300\text{ V}$

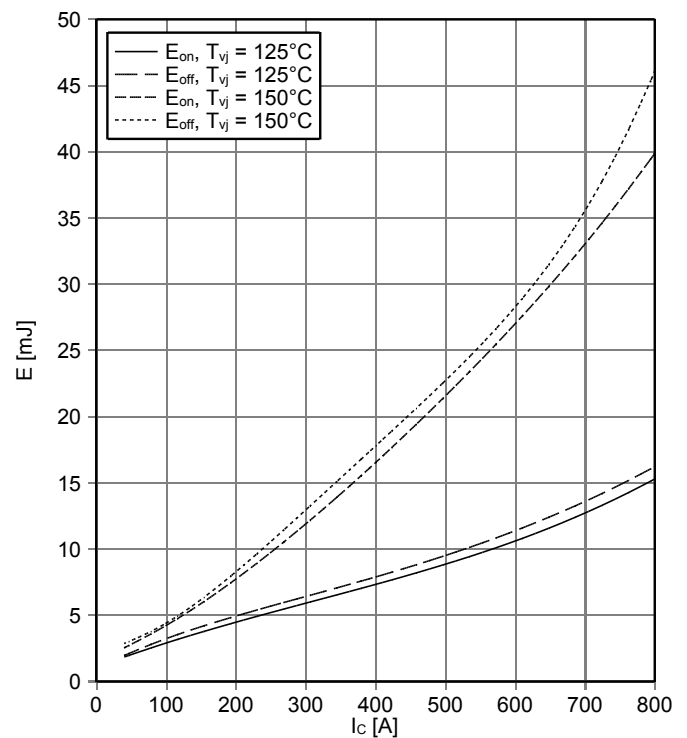

switching losses IGBT, Inverter (typical)

$$E_{on} = f(R_G), E_{off} = f(R_G)$$

$V_{GE} = -8 / +15 \text{ V}, I_C = 400 \text{ A}, V_{CE} = 300 \text{ V}$

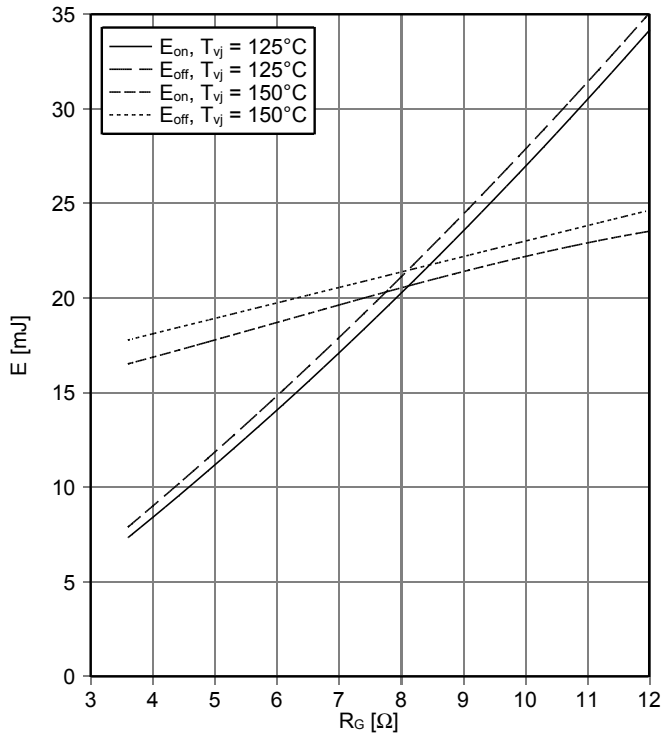

transient thermal impedance IGBT, Inverter

$$Z_{thJH} = f(t)$$

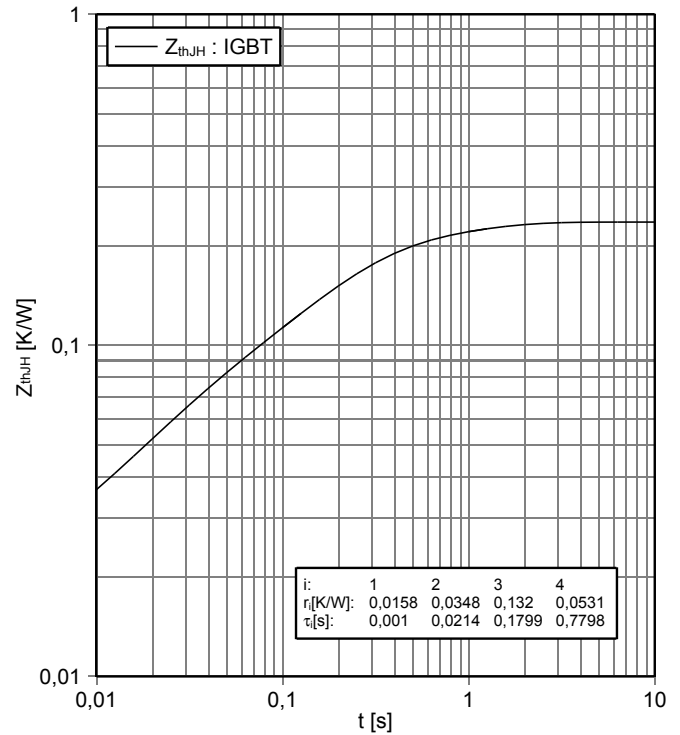

reverse bias safe operating area IGBT, Inverter (RBSOA)

$$I_C = f(V_{CE})$$

$V_{GE} = \pm 15 \text{ V}, R_{Goff} = 3.6 \Omega, T_{vj} = 150^\circ\text{C}$

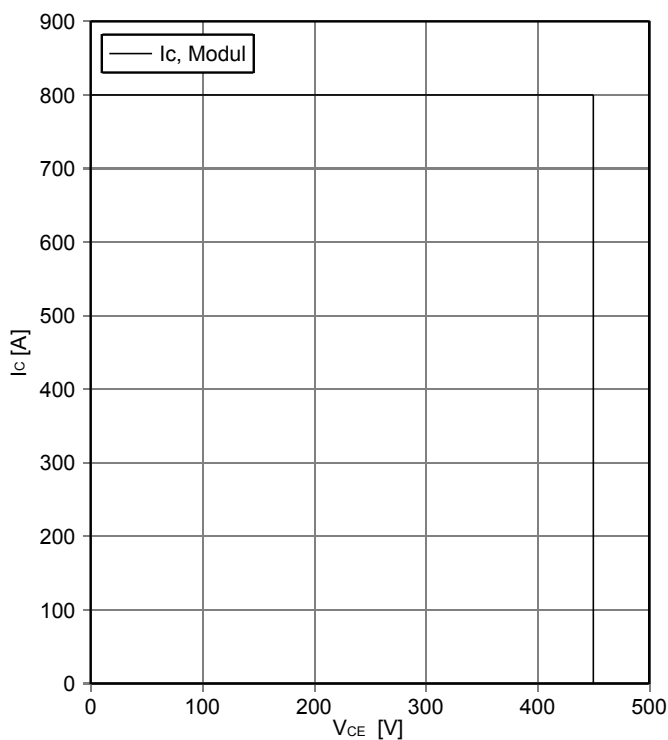

forward characteristic of Diode, Inverter (typical)

$$I_F = f(V_F)$$

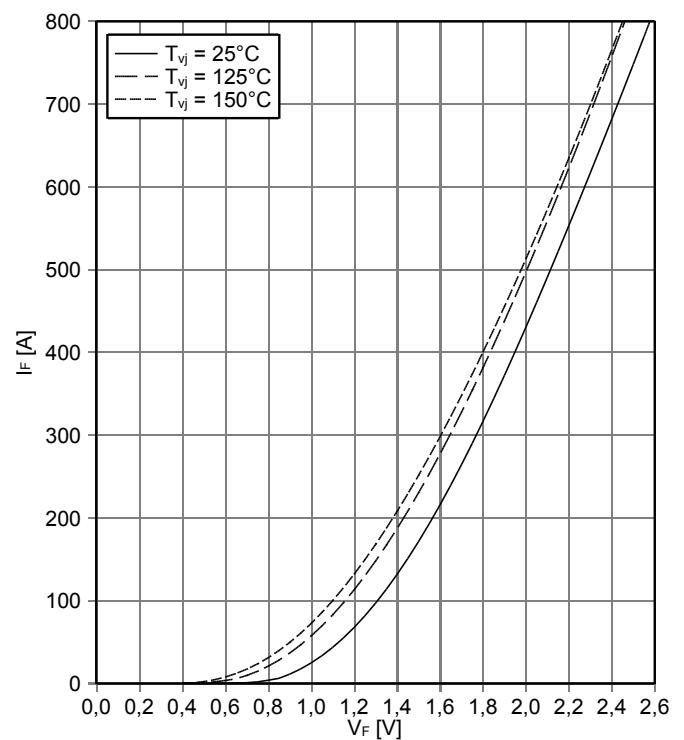

switching losses Diode, Inverter (typical)

$E_{rec} = f(I_F)$
 $R_{Gon} = 3.6 \Omega, V_{CE} = 300 V$

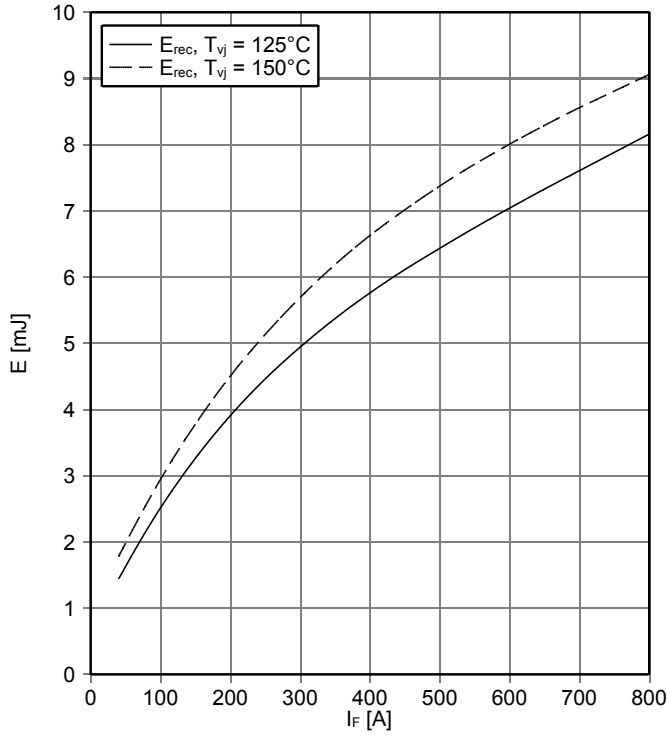

switching losses Diode, Inverter (typical)

$E_{rec} = f(R_G)$
 $I_F = 400 A, V_{CE} = 300 V$

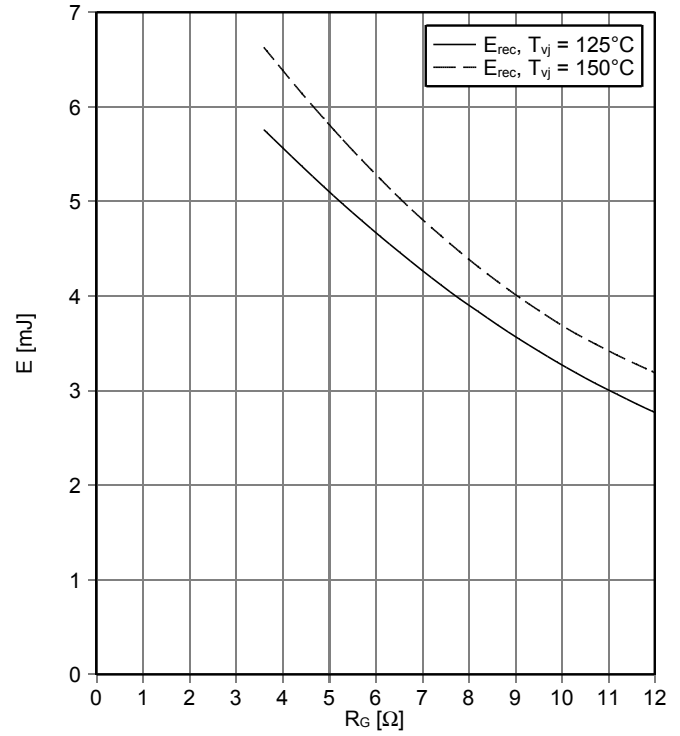

transient thermal impedance Diode, Inverter

$Z_{thJH} = f(t)$

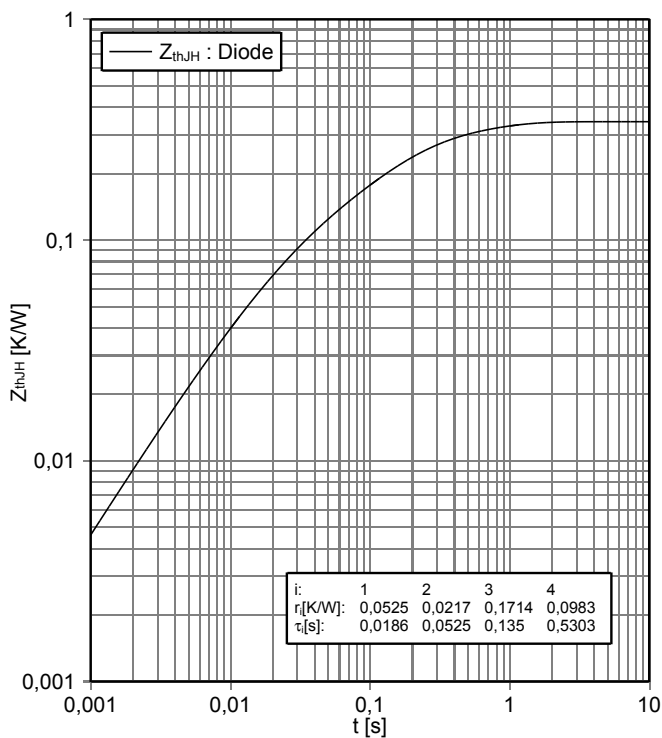

8 Circuit diagram

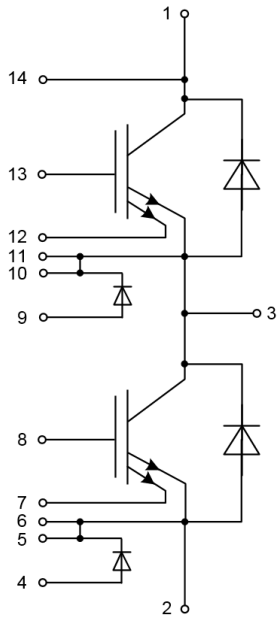

Pin Number	Symbol	I/O	Function
1	P	DC Supply (+)	Positive Supply
2	N	DC Supply (-)	Negative Supply
3	U	AC Output	U Phase Output
4	T+L	Input	Temperature Sensor Plus Low Side
5	T-L	Output	Temperature Sensor Minus Low Side
6	EL	Output	IGBT Emitter Output Low Side
7	CSL	Output	IGBT Current Sensor Output Low Side
8	GL	Input	Gate Input Low Side
9	T+H	Input	Temperature Sensor Plus High Side
10	T-H	Output	Temperature Sensor Minus High Side
11	EH	Output	IGBT Emitter Output High Side
12	CSH	Output	IGBT Current Sensor output High Side
13	GH	Input	Gate Input High Side
14	PS	Output	P-Terminal Voltage Sensing / IGBT Collector Output

9 Package outlines

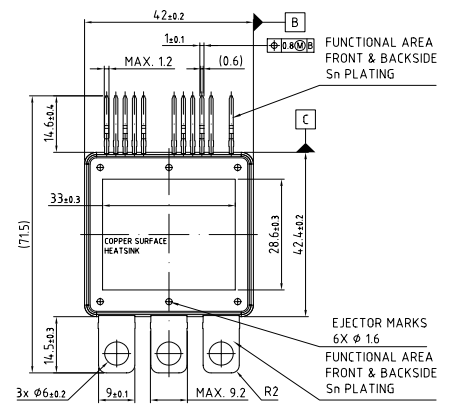
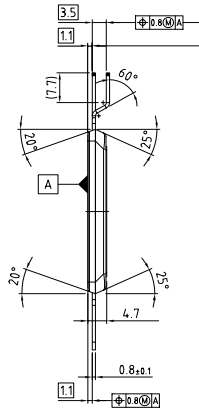
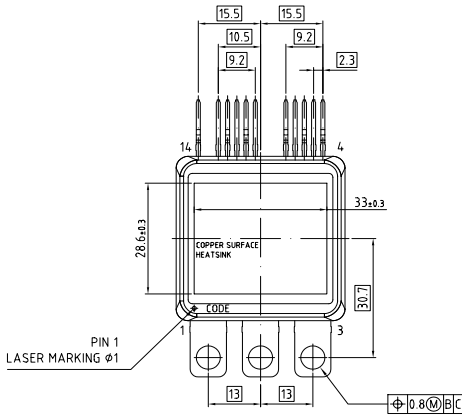

Drawing: Z8B00172542 POL 000 06	Drawing according to ISO 8015	General tolerances: ISO 2768-mH
------------------------------------	----------------------------------	------------------------------------

10 Label Codes

10.1 Module Code

Code Format	Data Matrix		
Encoding	ASCII Text		
Symbol Size	16x16		
Standard	IEC24720 and IEC16022		
Code Content	Content Module Serial Number Module Material Number Production Order Number Datecode (Production Year) Datecode (Production Week)	Digit 1 - 5 6 - 11 12 - 19 20 - 21 22 - 23	Example (below) 71549 142846 55054991 15 30
Example	 71549142846550549911530		

10.2 Packing Code

Code Format	Code128			
Encoding	Code Set A			
Symbol Size	34 digits			
Standard	IEC8859-1			
Code Content	Content Backend Construction Number Production Lot Number Serial Number Date Code Box Quantity	Identifier X 1T S 9D Q	Digit 2 - 9 12 - 19 21 - 25 28 - 31 33 - 34	Example (below) 95056609 2X0003E0 754389 1139 15
Example	 X950566091T2X0003E0S754389D1139Q15			

Revision History

Major changes since previous revision

Revision History

Reference	Date	Description
V1.0	2015-03-26	Initial Version
V1.1	2015-04-07	Extension of target data
V2.0	2016-02-02	Update of target data
V3.0	2016-11-07	Final Datasheet
V3.1	2016-11-08	Change of product name in description
V3.2	2016-12-13	Changes in description
V3.3	2017-07-28	Update mechanical drawing

Terms & Conditions of usage

Edition 2014-05-30

Published by
Infineon Technologies AG
81726 Munich, Germany
 © 2014 Infineon Technologies AG
All Rights Reserved.

Legal Disclaimer

The information given in this document shall in no event be regarded as a guarantee of conditions or characteristics. With respect to any examples or hints given herein, any typical values stated herein and/or any information regarding the application of the device, Infineon Technologies hereby disclaims any and all warranties and liabilities of any kind, including without limitation, warranties of non-infringement of intellectual property rights of any third party.

Information

For further information on technology, delivery terms and conditions and prices, please contact the nearest Infineon Technologies Office (<http://www.infineon.com>)

Warnings

Due to technical requirements, components may contain dangerous substances. For information on the types in question, please contact the nearest Infineon Technologies Office.

Infineon Technologies components may be used in life-support devices or systems only with the express written approval of Infineon Technologies, if a failure of such components can reasonably be expected to cause the failure of that life-support device or system or to affect the safety or effectiveness of that device or system. Life support devices or systems are intended to be implanted in the human body or to support and/or maintain and sustain and/or protect human life. If they fail, it is reasonable to assume that the health of the user or other persons may be endangered.

Trademarks

Trademarks of Infineon Technologies AG

AURIX™, C166™, CanPAK™, CIPOS™, CIPURSE™, EconoPACK™, CoolMOS™, CoolSET™, CORECONTROL™, CROSSAVE™, DAVE™, DI-POL™, EasyPIM™, EconoBRIDGE™, EconoDUAL™, EconoPIM™, EconoPACK™, EiceDRIVER™, eupec™, FCOS™, HITFET™, HybridPACK™, I²RF™, ISOFACE™, IsoPACK™, MIPAQ™, ModSTACK™, my-d™, NovalithIC™, OptiMOS™, ORIGA™, POWERCODE™, PRIMARION™, PrimePACK™, PrimeSTACK™, PRO-SIL™, PROFET™, RASIC™, ReverSave™, SatRIC™, SIEGET™, SINDRION™, SIPMOS™, SmartLEWIS™, SOLID FLASH™, TEMPFET™, thinQ!™, TRENCHSTOP™, TriCore™.

Other Trademarks

Advance Design System™ (ADS) of Agilent Technologies, AMBA™, ARM™, MULTI-ICE™, KEIL™, PRIMECELL™, REALVIEW™, THUMB™, μVision™ of ARM Limited, UK. AUTOSAR™ is licensed by AUTOSAR development partnership. Bluetooth™ of Bluetooth SIG Inc. CAT-iq™ of DECT Forum. COLOSSUS™, FirstGPS™ of Trimble Navigation Ltd. EMV™ of EMVCo, LLC (Visa Holdings Inc.). EPCOS™ of Epcos AG. FLEXGO™ of Microsoft Corporation. FlexRay™ is licensed by FlexRay Consortium. HYPERTERMINAL™ of Hilgraeve Incorporated. IEC™ of Commission Electrotechnique Internationale. IrDA™ of Infrared Data Association Corporation. ISO™ of INTERNATIONAL ORGANIZATION FOR STANDARDIZATION. MATLAB™ of MathWorks, Inc. MAXIM™ of Maxim Integrated Products, Inc. MICROTEC™, NUCLEUS™ of Mentor Graphics Corporation. MIPI™ of MIPI Alliance, Inc. MIPS™ of MIPS Technologies, Inc., USA. muRata™ of MURATA MANUFACTURING CO., MICROWAVE OFFICE™ (MWO) of Applied Wave Research Inc., OmniVision™ of OmniVision Technologies, Inc. Openwave™ Openwave Systems Inc. RED HAT™ Red Hat, Inc. RFMD™ RF Micro Devices, Inc. SIRIUS™ of Sirius Satellite Radio Inc. SOLARIS™ of Sun Microsystems, Inc. SPANSION™ of Spansion LLC Ltd. Symbian™ of Symbian Software Limited. TAIYO YUDEN™ of Taiyo Yuden Co. TEAKLITE™ of CEVA, Inc. TEKTRONIX™ of Tektronix Inc. TOKO™ of TOKO KABUSHIKI KAISHA TA. UNIX™ of X/Open Company Limited. VERILOG™, PALLADIUM™ of Cadence Design Systems, Inc. VLYNQ™ of Texas Instruments Incorporated. VXWORKS™, WIND RIVER™ of WIND RIVER SYSTEMS, INC. ZETEX™ of Diodes Zetex Limited.

Last update

2011-11-11

www.infineon.com