

# RL8 Low ESR, Low Profile (φ8)

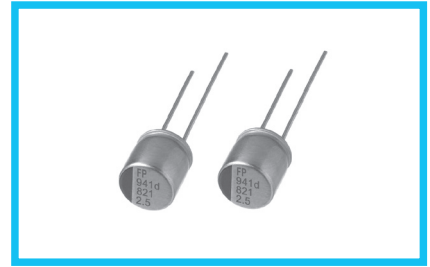

## FPCAP



- Ultra Low ESR, High ripple current.
- Low Profile (Height 8mm).
- Load life of 2000/5000 hours at 105°C.
- Radial lead type : Lead free flow soldering condition correspondence.
- Compliant to the RoHS directive (2011/65/EU).

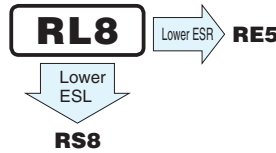

### Specifications

Item	Performance Characteristics	
Category Temperature Range	-55 to +105°C	
Rated Voltage Range	2.5 to 35V	
Rated Capacitance Range	100 to 1500μF	
Capacitance Tolerance	±20% at 120Hz, 20°C	
Tangent of loss angle (tan δ)	Less than or equal to the specified value at 120Hz, 20°C	
ESR (※1)	Less than or equal to the specified value at 100kHz, 20°C	
Leakage Current (※2)	Less than or equal to the specified value. After 2 minutes' application of rated voltage at 20°C	
Endurance	Test condition	105°C, rated voltage 2000 / 5000Hrs.
	Capacitance change	Within ±20% of initial value before test
	tan δ	150% or less than the initial specified value
	ESR(※1)	150% or less than the initial specified value
	Leakage current (※2)	Less than or equal to the initial specified value

※1 ESR should be measured at both of the terminal ends closest to the capacitor body.

※2 Conditioning : If any doubt arises, measure the leakage current after the voltage treatment of applying DC rated voltage continuously to the capacitor for 120 minutes at 105°C.

### Dimensions

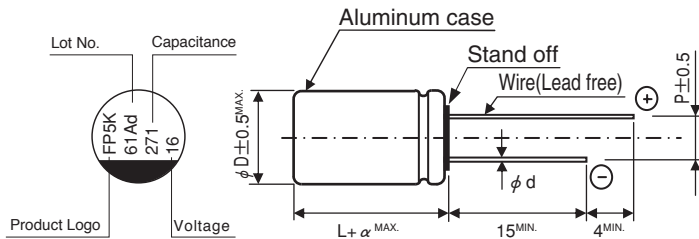

(mm)			
φD×L	φd	P	α
8×8	0.6	3.5	1.0

### Frequency coefficient of rated ripple current

Frequency	120 Hz	1 kHz	10 kHz	100 kHz	300 kHz
Coefficient	0.10	0.45	0.50	1.00	1.00

### Type numbering system (Example : 16V 270μF) Nichicon part number

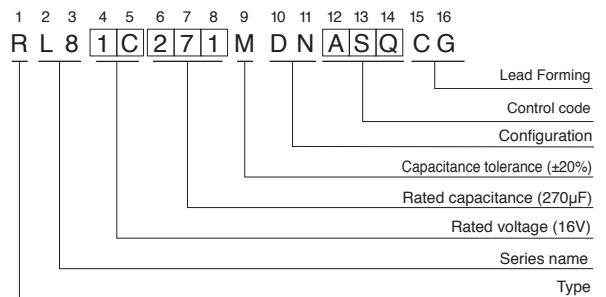

### FPCAP part number

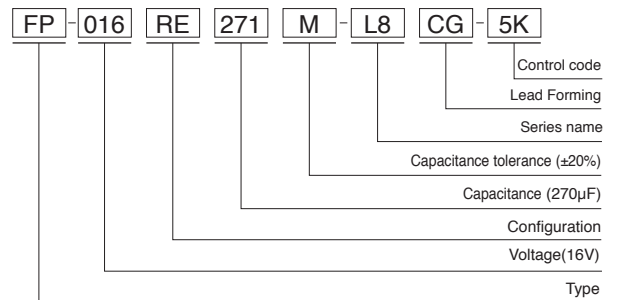

# RL8

## Standard Ratings

Rated Voltage (V) (code)	Surge Voltage (V)	Rated Capacitance (μF)	Case Size φD×L (mm)	tan δ	Leakage Current (μA, 2min.)	ESR (mΩ) (20°C/100kHz)	Rated Ripple Current (mA rms) (105°C/100kHz)	NICHICON	FPCAP
2.5 (0E)	2.8	560	8×8	0.12	500	6	6100	RL80E561MDN1□□	FP-2R5RE561M-L8□□
		※560	8×8	0.12	500	6	6100	RL80E561MDNASQ□□	FP-2R5RE561M-L8□□-5K
		820	8×8	0.12	513	6	6100	RL80E821MDN1□□	FP-2R5RE821M-L8□□
		※820	8×8	0.12	513	6	6100	RL80E821MDNASQ□□	FP-2R5RE821M-L8□□-5K
		1000	8×8	0.12	625	6	6100	RL80E102MDN1□□	FP-2R5RE102M-L8□□
		1200	8×8	0.12	750	7	6100	RL80E122MDN1□□	FP-2R5RE122M-L8□□
		1500	8×8	0.12	938	7	6100	RL80E152MDN1□□	FP-2R5RE152M-L8□□
4.0 (0G)	4.6	560	8×8	0.12	560	6	6100	RL80G561MDN1□□	FP-4R0RE561M-L8□□
		※560	8×8	0.12	560	6	6100	RL80G561MDNASQ□□	FP-4R0RE561M-L8□□-5K
		820	8×8	0.12	820	6	6100	RL80G821MDN1□□	FP-4R0RE821M-L8□□
6.3 (0J)	7.2	470	8×8	0.12	592	8	5700	RL80J471MDN1□□	FP-6R3RE471M-L8□□
		※470	8×8	0.12	592	8	5700	RL80J471MDNASQ□□	FP-6R3RE471M-L8□□-5K
		560	8×8	0.12	706	8	5700	RL80J561MDN1□□	FP-6R3RE561M-L8□□
		※560	8×8	0.12	706	8	5700	RL80J561MDNASQ□□	FP-6R3RE561M-L8□□-5K
		680	8×8	0.12	857	8	5700	RL80J681MDN1□□	FP-6R3RE681M-L8□□
		820	8×8	0.12	1033	8	5700	RL80J821MDN1□□	FP-6R3RE821M-L8□□
		1000	8×8	0.12	1260	9	5700	RL80J102MDN1□□	FP-6R3RE102M-L8□□
16 (1C)	18.4	100	8×8	0.12	320	12	5000	RL81C101MDN1□□	FP-016RE101M-L8□□
		180	8×8	0.12	576	12	5000	RL81C181MDN1□□	FP-016RE181M-L8□□
		220	8×8	0.12	704	12	5000	RL81C221MDN1□□	FP-016RE221M-L8□□
		270	8×8	0.12	864	10	5000	RL81C271MDN1□□	FP-016RE271M-L8□□
		※270	8×8	0.12	864	10	5000	RL81C271MDNASQ□□	FP-016RE271M-L8□□-5K
		330	8×8	0.12	1056	12	5000	RL81C331MDN1□□	FP-016RE331M-L8□□
35 (1V)	40.2	100	8×8	0.12	700	25	3000	RL81V101MDN1□□	FP-035RE101M-L8□□

※ : Load life 5000hours.

## Frequency Characteristics (The frequency characteristics are typical and not a guaranteed value.)

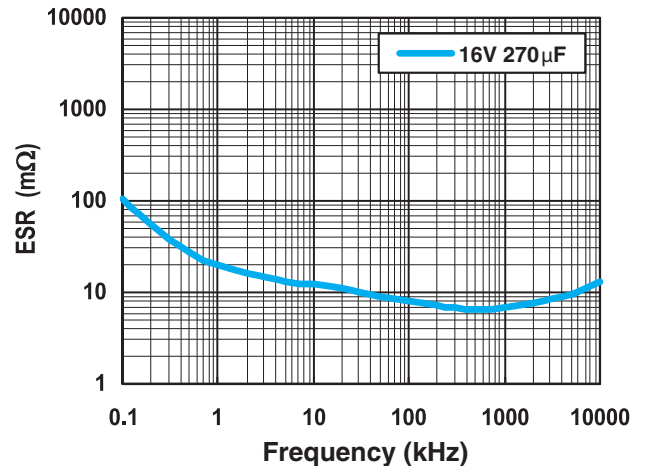
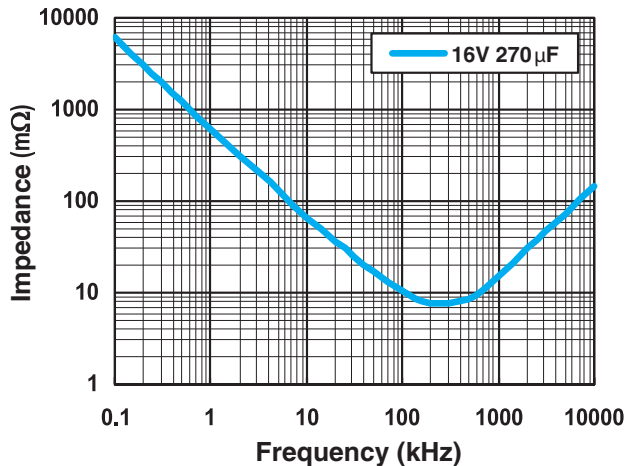

- Taping specifications are given in page 26, 27.
- Please refer to page 3 for the minimum order quantity.

# Mouser Electronics

Authorized Distributor

Click to View Pricing, Inventory, Delivery & Lifecycle Information:

## Nichicon:

[RL81C331MDN1KX](#) [RL81V101MDN1KX](#) [RL80J471MDNASQ](#) [RL80J681MDN1](#) [RL81C271MDN1](#) [RL80J821MDN1](#)  
[RL80E561MDN1](#) [RL80E102MDN1](#) [RL80G821MDN1](#) [RL80E821MDNASQ](#) [RL80E152MDN1](#) [RL81C221MDN1](#)  
[RL80E821MDN1](#) [RL80E122MDN1](#) [RL81C181MDN1](#) [RL80J561MDNASQ](#) [RL80G561MDN1](#) [RL80E561MDNASQ](#)  
[RL80J471MDN1](#) [RL80G561MDNASQ](#) [RL80J102MDN1](#) [RL80J561MDN1](#) [RL80E561MDNASQKX](#)  
[RL80J471MDNASQPX](#) [RL81C271MDN1KX](#) [RL80J561MDNASQKX](#) [RL81C271MDN1PX](#) [RL80J471MDNASQKX](#)  
[RL80E152MDN1KX](#) [RL80J821MDN1PX](#) [RL81C221MDN1KX](#) [RL80E122MDN1KX](#) [RL80E821MDNASQKX](#)  
[RL80J821MDN1KX](#) [RL81C181MDN1PX](#) [RL80G561MDNASQKX](#) [RL80E561MDN1KX](#) [RL80J471MDN1KX](#)  
[RL80G821MDN1KX](#) [RL81C221MDN1PX](#) [RL80J471MDN1PX](#) [RL80J681MDN1KX](#) [RL80G561MDN1KX](#)  
[RL80J561MDN1KX](#) [RL80J681MDN1PX](#) [RL80E102MDN1KX](#) [RL81C181MDN1KX](#) [RL80E821MDN1KX](#)  
[RL81V101MDN1](#) [RL80J821MDNASQ](#) [RL80J102MDN1KX](#) [RL81C101MDN1KX](#) [RL81C331MDN1](#)