

Data sheet | Item number: 2200-1201

2-conductor through terminal block; with push-button; 1 mm²; with test port; side and center marking; for DIN-rail 35 x 15 and 35 x 7.5; Push-in CAGE CLAMP®; 1,00 mm²; gray

www.wago.com/2200-1201

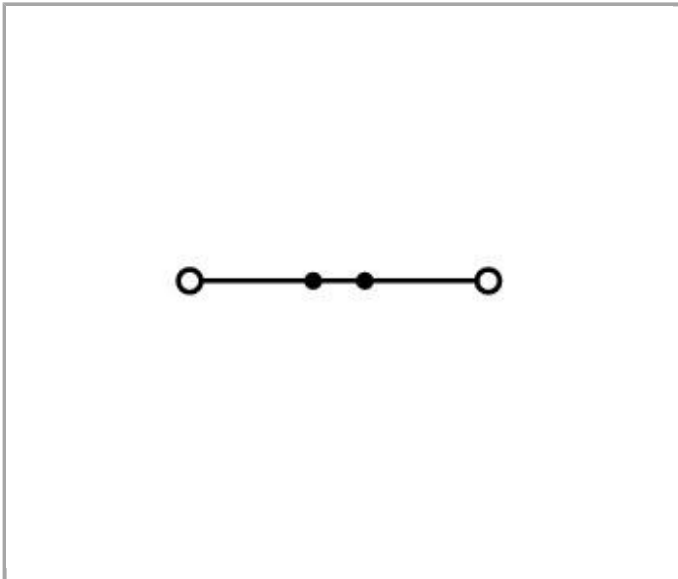
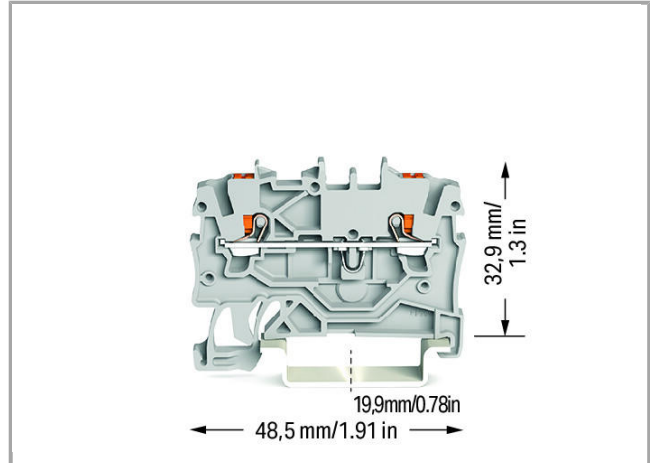
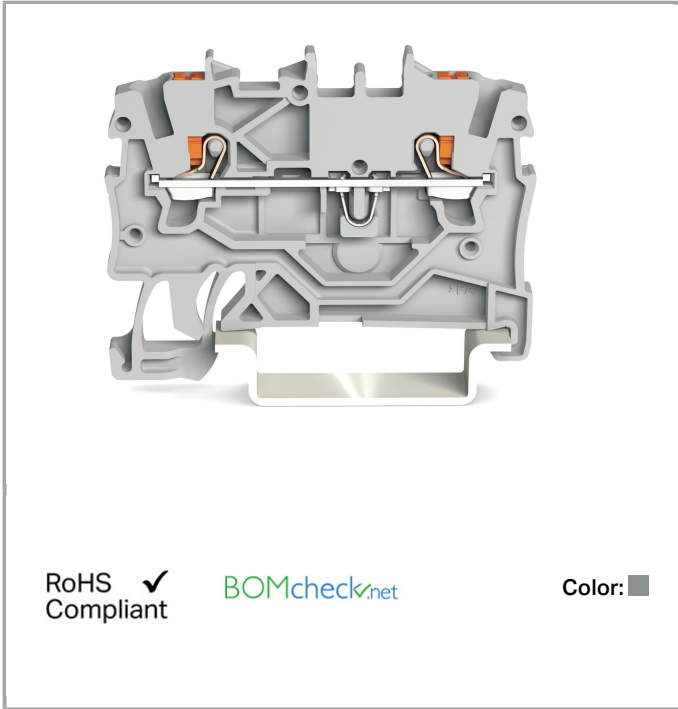

Data
Electrical data

Ratings per IEC/EN 60664-1

Rated voltage (III / 3)	800 V
Rated impulse voltage (III / 3)	8 kV
Rated current	13.5 A
Rated current (2)	18 A

Approvals per UL 1059

Rated voltage UL (Use Group B)	600 V
Rated current UL (Use Group B)	10 A
Rated voltage UL (Use Group C)	600 V
Rated current UL (Use Group C)	10 A

Connection data

Connection technology	Push-in CAGE CLAMP®
Actuation type	Push-in Push-button
Connectable conductor materials	Copper
Nominal cross section	1 mm ²
Solid conductor	0.14 ... 1.5 mm ² / 24 ... 16 AWG
Solid conductor, push-in termination	0.5 ... 1.5 mm ² / 20 ... 16 AWG
Fine-stranded conductor	0.14 ... 1.5 mm ² / 24 ... 16 AWG
Strip length	9 ... 11 mm / 0.35 ... 0.43 inch
Note (conductor cross-section)	Depending on the conductor characteristic, a conductor with a smaller cross section can also be inserted via push-in termination.
Total number of connection points	2
Total number of potentials	1
Number of levels	1
Type of wiring	Front-entry wiring
Number of jumper slots	2

Geometrical Data

Width	3.5 mm / 0.138 inch
Height from upper-edge of DIN-35 rail	32.9 mm / 1.295 inch
Depth	48.5 mm / 1.909 inch

Mechanical data

Design	horizontal
Type of mounting	DIN-35 rail
Marking level	Center/side marking

Material Data



Color	gray
Insulating material	Polyamide 66 (PA 66)
Weight	3.504 g

Commercial data



Country of origin	DE
GTIN	4055143691543
Customs Tariff No.	85369010000

Approvals / Certificates

Ex-Approvals

Logo	Approval	Additional Approval Text	Certificate name
	AEx Underwriters Laboratories Inc.	UL 60079	4788311594
	ATEX Physikalisch Technische Bundesanstalt	IEC 60079-0	PTB 18 ATEX 1003 U
	IECEX Physikalisch Technische Bundesanstalt	IEC 60079	IECEX PTB 18.0010U (Ex eb IIC Gb and Ex eb I Mb)

Country specific Approvals

Logo	Approval	Additional Approval Text	Certificate name
	CCA DEKRA Certification B.V.	EN 60947	NTR NL 7663
	CSA DEKRA Certification B.V.	C22.2	70173737
	KEMA/KEUR DEKRA Certification B.V.	IEC 60947	71- 102874





Ship Approvals

















Logo	Approval	Additional Approval Text	Certificate name
	ABS American Bureau of Shipping	-	19- HG1866350- PDA
	DNV GL Det Norske Veritas, Germanischer Lloyd	-	TAE00003JT
	LR Lloyds Register	-	19/20050



















UL-Approvals

Logo	Approval	Additional Approval Text	Certificate name
	cURus Underwriters Laboratories Inc.	UL 1059	4788311592

Compatible products

ferrule			
	Item no.: 216-241 Ferrule; Sleeve for 0.5 mm ² / 20 AWG; insulated; electro-tin plated; electrolytic copper; gastight crimped; acc. to DIN 46228, Part 4/09.90; white	www.wago.com/216-241	
	Item no.: 216-242 Ferrule; Sleeve for 0.75 mm ² / 18 AWG; insulated; electro-tin plated; electrolytic copper; gastight crimped; acc. to DIN 46228, Part 4/09.90; gray	www.wago.com/216-242	
	Item no.: 216-243 Ferrule; Sleeve for 1 mm ² / AWG 18; insulated; electro-tin plated; electrolytic copper; gastight crimped; acc. to DIN 46228, Part 4/09.90; red	www.wago.com/216-243	
Marking accessories			
	Item no.: 2009-110 Marking strips; on reel; not stretchable; plain; snap-on type; white	www.wago.com/2009-110	
	Item no.: 2009-113 WMB-Inline; for Smart Printer; on reel; plain; snap-on type; white	www.wago.com/2009-113	

	Item no.: 2009-113/000-002 WMB-Inline; for Smart Printer; on reel; plain; snap-on type; yellow	www.wago.com/2009-113/000-002
	Item no.: 2009-113/000-005 WMB-Inline; for Smart Printer; on reel; plain; snap-on type; red	www.wago.com/2009-113/000-005
	Item no.: 2009-113/000-006 WMB-Inline; for Smart Printer; on reel; plain; snap-on type; blue	www.wago.com/2009-113/000-006
	Item no.: 2009-113/000-007 WMB-Inline; for Smart Printer; on reel; plain; snap-on type; gray	www.wago.com/2009-113/000-007
	Item no.: 2009-113/000-012 WMB-Inline; for Smart Printer; on reel; plain; snap-on type; orange	www.wago.com/2009-113/000-012
	Item no.: 2009-113/000-017 WMB-Inline; for Smart Printer; on reel; plain; snap-on type; light green	www.wago.com/2009-113/000-017
	Item no.: 2009-113/000-023 WMB-Inline; for Smart Printer; on reel; plain; snap-on type; green	www.wago.com/2009-113/000-023
	Item no.: 2009-113/000-024 WMB-Inline; for Smart Printer; on reel; plain; snap-on type; violet	www.wago.com/2009-113/000-024
	Item no.: 793-3501 WMB marking card; as card; plain; snap-on type; white	www.wago.com/793-3501
check		
	Item no.: 2000-510 TOPJOB®S L-type test plug module; modular; for jumper contact slot; 1,00 mm ² ; gray	www.wago.com/2000-510
	Item no.: 2000-511 TOPJOB®S L-type test plug module; modular; for jumper contact slot; 1-pole; 1,00 mm ² ; gray	www.wago.com/2000-511
	Item no.: 2000-549 Spacer module; modular; e.g., for bridging commoned terminal blocks; gray	www.wago.com/2000-549
	Item no.: 2000-552 Modular TOPJOB®S connector; modular; for jumper contact slot; 2-pole; 1,00 mm ² ; gray	www.wago.com/2000-552
	Item no.: 2000-553 Modular TOPJOB®S connector; modular; for jumper contact slot; 3-pole; 1,00 mm ² ; gray	www.wago.com/2000-553
	Item no.: 2000-554 Modular TOPJOB®S connector; modular; for jumper contact slot; 4-pole; 1,00 mm ² ; gray	www.wago.com/2000-554
	Item no.: 2000-555 Modular TOPJOB®S connector; modular; for jumper contact slot; 5-pole; 1,00 mm ² ; gray	www.wago.com/2000-555
	Item no.: 2000-556 Modular TOPJOB®S connector; modular; for jumper contact slot; 6-pole; 1,00 mm ² ; gray	www.wago.com/2000-556

	Item no.: 2000-557 Modular TOPJOB®S connector; modular; for jumper contact slot; 7-pole; 1,00 mm ² ; gray	www.wago.com/2000-557
	Item no.: 2000-558 Modular TOPJOB®S connector; modular; for jumper contact slot; 8-pole; 1,00 mm ² ; gray	www.wago.com/2000-558
	Item no.: 2000-559 Modular TOPJOB®S connector; modular; for jumper contact slot; 9-pole; 1,00 mm ² ; gray	www.wago.com/2000-559
	Item no.: 2000-560 Modular TOPJOB®S connector; modular; for jumper contact slot; 10-pole; 1,00 mm ² ; gray	www.wago.com/2000-560
	Item no.: 2009-174 Test plug adapter; for 4 mm Ø test plugs; for testing TOPJOB®S rail-mounted terminal blocks; gray	www.wago.com/2009-174
	Item no.: 2009-182 Testing tap; for max. 2.5 mm ² ; tool-free connection for individual test wires 0.08 - 2.5 mm; gray	www.wago.com/2009-182
	Item no.: 210-136 Test plug; 2 mm Ø; with 500 mm cable; red	www.wago.com/210-136
	Item no.: 210-137 Test plug; 2.3 mm Ø; with 500 mm cable; yellow	www.wago.com/210-137
Carrier rail		
	Item no.: 210-112 Steel carrier rail; 35 x 7.5 mm; 1 mm thick; 2 m long; slotted; according to EN 60715; "Hole width 25 mm	www.wago.com/210-112
	Item no.: 210-113 Steel carrier rail; 35 x 7.5 mm; 1 mm thick; 2 m long; unslotted; according to EN 60715	www.wago.com/210-113
	Item no.: 210-114 Steel carrier rail; 35 x 15 mm; 1.5 mm thick; 2 m long; unslotted; similar to EN 60715	www.wago.com/210-114
	Item no.: 210-115 Steel carrier rail; 35 x 7.5 mm; 1 mm thick; 2 m long; slotted; according to EN 60715; "Hole width 18 mm	www.wago.com/210-115
	Item no.: 210-118 Steel carrier rail; 35 x 15 mm; 2.3 mm thick; 2 m long; unslotted; according to EN 60715	www.wago.com/210-118
	Item no.: 210-196 Aluminum carrier rail; 35 x 8.2 mm; 1.6 mm thick; 2 m long; unslotted; similar to EN 60715; silver-colored	www.wago.com/210-196
	Item no.: 210-197 Steel carrier rail; 35 x 15 mm; 1.5 mm thick; 2 m long; slotted; similar to EN 60715	www.wago.com/210-197
	Item no.: 210-198 Copper carrier rail; 35 x 15 mm; 2.3 mm thick; 2 m long; unslotted; according to EN 60715; copper-colored	www.wago.com/210-198
tools		
	Item no.: 210-647 Operating tool; Blade: 2.5 x 0.4 mm; with a partially insulated shaft	www.wago.com/210-647
	Item no.: 210-648 Operating tool with partially insulated shaft; Blade (2.5 x 0.4) mm; short; angled	www.wago.com/210-648



Item no.: 210-719
Operating tool; Blade: 2.5 x 0.4 mm; with a partially insulated shaft

www.wago.com/210-719

End plate



Item no.: 2000-1291
End and intermediate plate; 0.7 mm thick; gray

www.wago.com/2000-1291



Item no.: 2000-1292
End and intermediate plate; 0.7 mm thick; orange

www.wago.com/2000-1292

Jumper



Item no.: 2000-402
Push-in type jumper bar; insulated; 2-way; Nominal current 14 A; light gray

www.wago.com/2000-402



Item no.: 2000-402/000-005
Push-in type jumper bar; insulated; 2-way; Nominal current 14 A; red

www.wago.com/2000-402/000-005



Item no.: 2000-402/000-006
Push-in type jumper bar; insulated; 2-way; Nominal current 14 A; blue

www.wago.com/2000-402/000-006



Item no.: 2000-402/000-018
Push-in type jumper bar; insulated; 2-way; Nominal current 14 A; yellow-green

www.wago.com/2000-402/000-018



Item no.: 2000-403
Push-in type jumper bar; insulated; 3-way; Nominal current 14 A; light gray

www.wago.com/2000-403



Item no.: 2000-403/000-005
Push-in type jumper bar; insulated; 3-way; Nominal current 14 A; red

www.wago.com/2000-403/000-005



Item no.: 2000-403/000-006
Push-in type jumper bar; insulated; 3-way; Nominal current 14 A; blue

www.wago.com/2000-403/000-006



Item no.: 2000-404
Push-in type jumper bar; insulated; 4-way; Nominal current 14 A; light gray

www.wago.com/2000-404



Item no.: 2000-404/000-005
Push-in type jumper bar; insulated; 4-way; Nominal current 14 A; red

www.wago.com/2000-404/000-005



Item no.: 2000-404/000-006
Push-in type jumper bar; insulated; 4-way; Nominal current 14 A; blue

www.wago.com/2000-404/000-006



















Item no.: 2000-405
Push-in type jumper bar; insulated; 5-way; Nominal current 14 A; light gray

















www.wago.com/2000-405



Item no.: 2000-405/000-005
Push-in type jumper bar; insulated; 5-way; Nominal current 14 A; red

www.wago.com/2000-405/000-005

	Item no.: 2000-405/000-006 Push-in type jumper bar; insulated; 5-way; Nominal current 14 A; blue	www.wago.com/2000-405/000-006
	Item no.: 2000-405/011-000 Star point jumper; insulated; 3-way (1-3-5); IN = IN terminal block; light gray	www.wago.com/2000-405/011-000
	Item no.: 2000-406 Push-in type jumper bar; insulated; 6-way; Nominal current 14 A; light gray	www.wago.com/2000-406
	Item no.: 2000-406/000-005 Push-in type jumper bar; insulated; 6-way; Nominal current 14 A; red	www.wago.com/2000-406/000-005
	Item no.: 2000-406/000-006 Push-in type jumper bar; insulated; 6-way; Nominal current 14 A; blue	www.wago.com/2000-406/000-006
	Item no.: 2000-406/020-000 Delta jumper; insulated; 1-2 3-4 5-6; IN = IN terminal block; light gray	www.wago.com/2000-406/020-000
	Item no.: 2000-407 Push-in type jumper bar; insulated; 7-way; Nominal current 14 A; light gray	www.wago.com/2000-407
	Item no.: 2000-407/000-005 Push-in type jumper bar; insulated; 7-way; Nominal current 14 A; red	www.wago.com/2000-407/000-005
	Item no.: 2000-407/000-006 Push-in type jumper bar; insulated; 7-way; Nominal current 14 A; blue	www.wago.com/2000-407/000-006
	Item no.: 2000-408 Push-in type jumper bar; insulated; 8-way; Nominal current 14 A; light gray	www.wago.com/2000-408
	Item no.: 2000-408/000-005 Push-in type jumper bar; insulated; 8-way; Nominal current 14 A; red	www.wago.com/2000-408/000-005
	Item no.: 2000-408/000-006 Push-in type jumper bar; insulated; 8-way; Nominal current 14 A; blue	www.wago.com/2000-408/000-006
	Item no.: 2000-409 Push-in type jumper bar; insulated; 9-way; Nominal current 14 A; light gray	www.wago.com/2000-409
	Item no.: 2000-409/000-005 Push-in type jumper bar; insulated; 9-way; Nominal current 14 A; red	www.wago.com/2000-409/000-005
	Item no.: 2000-409/000-006 Push-in type jumper bar; insulated; 9-way; Nominal current 14 A; blue	www.wago.com/2000-409/000-006
	Item no.: 2000-410 Push-in type jumper bar; insulated; 10-way; Nominal current 14 A; light gray	www.wago.com/2000-410

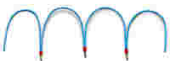
	<p>Item no.: 2000-410/000-005</p> <p>Push-in type jumper bar; insulated; 10-way; Nominal current 14 A; red</p>	www.wago.com/2000-410/000-005
	<p>Item no.: 2000-410/000-006</p> <p>Push-in type jumper bar; insulated; 10-way; Nominal current 14 A; blue</p>	www.wago.com/2000-410/000-006
	<p>Item no.: 2000-433</p> <p>Push-in type jumper bar; insulated; from 1 to 3; Nominal current 14 A; light gray</p>	www.wago.com/2000-433
	<p>Item no.: 2000-433/000-005</p> <p>Push-in type jumper bar; insulated; from 1 to 3; Nominal current 14 A; red</p>	www.wago.com/2000-433/000-005
	<p>Item no.: 2000-433/000-006</p> <p>Push-in type jumper bar; insulated; from 1 to 3; Nominal current 14 A; blue</p>	www.wago.com/2000-433/000-006
	<p>Item no.: 2000-434</p> <p>Push-in type jumper bar; insulated; from 1 to 4; Nominal current 14 A; light gray</p>	www.wago.com/2000-434
	<p>Item no.: 2000-435</p> <p>Push-in type jumper bar; insulated; from 1 to 5; Nominal current 14 A; light gray</p>	www.wago.com/2000-435
	<p>Item no.: 2000-436</p> <p>Push-in type jumper bar; insulated; from 1 to 6; Nominal current 14 A; light gray</p>	www.wago.com/2000-436
	<p>Item no.: 2000-437</p> <p>Push-in type jumper bar; insulated; from 1 to 7; Nominal current 14 A; light gray</p>	www.wago.com/2000-437
	<p>Item no.: 2000-438</p> <p>Push-in type jumper bar; insulated; from 1 to 8; Nominal current 14 A; light gray</p>	www.wago.com/2000-438
	<p>Item no.: 2000-439</p> <p>Push-in type jumper bar; insulated; from 1 to 9; Nominal current 14 A; light gray</p>	www.wago.com/2000-439
	<p>Item no.: 2000-440</p> <p>Push-in type jumper bar; insulated; from 1 to 10; Nominal current 14 A; light gray</p>	www.wago.com/2000-440
	<p>Item no.: 2009-402</p> <p>Push-in type wire jumper; insulated; wire length 60 mm; Conductor cross section 0.75 mm²; suitable for 2000 and 2020 Series rail-mounted terminal blocks; gray</p>	www.wago.com/2009-402
	<p>Item no.: 2009-404</p> <p>Push-in type wire jumper; insulated; wire length 110 mm; Conductor cross section 0.75 mm²; suitable for 2000 and 2020 Series rail-mounted terminal blocks; gray</p>	www.wago.com/2009-404
	<p>Item no.: 2009-406</p> <p>Push-in type wire jumper; insulated; wire length 250 mm; Conductor cross section 0.75 mm²; suitable for 2000 and 2020 Series rail-mounted terminal blocks; gray</p>	www.wago.com/2009-406
	<p>Item no.: 210-103</p> <p>Wire commoning chain; insulated; 50 connections; black</p>	www.wago.com/210-103
	<p>Item no.: 210-123</p> <p>Wire commoning chain; insulated; 50 connections</p>	www.wago.com/210-123



Downloads

Documentation

Bid Text

2200-1201		docx 14.9 kB	Download
-----------	--	-----------------	----------

Additional Information

Technical explanations	Apr 3, 2019	pdf 2.1 MB	Download
------------------------	-------------	---------------	----------

CAD/CAE-Data

CAD data

3D Download 2200-1201		URL	Download
-----------------------	--	-----	----------

EPLAN

EPLAN Data Portal			Download
-------------------	--	--	----------

Subject to changes.