

# SU CULBN1.VC

## OSLON® UV 3636

This compact UV-C LED is part of the OSLON UV series.

It allows a flexible design for any application which requires UV-C radiation for e.g. disinfection, purification, treatment or sensing.

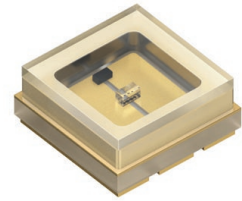

## Applications

- Equipment Illumination (e.g. Curing, Endoscope)
- Smoke/Dust/Particle Sensing
- UV-C Air Disinfection
- UV-C Surface Disinfection
- UV-C Water Disinfection

## Features:

- Package: Ceramic package with integrated glass cover
- Chip technology: AlGaIn based Flip chip
- Typ. Radiation: 120° (Lambertian emitter)
- Color:  $\lambda_{\text{peak}} = 275 \text{ nm}$  (• ultraviolet (UV-C))
- ESD: 2 kV acc. to ANSI/ESDA/JEDEC JS-001 (HBM)
- Radiant Flux: typ. 4.7 mW
- Radiant Efficiency: typ. 2.6 %

## Ordering Information

Type	Radiant Intensity <sup>1)</sup> $I_F = 30 \text{ mA}$ $I_e$	Ordering Code
SU CULBN1.VC-AGAY-67-4F4G	4.0 ... 12.0 mW	Q65113A2366

---

## Maximum Ratings

Parameter	Symbol		Values
Operating Temperature	$T_{op}$	min.	-40 °C
		max.	60 °C
Storage Temperature	$T_{stg}$	min.	-40 °C
		max.	100 °C
Junction Temperature	$T_j$	max.	65 °C
Forward current $T_s = 25\text{ °C}$	$I_F$	min.	1 mA
		max.	40 mA
Surge Current $T_s = 25\text{ °C}$	$I_{FS}$	max.	50 mA
Reverse voltage <sup>2)</sup> $T_s = 25\text{ °C}$	$V_R$	max.	5 V
ESD withstand voltage acc. to ANSI/ESDA/JEDEC JS-001 (HBM)	$V_{ESD}$		2 kV

## Characteristics

$I_F = 30 \text{ mA}$ ;  $T_s = 25 \text{ °C}$

Parameter	Symbol		Values
Peak Wavelength <sup>3)</sup>	$\lambda_{\text{peak}}$	min. typ. max.	270 nm 275 nm 280 nm
Viewing angle at 50% $I_V$	$2\varphi$	typ.	120 °
Forward Voltage <sup>4)</sup> $I_F = 30 \text{ mA}$	$V_F$	min. typ. max.	5.50 V 6.00 V 6.50 V
Reverse voltage <sup>2)</sup>	$V_R$	max.	5 V
Real thermal resistance junction/solderpoint <sup>5)</sup>	$R_{\text{thJS real}}$	typ.	25 K / W
Electrical thermal resistance junction/solderpoint with efficiency $\eta_e = 2.6 \%$	$R_{\text{thJS elec.}}$	typ.	24 K / W

## Brightness Groups

Group	Radiant Intensity <sup>1)</sup> $I_F = 30 \text{ mA}$ min. $I_e$	Radiant Intensity <sup>1)</sup> $I_F = 30 \text{ mA}$ max. $I_e$
AG	4.0 mW	4.5 mW
AH	4.5 mW	5.0 mW
AJ	5.0 mW	5.5 mW
AK	5.5 mW	6.0 mW
AL	6.0 mW	6.5 mW
AM	6.5 mW	7.0 mW
AN	7.0 mW	7.5 mW
AP	7.5 mW	8.0 mW
AQ	8.0 mW	8.5 mW
AR	8.5 mW	9.0 mW
AS	9.0 mW	9.5 mW
AT	9.5 mW	10.0 mW
AU	10.0 mW	10.5 mW
AV	10.5 mW	11.0 mW
AW	11.0 mW	11.5 mW
AY	11.5 mW	12.0 mW

## Forward Voltage Groups

Group	Forward Voltage <sup>4)</sup> $I_F = 30 \text{ mA}$ min. $V_F$	Forward Voltage <sup>4)</sup> $I_F = 30 \text{ mA}$ max. $V_F$
4F	5.50 V	6.00 V
4G	6.00 V	6.50 V

## Wavelength Groups

Group	Peak Wavelength <sup>3)</sup> min. $\lambda_{\text{peak}}$	Peak Wavelength <sup>3)</sup> max. $\lambda_{\text{peak}}$
6	270 nm	275 nm
7	275 nm	280 nm

---

### Group Name on Label

**Example: AG-6-4F**

Brightness	Wavelength	Forward Voltage
AG	6	4F

---

### Relative Spectral Emission <sup>6)</sup>

$I_{rel} = f(\lambda); I_F = 30 \text{ mA}; T_S = 25 \text{ }^\circ\text{C}$

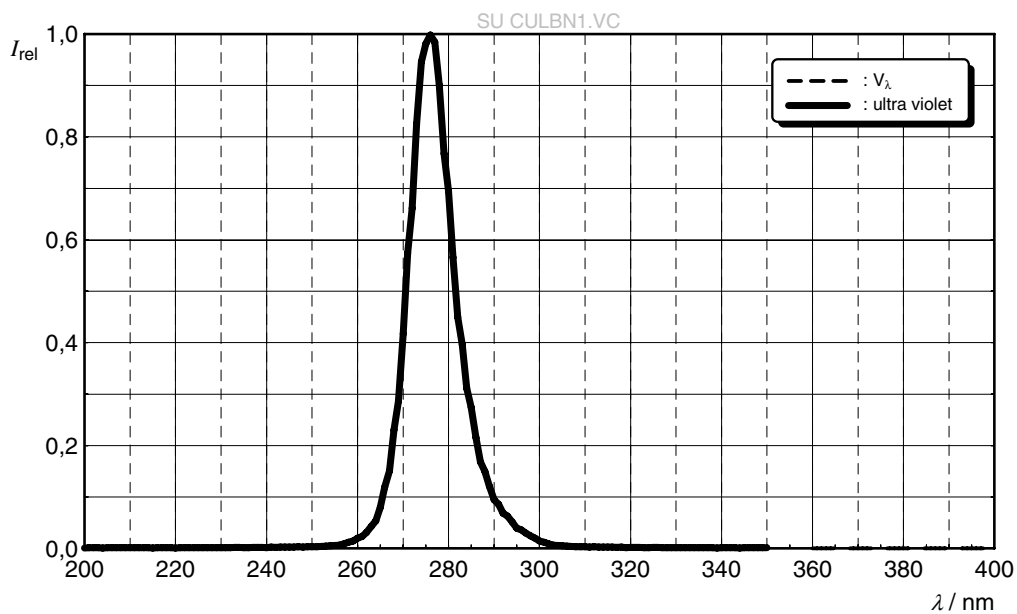

### Radiation Characteristics <sup>6)</sup>

$I_{rel} = f(\phi); T_S = 25 \text{ }^\circ\text{C}$

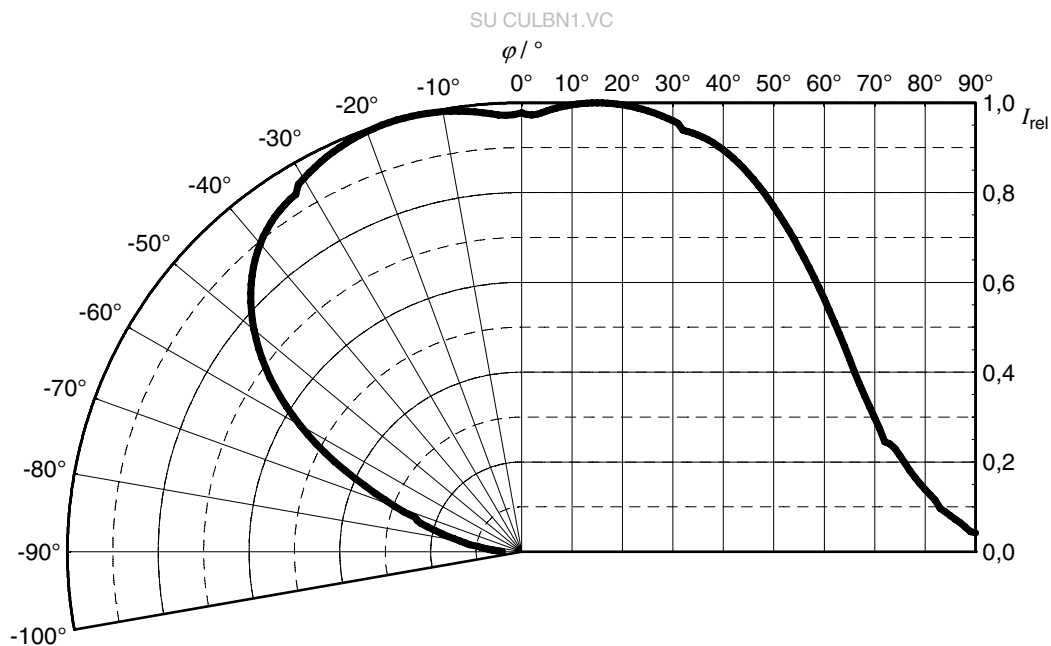



**Forward current** <sup>6)</sup>

$I_F = f(V_F); T_S = 25\text{ °C}$

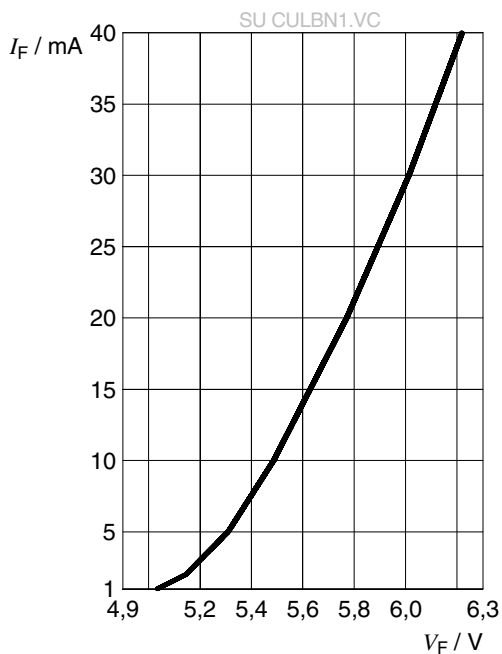

**Relative Radiant Power** <sup>6), 7)</sup>

$\Phi_E / \Phi_E(30\text{ mA}) = f(I_F); T_S = 25\text{ °C}$

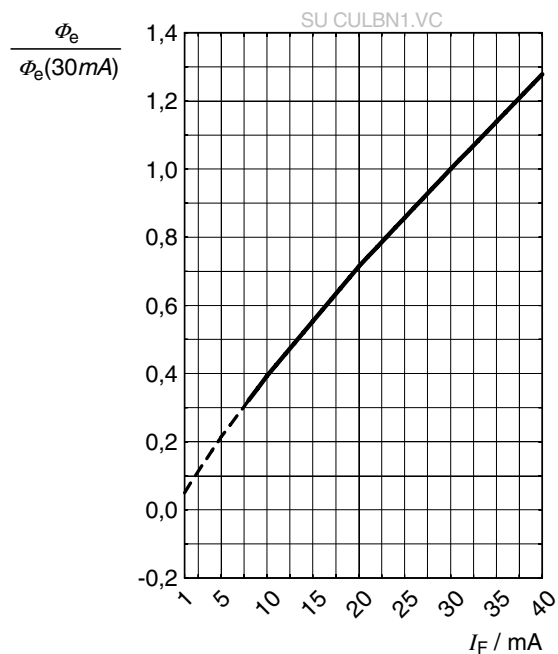

**Peak Wavelength** <sup>6)</sup>

$\lambda_{\text{peak}} = f(T_j); I_F = 30\text{ mA}$

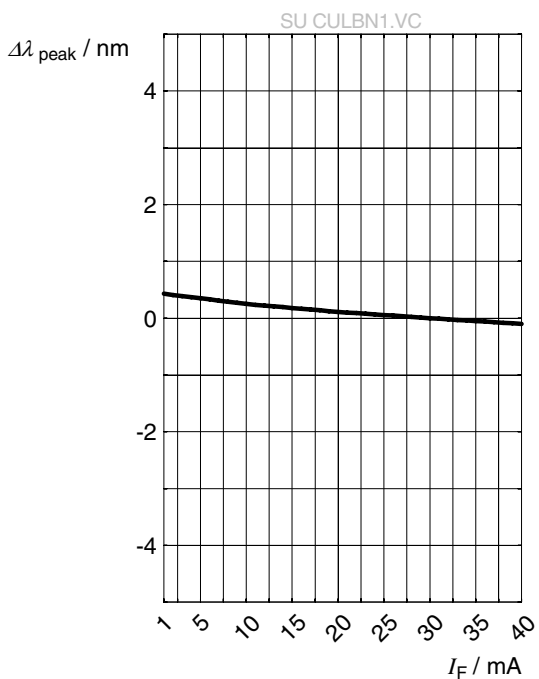

### Forward Voltage <sup>6)</sup>

$$\Delta V_F = V_F - V_F(25\text{ }^\circ\text{C}) = f(T_j); I_F = 30\text{ mA}$$

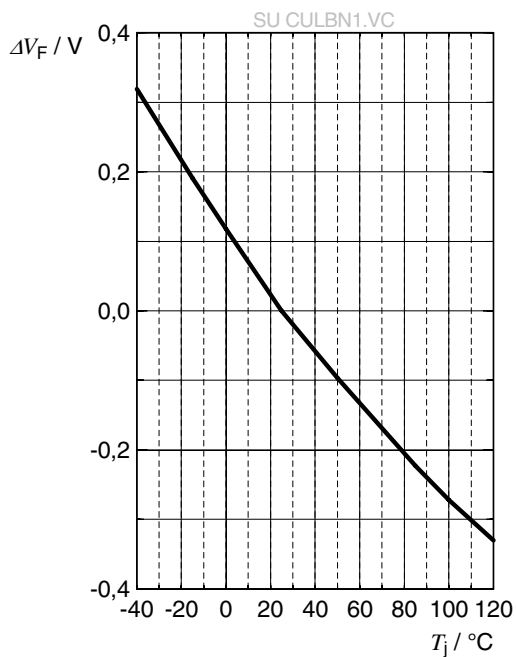

### Relative Radiant Power <sup>6)</sup>

$$\Phi_E / \Phi_E(25\text{ }^\circ\text{C}) = f(T_j); I_F = 30\text{ mA}$$

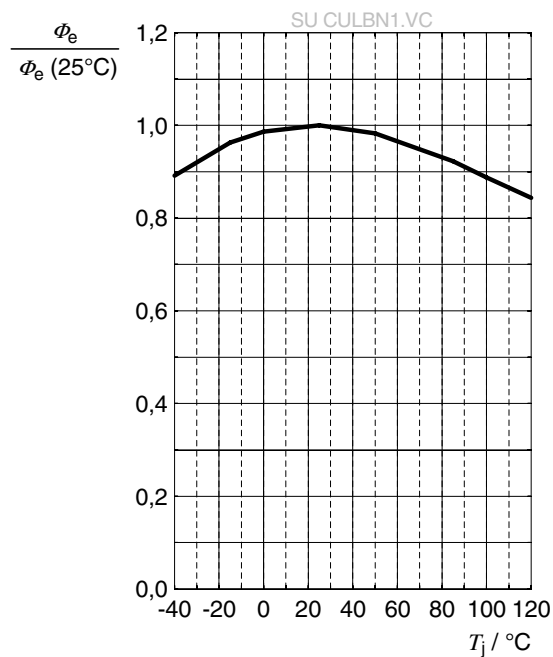

### Peak Wavelength <sup>6)</sup>

$$\lambda_{\text{peak}} = f(T_j); I_F = 30\text{ mA}$$

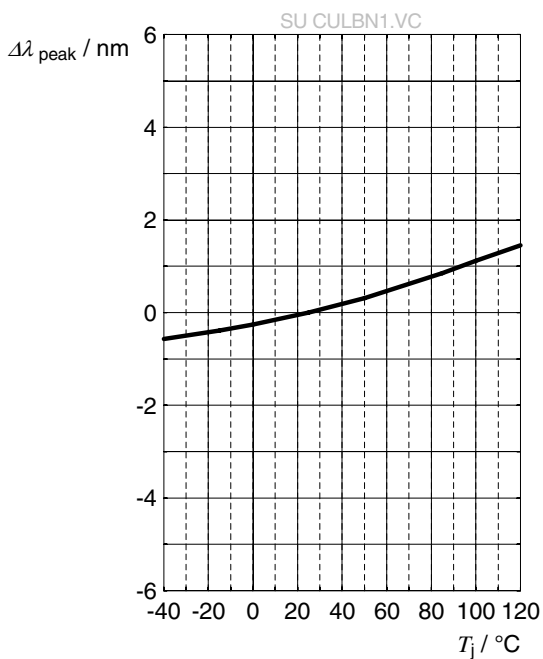

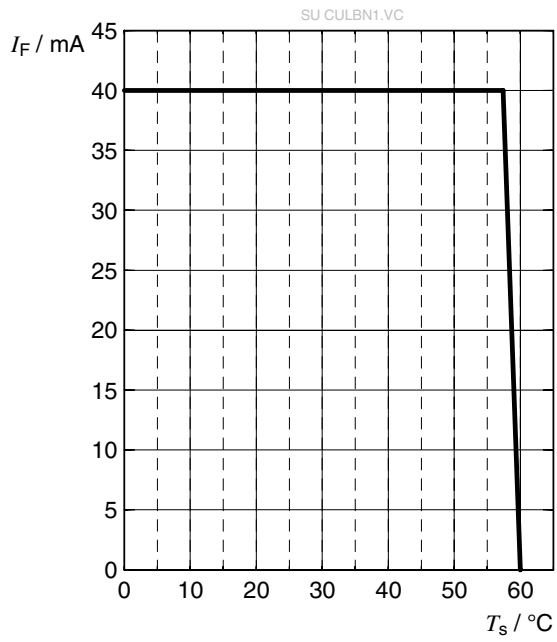

## Max. Permissible Forward Current

$$I_F = f(T)$$

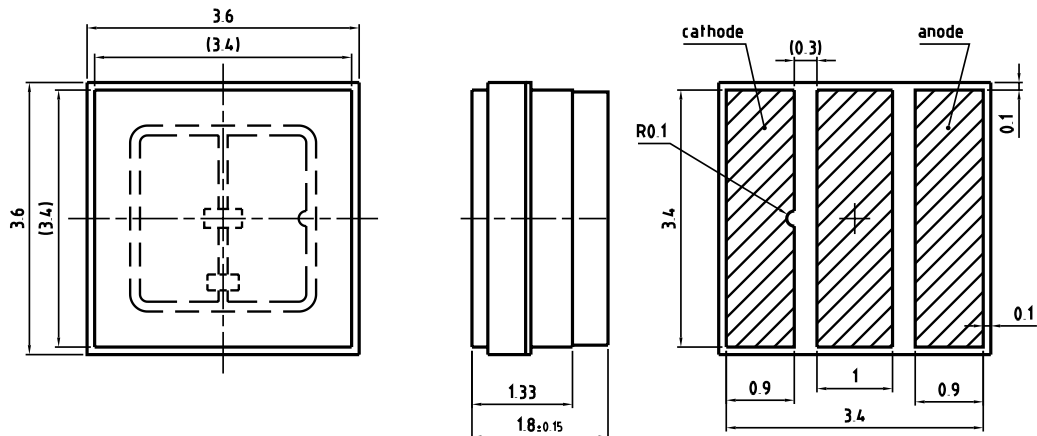

## Dimensional Drawing <sup>8)</sup>



general tolerance  $\pm 0.1$   
 lead finish Au 

C67062-A0383-A1-02

## Further Information:

**Approximate Weight:** 82.6 mg

**Package marking:** Cathode

**ESD advice:** LED is protected by ESD device which is connected in parallel to LED-Chip.

## Recommended Solder Pad <sup>8)</sup>

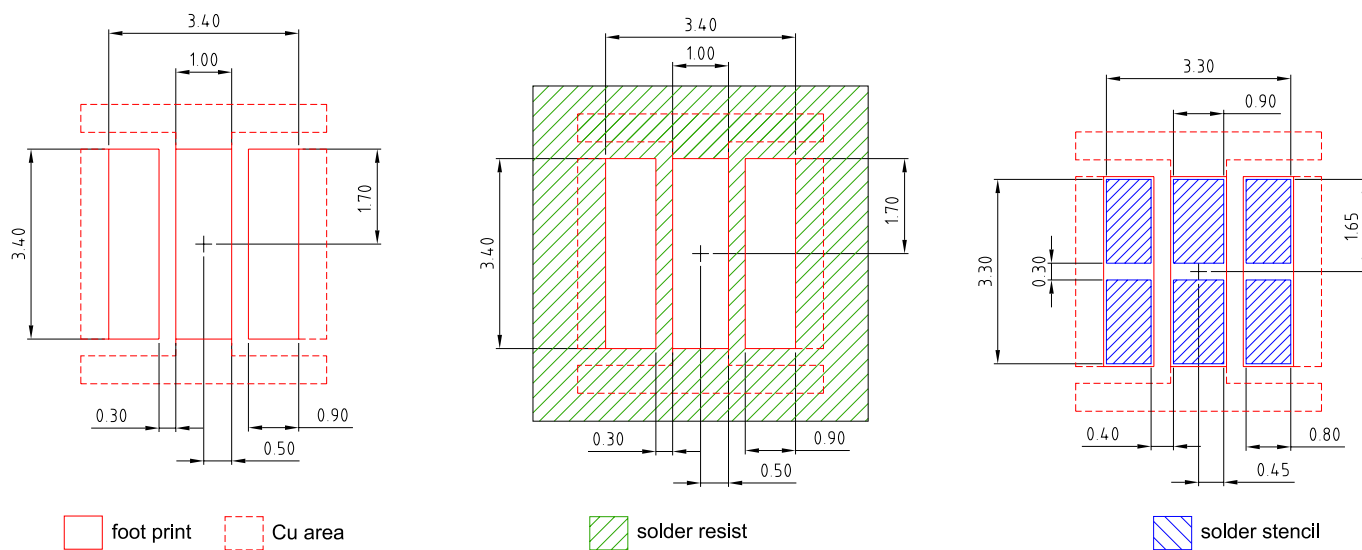

E067.0346.19-01

For superior solder joint connectivity results we recommend soldering under standard nitrogen atmosphere. Package not suitable for any kind of wet cleaning or ultrasonic cleaning.

Taping <sup>8)</sup>

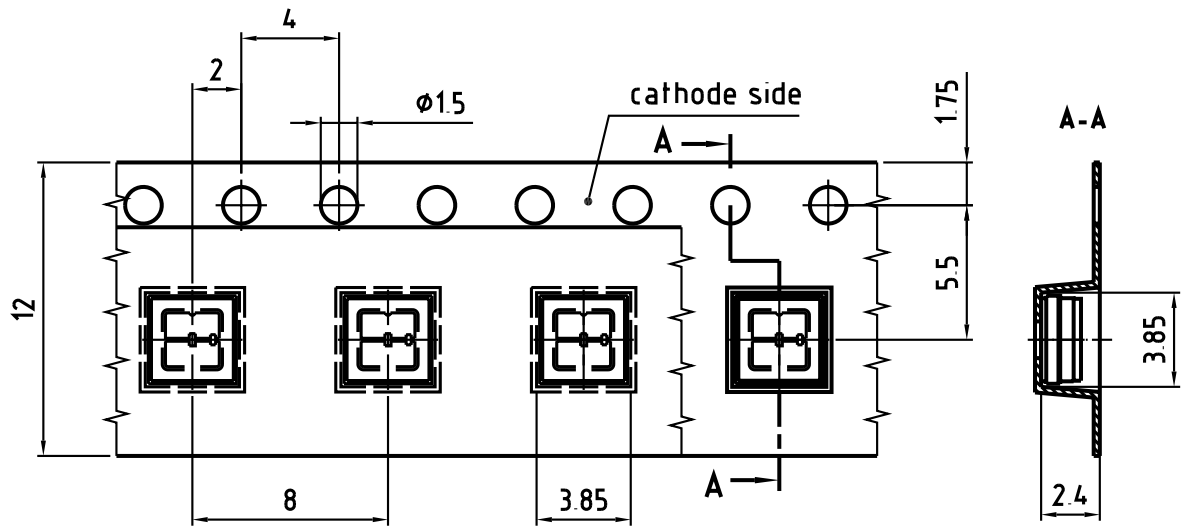

C67062-A0383-B1-01

**Tape and Reel** <sup>9)</sup>



**Reel Dimensions**



A	W	N <sub>min</sub>	W <sub>1</sub>	W <sub>2max</sub>	Pieces per PU
180 mm	12 + 0.3 / - 0.1 mm	60 mm	12.4 + 2 mm	18.4 mm	500

Barcode-Product-Label (BPL)

**OSRAM Opto Semiconductors** LX XXXX    BIN1: XX-XX-X-XXX-X

RoHS Compliant

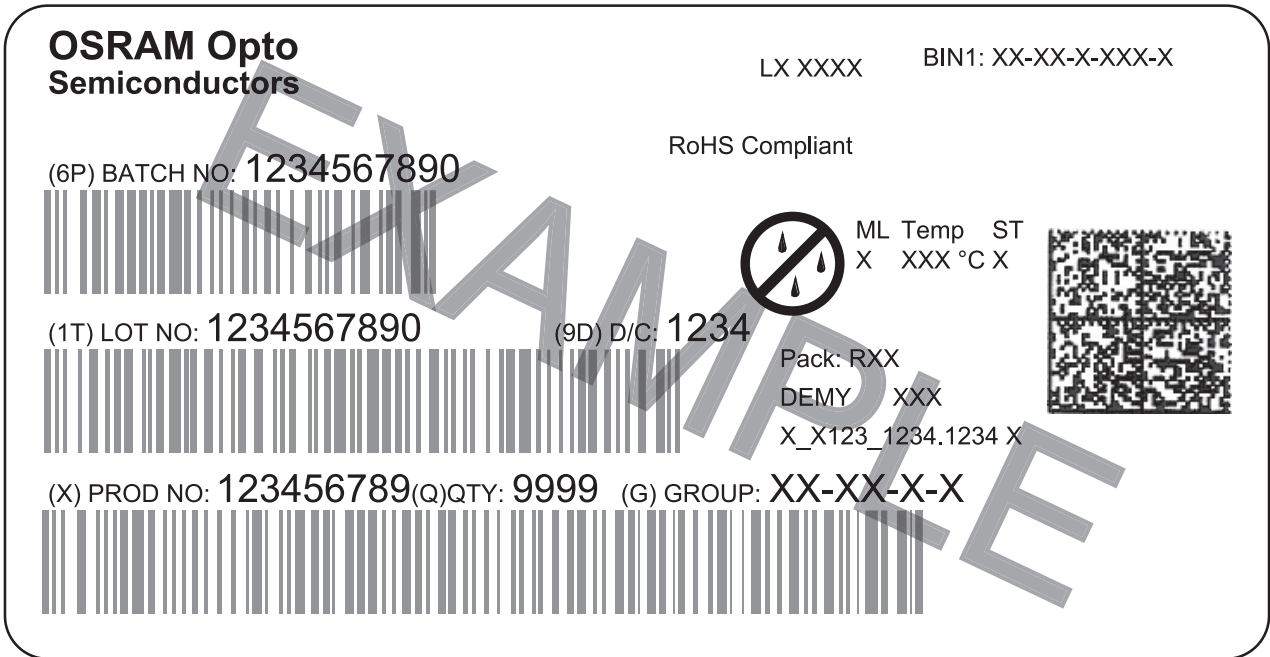
(6P) BATCH NO: 1234567890 ML Temp    ST  
X    XXX °C X





(1T) LOT NO: 1234567890 (9D) D/C: 1234



Pack: RXX  
DEMY    XXX  
X\_X123\_1234.1234 X

(X) PROD NO: 123456789(Q)QTY: 9999 (G) GROUP: XX-XX-X-X



OHA04563

Dry Packing Process and Materials <sup>8)</sup>

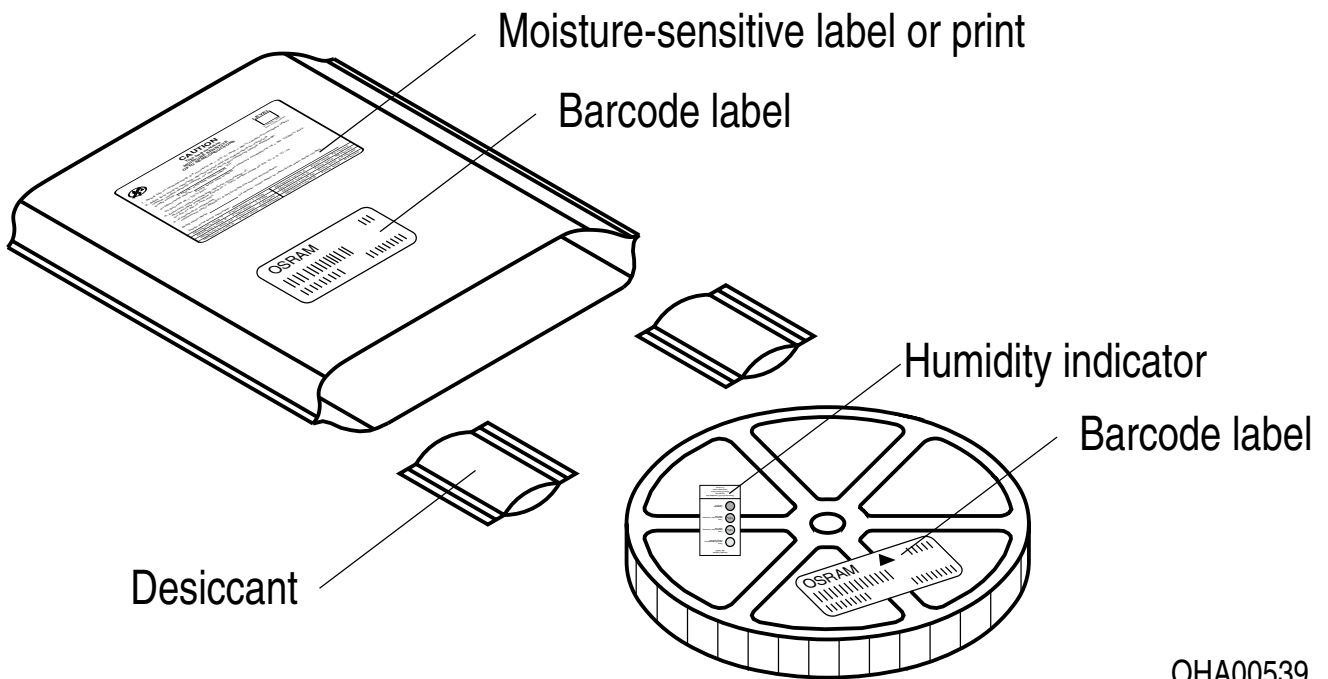

OHA00539

Moisture-sensitive product is packed in a dry bag containing desiccant and a humidity card according JEDEC-STD-033.



## Notes

The evaluation of eye safety occurs according to the standard IEC 62471:2006 (photo biological safety of lamps and lamp systems). Within the risk grouping system of this IEC standard, the device specified in this data sheet falls into high risk group – RG3. WARNING - UV emitted from this product. Avoid eye and skin contact to unshielded product.

Subcomponents of this device contain, in addition to other substances, metal filled materials including silver. Metal filled materials can be affected by environments that contain traces of aggressive substances. Therefore, we recommend that customers minimize device exposure to aggressive substances during storage, production, and use. Devices that showed visible discoloration when tested using the described tests above did show no performance deviations within failure limits during the stated test duration. Respective failure limits are described in the IEC60810.

For further application related information please visit [www.osram-os.com/appnotes](http://www.osram-os.com/appnotes)

## Disclaimer

### **Attention please!**

The information describes the type of component and shall not be considered as assured characteristics. Terms of delivery and rights to change design reserved. Due to technical requirements components may contain dangerous substances.

For information on the types in question please contact our Sales Organization.

If printed or downloaded, please find the latest version on the OSRAM OS website.

### **Packing**

Please use the recycling operators known to you. We can also help you – get in touch with your nearest sales office. By agreement we will take packing material back, if it is sorted. You must bear the costs of transport. For packing material that is returned to us unsorted or which we are not obliged to accept, we shall have to invoice you for any costs incurred.

### **Product and functional safety devices/applications or medical devices/applications**

OSRAM OS components are not developed, constructed or tested for the application as safety relevant component or for the application in medical devices.

OSRAM OS products are not qualified at module and system level for such application.

In case buyer – or customer supplied by buyer – considers using OSRAM OS components in product safety devices/applications or medical devices/applications, buyer and/or customer has to inform the local sales partner of OSRAM OS immediately and OSRAM OS and buyer and /or customer will analyze and coordinate the customer-specific request between OSRAM OS and buyer and/or customer.

---

## Glossary

- 1) **Brightness:** Brightness groups are tested at a current pulse duration of 25 ms and a tolerance of  $\pm 11\%$ .
- 2) **Reverse Operation:** This product is intended to be operated applying a forward current within the specified range. Applying any continuous reverse bias or forward bias below the voltage range of light emission shall be avoided because it may cause migration which can change the electro-optical characteristics or damage the LED.
- 3) **Wavelength:** Wavelengths are tested at a current pulse duration of 25 ms and a tolerance of  $\pm 1$  nm.
- 4) **Forward Voltage:** Forward voltages are tested at a current pulse duration of 1 ms and a tolerance of  $\pm 0.1$  V.
- 5) **Thermal Resistance:**  $R_{th\ max}$  is based on statistic values ( $6\sigma$ ).
- 6) **Typical Values:** Due to the special conditions of the manufacturing processes of semiconductor devices, the typical data or calculated correlations of technical parameters can only reflect statistical figures. These do not necessarily correspond to the actual parameters of each single product, which could differ from the typical data and calculated correlations or the typical characteristic line. If requested, e.g. because of technical improvements, these typ. data will be changed without any further notice.
- 7) **Characteristic curve:** In the range where the line of the graph is broken, you must expect higher differences between single devices within one packing unit.
- 8) **Tolerance of Measure:** Unless otherwise noted in drawing, tolerances are specified with  $\pm 0.1$  and dimensions are specified in mm.
- 9) **Tape and Reel:** All dimensions and tolerances are specified acc. IEC 60286-3 and specified in mm.

## Revision History

Version	Date	Change
1.0	2020-11-27	Initial Version

---

Published by OSRAM Opto Semiconductors GmbH EU RoHS and China RoHS compliant product  
Leibnizstraße 4, D-93055 Regensburg  
www.osram-os.com © All Rights Reserved.



此产品符合欧盟 RoHS 指令的要求；  
按照中国的相关法规和标准，不含有毒有害物质或元素。