



JPL Spitfire

User Guide

Mini Conference Room Video Sound Bar with Intelligent Zoom





Unpacking

Remove your camera from its packaging and ensure you have the correct specified accessories. Retain the camera box for storage, and also in the unlikely event that it needs to be returned for servicing or repair.

Warning

Ensure that all electrical connections (including extension leads and interconnections between pieces of equipment) are properly made and in accordance with the relevant manufacturer's instructions.

- Do not continue to operate the equipment if you are in any doubt about it working normally, or if it is damaged in any way. If this is the case, disconnect the unit from your PC equipment and consult your dealer.
- Do not allow electrical equipment to be exposed to rain or moisture.
- Never push anything into holes, slots or any other opening on your camera as this could result in a fatal electrical shock.
- Do not open the camera housing as doing so will void the warranty.
- Never guess or take chances with electrical equipment.

General Limitation of Liability

The device is not designed, manufactured, or intended for use or resale, in environments that require fail-safe performance, such as in the operation of life-support systems and/or nuclear facilities. The device may only be used for these purposes with prior written permission from the manufacturer in each individual case.

Declaration of Conformity

This device complies with the basic health, safety and environmental requirements in all relevant directives. You will find the Declaration of Conformity on our website. www.jpltele.com

Safety

For your own safety, this product should only be used with UKCA, CE, FCC, and RoHS approved equipment. Using this camera with non-approved equipment can void this products warranty.

Unplug this product from the power outlet before cleaning. Do not use liquid cleaners or aerosol cleaners. Use a damp cloth for cleaning.

Do not overload outlets and extension cords as this can result in risk of fire or electric shock.

Environmental Notice

This camera has been made to UKCA, CE, FCC, RoHS, and WEEE standards. In the interest of recycling raw materials, please do not dispose of this camera in the household waste at the end of its useful life. Disposal can take place at approved recycling or disposing locations in accordance with local regulations.

Consult your responsible authority for information about the professional and environment-friendly disposal of your device. If you want that we handle the disposal for you, you can send the device at your costs to JPL Telecom Limited.





Contents

What's Included	4
Overview	5
Features	6
Setting up your conference room camera	7
Connecting your 4K camera	8
Using your 4K camera	8
Optimal Performance	8
Technical Information	9
- Camera Parameters	
- Microphone Parameters	
- Speaker Parameters	
- Other Parameters	
Trouble Shooting	10
Conditions of Warranty	11



What's Included

Thank you for choosing the JPL Spitfire Mini Conference Room Video Sound Bar with Intelligent Zoom.

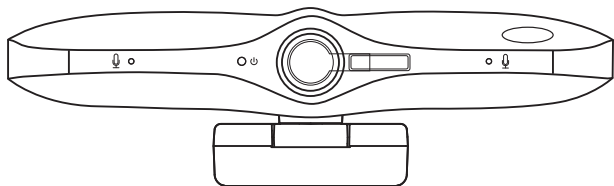

Mini Conference Room Video Sound Bar
with Intelligent Zoom

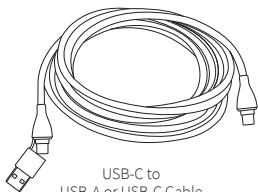

USB-C to
USB-A or USB-C Cable

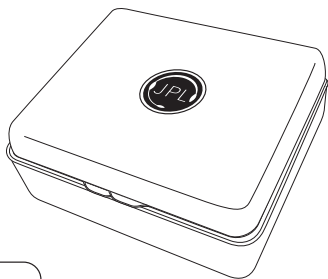

Clam Shell Carry Case

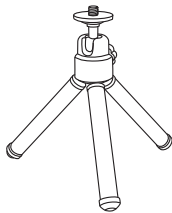

Mini Tripod

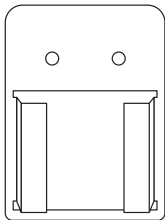

Wall Bracket



Wall Bracket Fixings



Overview

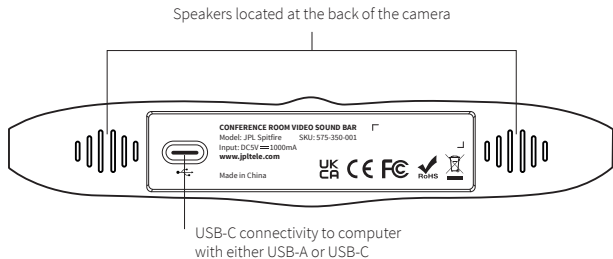
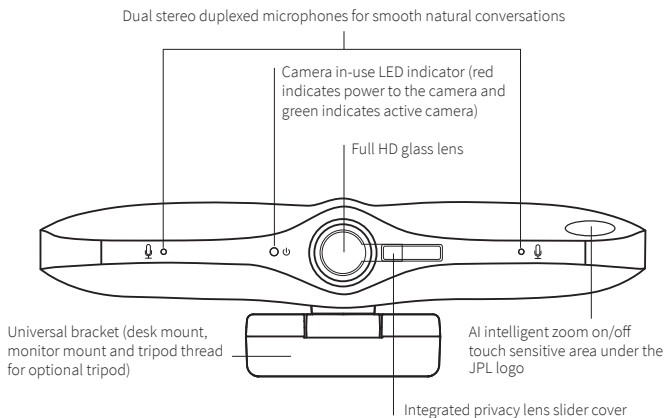



Features

- 4K UHD 3840 x 2160p
- Plug & play solution - No software download needed
- Intelligent zoom, powered by AI - Tracking to focus on the people in the room
- Full HD 4K Sony glass lens - No optical distortion
- 96° Field of view - 8 person conference room suitable
- Integrated privacy lens cover
- 2 x Built-in duplex stereo microphones, 5m voice pick up
- 2 x Built-in speakers
- Desk mount, monitor mount and universal thread for tripod option
- Full 360° rotation including 90° tilt for over desk viewing
- Built-in, camera in-use, LED indicator
- Automatic low-light correction
- AEC - Automatic Echo Cancellation
- ANS - Automatic Noise Suppression
- Protective carry case, lightweight desktop tripod and wall bracket included
- USB 2.0 Type-A and USB Type-C connectivity
- Compatible with all computers (Mac or PC) and softphones
- *3 years limited warranty
(*2 years standard repair or replacement warranty plus a 3rd year cover on the camera only)



Setting up your conference room video sound bar

1. Designed with a fully adjustable mount, the JPL Spitfire can be placed above a computer monitor, positioned on a desktop, or mounted on a wall or ceiling.

(a) Monitor Mount

Grasp the camera in one hand and open the flexible clip base with your other hand. Mount the camera onto the top of the monitor, making sure that the foot on the flexible clip base is flat with the back of the monitor.

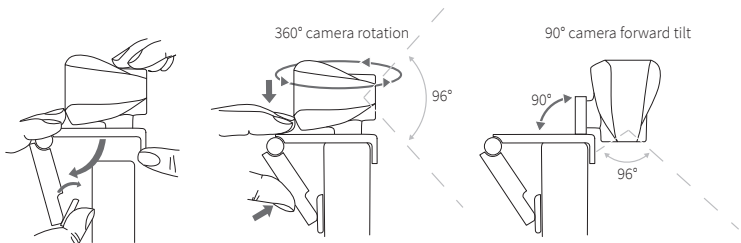

(b) Mini Tripod

The mini tripod can be attached to the base of the adjustable bracket and placed on a desk or counter top.

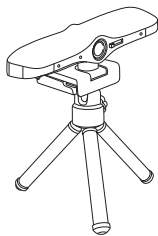

(c) Wall Mount

Drill holes in the wall that match the pre-drilled holes on the back of the mount.

⚠ Make sure to check you are not drilling into any electrical wires hidden within the wall.

Put rawl plugs into the drilled holes and then attach the mount to the wall using the screws supplied.

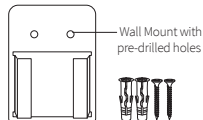



Connecting your conference room video sound bar

Connecting the USB adapter to your computer's USB-A or USB-C port is a simple plug & play process. No other action is required. There is no software download needed.

To enable full functionality of the video sound bar, the JPL Spitfire must be connected directly to your computer, or to a powered hub.

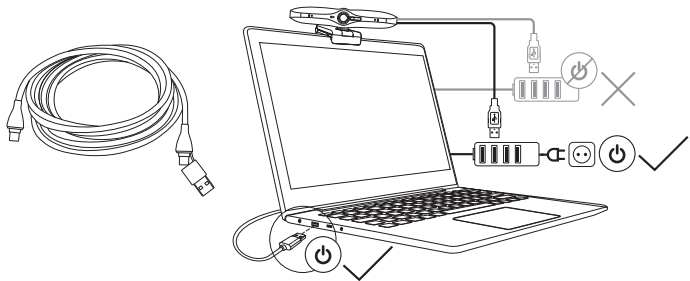

Using your conference room video sound bar

Once you have connected the camera to your computer via the USB cable you can open the visual collaboration software of your choice: Microsoft Teams®, Zoom®, WebRTC, Webex, Bluejeans® etc. Most collaboration software packages allow you to choose your devices. Simply select the JPL Spitfire for both microphone and camera.

Optimal Performance

- Do not sit in front of a window or other bright light source.
- Having an uncluttered background to ensure your viewers are concentrating on you.
- The mounting system allows for tilting and aiming the camera. While sitting in your normal position, your entire face or conference room should be just above the middle of the picture. Tilt and move the camera to frame up a good view.

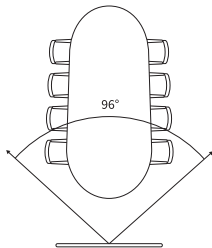



Technical Information

Camera parameters:

Total Pixels	8.3 million pixels - 4K resolution
Aperture	F/No. $\approx 2.5 \pm 5\%$
Focal length	F=2.95mm
Maximum effective pixel	3840 x 2160
Output image format	MJPEG and YUV
Field of view	96°
AI Zoom	5 x AI Zoom
Minimum Illumination	0.5 Lux at F2.0
Exposure	Automatic Exposure (AE)
Automatic image control functions	Auto White Balance (AWB), Dynamic Black Level, Calibration (ABLC)
Resolution @ 30fps	3840 x 2160, 2560 x 1440, 1080p, 720p, VGA

Microphone parameters:

Microphone quantity	2
SNR	≥ 60 dB
Sensitivity	-38 \pm 3dB (2.0V 2.2K Ω)
Far-field distance	5 meters voice pickup
Horizontal voice pickup	Omnidirectional microphone
Communication mode	USB 2.0
Digital Signal Processing	Automatic: gain control, noise reduction and echo noise reduction control

Speaker parameters:

Sampling rate	48kHz
Speaker power	1W*2pcs
Directivity	Omnidirectional
Rated impedance	8 $\Omega \pm 5\%$

Other parameters:

Interface type	USB 2.0 Type-A or USB Type-C
Voltage	DC 5V / 1000mA
OS Support	Win 7/Win 8/Win 10 Mac - OS X 10.10 or later Android 5.0 or above with UVC
Power	1.5W



Trouble Shooting

1. No image displayed

- a) Check if the USB port and USB cable of the terminal device are connected correctly.
- b) Check if the USB cable is stable.
- c) Check if the USB port is working.
- d) Check your softphone software is selecting the JPL Spitfire.

2. The image breaks frequently

- a) Check if the USB port and USB cable of the terminal device are connected correctly.
- b) Check if the USB cable is stable.

3. The definition is not good after accessing software

- a) Check your software video input settings to see if the camera video input is set correctly.

4. No microphone TX sound

- a) Check your softphone software is selecting the JPL Spitfire.
- b) Check you have not muted the sound by accident.

5. Is my camera's video preview image too bright or too dark?

- a) Change brightness settings in camera application.

For further support you can visit our website <https://www.jpltele.com/product/jpl-spitfire/> and chat via **Live Chat** with one of our technical team or email us on support@jpltele.com.



Conditions of Warranty

1. JPL Telecom Limited, Head Office: Units 1 & 2, Church Close Business Park, Church Close, Todber, Sturminster Newton, Dorset DT10 1JH, England, grants 3 year limited manufacturer's warranty* from the date of purchase, as the manufacturer of this product.
2. For you, as a consumer, this means: We guarantee that our devices are error-free when supplied. If a manufacturing error is identified within 36 months* of the delivery date we will repair or replace the device free of charge without you, as the consumer, having to provide the usual legally required proof that this fault was present when you received the device. We either use new parts or parts in mint condition for the repair or replacement delivery. Any parts removed from the device become our property and can be destroyed by us.
3. In addition to this warranty, you have the unlimited legal right to claim against the supplier on the basis of the terms of the warranty for defects on the basis of the purchase contract. However, in contrast to our Manufacturer's Warranty, the legal warranty for defects only applies to the device's state when sold.
4. You can only claim against this warranty if you return the faulty device to JPL Telecom Limited or our local general importer or distributor, outside England, at your own cost, with a valid proof of purchase (invoice or till receipt). When you return it to us, please provide a detailed description of the fault that has occurred, and also tell us your telephone number, in case we need to contact you. To prevent shipping damage, provide suitable transport packaging (e.g. original packaging with a secondary shipping box).
5. The Manufacturer's Warranty excludes damage caused by mishandling, operating errors, misuse, external influences, lightning strikes/power surges, modifications to the product and extensions. Shipping damage, consequential damage, and costs arising from down times and travel times are also excluded.
6. Do not open the camera housing as doing so will void the warranty. The warranty is cancelled if repairs are carried out by unauthorised agents.

*3 years limited warranty (2 years standard repair or replacement warranty plus a 3rd year cover on the camera only)



REGISTERED ADDRESS

UK Office: JPL Telecom Limited

Units 1 & 2, Church Close Business Park, Church Close, Todber, Sturminster Newton, Dorset, DT10 1JH, England

USA Office: JPL Telecom Holdings LLC

445 W Merritt Ave, Merritt Island, FL 32953, USA