

Type 5HF / 5HFP

Quick-acting Fuse Series (High -Breaking Capacity)

HF  5HF/5HFP Series, 5x20mm Ceramic Tube Quick-acting Fuse

RoHS 2 Compliant

Description

5x20mm quick-acting, high breaking capacity, ceramic body cartridge fuse designed, approved and complied with IEC 60127-2, standard sheet 1.



Features

- High breaking capacity (250V ac @ 1500A)
- Meet IEC standard 60127-2, sheet 1
- Wide operating temperature range
- Bulk and Tape & Reel packing available
- RoHS 2 compliant
- Halogen Free
- Lead Free

Applications

Provide individual protection for components or internal circuits.

- Power supplies
- Battery charger
- Monitor
- Adapter

LEAD FREE = 
 HALOGEN FREE = 









Physical Specifications

Materials	Body : Glass
	Cap : Nickel Plated Brass Caps
	Leads : Matte Tin Plated Copper
Marking	On Fuse :
	"bel", "F", "Current Rating", "H", "250V", "Appropriate Safety Logos", "✓" (RoHS 2 compliant)
	On Label :
	"bel", "5HF" or "5HFP", "Current Rating", "Voltage Rating", "Interrupting Rating", "Appropriate Safety Logos" and "✓", "e" (China RoHS compliant).

Electrical Characteristics (IEC-127-2 STANDARD SHEET 1) Safety Agency Approvals

Rated Current	1.5 In		2.1 In		2.75 In		4 In		10 In
	MIN	MAX	MIN	MAX	MIN	MAX	MIN	MAX	MAX
100mA to 3.15A	1	30	10	2	3	300	20		
4A to 6.3A	1	30	10	3	3	300	20		
8A to 12A	1	30	40	20	10	1000	30		
	hr.	min.	ms	sec	ms	ms	ms		

In clause 9.2, the test voltage for 5HFP ratings from 1A to 6.3A is 63VDC.







Safety Agency	Safety Agency Certificate	Voltage Rating (V)	Ampere Range / Volt @ I.R. ability*
	1808556	100mA-10A /250V AC	1A-10A/250V AC@1500A
	40000506		1A-6.3A / 250V AC@1500A
	E20624		100mA-10A/250V AC@1500A
	LR39772		100mA-10A/250V AC@1500A
	JET1037-31003-1008 JET1037-31003-1009		1A-5A/250V AC@1500A
	2002010207021529		100mA-10A/250V AC@1500A

*I.R.= Interrupting Rating = Short Circuit Rating(Amps)

Environmental Specifications

Shock Resistance	MIL-STD-202G, Method 213B, Test Condition 1 (100 G's peak for 6 milliseconds; Sawtooth waveform)
Vibration Resistance	MIL-STD-202G, Method 201A (10-55 Hz, 0.06 inch, total excursion).
Salt Spray Resistance	MIL-STD-202G, Method 101E, Test Condition B (48 hrs).
Insulation Resistance	MIL-STD-202G, Method 302, Test Condition B (After Opening) 100,000 ohms minimum.
Solderability	MIL-STD-202G, Method 208H
Resistance to solder Heat	MIL-STD-202G, Method 210F, Test Condition B. (260+/-5°C, 10+/-1 sec)
Thermal Shock	MIL-STD-202G, Method 107G, Test Condition B (-65°C to +125°C).
Operating Temperature	-55°C to +125°C
Terminal Strength	IEC-68-2-21

Electrical Specifications

Catalog Number	Ampere Rating	Typical Cold Resistance (ohms)	Volt-drop @100%In (Volt) max.	Voltage and Interrupting Ratings	Melting I ² T <10 mSec (A ² Sec)	Melting I ² T @10 In (A ² Sec)	Maximum Power Dissipation (W)	Agency Approvals					
													
5HF(P) 100-R	100mA	3.85	0.55	See Table of Safety Approvals on Page 1 for Voltage and associated Interrupting Ratings	0.003	0.002	0.30	Y	Y	Y			
5HF(P) 125-R	125mA	2.52	0.51		0.005	0.004	0.36	Y	Y	Y			
5HF(P) 160-R	160mA	1.59	0.44		0.009	0.008	0.43	Y	Y	Y			
5HF(P) 200-R	200mA	1.22	0.40		0.016	0.014	0.52	Y	Y	Y			
5HF(P) 250-R	250mA	0.90	0.38		0.028	0.026	0.63	Y	Y	Y			
5HF(P) 315-R	315mA	0.67	0.37		0.05	0.05	0.76	Y	Y	Y			
5HF(P) 400-R	400mA	0.46	0.34		0.09	0.08	0.92	Y	Y	Y			
5HF(P) 500-R	500mA	0.34	0.32		0.16	0.15	1.11	Y	Y	Y			
5HF(P) 630-R	630mA	0.225	0.29		0.29	0.27	1.35	Y	Y	Y			
5HF(P) 800-R	800mA	0.192	0.23		0.36	0.35	0.58	Y	Y	Y			
5HF(P) 1-R	1A	0.139	0.19		0.65	0.63	0.69	Y	Y	Y	Y	Y	Y
5HF(P) 1.25-R	1.25A	0.097	0.17		1.2	1.2	0.81	Y	Y	Y	Y	Y	Y
5HF(P) 1.6-R	1.6A	0.072	0.16		2.1	2.1	0.96	Y	Y	Y	Y	Y	Y
5HF(P) 2-R	2A	0.052	0.14		3.8	3.8	1.1	Y	Y	Y	Y	Y	Y
5HF(P) 2.5-R	2.5A	0.039	0.13		6.8	6.8	1.3	Y	Y	Y	Y	Y	Y
5HF(P) 3.15-R	3.15A	0.029	0.13		12	12	1.6	Y	Y	Y	Y	Y	Y
5HF(P) 4-R	4A	0.022	0.13		22	22	1.9	Y	Y	Y	Y	Y	Y
5HF(P) 5-R	5A	0.016	0.13		39	40	2.2	Y	Y	Y	Y	Y	Y
5HF(P) 6.3-R	6.3A	0.011	0.10		70	73	2.7	Y	Y	Y	Y	Y	
5HF(P) 8-R	8A	0.010	0.11		126	131	3.1	Y	Y	Y	Y		
5HF(P) 10-R	10A	0.007	0.10		227	238	3.7	Y	Y	Y	Y		
5HF(P) 12-R	12A	0.005	0.09		408	430	4.4						

Consult manufacturer for other ratings



Specifications subject to change without notice

Bel Fuse Inc.
206 Van Vorst Street
Jersey City, NJ 07302 USA

+1 201.432.0463
Bel.US.CS@belf.com
belfuse.com/circuit-protection

Temperature Derating Curve

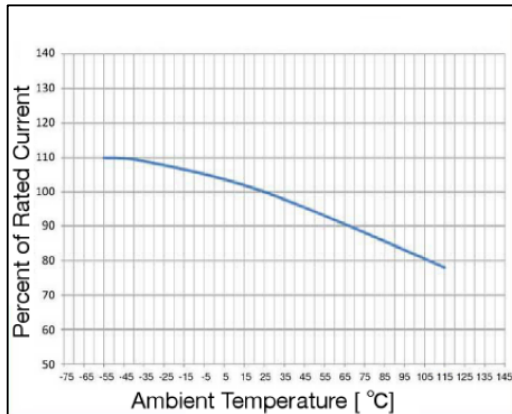

Average Time Current Curve

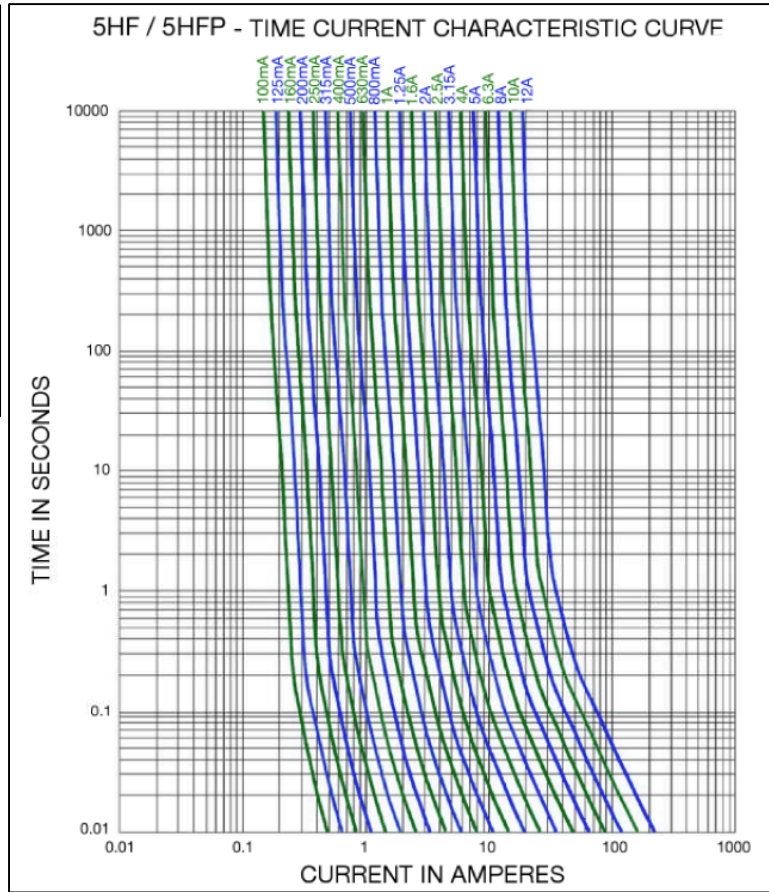

Soldering Parameters

Lead-free Wave Soldering Profile	
Wave Soldering Parameter	
Average ramp-up rate	200°C / second
Heating rate during preheat	typical 1 - 2°C / second Max 4°C / second
Final preheat temperature	within 125°C of soldering temperature
Peak temperature T _p	260°C
Time within +0°C / -5°C of actual peak temperature	10 seconds
Ramp-down rate	5°C / second max.

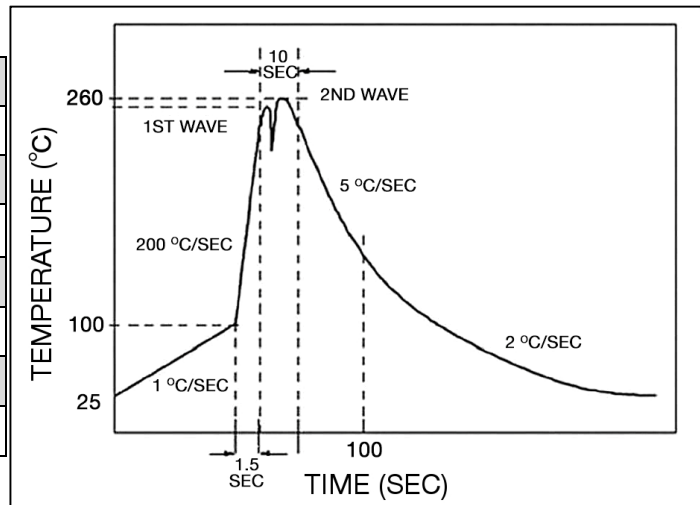

Fuse FGNO Explanation

0650 R [XXXX] -XX

0650R=5HF/5HFP; [XXXX]=Ampere Rating; XX=See Ordering Information as below

Fraction	Decimal	Milliamps	Bel FGNO[XXXX]
1/10	0.100	100	0100
1/8	.125	125	0125
	.160	160	0160
2/10	.200	200	0200
1/4	.250	250	0250
	.315	315	0315
4/10	.400	400	0400
1/2	.500	500	0500
	.630	630	0630
8/10	.800	800	0800

Fraction	Decimal	Amps	Bel FGNO[XXXX]
	1.0	1	1000
1-1/4	1.25	1.25	1250
	1.60	1.6	1600
	2.0	2	2000
2-1/2	2.5	2.5	2500
	3.15	3.15	3150
	4.0	4	4000
	5.0	5	5000
	6.3	6.3	6300
	8.0	8	8000
		10	9100
		12	9120

Mechanical Dimensions

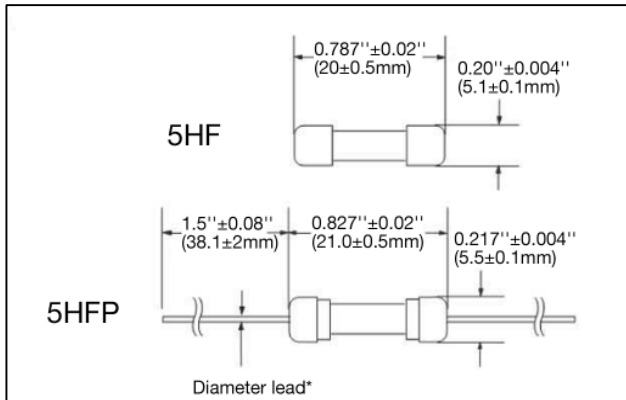

*Ratings 6.3A and less have 0.032" diameter lead;
 *Ratings 8A and above have 0.040" diameter lead.

Ordering Information

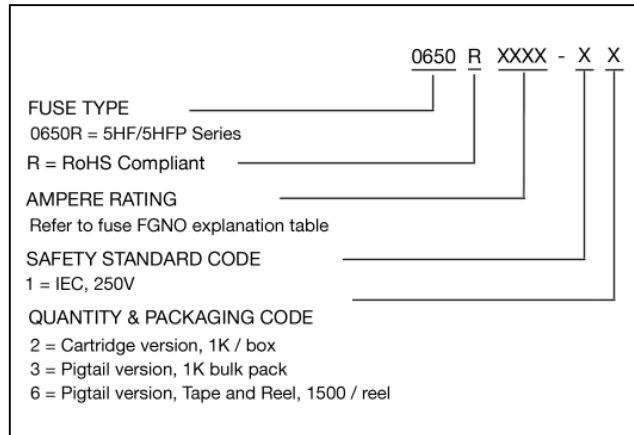

Packaging

Packaging Option	Packaging Specification	Quantity	Packaging Code	Inside Tape Spacing
Bulk	N/A	1000	12	N/A
Bulk (Pigtail Type)	N/A	1000	13	N/A
Tape & Reel, 10mm Pitch	EIA-296-F	1500	16	63