



Is Now Part of



ON Semiconductor®

To learn more about ON Semiconductor, please visit our website at
www.onsemi.com

ON Semiconductor and the ON Semiconductor logo are trademarks of Semiconductor Components Industries, LLC dba ON Semiconductor or its subsidiaries in the United States and/or other countries. ON Semiconductor owns the rights to a number of patents, trademarks, copyrights, trade secrets, and other intellectual property. A listing of ON Semiconductor's product/patent coverage may be accessed at www.onsemi.com/site/pdf/Patent-Marking.pdf. ON Semiconductor reserves the right to make changes without further notice to any products herein. ON Semiconductor makes no warranty, representation or guarantee regarding the suitability of its products for any particular purpose, nor does ON Semiconductor assume any liability arising out of the application or use of any product or circuit, and specifically disclaims any and all liability, including without limitation special, consequential or incidental damages. Buyer is responsible for its products and applications using ON Semiconductor products, including compliance with all laws, regulations and safety requirements or standards, regardless of any support or applications information provided by ON Semiconductor. "Typical" parameters which may be provided in ON Semiconductor data sheets and/or specifications can and do vary in different applications and actual performance may vary over time. All operating parameters, including "Typicals" must be validated for each customer application by customer's technical experts. ON Semiconductor does not convey any license under its patent rights nor the rights of others. ON Semiconductor products are not designed, intended, or authorized for use as a critical component in life support systems or any FDA Class 3 medical devices or medical devices with a same or similar classification in a foreign jurisdiction or any devices intended for implantation in the human body. Should Buyer purchase or use ON Semiconductor products for any such unintended or unauthorized application, Buyer shall indemnify and hold ON Semiconductor and its officers, employees, subsidiaries, affiliates, and distributors harmless against all claims, costs, damages, and expenses, and reasonable attorney fees arising out of, directly or indirectly, any claim of personal injury or death associated with such unintended or unauthorized use, even if such claim alleges that ON Semiconductor was negligent regarding the design or manufacture of the part. ON Semiconductor is an Equal Opportunity/Affirmative Action Employer. This literature is subject to all applicable copyright laws and is not for resale in any manner.

FODM217 Series

Single Channel, DC Sensing Input, Phototransistor Optocoupler In Half-Pitch Mini-Flat 4-Pin Package

The FODM217 Series single channel, DC sensing input, optocoupler consists of one gallium arsenide (GaAs) infrared light emitting diode optically coupled to one phototransistor, in a compact, half-pitch, mini-flat, 4-pin package. The input-output isolation voltage, V_{ISO} , is rated at 3,750 VACRMS.

Features

- Current Transfer Ratio Ranges from 80 to 600% at $I_F = 5\text{ mA}$, $V_{CE} = 5\text{ V}$, $T_A = 25^\circ\text{C}$
 - FODM217A - 80 to 160%
 - FODM217B - 130 to 260%
 - FODM217C - 200 to 400%
 - FODM217D - 300 to 600%
- Safety and Regulatory Approvals:
 - UL1577, 3750 VACRMS for 1 min
 - DIN EN/IEC60747-5-5, 565 V Peak Working Insulation Voltage
- Applicable to Infrared Ray Reflow, 260°C

Typical Applications

- Primarily Suited for DC-DC Converters
- For Ground Loop Isolation, Signal to Noise Isolation
- Communications – Adapters, Chargers
- Consumer – Appliances, Set Top Boxes
- Industrial – Power Supplies, Motor Control, Programmable Logic Control



ON Semiconductor®

www.onsemi.com

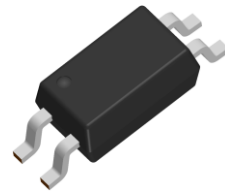

SOP 4 PINS

MARKING DIAGRAM

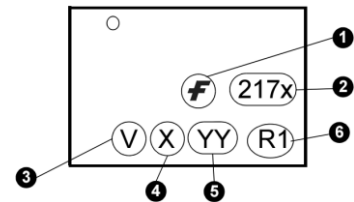

1. F = Corporate Logo
2. 217x = Device Number
3. V = DIN EN/IEC60747-5-5 Option
4. X = One-Digit Year Code
5. YY = Digit Work Week
6. R1 = Assembly Package Code

PIN CONNECTIONS

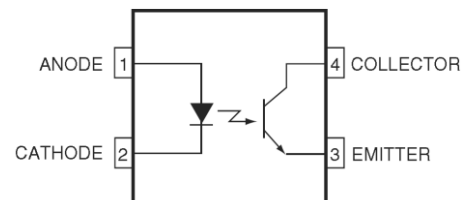

ORDERING INFORMATION

See detailed ordering and shipping information in the package dimensions section on page 9 of this data sheet.

FODM217 Series

SAFETY AND INSULATIONS RATING

As per DIN EN/IEC 60747-5-5, this optocoupler is suitable for "safe electrical insulation" only within the safety limit data. Compliance with the safety ratings shall be ensured by means of protective circuits.

Parameter		Characteristics
Installation Classifications per DIN VDE 0110/1.89 Table 1, For Rated Mains Voltage	< 150 V _{RMS}	I-IV
	< 300 V _{RMS}	I-III
Climatic Classification		55/110/21
Pollution Degree (DIN VDE 0110/1.89)		2
Comparative Tracking Index		175

Symbol	Parameter	Value	Unit
V _{PR}	Input-to-Output Test Voltage, Method A, V _{IORM} × 1.6 = V _{PR} , Type and Sample Test with t _m = 10 s, Partial Discharge < 5 pC	904	V _{peak}
	Input-to-Output Test Voltage, Method B, V _{IORM} × 1.875 = V _{PR} , 100% Production Test with t _m = 1 s, Partial Discharge < 5 pC	1060	V _{peak}
V _{IORM}	Maximum Working Insulation Voltage	565	V _{peak}
V _{IOTM}	Highest Allowable Over-Voltage	4,000	V _{peak}
	External Creepage	≥ 5	mm
	External Clearance	≥ 5	mm
DTI	Distance Through Insulation (Insulation Thickness)	≥ 0.4	mm
T _S	Case Temperature (Note 1)	150	°C
I _{S,INPUT}	Input Current (Note 1)	200	mA
P _{S,OUTPUT}	Output Power (Note 1)	300	mW
R _{IO}	Insulation Resistance at T _S , V _{IO} = 500 V (Note 1)	> 10 ⁹	Ω

1. Safety limit values – maximum values allowed in the event of a failure.

FODM217 Series

ABSOLUTE MAXIMUM RATINGS (Note 2)

$T_A = 25^\circ\text{C}$ unless otherwise specified.

Symbol	Parameter	Value	Units
T_{STG}	Storage Temperature	-55 to +150	$^\circ\text{C}$
T_{OPR}	Operating Temperature	-55 to +110	$^\circ\text{C}$
T_J	Junction Temperature	-55 to +125	$^\circ\text{C}$
T_{SOL}	Lead Solder Temperature (Refer to Reflow Temperature Profile)	260 for 10 sec	$^\circ\text{C}$
Emitter			
$I_{F(average)}$	Continuous Forward Current	50	mA
$I_{F(peak)}$	Peak Forward Current (1 μs pulse, 300 pps)	1	A
V_R	Reverse Input Voltage	6	V
PD_{LED}	Power Dissipation (Note 3)	70	mW
Detector			
$I_{C(average)}$	Continuous Collector Current	50	mA
V_{CEO}	Collector-Emitter Voltage	80	V
V_{ECO}	Emitter-Collector Voltage	7	V
PD_C	Collector Power Dissipation (Note 3)	150	mW

2. Stresses exceeding those listed in the Maximum Ratings table may damage the device. If any of these limits are exceeded, device functionality should not be assumed, damage may occur and reliability may be affected.
3. Functional operation under these conditions is not implied. Permanent damage may occur if the device is subjected to conditions outside these ratings.

FODM217 Series

ELECTRICAL CHARACTERISTICS

T_A = 25°C unless otherwise specified

Symbol	Parameter	Conditions	Min.	Typ.	Max.	Units
Emitter						
V _F	Forward Voltage	I _F = 20 mA		1.2	1.4	V
I _R	Reverse Current	V _R = 4 V			10	μA
C _T	Terminal Capacitance	V = 0 V, f = 1 kHz		30	250	pF
Detector						
BV _{CEO}	Collector-Emitter Breakdown Voltage	I _C = 0.1 mA, I _F = 0 mA	80			V
BV _{ECO}	Emitter-Collector Breakdown Voltage	I _E = 10 μA, I _F = 0 mA	7			V
I _{CEO}	Collector Dark Current	V _{CE} = 50 V, I _F = 0 mA			100	nA

TRANSFER CHARACTERISTICS

T_A = 25°C unless otherwise specified

Symbol	Parameter	Device	Conditions	Min.	Typ.	Max.	Units
CTR _{CE}	Current Transfer Ratio (collector-emitter)	FODM217A	I _F = 5 mA, V _{CE} = 5 V	80		160	%
		FODM217B		130		260	
		FODM217C		200		400	
		FODM217D		300		600	
I _C	Collector Current	All	I _F = 5 mA, V _{CE} = 5 V	4		30	mA
CTR(SAT)	Saturated Current Transfer Ratio	All	I _F = 8 mA, V _{CE} = 0.4 V		60		%
I _{C(SAT)}	Collector Current	All	I _F = 8 mA, V _{CE} = 0.4 V		4.8		mA
V _{CE(SAT)}	Collector-Emitter Saturation Voltage	All	I _F = 8 mA, I _C = 2.4 mA			0.4	V

SWITCHING CHARACTERISTICS

T_A = 25°C unless otherwise specified

Symbol	Parameter	Conditions	Min.	Typ.	Max.	Units
t _{ON}	Turn On Time	I _C = 2 mA, V _{CE} = 10 V, R _L = 100 Ω		3		μs
t _{OFF}	Turn Off Time	I _C = 2 mA, V _{CE} = 10 V, R _L = 100 Ω		3		μs
t _R	Output Rise Time (10% -90%)	I _C = 2 mA, V _{CE} = 10 V, R _L = 100 Ω		2		μs
t _F	Output Fall Time (90% -10%)	I _C = 2 mA, V _{CE} = 10 V, R _L = 100 Ω		3		μs

ISOLATION CHARACTERISTICS

Symbol	Parameter	Conditions	Min.	Typ.	Max.	Units
V _{ISO}	Input-Output Isolation Voltage	Freq = 60 Hz, t = 1.0 min, I _{I-O} ≤ 10 μA (Note 4,5)	3,750			V _{ACRMS}
R _{ISO}	Isolation Resistance	V _{I-O} = 500 V (Note 4)	5 x 10 ¹⁰			Ω
C _{ISO}	Isolation Capacitance	Frequency = 1 MHz		0.6	1.0	pF

4. Device is considered a two terminal device: Pin 1 and 2 are shorted together and Pins 3 and 4 are shorted together.

5. 3,750 V_{ACRMS} for 1 minute duration is equivalent to 4,500 V_{ACRMS} for 1 second duration.

FODM217 Series

TYPICAL CHARACTERISTICS

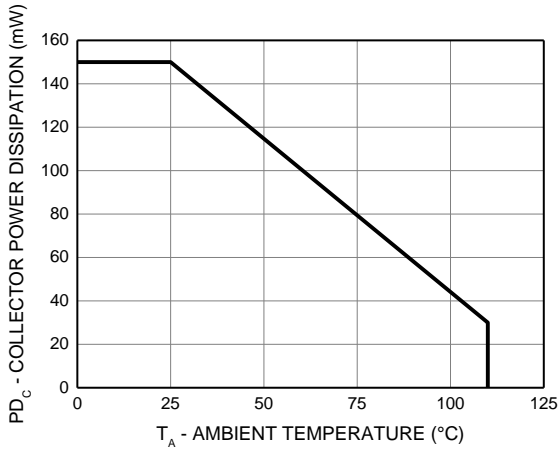

Figure 1. Collector Power Dissipation vs. Ambient Temperature

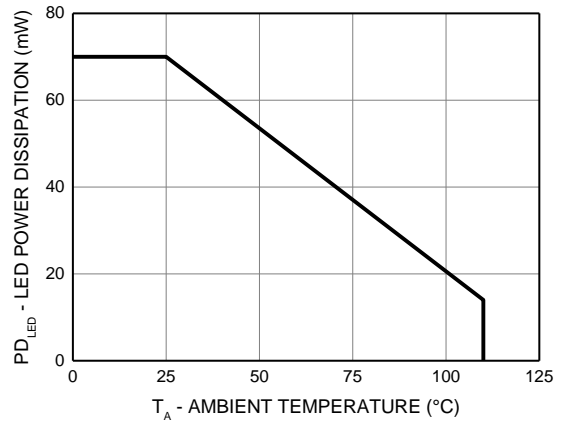

Figure 2. LED Power Dissipation vs. Ambient Temperature

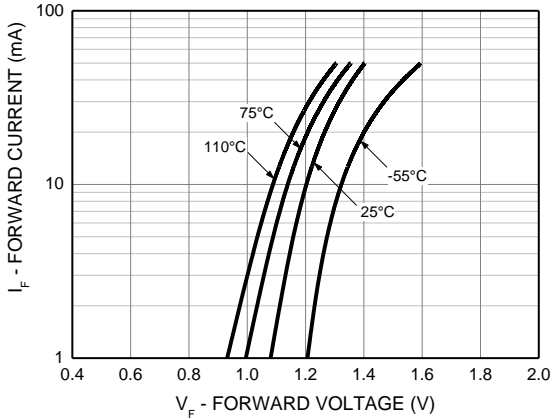

Figure 3. Forward Current vs. Forward Voltage

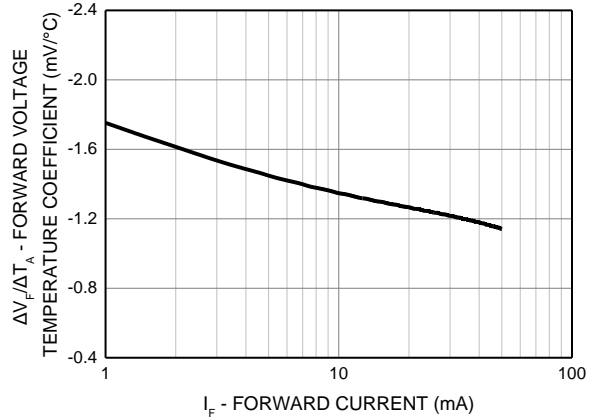

Figure 4. Forward Voltage Temperature Coefficient vs. Forward Current

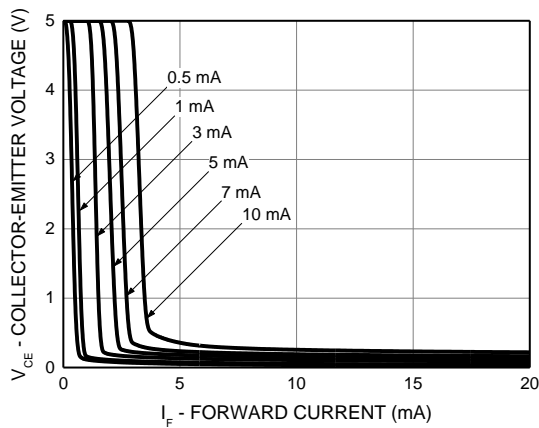

Figure 5. Collector Emitter Voltage vs. Forward Current

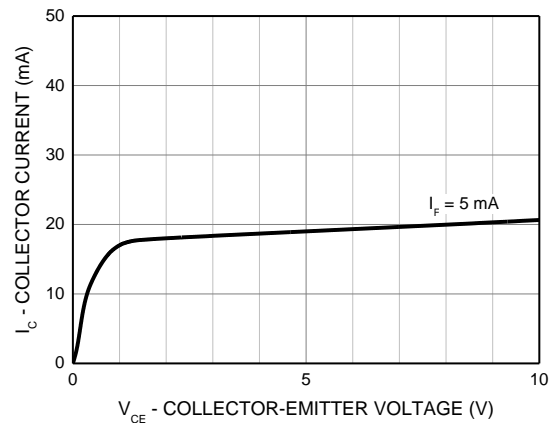

Figure 6. Collector Current vs. Collector-Emitter Voltage

FODM217 Series

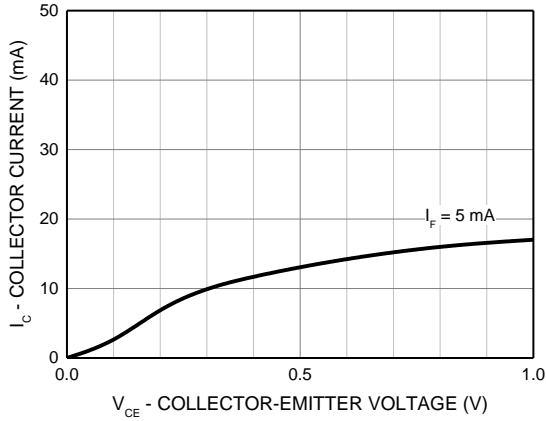

Figure 7. Collector Current vs. Small Collector-Emitter Voltage

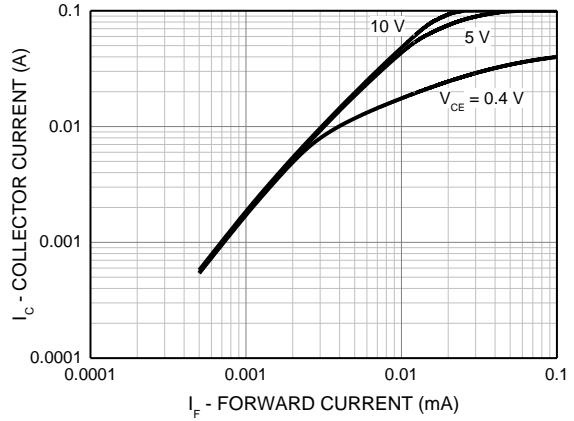

Figure 8. Collector Current vs. Forward Current

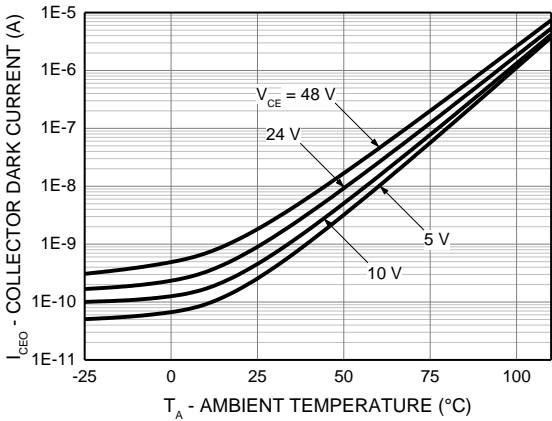

Figure 9. Collector Dark Current vs. Ambient Temperature

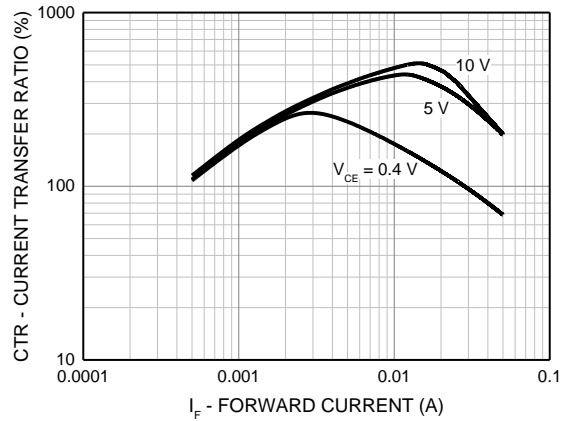

Figure 10. Current Transfer Ratio vs. Forward Current

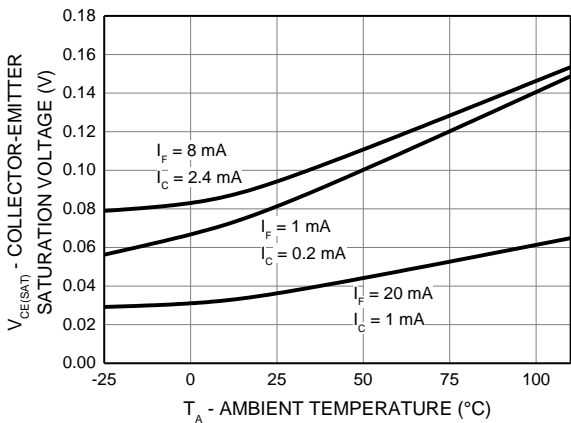

Figure 11. Collector-Emitter Saturation vs. Ambient Temperature

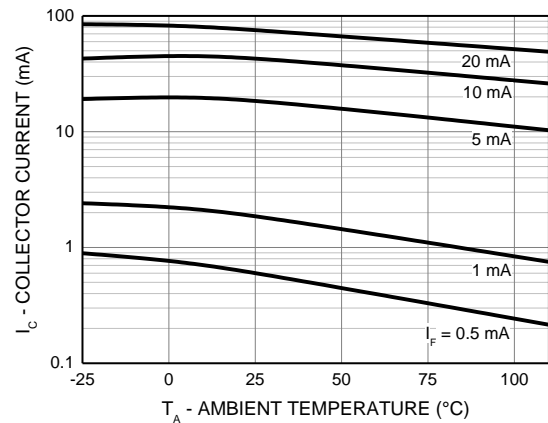

Figure 12. Collector Current vs. Ambient Temperature

FODM217 Series

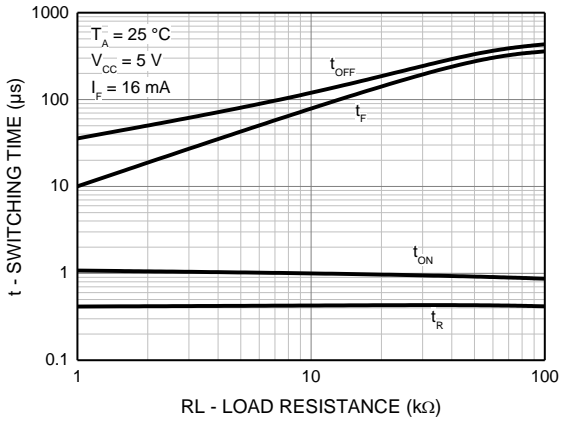

Figure 13. Switching Time vs. Load Resistance

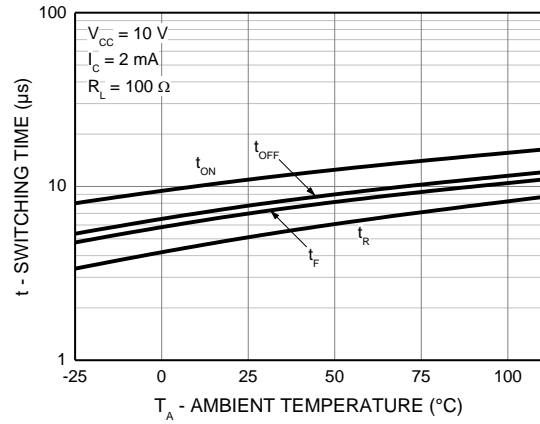

Figure 14. Switching Time vs. Ambient Temperature

TEST CIRCUIT

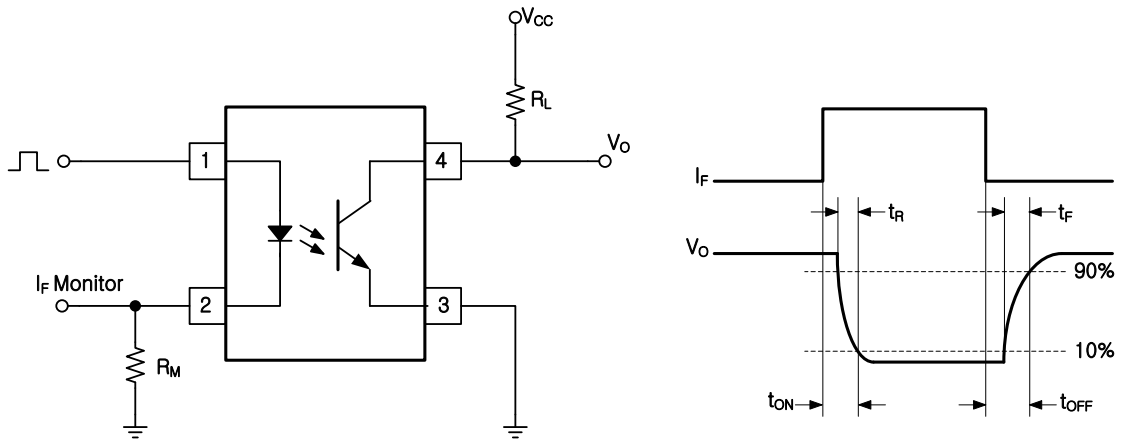
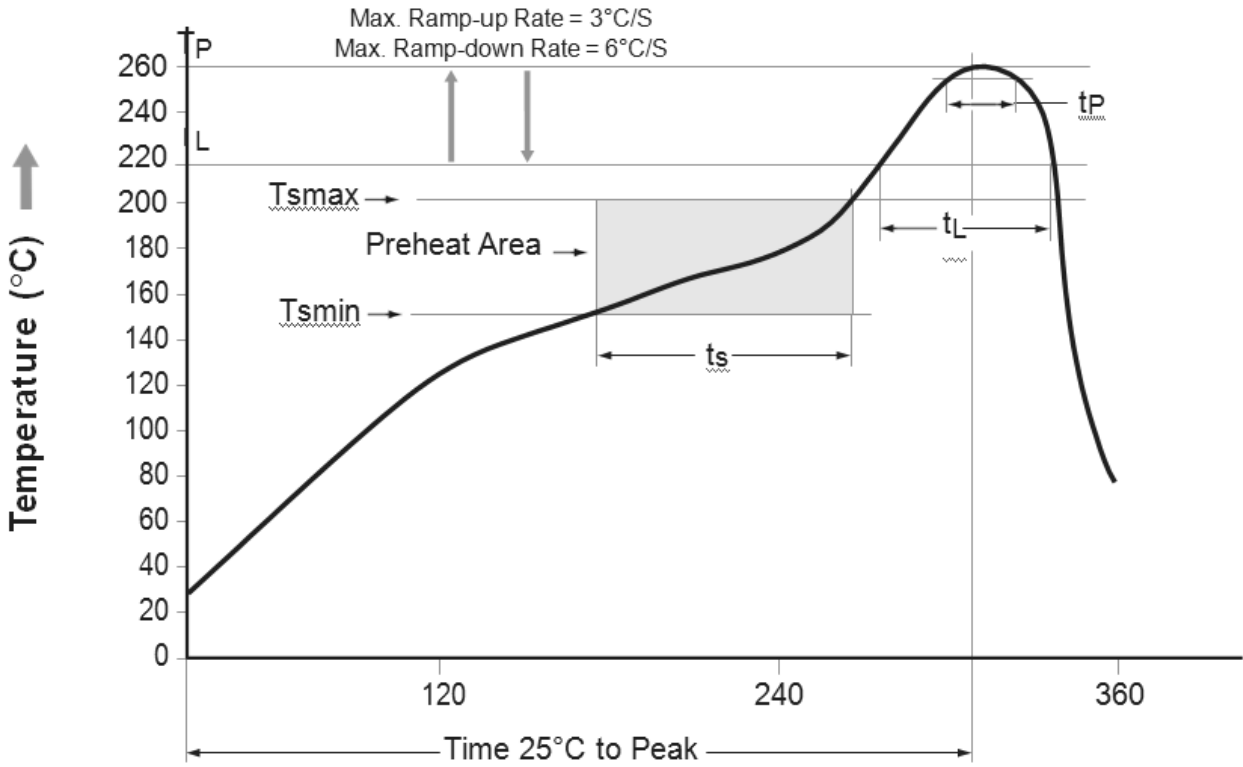

Figure 15. Test Circuit for Switching Time

FODM217 Series

REFLOW PROFILE



Profile Feature	Pb-Free Assembly Profile
Temperature Min. (Tsmín)	150°C
Temperature Max. (Tsmáx)	200°C
Time (ts) from (Tsmín to Tsmáx)	60–120 seconds
Ramp-up Rate (tL to tP)	3°C/second max.
Liquidous Temperature (TL)	217°C
Time (tL) Maintained Above (TL)	60–150 seconds
Peak Body Package Temperature	260°C +0°C / -5°C
Time (tP) within 5°C of 260°C	30 seconds
Ramp-down Rate (TP to TL)	6°C/second max.
Time 25°C to Peak Temperature	8 minutes max.

Figure 36. Reflow Profile

FODM217 Series

ORDERING INFORMATION (Note 6)

Part Number	Package	Packing Method
FODM217A	SOP 4-Pin	Tube (100 units)
FODM217AR2	SOP 4-Pin	Tape and Reel (3000 units)
FODM217AV	SOP 4-Pin, DIN EN/IEC60747-5-5 Option (pending approval)	Tube (100 units)
FODM217AR2V	SOP 4-Pin, DIN EN/IEC60747-5-5 Option (pending approval)	Tape and Reel (3000 units)

6. The product orderable part number system listed in this table also applies to the FODM217B, FODM217C, and FODM217D products.

ON Semiconductor and  are trademarks of Semiconductor Components Industries, LLC dba ON Semiconductor or its subsidiaries in the United States and/or other countries. ON Semiconductor owns the rights to a number of patents, trademarks, copyrights, trade secrets, and other intellectual property. A listing of ON Semiconductor's product/patent coverage may be accessed at www.onsemi.com/site/pdf/Patent-Marking.pdf. ON Semiconductor reserves the right to make changes without further notice to any products herein. ON Semiconductor makes no warranty, representation or guarantee regarding the suitability of its products for any particular purpose, nor does ON Semiconductor assume any liability arising out of the application or use of any product or circuit, and specifically disclaims any and all liability, including without limitation special, consequential or incidental damages. Buyer is responsible for its products and applications using ON Semiconductor products, including compliance with all laws, regulations and safety requirements or standards, regardless of any support or applications information provided by ON Semiconductor. "Typical" parameters which may be provided in ON Semiconductor data sheets and/or specifications can and do vary in different applications and actual performance may vary over time. All operating parameters, including "Typicals" must be validated for each customer application by customer's technical experts. ON Semiconductor does not convey any license under its patent rights nor the rights of others. ON Semiconductor products are not designed, intended, or authorized for use as a critical component in life support systems or any FDA Class 3 medical devices or medical devices with a same or similar classification in a foreign jurisdiction or any devices intended for implantation in the human body. Should Buyer purchase or use ON Semiconductor products for any such unintended or unauthorized application, Buyer shall indemnify and hold ON Semiconductor and its officers, employees, subsidiaries, affiliates, and distributors harmless against all claims, costs, damages, and expenses, and reasonable attorney fees arising out of, directly or indirectly, any claim of personal injury or death associated with such unintended or unauthorized use, even if such claim alleges that ON Semiconductor was negligent regarding the design or manufacture of the part. ON Semiconductor is an Equal Opportunity/Affirmative Action Employer. This literature is subject to all applicable copyright laws and is not for resale in any manner.

PUBLICATION ORDERING INFORMATION

LITERATURE FULFILLMENT:

Literature Distribution Center for ON Semiconductor
19521 E. 32nd Pkwy, Aurora, Colorado 80011 USA
Phone: 303-675-2175 or 800-344-3860 Toll Free USA/Canada
Fax: 303-675-2176 or 800-344-3867 Toll Free USA/Canada
Email: orderlit@onsemi.com

N. American Technical Support: 800-282-9855 Toll Free
USA/Canada
Europe, Middle East and Africa Technical Support:
Phone: 421 33 790 2910
Japan Customer Focus Center
Phone: 81-3-5817-1050

ON Semiconductor Website: www.onsemi.com
Order Literature: <http://www.onsemi.com/orderlit>
For additional information, please contact your local
Sales Representative