

# General Purpose Relay G7L

- Ideally suited for high-inrush fluid pump controls: pool/spa, water processing, emergency, chemical industry, etc.
- High-capacity, high-withstand voltage relay with no contact chattering for momentary voltage drops up to 50% of rated voltage.
- UL Class B construction standard.
- Wide-range AC-activated coil that handles 100 to 120 VAC at either 50 or 60 Hz.
- Miniature hinge for maximum switching capacity, particularly for inductive loads.
- Flame resistant materials (UL94V-0-qualifying) used for all insulation material.
- Quick-connect, screw, and PCB terminals available.
- Standard models are UL, CSA, and TUV approved; VDE/IEC 950 versions are now available. Meet pollution degree 3, Material Group II & III.

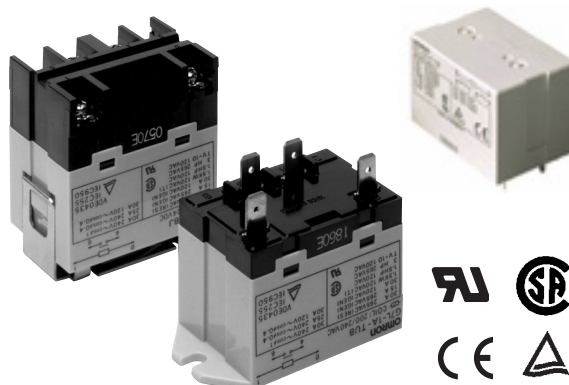

## Ordering Information

To Order: Select the part number and add the desired coil voltage rating (e.g., G7L-1A-T-CB-AC100/120).

Type	Contact form	Model		
		Quick-connect terminal	Screw terminal	PCB terminal
E bracket (see note 1)	SPST-NO	G7L-1A-T-CB	G7L-1A-B-CB	—
	DPST-NO	G7L-2A-T-CB	G7L-2A-B-CB	—
E bracket (see note 1) (with test button)	SPST-NO	G7L-1A-TJ-CB	G7L-1A-BJ-CB	—
	DPST-NO	G7L-2A-TJ-CB	G7L-2A-BJ-CB	—
Upper bracket	SPST-NO	G7L-1A-TUB-CB	G7L-1A-BUB-CB	—
	DPST-NO	G7L-2A-TUB-CB	G7L-2A-BUB-CB	—
Upper bracket (with test button)	SPST-NO	G7L-1A-TUBJ-CB	G7L-1A-BUBJ-CB	—
	DPST-NO	G7L-2A-TUBJ-CB	G7L-2A-BUBJ-CB	—
PCB mounting	SPST-NO	—	—	G7L-1A-P-CB
	DPST-NO	—	—	G7L-2A-P-CB

- Note:** 1. E bracket or socket must be used for mounting (part number R99-07G5D). Refer to “Accessories” section for options and part numbers.  
 2. For VDE approved versions, please consult OMRON.

## Model Number Legend

G7L-□□-□□□□  
1 2 3 4 5 6

- |   |   |  |
|---|---|--|
| <p><b>1. Contact form</b><br/>1A:SPST-NO<br/>2A:DPST-NO</p> <p><b>2. Terminal shape</b><br/>T:Quick-connect terminals<br/>P:PCB terminals<br/>B:Screw terminals</p> | <p><b>3. Mounting construction</b><br/>No symbol:E bracket type<br/>UB:Upper bracket type</p> <p><b>4. Special functions</b><br/>No symbol:Without test button<br/>J:With test button</p> | <p><b>5. 80: VDE approved version</b><br/>(includes UL, CSA and TÜV)</p> <p><b>6. CB: Class B insulation</b></p> <p><b>7. Rated coil voltage</b></p> |
|---|---|--|

## Accessories

### Quick-connect Terminals

Description	Model				Model
	Contact form				
	SPST-NO		DPST-NO		
E-brackets	G7L-1A-T	G7L-1A-TJ	G7L-2A-T	G7L-2A-TJ	R99-07G5D
Track mounting adaptor					P7LF-D
Front connecting socket					P7LF-06

**Note:** A socket terminal cover is supplied with the P7LF-06 socket and does not attach directly to the G7L relays. It cannot be purchased separately.

### Screw Terminals

Description	Model				Model
	Contact form				
	SPST-NO		DPST-NO		
E-brackets	G7L-1A-B	G7L-1A-BJ	G7L-2A-B	G7L-2A-BJ	R99-07G5D
Track mounting adaptor					P7LF-D
Terminal Cover					P7LF-C

**Note:** The P7LF-C terminal cover attaches directly to the G7L-B style relays. It is sold separately.

## Specifications

### Contact Data

Load	G7L-1A-T, G7L-1A-B		G7L-2A-T, G7L-2A-B		G7L-1A-P, G7L-2A-P	
	Resistive load (cosφ = 1)	Inductive load (cosφ = 0.4)	Resistive load (cosφ = 1)	Inductive load (cosφ = 0.4)	Resistive load (cosφ = 1)	Inductive load (cosφ = 0.4)
Rated load	30 A, 220 VAC	25 A, 220 VAC			20 A, 220 VAC	
Contact material	AgSnIn					
Carry current	30 A		25 A		20 A	
Max. operating voltage	250 VAC					
Max. operating current	30 A		25 A		20 A	
Max. switching capacity	6,600 VA	5,500 VA			4,400 VA	
Min. permissible load	100 mA, 5 VDC (please inquire for lower minimum rating)					

**Note:** P level:  $\lambda_{60} = 0.1 \times 10^{-6}$  operation.

### Coil Internal Circuit

DC operating coil

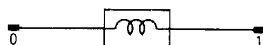

AC operating coil

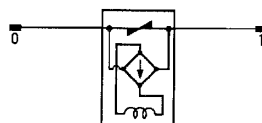

## ■ Coil Data

### AC

Rated voltage (V)	Rated current (mA)	Resistance (Ω)	Must operate	Must release	Max. voltage	Power consumption
			% of rated voltage			
6	283	18.90	75% max.	15% min.	110% max.	Approx. 1.70 to 2.50 VA
12	142	75				
24	71	303				
50	34	1,310				
100/120	17.00/20.40	5,260	75 volts	18 volts	132 volts	
200/240	8.50/10.20	21,000	150 volts	36 volts	264 volts	

### DC

Rated voltage (V)	Rated current (mA)	Resistance (Ω)	Must operate	Must release	Max. voltage	Power consumption
			% of rated voltage			
6	317	18.90	75% max.	15% min.	110% max.	Approx. 1.90 W
12	158	75				
24	79	303				
48	40	1,220				
100	19	5,260				

**Note:** 1. The rated current and coil resistance are measured at a coil temperature of 23°C (73°F) with tolerances of +15%/-20% for AC rated current and ±15% for DC coil resistance.

2. Performance characteristic data are measured at a coil temperature of 23°C (73°F).

## ■ Characteristics

<b>Contact resistance</b>		50 mΩ max.
<b>Operate time</b>		30 ms max.
<b>Release time</b>		30 ms max.
<b>Max. operating frequency</b>	<b>Mechanical</b>	1,800 operations/hour
	<b>Electrical</b>	1,800 operations/hour (under rated load)
<b>Insulation resistance</b>		1,000 MΩ min. (at 500 VDC)
<b>Dielectric strength</b>		4,000 VAC, min./5,000 VAC typical, 50/60 Hz for 1 minute between coil and contacts
		2,000 VAC, 50/60 Hz for 1 minute between contacts of same pole
		2,000 VAC, 50/60 Hz for 1 minute between contacts of different poles (DPST-NO type)
<b>Impulse withstand voltage</b>		Between coil and contact: 10,000 V min./12,000 V typ. (impulse wave used: 1.20 x 50 μs)
<b>Vibration</b>	<b>Mechanical durability</b>	10 to 55 Hz; 1.50 mm (0.06 in) double amplitude
	<b>Malfunction durability</b>	10 to 55 Hz; 1.50 mm (0.06 in) double amplitude
<b>Shock</b>	<b>Mechanical durability</b>	1,000 m/s <sup>2</sup> (approx. 100 G)
	<b>Malfunction durability</b>	1,000 m/s <sup>2</sup> (approx. 10 G)
<b>Life expectancy</b>	<b>Mechanical</b>	1,000,000 operations min. (at 1,800 operations/hour)
	<b>Electrical</b>	100,000 operations min. (at 1,800 operations/hour under rated load 250,000 ops typical)
<b>Ambient temperature</b>		-25° to 60°C (-13° to 140°F)
<b>Humidity</b>		35% to 85% RH
<b>Weight</b>	Quick-connect terminal type: approx. 90 g (3.17 oz)	
	PCB terminal type: approx. 100 g (3.52 oz)	
	Screw terminal type: approx. 120 g (4.23 oz)	

**Note:** Data shown are of initial value.

## Characteristic Data

### Maximum switching capacity

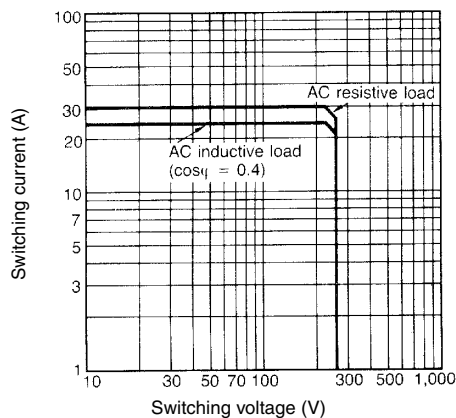

### Electrical service life

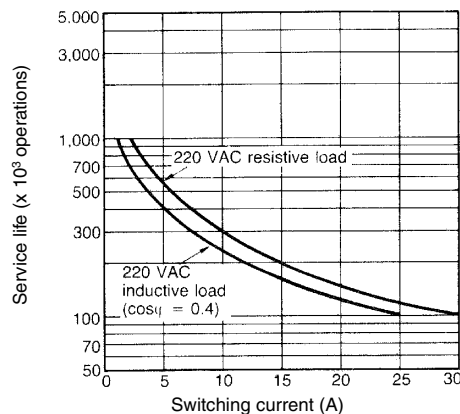

## Dimensions

Unit: mm (inch)

## Relays

### G7L-1A-T (E Bracket Attached)\*

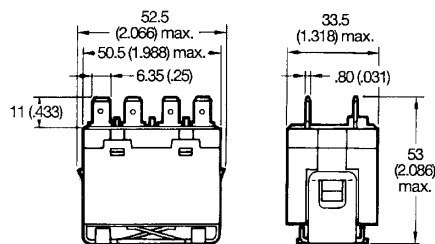

#### Terminal arrangement/ Internal connections (Top view)

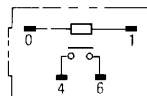

#### Mounting holes (Bottom view)

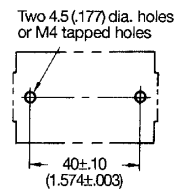

### G7L-2A-T (E Bracket Attached)\*

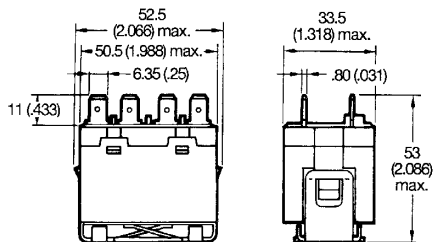

#### Terminal arrangement/ Internal connections (Top view)

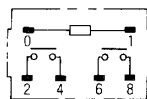

#### Mounting holes (Bottom view)

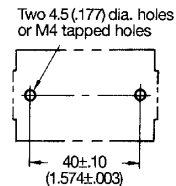

\* E bracket must be ordered separately.

**G7L-1A-TJ  
(E Bracket Attached)\***

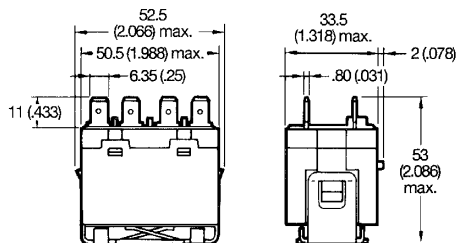

**Terminal arrangement/  
Internal connections  
(Top view)**

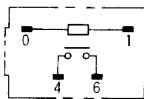

**Mounting holes  
(Bottom view)**

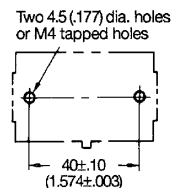

**G7L-2A-TJ  
(E Bracket Attached)\***

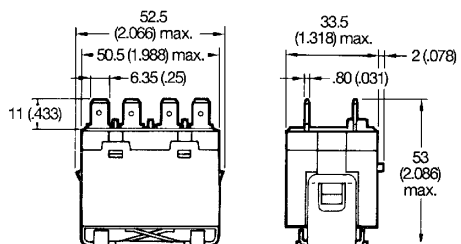

**Terminal arrangement/  
Internal connections  
(Top view)**

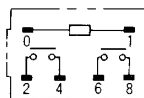

**Mounting holes  
(Bottom view)**

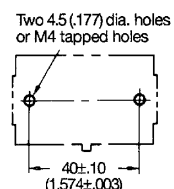

**G7L-1A-TUB**

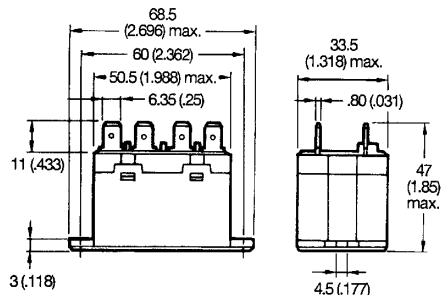

**Terminal arrangement/  
Internal connections  
(Top view)**

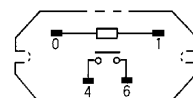

**Mounting holes  
(Bottom view)**

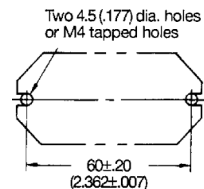

**G7L-2A-TUB**

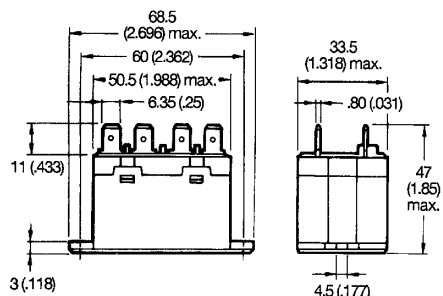

**Terminal arrangement/  
Internal connections  
(Top view)**

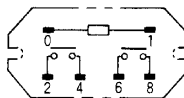

**Mounting holes  
(Bottom view)**

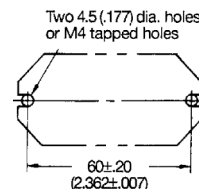

\*E bracket must be ordered separately.

Unit: mm (inch)

**G7L-1A-TUBJ**

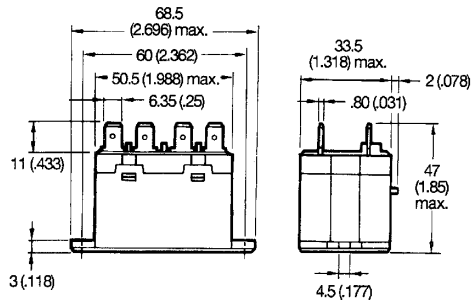

**Terminal arrangement/  
Internal connections  
(Top view)**

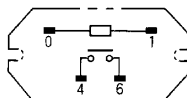

**Mounting holes  
(Bottom view)**

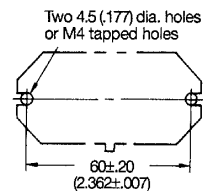

**G7L-2A-TUBJ**

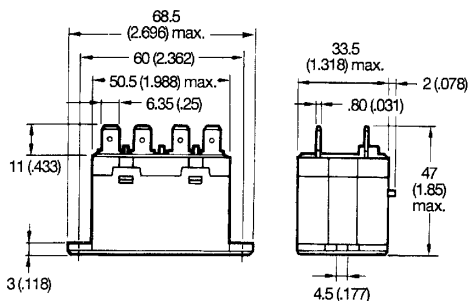

**Terminal arrangement/  
Internal connections  
(Top view)**

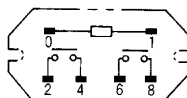

**Mounting holes  
(Bottom view)**

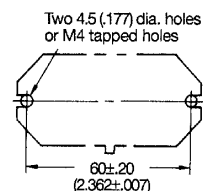

**G7L-1A-B  
(E bracket Attached)\***

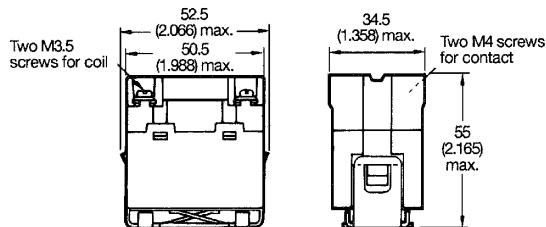

**Terminal arrangement/  
Internal connections  
(Top view)**

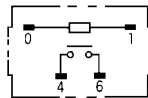

**Mounting holes  
(Bottom view)**

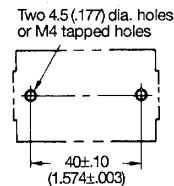

**G7L-2A-B  
(E bracket Attached)\***

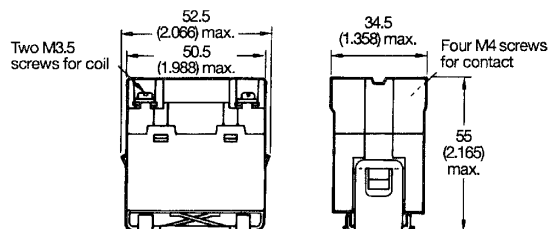

**Terminal arrangement/  
Internal connections  
(Top view)**

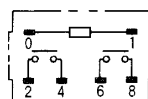

**Mounting holes  
(Bottom view)**

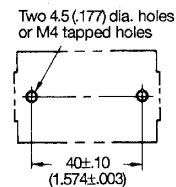

\* E bracket must be ordered separately.

**G7L-1A-BJ**  
**(E bracket Attached)\***

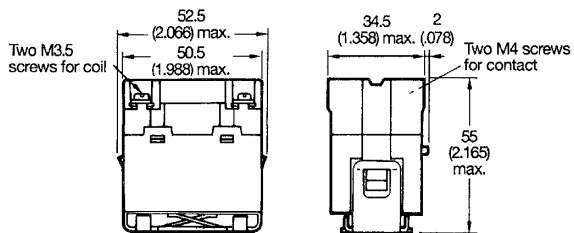

**Terminal arrangement/  
Internal connections**  
(Top view)

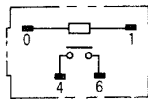

**Mounting holes**  
(Bottom view)

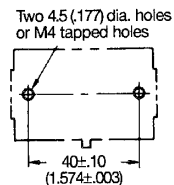

**G7L-2A-BJ**  
**(E bracket Attached)\***

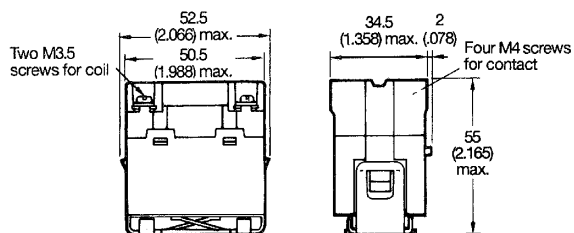

**Terminal arrangement/  
Internal connections**  
(Top view)

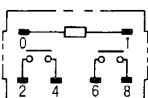

**Mounting holes**  
(Bottom view)

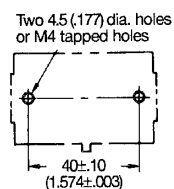

**G7L-1A-BUB**

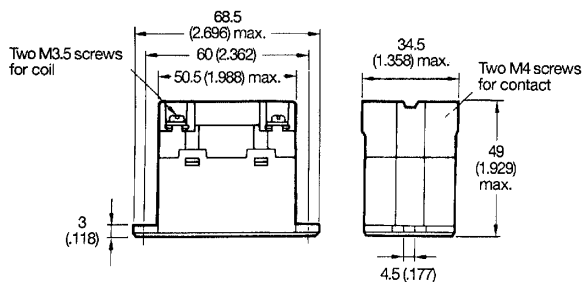

**Terminal arrangement/  
Internal connections**  
(Top view)

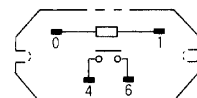

**Mounting holes**  
(Bottom view)

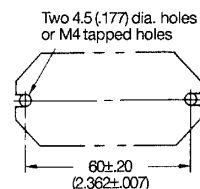

**G7L-2A-BUB**

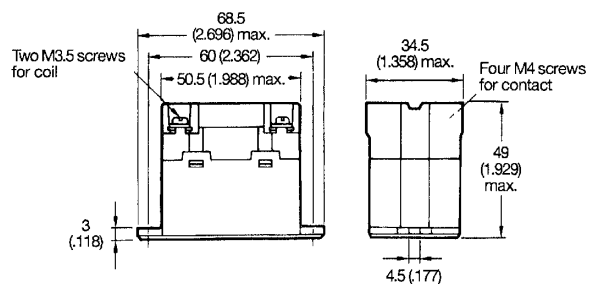

**Terminal arrangement/  
Internal connections**  
(Top view)

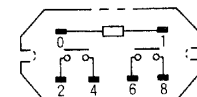

**Mounting holes**  
(Bottom view)

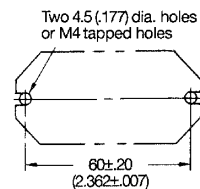

\* E bracket must be ordered separately.

Unit: mm (inch)

**G7L-1A-BUBJ**

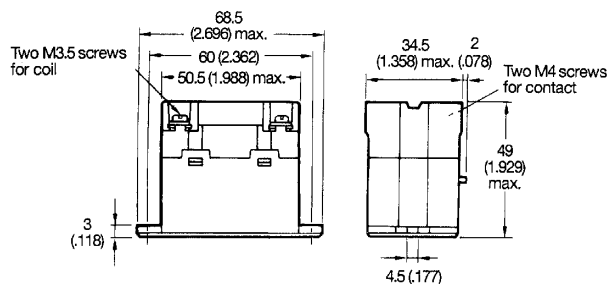

**Terminal arrangement/  
Internal connections  
(Top view)**

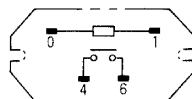

**Mounting holes  
(Bottom view)**

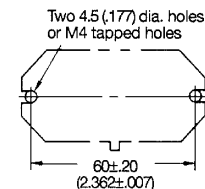

**G7L-2A-BUBJ**

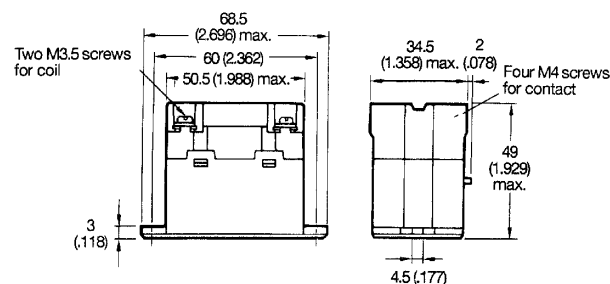

**Terminal arrangement/  
Internal connections  
(Top view)**

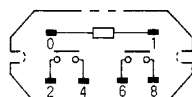

**Mounting holes  
(Bottom view)**

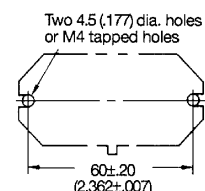

**G7L-1A-P**

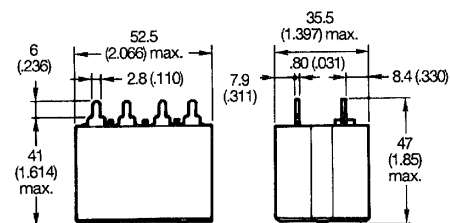

**Terminal arrangement/  
Internal connections  
(Top view)**

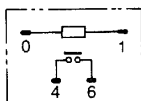

**Mounting holes  
(Bottom view)**

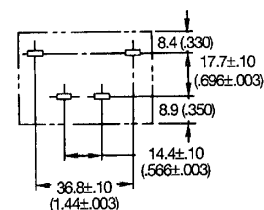

**G7L-2A-P**

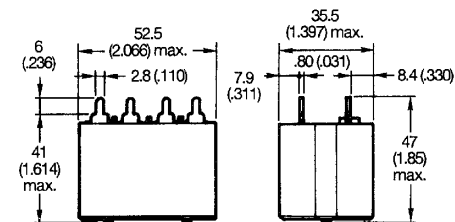

**Terminal arrangement/  
Internal connections  
(Top view)**

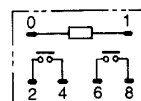

**Mounting holes  
(Bottom view)**

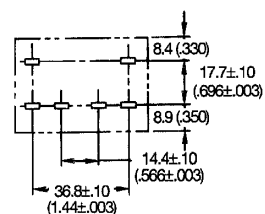



## Accessories

### E bracket R99-07G5D

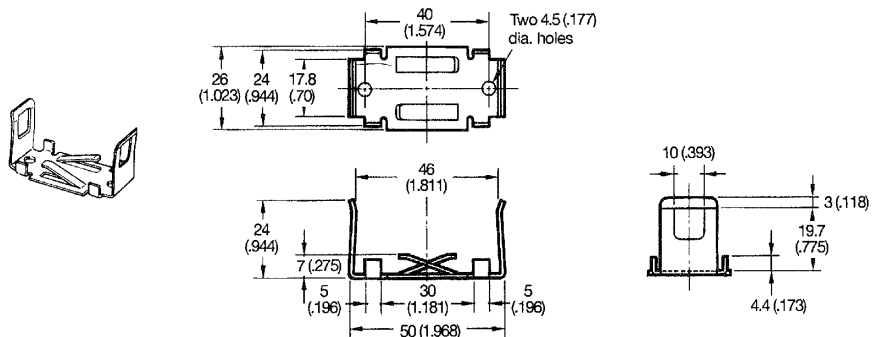

#### Mounting holes (Bottom view)

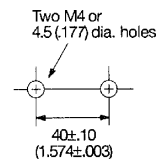

### Adaptor P7LF-D

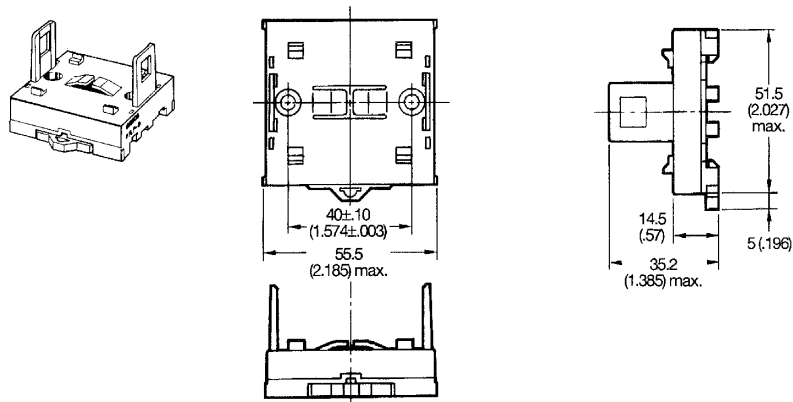

#### Mounting holes (Bottom view)

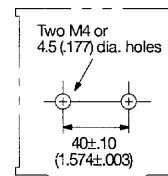

### Front connecting socket P7LF-06

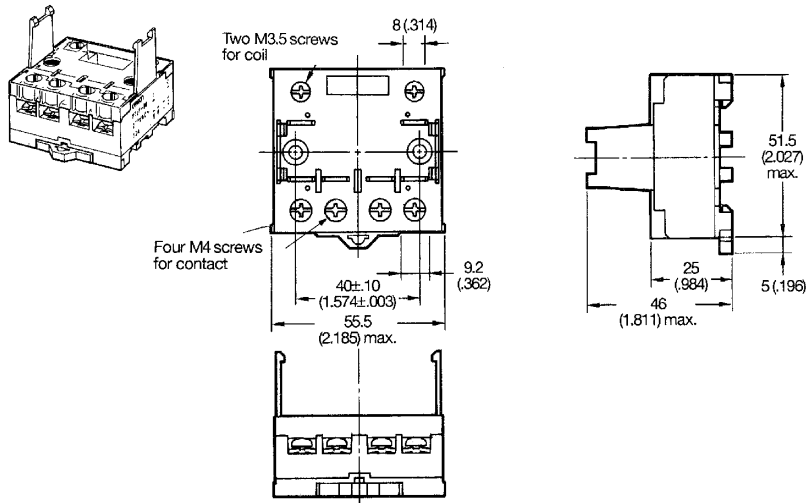

#### Mounting holes (Bottom view)

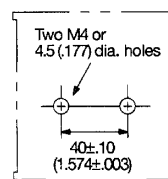

- Note:**
1. To protect against electric shock, a socket terminal cover is supplied with the P7LF-06 socket.
  2. The P7LF-06 is panel or track mountable.

Unit: mm (inch)

**Cover  
P7LF-C**

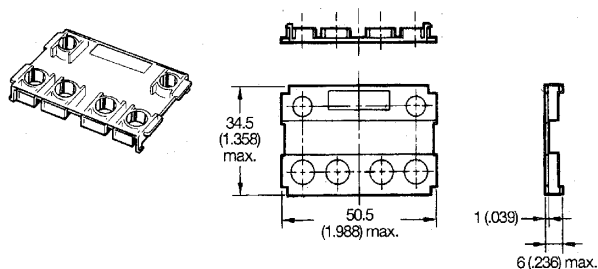

**Note:** P7LF-C cover attaches directly to G7L-B style relays. To protect against electric shock, use the P7LF-C on G7L-B terminals.

**Mounting track**

**PFP-100N, PFP-50N  
(Conforming to EN 50022)**

**PFP-100N2  
(Conforming to EN 50022)**

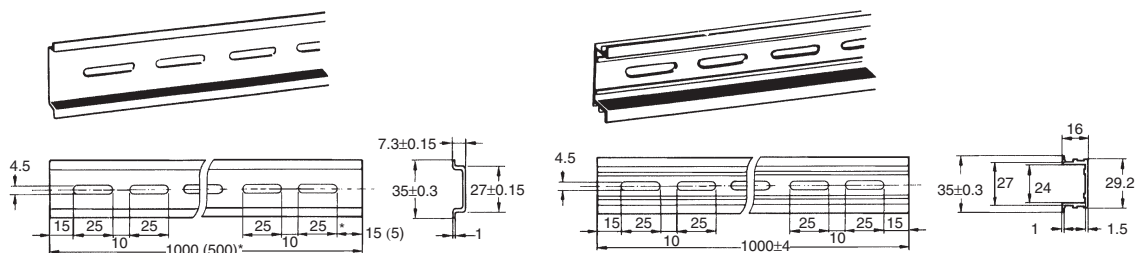

\* The figure in parenthesis is for PFP-50N.

**Note:** 1. It is recommended that a panel thickness of 1.60 to 2.00 mm (0.06 to 0.08 in) be used.

2. L = Length

PFP-100N L = 1 m (39.00 in)

PFP-50N L = 50 cm (19.60 in)

PFP-100N2 L = 1 m (39.00 in)

**End plate**

**PFP-M**

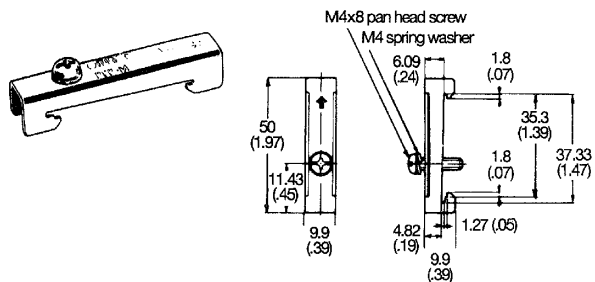

**Spacer**

**PFP-S**

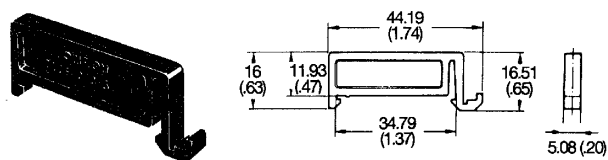

## ■ Approvals

UL Recognized (File No. E41643) / CSA Certified (File No. LR35535) - - Ambient Temp. = 40°C

Type	Contact form	Terminal type	Contact ratings
G7L-1A-T-CB G7L-1A-TJ-CB G7L-1A-TUB-CB G7L-1A-TUBJ-CB	SPST-NO	Quick-connect	30 A, 277 VAC, General Use, 100,000 ops 1.5 kW, 120 VAC, Tungsten, 6,000 ops 1.5 HP, 120 VAC, 6,000 ops 3 HP, 277 VAC, 6,000 ops
G7L-1A-B-CB G7L-1A-BJ-CB G7L-1A-BUB-CB G7L-1A-BUBJ-CB		Screw	20 FLA/120 LRA, 120 VAC, 30,000 ops 17 FLA/102 LRA, 265 VAC, 30,000 ops TV-10, 120 VAC, 25,000 ops
G7L-1A-P-CB		PCB	
G7L-2A-T-CB G7L-2A-TJ-CB G7L-2A-TUB-CB G7L-2A-TUBJ-CB	DPST-NO	Quick-connect	
G7L-2A-B-CB G7L-2A-BJ-CB G7L-2A-BUB-CB G7L-2A-BUBJ-CB		Screw	
G7L-2A-P-CB		PCB	

**Note:** Contact Omron for actual ratings marked on G7L relays

### TÜV (File No. R9251551)

Type	Contact form	Coil ratings	Terminal type	Contact ratings
G7L-1A-T-CB G7L-1A-TJ-CB G7L-1A-TUB-CB G7L-1A-TUBJ-CB	SPST-NO	6, 12, 24, 48, 100, 110, 200, 220 VDC	Quick-connect	25 A, 240 VAC, (cosφ = 1) 25 A, 240 VAC, (cosφ = 0.4)
G7L-1A-B-CB G7L-1A-BJ-CB G7L-1A-BUB-CB G7L-1A-BUBJ-CB			Screw	30 A, 240 VAC, (cosφ = 1) 25 A, 240 VAC, (cosφ = 0.4) 30 A, 240 VAC, (cosφ = 0.4)
G7L-1A-P-CB			PCB	20 A, 240 VAC, (cosφ = 1) 20 A, 240 VAC, (cosφ = 0.4)
G7L-2A-T-CB G7L-2A-TJ-CB G7L-2A-TUB-CB G7L-2A-TUBJ-CB	DPST-NO	12, 24, 50, 100/120, 200/240 VAC	Quick-connect	25 A, 240 VAC, (cosφ = 1) 25 A, 240 VAC, (cosφ = 0.4)
G7L-2A-B-CB G7L-2A-BJ-CB G7L-2A-BUB-CB G7L-2A-BUBJ-CB			Screw	25 A, 240 VAC, (cosφ = 1) 25 A, 240 VAC, (cosφ = 0.4)
G7L-2A-P-CB			PCB	20 A, 240 VAC, (cosφ = 1) 20 A, 240 VAC, (cosφ = 0.4)

### VDE recognized type (Licence no. 1530 UG)

**Note:** 1. Please consult OMRON for details of VDE approvals.

2. The G7L relay conforms to the following standards:

Electrical safety: DIN IEC 255 Teil 1-00/DIN VDE 0435 Teil 201/05. 83  
DIN VDE 0435 Teil 201 A1/05. 90  
DIN IEC 255 Teil 0-20/DIN VDE 0435 Teil 120/10. 81  
DIN EN 60 950/VDE 0805/11. 93

EMC: prEN 50082-2, EN 55022

3. The rated values approved by each of the safety standards (e.g., UL and CSA) may be different from the performance characteristics individually defined in this catalog.

4. In the interest of product improvement, specifications are subject to change.

5. Suffix T130 rated at 130°C

6. Pollution degree 3, Material Group II & III.

# Precautions

## ■ Handling

- To preserve initial performance, do not drop or otherwise subject the power relay to shock.
- The case is not designed to be removed during normal handling and operation. Doing so may affect performance.
- Use the power relay in a dry environment free from excessive dust, SO<sub>2</sub>, H<sub>2</sub>S, or organic gas.
- Do not allow a voltage greater than the maximum allowable coil voltage to be applied continuously.
- Do not use the power relay outside of specified voltages and currents.
- Do not allow the ambient operating temperature to exceed the specified limit.

## ■ Installation

- Although there are not specific limits on the installation site, it should be as dry and dust-free as possible.
- PCB terminal-equipped relays weigh approximately 100 g. Be sure that the PCB is strong enough to support them. We recommend dual-side through-hole PCBs to reduce solder cracking from heat stress.
- Quick-connect terminals can be connected to fast on receptacle #250 and positive-lock connectors.
- Allow suitable slack on leads when wiring, and do not subject the terminals to excessive force.

## ■ Cleaning PCB Terminals

- PCB terminals have semi-sealed construction which prevents flux from entering the relay base. It is recommended that the user should apply a tape seal over the vent hole prior to wave soldering or cleaning. The tape should then be removed after processing.

## ■ Applications

- Compressors for package air conditioners and heater switching controllers
- Switching controllers for power tools or motors
- Power controllers for water heaters
- Power controllers for dryers
- Lamp control, motor drivers, and power supply switching in copy machines, facsimiles, and other OA equipment
- Lighting controllers
- Power controllers for packers or food processing equipment
- Magnetron control in microwaves

## ■ Operating Coil

- As a rule, either a battery or a DC power supply with a maximum 5% ripple is used for the operating voltage for DC relays. Before using a rectified AC supply, confirm that the ripple is not greater than 5%. Ripple greater than this can lead to variations in the operating and reset voltages.

As excessive ripple can generate beats, the insertion of a smoothing capacitor is recommended as shown below.

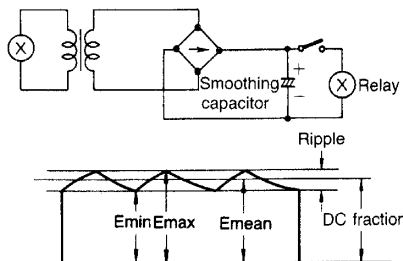

$$\% \text{ of ripple} = \frac{E_{\text{max}} - E_{\text{min}}}{E_{\text{mean}}} \times 100$$

E<sub>max</sub>: Max. ripple  
 E<sub>min</sub>: Min. ripple  
 E<sub>mean</sub>: Mean DC value

- When driving a transistor, check the leakage current and connect a bleeder resistor if necessary.
- Momentary voltage drops on coil input voltage should not exceed one second duration after contact mating with no shock or vibration.

**ALL DIMENSIONS SHOWN ARE IN MILLIMETERS.**

To convert millimeters into inches, multiply by 0.03937. To convert grams into ounces, multiply by 0.03527.

## Read and Understand This Catalog

Please read and understand this catalog before purchasing the products. Please consult your OMRON representative if you have any questions or comments.

## Warranty and Limitations of Liability

### WARRANTY

OMRON's exclusive warranty is that the products are free from defects in materials and workmanship for a period of one year (or other period if specified) from date of sale by OMRON.

OMRON MAKES NO WARRANTY OR REPRESENTATION, EXPRESS OR IMPLIED, REGARDING NON-INFRINGEMENT, MERCHANTABILITY, OR FITNESS FOR PARTICULAR PURPOSE OF THE PRODUCTS. ANY BUYER OR USER ACKNOWLEDGES THAT THE BUYER OR USER ALONE HAS DETERMINED THAT THE PRODUCTS WILL SUITABLY MEET THE REQUIREMENTS OF THEIR INTENDED USE. OMRON DISCLAIMS ALL OTHER WARRANTIES, EXPRESS OR IMPLIED.

### LIMITATIONS OF LIABILITY

OMRON SHALL NOT BE RESPONSIBLE FOR SPECIAL, INDIRECT, OR CONSEQUENTIAL DAMAGES, LOSS OF PROFITS OR COMMERCIAL LOSS IN ANY WAY CONNECTED WITH THE PRODUCTS, WHETHER SUCH CLAIM IS BASED ON CONTRACT, WARRANTY, NEGLIGENCE, OR STRICT LIABILITY.

In no event shall the responsibility of OMRON for any act exceed the individual price of the product on which liability is asserted.

IN NO EVENT SHALL OMRON BE RESPONSIBLE FOR WARRANTY, REPAIR, OR OTHER CLAIMS REGARDING THE PRODUCTS UNLESS OMRON'S ANALYSIS CONFIRMS THAT THE PRODUCTS WERE PROPERLY HANDLED, STORED, INSTALLED, AND MAINTAINED AND NOT SUBJECT TO CONTAMINATION, ABUSE, MISUSE, OR INAPPROPRIATE MODIFICATION OR REPAIR.

## Application Considerations

### SUITABILITY FOR USE

OMRON shall not be responsible for conformity with any standards, codes, or regulations that apply to the combination of products in the customer's application or use of the products.

At the customer's request, OMRON will provide applicable third party certification documents identifying ratings and limitations of use that apply to the products. This information by itself is not sufficient for a complete determination of the suitability of the products in combination with the end product, machine, system, or other application or use.

The following are some examples of applications for which particular attention must be given. This is not intended to be an exhaustive list of all possible uses of the products, nor is it intended to imply that the uses listed may be suitable for the products:

- Outdoor use, uses involving potential chemical contamination or electrical interference, or conditions or uses not described in this catalog.
- Nuclear energy control systems, combustion systems, railroad systems, aviation systems, medical equipment, amusement machines, vehicles, safety equipment, and installations subject to separate industry or government regulations.
- Systems, machines, and equipment that could present a risk to life or property.

Please know and observe all prohibitions of use applicable to the products.

NEVER USE THE PRODUCTS FOR AN APPLICATION INVOLVING SERIOUS RISK TO LIFE OR PROPERTY WITHOUT ENSURING THAT THE SYSTEM AS A WHOLE HAS BEEN DESIGNED TO ADDRESS THE RISKS, AND THAT THE OMRON PRODUCTS ARE PROPERLY RATED AND INSTALLED FOR THE INTENDED USE WITHIN THE OVERALL EQUIPMENT OR SYSTEM.

### PROGRAMMABLE PRODUCTS

OMRON shall not be responsible for the user's programming of a programmable product, or any consequence thereof.

## Disclaimers

### CHANGE IN SPECIFICATIONS

Product specifications and accessories may be changed at any time based on improvements and other reasons.

It is our practice to change model numbers when published ratings or features are changed, or when significant construction changes are made. However, some specifications of the products may be changed without any notice. When in doubt, special model numbers may be assigned to fix or establish key specifications for your application on your request. Please consult with your OMRON representative at any time to confirm actual specifications of purchased products.

### DIMENSIONS AND WEIGHTS

Dimensions and weights are nominal and are not to be used for manufacturing purposes, even when tolerances are shown.

### PERFORMANCE DATA

Performance data given in this catalog is provided as a guide for the user in determining suitability and does not constitute a warranty. It may represent the result of OMRON's test conditions, and the users must correlate it to actual application requirements. Actual performance is subject to the OMRON Warranty and Limitations of Liability.

### ERRORS AND OMISSIONS

The information in this document has been carefully checked and is believed to be accurate; however, no responsibility is assumed for clerical, typographical, or proofreading errors, or omissions.



**OMRON ELECTRONICS LLC • THE AMERICAS HEADQUARTERS** • Schaumburg, IL USA • 847.843.7900 • 800.556.6766 • [www.omron247.com](http://www.omron247.com)

**OMRON CANADA, INC. • HEAD OFFICE**

Toronto, ON, Canada • 416.286.6465 • 866.986.6766  
[www.omron247.com](http://www.omron247.com)

**OMRON ELETRÔNICA DO BRASIL LTDA • HEAD OFFICE**

São Paulo, SP, Brasil • 55.11.2101.6300 • [www.omron.com.br](http://www.omron.com.br)

**OMRON ELECTRONICS MEXICO SA DE CV • HEAD OFFICE**

Apodaca, N.L. • 52.811.156.99.10 • 001.800.556.6766 • [mela@omron.com](mailto:mela@omron.com)

**OMRON ARGENTINA • SALES OFFICE**

Cono Sur • 54.11.4783.5300

**OMRON CHILE • SALES OFFICE**

Santiago • 56.9.9917.3920

**OTHER OMRON LATIN AMERICA SALES**

54.11.4783.5300

**OMRON EUROPE B.V.** Wegalaan 67-69, NL-2132 JD, Hoofddorp, The Netherlands. Tel: +31 (0) 23 568 13 00 Fax: +31 (0) 23 568 13 88 [www.industrial.omron.eu](http://www.industrial.omron.eu)