

PLEASE CHECK WWW.MOLEX.COM FOR LATEST PART INFORMATION

Part Number: [2035551012](#)
Status: **Active**
Overview: CP Wire-to-Board and Wire-to-Wire Connector Systems
Description: CP-6.5 Header, 6.50mm Pitch, Dual Row, Right-Angle, Polarized, Through Hole, Tube Packaging, 2 Circuits, Red

Documents:

3D Model	Packaging Specification 2035550001-PK-000 (PDF)
Drawing (PDF)	Test Summary 2035550001-TS-000 (PDF)
Product Specification 2035550001-PS-000 (PDF)	RoHS Certificate of Compliance (PDF)

Agency Certification

UL E29179

General

Product Family	PCB Headers
Series	203555
Application	Power, Wire-to-Board
CURRENT-MAX-NUMERIC	11.8
Comments	See Product Specification for maximum current rating by circuit size and wire AWG, See Product Specification for maximum current rating by circuit size and wire AWG
Datasheet Order No	987651-1601
Overview	CP Wire-to-Board and Wire-to-Wire Connector Systems
PITCH-MATING-NUMERIC	6.50
Product Name	CP-6.5
UPC	191130537020

Physical

Breakaway	No
Circuits (Loaded)	2
Circuits (maximum)	2
Color - Resin	Red
Durability (mating cycles max)	30
First Mate / Last Break	No
Flammability	94V-0
Glow-Wire Capable	No
Guide to Mating Part	No
Keying to Mating Part	Yes
Lock to Mating Part	Yes
Material - Metal	Copper Alloy
Material - Plating Mating	Matte Tin
Material - Plating Termination	Matte Tin
Material - Resin	Nylon
Net Weight	1.940/g
Number of Rows	2
Orientation	Right Angle
PC Tail Length	3.81mm
PCB Locator	Yes
PCB Retention	Yes
PCB Thickness - Recommended	1.60mm
Packaging Type	Tube
Pitch - Mating Interface	6.50mm
Pitch - Termination Interface	6.50mm
Plating min - Mating	1.270µm
Plating min - Termination	1.270µm
Polarized to Mating Part	Yes

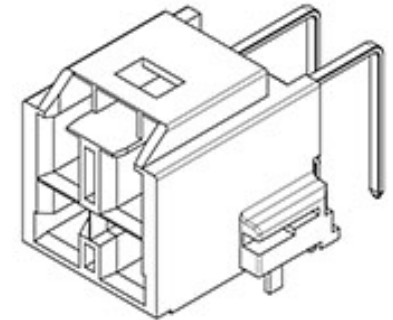

Series image - Reference only

EU ELV

Not Relevant

EU RoHS

Compliant

REACH SVHC

Not Contained Per
-ED/88/2018 (15
January 2019)

Halogen-Free

Status

Not Low-Halogen

For more information, please visit [Contact US](#)

China ROHS

ELV

RoHS Phthalates

China RoHS

Green Image

Not Relevant

Not Contained

Search Parts in this Series

[203555 Series](#)

Mates With

CP-6.5 Receptacle Housing [1512072209](#)

Polarized to PCB	Yes
Temperature Range - Operating	-40° to +105°C
Termination Interface: Style	Through Hole

Electrical

Current - Maximum per Contact	11.8A
Voltage - Maximum	600V AC (RMS)/DC

Material Info

Reference - Drawing Numbers

Packaging Specification	2035550001-PK-000
Product Specification	2035550001-PS-000
Sales Drawing	2035551000-SD-000
Test Summary	2035550001-TS-000

This document was generated on 08/05/2019

PLEASE CHECK WWW.MOLEX.COM FOR LATEST PART INFORMATION