

Flush-type female connector - SACC-CI-M12FS-8CON-L180-10G



1402457

<https://www.phoenixcontact.com/gb/products/1402457>

Please be informed that the data shown in this PDF document is generated from our Online Catalog. Please find the complete data in the user documentation. Our General Terms of Use for Downloads are valid.

Cat6_A flush-type socket, Ethernet, 8-pos., rear mounting, with straight solder connection



Your advantages

- Reduced mounting costs thanks to two-piece device connector
- Packaging available for automated pick and place assembly
- All common pin assignments and codings available
- Easy device integration thanks to mechanical port screw connections with threaded attachment, press-in contour or direct integration in the front plate
- Compatible with connectors with screw or push-in connection

Commercial Data

Item number	1402457
Packing unit	20 pc
Minimum order quantity	20 pc
Sales Key	ABQCBF
Product Key	ABQCBF
Catalog Page	Page 90 (C-2-2013)
GTIN	4046356615907
Weight per Piece (including packing)	4.657 g
Weight per Piece (excluding packing)	3.9 g
Customs tariff number	85366990
Country of origin	DE

Flush-type female connector - SACC-CI-M12FS-8CON-L180-10G



1402457

<https://www.phoenixcontact.com/gb/products/1402457>

Technical Data

Notes

Notes on operation	The electrical and mechanical data specified assume that the connector pair is correctly locked and mounted. If the connector is unlocked and if there is a danger of contamination, the connector must be sealed using a protective cap > IP54. Influences arising from litz wires, cables or PCB assembly must also be taken into consideration.
--------------------	--

Product properties

Product type	Contact insert
Number of positions	8
Shielded	yes
Coding	X - data

Insulation characteristics

Overvoltage category	III
Degree of pollution	3

Electrical properties

Rated surge voltage	1.5 kV
Contact resistance	≤ 5 mΩ
Insulation resistance	> 100 MΩ
Nominal voltage U _N	50 V AC 60 V DC
Nominal current I _N	0.5 A

Interfaces

Signal type/category	Ethernet CAT6 _A
----------------------	----------------------------

Material specifications

Material	Zinc die-cast (nickel-plated)
Flammability rating according to UL 94	V0
Contact material	Copper alloy
Contact surface material	Gold
Contact carrier material	PPA

Connector

Insertion/withdrawal cycles	> 100
-----------------------------	-------

Connection 1

Head design	Socket
Head cable outlet	straight
Head thread type	M12

Flush-type female connector - SACC-CI-M12FS-8CON-L180-10G



1402457

<https://www.phoenixcontact.com/gb/products/1402457>

Coding	X - data
--------	----------

Cable / line

Signal type/category	Ethernet CAT6 _A
----------------------	----------------------------

Environmental and real-life conditions

Ambient conditions

Degree of protection (when plugged in)	IP67 (correctly plugged in and locked)
Degree of protection	IP67 (correctly plugged in and locked)
Degree of protection	IP67, when plugged in
Ambient temperature (operation)	-40 °C ... 90 °C

Standards and regulations

M12

Standards/specifications	IEC 61076-2-109
--------------------------	-----------------

Mounting

Mounting type	PCB mounting
---------------	--------------

Packaging specifications

Type of packaging	Blister
-------------------	---------

Flush-type female connector - SACC-CI-M12FS-8CON-L180-10G

1402457

<https://www.phoenixcontact.com/gb/products/1402457>

Drawings

Drilling plan/solder pad geometry

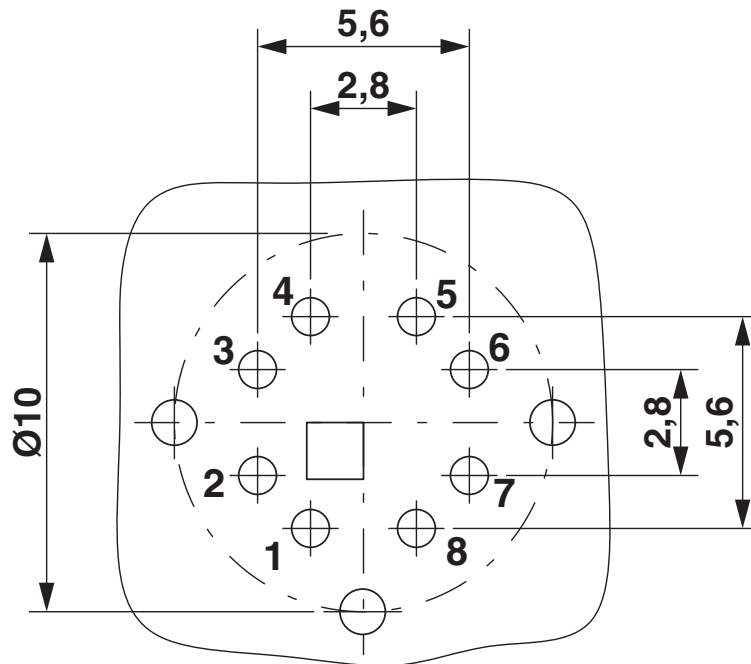

Soldering pad geometry

Dimensional drawing

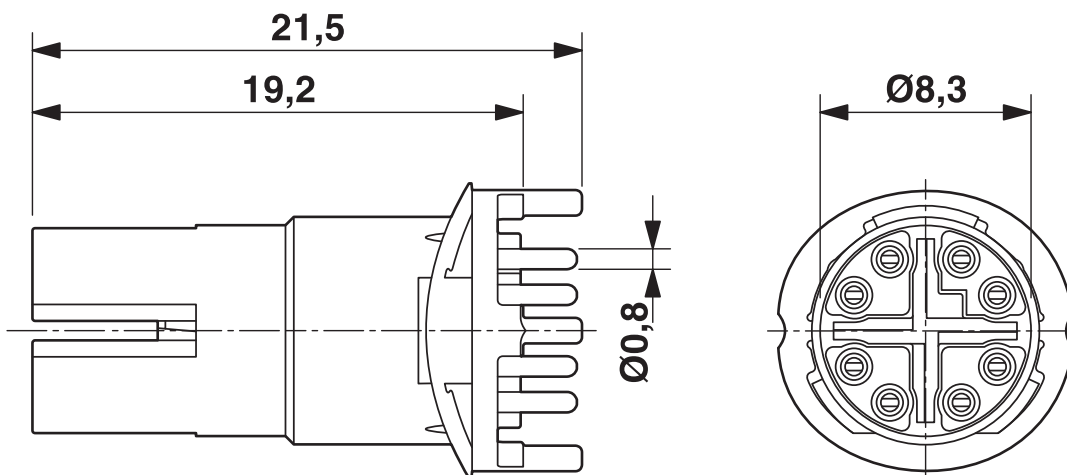

M12 female connector contact carrier

Flush-type female connector - SACC-CI-M12FS-8CON-L180-10G

1402457

<https://www.phoenixcontact.com/gb/products/1402457>

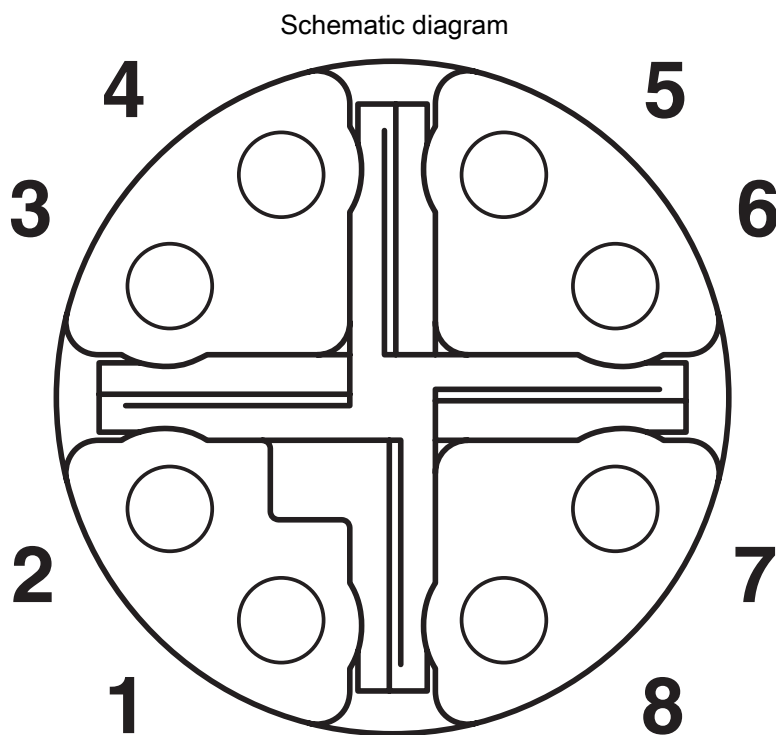

Pin assignment M12 connector, 8-pos., view socket side

Flush-type female connector - SACC-CI-M12FS-8CON-L180-10G





1402457

<https://www.phoenixcontact.com/gb/products/1402457>

Approvals

	cUL Recognized Approval ID: E335024-20120308				
	Nominal Voltage U_N	Nominal Current I_N	Cross Section AWG	Cross Section mm^2	
	60 V	0.5 A	-	-	

	UL Recognized Approval ID: E335024-20120308				
	Nominal Voltage U_N	Nominal Current I_N	Cross Section AWG	Cross Section mm^2	
	60 V	0.5 A	-	-	

	EAC Approval ID: B.01687				
---	------------------------------------	--	--	--	--

cULus Recognized					
-------------------------	--	--	--	--	--

Flush-type female connector - SACC-CI-M12FS-8CON-L180-10G



1402457

<https://www.phoenixcontact.com/gb/products/1402457>

Classifications

ECLASS

ECLASS-9.0	27440102
ECLASS-10.0.1	27440102
ECLASS-11.0	27440102

ETIM

ETIM 8.0	EC002635
----------	----------

UNSPSC

UNSPSC 21.0	39121400
-------------	----------

Flush-type female connector - SACC-CI-M12FS-8CON-L180-10G



1402457

<https://www.phoenixcontact.com/gb/products/1402457>

Environmental Product Compliance

REACH SVHC	Lead 7439-92-1
China RoHS	Environmentally Friendly Use Period = 50 years
	For information on hazardous substances, refer to the manufacturer's declaration available under "Downloads"

Flush-type female connector - SACC-CI-M12FS-8CON-L180-10G

1402457

<https://www.phoenixcontact.com/gb/products/1402457>

Accessories

Sample set

Sample set - SACC-CIM12FSX8CONL180THRSAMPLE - 1422992

<https://www.phoenixcontact.com/gb/products/1422992>



Cat6_A flush-type socket, Ethernet, 8-pos., rear mounting, with straight solder connection

Housing screw connection

Housing screw connection - SACC-M12-SCO NUT - 1552243

<https://www.phoenixcontact.com/gb/products/1552243>



Housing screw connection, Socket, M12-SPEEDCON, Front mounting, M12 x 1, Alternative product in accordance with RoHS II without Exemption 6c (Pb <0.1%) 1237399

Flush-type female connector - SACC-CI-M12FS-8CON-L180-10G

1402457

<https://www.phoenixcontact.com/gb/products/1402457>

Device connector front mounting

Device connector front mounting - SACC-DSIV-M12-NUT - 1416144

<https://www.phoenixcontact.com/gb/products/1416144>



Housing screw connection with M12 standard thread, with O-ring, for the two-piece straight M12 THR contact carrier and for the two-piece angled M12 contact carrier

Housing screw connection

Housing screw connection - SACC-M12-SCO NUT L 90 - 1432460

<https://www.phoenixcontact.com/gb/products/1432460>



Housing screw connection, M12 x 1, Alternative product in accordance with RoHS II without Exemption 6c (Pb <0.1%) 1237409

Flush-type female connector - SACC-CI-M12FS-8CON-L180-10G

1402457

<https://www.phoenixcontact.com/gb/products/1402457>

Housing screw connection

Housing screw connection - SACC-BP-F-M12/M15-6-THR - 1414004

<https://www.phoenixcontact.com/gb/products/1414004>



Housing screw connection, Socket, M12, Rear mounting, M15 x 1, Alternative product in accordance with RoHS II without Exemption 6c (Pb <0.1%) 1239056

Housing screw connection

Housing screw connection - SACC-BP-F-M12/M15-7-THR - 1414003

<https://www.phoenixcontact.com/gb/products/1414003>



Housing screw connection, Socket, M12, Rear mounting, M15 x 1, Alternative product in accordance with RoHS II without Exemption 6c (Pb <0.1%) 1239055

Flush-type female connector - SACC-CI-M12FS-8CON-L180-10G

1402457

<https://www.phoenixcontact.com/gb/products/1402457>

Housing screw connection

Housing screw connection - SACC-BP-F-M12/M15-6-THR SCO - 1414020

<https://www.phoenixcontact.com/gb/products/1414020>



Housing screw connection, Socket, M12-SPEEDCON, Rear mounting, M15 x 1, Alternative product in accordance with RoHS II without Exemption 6c (Pb <0.1%) 1239057

Housing screw connection

Housing screw connection - SACC-BP-F-M12/M15-7-THR SCO - 1414005

<https://www.phoenixcontact.com/gb/products/1414005>



Housing screw connection, Socket, M12-SPEEDCON, Rear mounting, M15 x 1, Alternative product in accordance with RoHS II without Exemption 6c (Pb <0.1%) 1237398

Flush-type female connector - SACC-CI-M12FS-8CON-L180-10G

1402457

<https://www.phoenixcontact.com/gb/products/1402457>

Housing screw connection

Housing screw connection - SACC-BP-F-M12/THR-1,0/1,8-9TIP - 1419630

<https://www.phoenixcontact.com/gb/products/1419630>



M12 threaded sleeve with tolerance-compensating function, for straight, THR solderable M12 socket contact inserts. Suitable for 1.0 mm ... 1.8 mm thick front plates.

Housing screw connection

Housing screw connection - SACC-BP-F-M12/THR-1,7/2,5-9TIP - 1419631

<https://www.phoenixcontact.com/gb/products/1419631>



M12 threaded sleeve with tolerance-compensating function, for straight, THR solderable M12 socket contact inserts. Suitable for 1.7 mm ... 2.5 mm thick front plates.

Flush-type female connector - SACC-CI-M12FS-8CON-L180-10G

1402457

<https://www.phoenixcontact.com/gb/products/1402457>

Housing screw connection

Housing screw connection - SACC-BP-F-M12/THR-2,4/3,2-9TIP - 1419633

<https://www.phoenixcontact.com/gb/products/1419633>



M12 threaded sleeve with tolerance-compensating function, for straight, THR solderable M12 socket contact inserts. Suitable for 2.4 mm ... 3.2 mm thick front plates.

Housing screw connection

Housing screw connection - SACC-BP-F-M12/THR-3,1/3,9-9TIP - 1419634

<https://www.phoenixcontact.com/gb/products/1419634>



M12 threaded sleeve with tolerance-compensating function, for straight, THR solderable M12 socket contact inserts. Suitable for 3.1 mm ... 3.9 mm thick front plates.

Flush-type female connector - SACC-CI-M12FS-8CON-L180-10G

1402457

<https://www.phoenixcontact.com/gb/products/1402457>

Housing screw connection

Housing screw connection - SACC-M12 NUT PRESS - 1437889

<https://www.phoenixcontact.com/gb/products/1437889>



Housing screw connection, Socket, M12, M12 x 1, Alternative product in accordance with RoHS II without Exemption 6c (Pb <0.1%) 1237410

Device connector front mounting

Device connector front mounting - SACC-DSIV-M12-NUT-9 THR - 1417989

<https://www.phoenixcontact.com/gb/products/1417989>



M12 female connector, front mounting THR with M14 screw fastening

Flush-type female connector - SACC-CI-M12FS-8CON-L180-10G



1402457

<https://www.phoenixcontact.com/gb/products/1402457>

Housing screw connection

Housing screw connection - SACC-BP-F-M12-THR PP - 1027662

<https://www.phoenixcontact.com/gb/products/1027662>



Housing screw connection, Socket, M12-Push-Pull, Rear mounting, M16, THR- und Wellenlötkontakte

Housing screw connection

Housing screw connection - SACC-FP-F-M12-THR PP - 1027678

<https://www.phoenixcontact.com/gb/products/1027678>

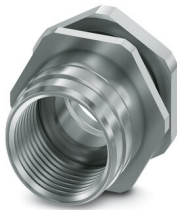

Housing screw connection, Socket, M12-Push-Pull, Front mounting, M14 x 1, THR- und Wellenlötkontakte

Phoenix Contact 2022 © - all rights reserved

<https://www.phoenixcontact.com>

PHOENIX CONTACT Ltd
Halesfield 13, Telford
Shropshire, TF7 4PG
01952 681700
info@phoenixcontact.co.uk