

Apollo Carrier Board

UserManual

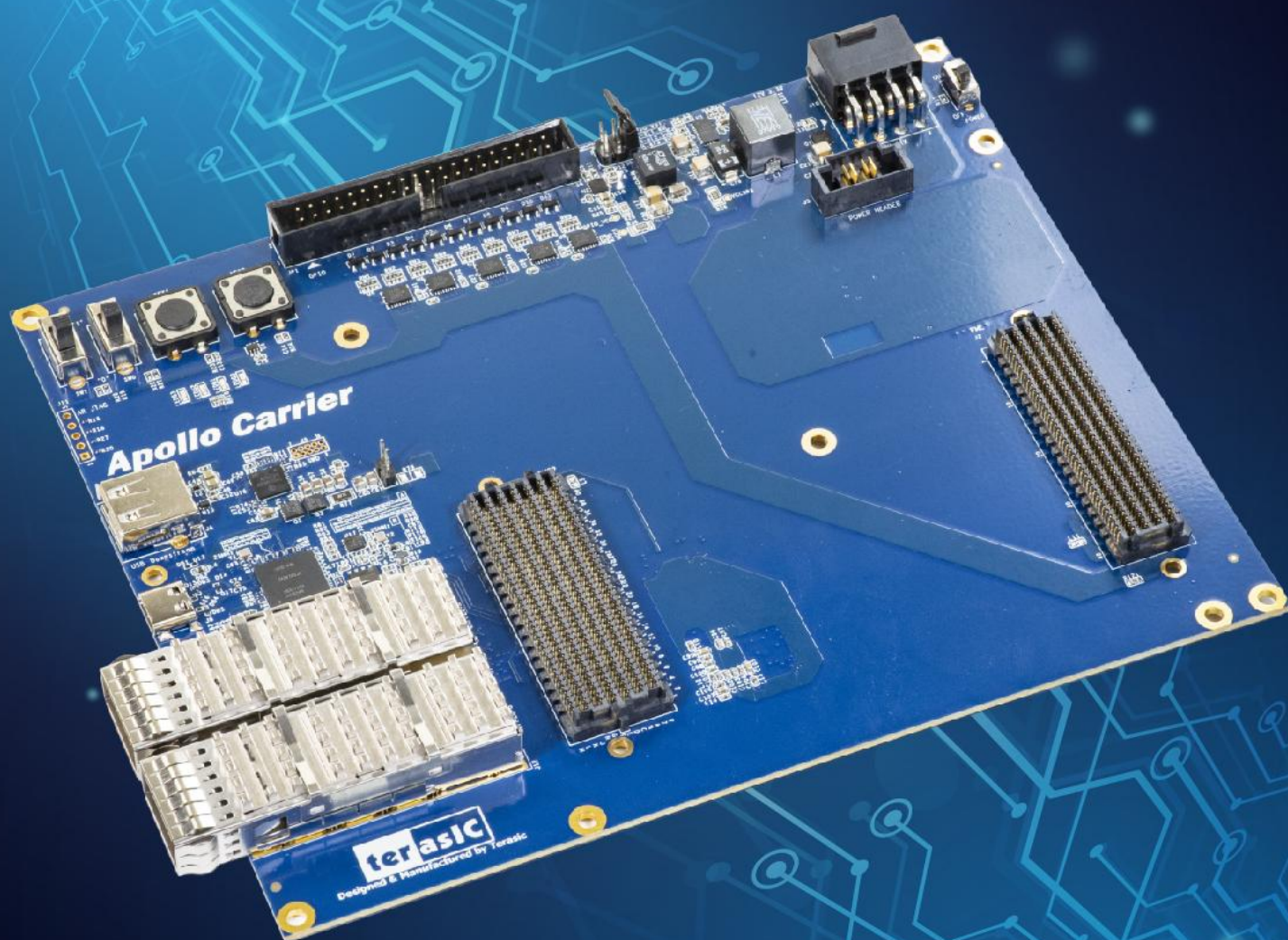

Chapter 1	Overview	3
1.1	General Description	3
1.2	Key Features.....	4
1.3	Block Diagram	4
Chapter 2	Board Components	5
2.1	Board Overview	5
2.2	Power Input and Switch	5
2.3	General User Input and Output	6
2.4	Clock Generator	11
2.5	QSFP28 Ports	12
2.6	PCI Express	14
2.7	USB Downstream Port	15
Chapter 3	Board Assembly	17
3.1	SAMTEC JOM.....	17
3.2	Assembly	18
3.3	Disassembly	20
Chapter 4	Setup Thunderbolt 3	23
4.1	Hardware Requirement	23
4.2	Thunderbolt 3 Test on Windows OS	24
4.3	Detect PCIe Device in the FPGA	26
Chapter 5	PCI Express Reference Design for Windows.....	28
5.1	PCI Express System Infrastructure	28
5.2	PC PCI Express Software SDK.....	29
5.3	PCI Express Software Stack.....	29
5.4	PCI Express Library API.....	34
5.5	PCIe Reference Design - DDR4.....	39
Chapter 6	Transceiver Verification.....	47



6.1 Transceiver Test Code47

6.2 QSFP28 Ports.....47

6.3 40G Ethernet Example48

Chapter 7 Additional Information..... 54

7.1 Getting Help.....54

Chapter 1

Overview

This chapter provides an overview of the Apollo Carrier board and installation guide.

1.1 General Description

Apollo Carrier board is a Carrier board design for Terasic Apollo S10 SoM board. Apollo Carrier board and Apollo S10 SoM board communication via FMC and FMC+ connectors. Apollo Carrier board provides 12V DC power for Apollo S10 via SAMTEC 2x6 connector.

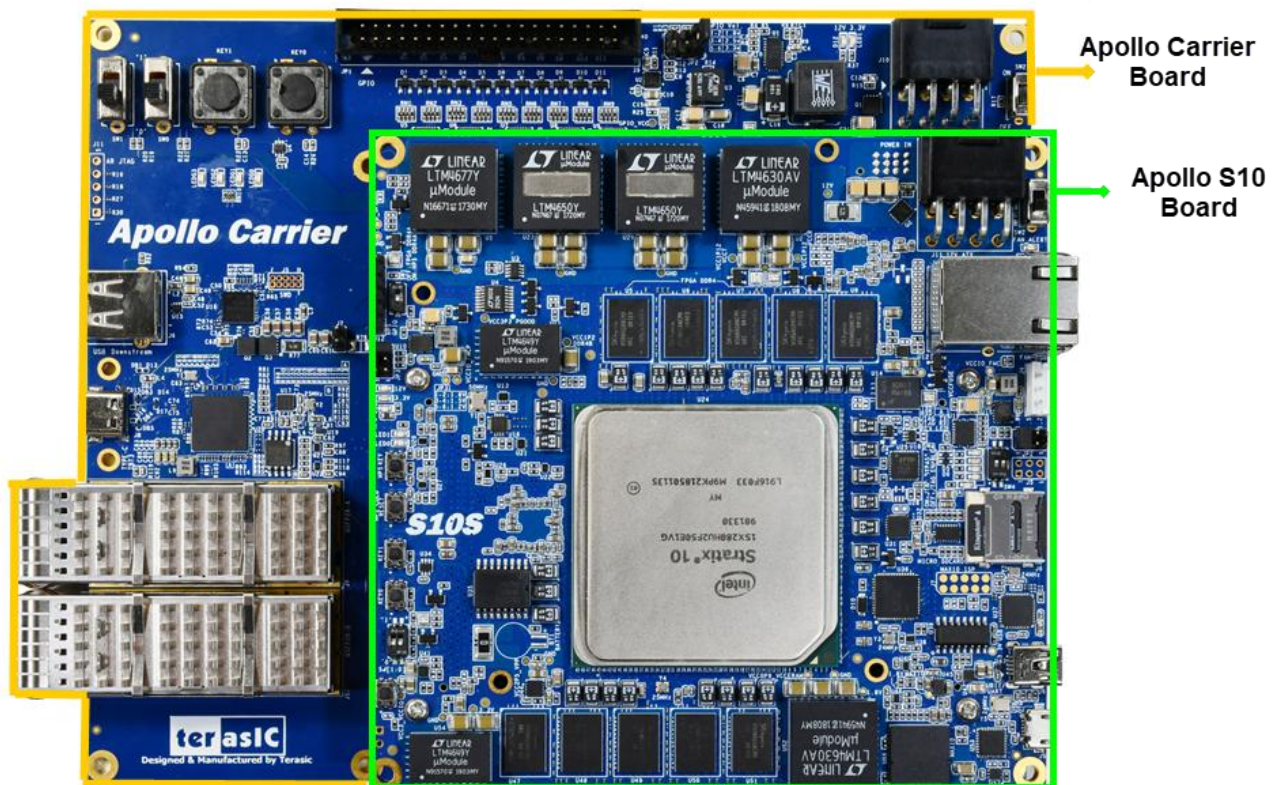

Figure 1-1 Apollo S10 SoM and Carrier board

1.2 Key Features

The following hardware is implemented on the Apollo Carrier board:

- Carrier board for Apollo S10 SoM
- Power input: 12V DC via PCIe 2x4 power connector
- Provides 12V DC to S10 via SAMTEC 2x6 power connector
- Signals connect to S10 via FMC+(J1) and FMC connectors
- PCIe Gen3 x4 via Thunderbolt 3 (Type-C connector)
- USB Downstream port via Thunderbolt 3 (Type-A connector)
- Two QSFP28 connectors (40G Ethernet)
- Clock generator to provide reference clock for transceiver IP
- LED x4, Button x2, Switch x2
- 2x20 3.3V GPIO expansion header
- HDMI-TX Port. Not function now, reserved for future

1.3 Block Diagram

Figure 1-2 shows the block diagram of the Apollo Carrier board.

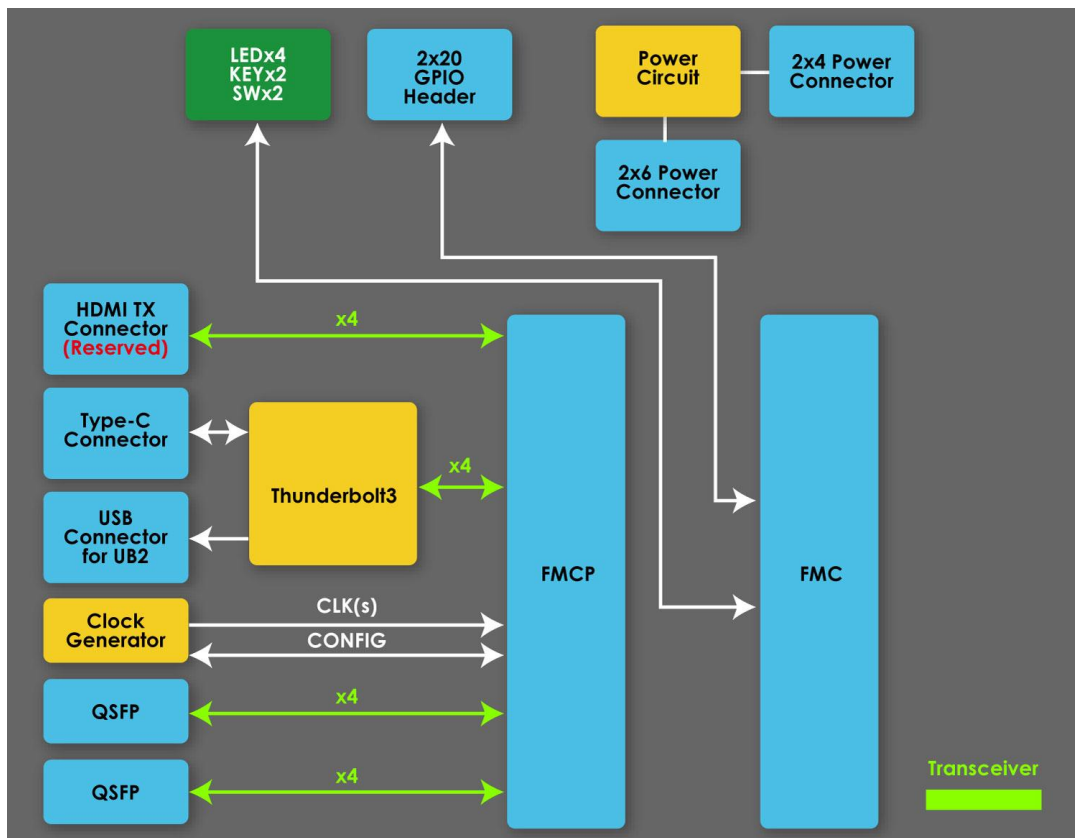

Figure 1-2 Block Diagram of the Apollo Carrier Board

Chapter 2

Board Components

This chapter introduces all the important components on the Apollo Carrier Board.

2.1 Board Overview

Figure 2-1 is the top view of the Apollo Carrier Board. It depicts the layout of the board and indicates the location of the connectors and key components. Users can refer to this figure for relative location of the connectors and key components.

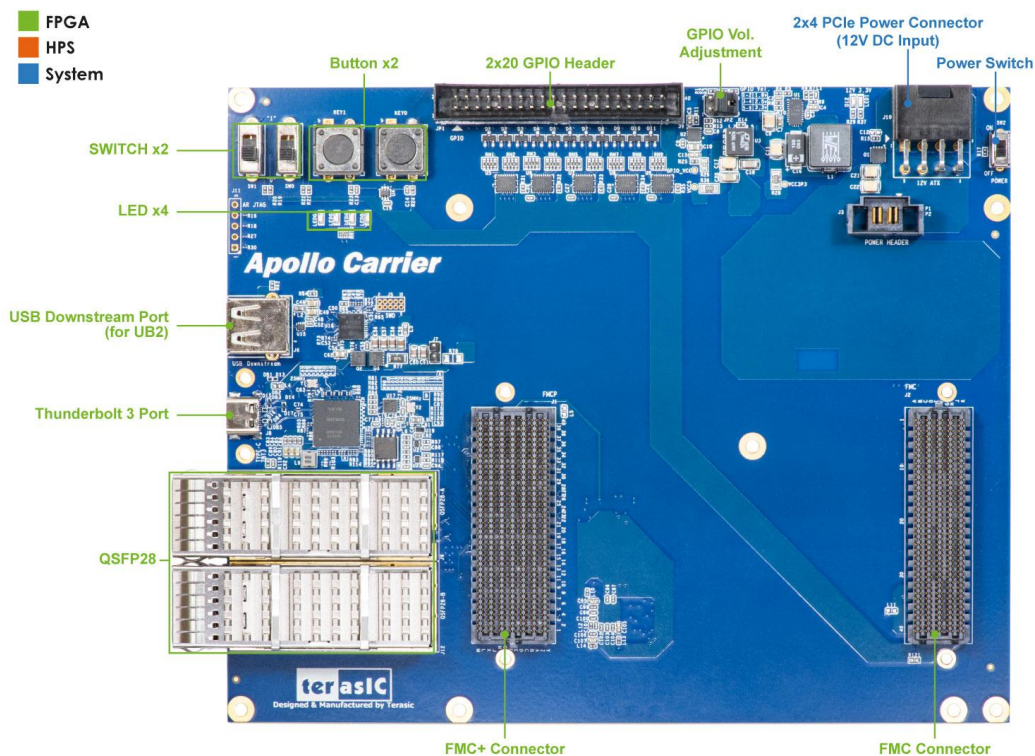

Figure 2-1 Apollo Carrier Board (top view)

2.2 Power Input and Switch

Figure 2-2 shows the 12V DC power input and power switch on the Carrier board. The 12V DC power is input via 2x4 PCIe power connector.

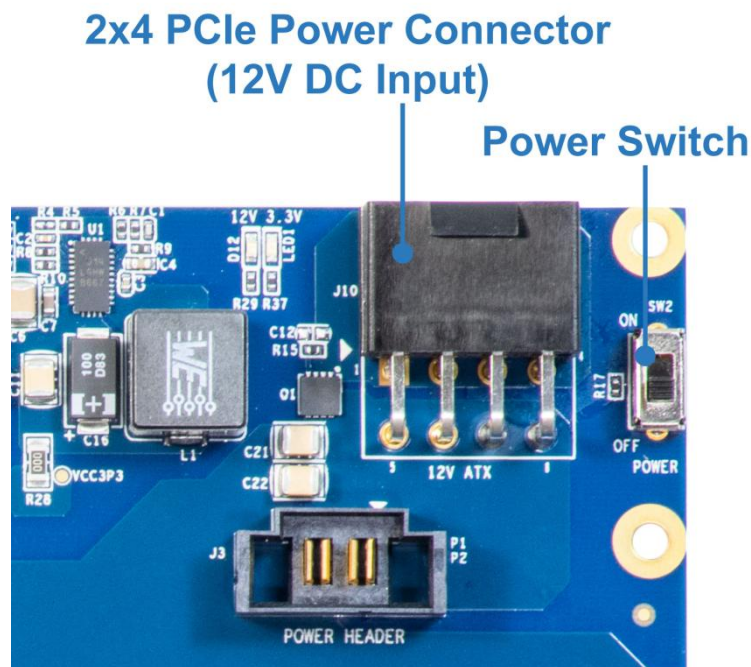

Figure 2-2 Position of 12V DC Input and Power Switch

After Apollo S10 and Apollo Carrier Board are assembled, please:

- Always make Apollo S10 SoM power switch on.
- Do not use the 2x4 PCIe power connector on Apollo S10.

2.3 General User Input and Output

This section describes the user I/O interface of the Carrier board.

■ User Defined Button/Switch/LED

There are two buttons, two switches, and four LEDs on the Carrier board, as shown in **Figure 2-3**.

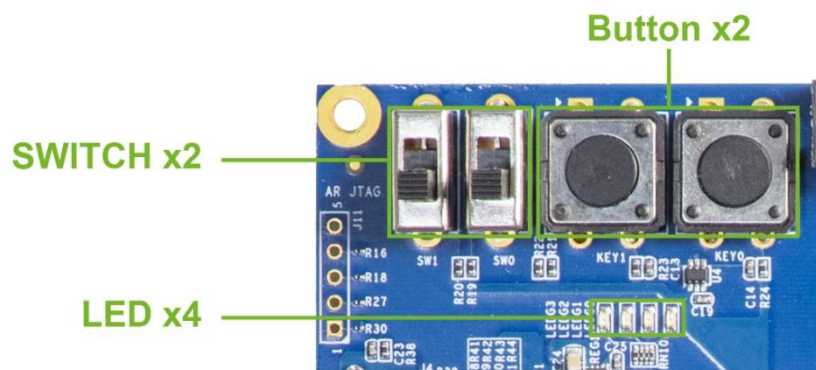

Figure 2-3 User Button, Switch and LED

Table 2-1 General User I/O Pin Assignments, Schematic Signal Names, and Functions

Schematic Signal Name	Description	I/O Standard	FMC Pin Num.	Apollo S10 FPGA Pin Num.
LED[0]	Driving logic 0 on the I/O port turns the LED ON. Driving logic 1 on the I/O port turns the LED OFF.	1.8 V	D17	PIN_E21
LED[1]		1.8 V	D18	PIN_D21
LED[2]		1.8 V	H19	PIN_G19
LED[3]		1.8 V	H20	PIN_F19
SW[0]	High logic level when SW in the UPPER position.	1.8 V	D14	PIN_G20
SW[1]		1.8 V	D15	PIN_H20
KEY[0]	High Logic Level when the button is not pressed	1.8 V	C14	PIN_J21
KEY[1]		1.8 V	C15	PIN_H21

■ 2x20 GPIO Header (Timing Expansion Header)

The board has one 2x20 GPIO headers. The header has 36 user pins connected to the FMC connector via voltage level translator (See **Figure 2-4**). The 2x20 GPIO I/O standard can support three I/O standards including 1.8, 2.5 and 3.3V. Users can select the desired voltage setting through the JP2 header (See **Figure 2-5** and **Table 2-2**). It also comes with DC +5V (VCC5), DC +3.3V (VCC3P3), and two GND pins. **Figure 2-6** and **Figure 2-7** show the I/O distribution of the GPIO connector. The maximum power consumption allowed for a daughter card connected to the GPIO ports is shown in **Table 2-3** and **Table 2-4** shows all the pin assignments of the GPIO connector. The pin-out of JP1 is shown in

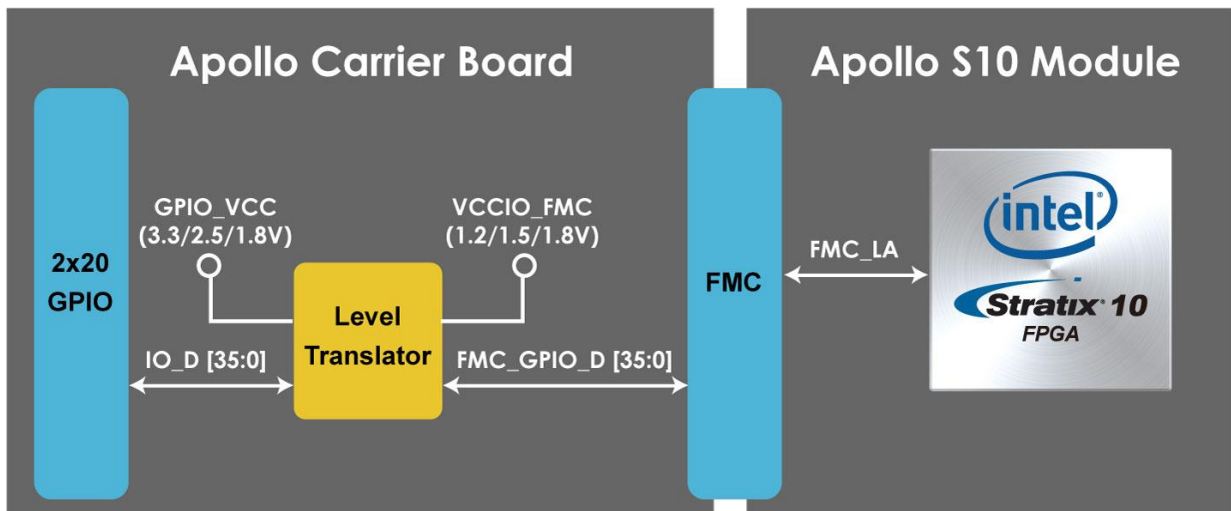

Figure 2-4 Connection between 2x20 GPIO and Apollo S10 SoM

GPIO Voltage Adjustment Header

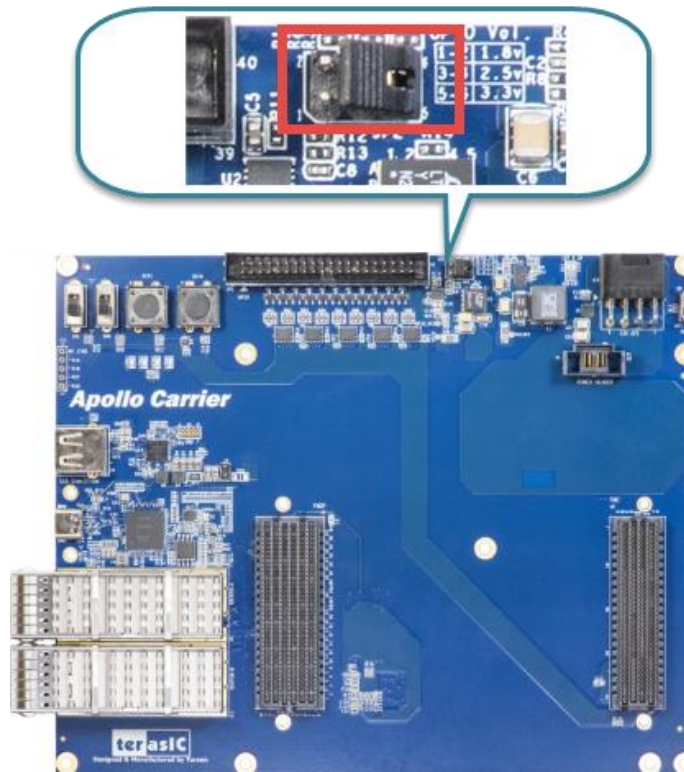

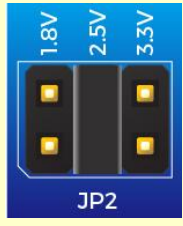

Figure 2-5 Location of the JP2

Table 2-2 Header setting for I/O standard of the JP2

JP2 Setting	FMC I/O Standard
 <p>JP2</p>	3.3V(Default Setting)
 <p>JP2</p>	2.5V

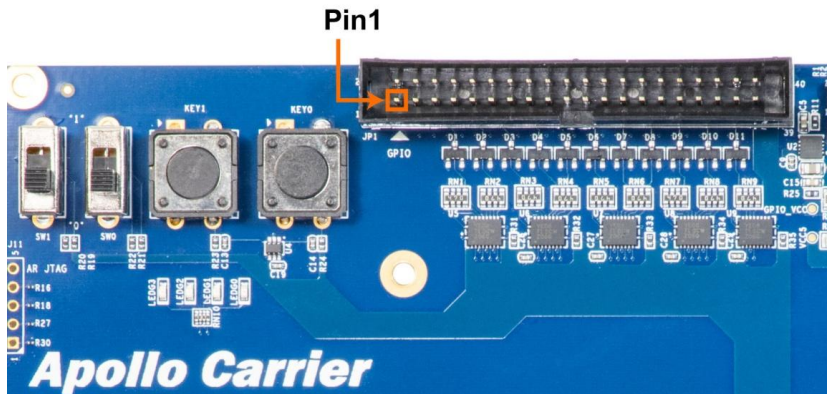
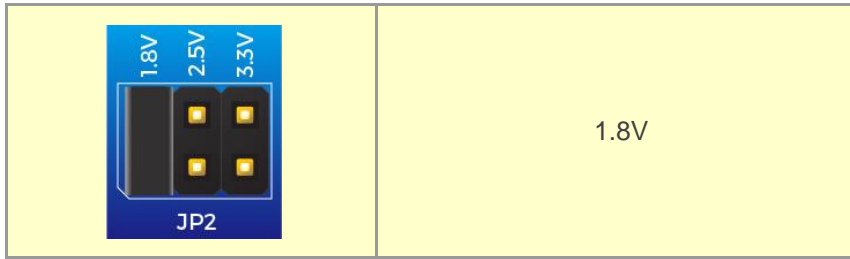

Figure 2-6 Pin 1 of the GPIO header

GPIO 0 (JP1)					
Pin_J20	GPIO_0[0]	1	□	2	GPIO_0[1] Pin_C23
Pin_E18	GPIO_0[2]	3	○	4	GPIO_0[3] Pin_G24
Pin_B23	GPIO_0[4]	5	○	6	GPIO_0[5] Pin_H22
Pin_F24	GPIO_0[6]	7	○	8	GPIO_0[7] Pin_J24
Pin_K23	GPIO_0[8]	9	○	10	GPIO_0[9] Pin_R23
	5V	11	○	12	GND
Pin_G22	GPIO_0[10]	13	○	14	GPIO_0[11] Pin_J23
Pin_F22	GPIO_0[12]	15	○	16	GPIO_0[13] Pin_E22
Pin_K24	GPIO_0[14]	17	○	18	GPIO_0[15] Pin_A24
Pin_C20	GPIO_0[16]	19	○	20	GPIO_0[17] Pin_B24
Pin_A19	GPIO_0[18]	21	○	22	GPIO_0[19] Pin_D20
Pin_F17	GPIO_0[20]	23	○	24	GPIO_0[21] Pin_C18
Pin_E17	GPIO_0[22]	25	○	26	GPIO_0[23] Pin_F21
Pin_B18	GPIO_0[24]	27	○	28	GPIO_0[25] Pin_F20
	3.3V	29	○	30	GND
Pin_B19	GPIO_0[26]	31	○	32	GPIO_0[27] Pin_C17
Pin_A22	GPIO_0[28]	33	○	34	GPIO_0[29] Pin_P23
Pin_A17	GPIO_0[30]	35	○	36	GPIO_0[31] Pin_A21
Pin_B22	GPIO_0[32]	37	○	38	GPIO_0[33] Pin_A20
Pin_B20	GPIO_0[34]	39	○	40	GPIO_0[35] Pin_B17

Figure 2-7 Pin-out of 2x20 GPIO Header JP1

Table 2-3 Voltage and Max. Current Limit of GPIO Header

JP2 Setting	FMC I/O Standard
5V	1A (depend on the power adapter specification.)
3.3V	1.5A

Table 2-4 2x20 GPIO Pin Assignments, Schematic Signal Names, and Functions

Schematic Signal Name	Description	I/O Standard	FMC Pin Num.	Apollo S10 FPGA Pin Num.
FMC_GPIO_D[0]	GPIO Connection[0]	3.3(Default)/2.5/1.8V	G6	PIN_J20
FMC_GPIO_D[1]	GPIO Connection[1]	3.3(Default)/2.5/1.8V	G33	PIN_C23
FMC_GPIO_D[2]	GPIO Connection[2]	3.3(Default)/2.5/1.8V	D8	PIN_E18
FMC_GPIO_D[3]	GPIO Connection[3]	3.3(Default)/2.5/1.8V	H32	PIN_G24
FMC_GPIO_D[4]	GPIO Connection[4]	3.3(Default)/2.5/1.8V	G34	PIN_B23
FMC_GPIO_D[5]	GPIO Connection[5]	3.3(Default)/2.5/1.8V	G31	PIN_H22
FMC_GPIO_D[6]	GPIO Connection[6]	3.3(Default)/2.5/1.8V	H31	PIN_F24
FMC_GPIO_D[7]	GPIO Connection[7]	3.3(Default)/2.5/1.8V	H29	PIN_J24
FMC_GPIO_D[8]	GPIO Connection[8]	3.3(Default)/2.5/1.8V	C27	PIN_K23
FMC_GPIO_D[9]	GPIO Connection[9]	3.3(Default)/2.5/1.8V	G28	PIN_R23
FMC_GPIO_D[10]	GPIO Connection[10]	3.3(Default)/2.5/1.8V	G30	PIN_G22
FMC_GPIO_D[11]	GPIO Connection[11]	3.3(Default)/2.5/1.8V	C26	PIN_J23
FMC_GPIO_D[12]	GPIO Connection[12]	3.3(Default)/2.5/1.8V	D27	PIN_F22
FMC_GPIO_D[13]	GPIO Connection[13]	3.3(Default)/2.5/1.8V	D26	PIN_E22
FMC_GPIO_D[14]	GPIO Connection[14]	3.3(Default)/2.5/1.8V	H28	PIN_K24
FMC_GPIO_D[15]	GPIO Connection[15]	3.3(Default)/2.5/1.8V	D24	PIN_A24
FMC_GPIO_D[16]	GPIO Connection[16]	3.3(Default)/2.5/1.8V	C23	PIN_C20
FMC_GPIO_D[17]	GPIO Connection[17]	3.3(Default)/2.5/1.8V	D23	PIN_B24
FMC_GPIO_D[18]	GPIO Connection[18]	3.3(Default)/2.5/1.8V	G15	PIN_A19
FMC_GPIO_D[19]	GPIO Connection[19]	3.3(Default)/2.5/1.8V	C22	PIN_D20
FMC_GPIO_D[20]	GPIO Connection[20]	3.3(Default)/2.5/1.8V	G18	PIN_F17
FMC_GPIO_D[21]	GPIO Connection[21]	3.3(Default)/2.5/1.8V	D21	PIN_C18
FMC_GPIO_D[22]	GPIO Connection[22]	3.3(Default)/2.5/1.8V	G19	PIN_E17
FMC_GPIO_D[23]	GPIO Connection[23]	3.3(Default)/2.5/1.8V	C19	PIN_F21
FMC_GPIO_D[24]	GPIO Connection[24]	3.3(Default)/2.5/1.8V	G21	PIN_B18
FMC_GPIO_D[25]	GPIO Connection[25]	3.3(Default)/2.5/1.8V	C18	PIN_F20
FMC_GPIO_D[26]	GPIO Connection[26]	3.3(Default)/2.5/1.8V	G22	PIN_B19
FMC_GPIO_D[27]	GPIO Connection[27]	3.3(Default)/2.5/1.8V	D20	PIN_C17
FMC_GPIO_D[28]	GPIO Connection[28]	3.3(Default)/2.5/1.8V	H22	PIN_A22
FMC_GPIO_D[29]	GPIO Connection[29]	3.3(Default)/2.5/1.8V	G27	PIN_P23

FMC_GPIO_D[30]	GPIO Connection[30]	3.3(Default)/2.5/1.8V	G24	PIN_A17
FMC_GPIO_D[31]	GPIO Connection[31]	3.3(Default)/2.5/1.8V	H26	PIN_A21
FMC_GPIO_D[32]	GPIO Connection[32]	3.3(Default)/2.5/1.8V	H23	PIN_B22
FMC_GPIO_D[33]	GPIO Connection[33]	3.3(Default)/2.5/1.8V	H25	PIN_A20
FMC_GPIO_D[34]	GPIO Connection[34]	3.3(Default)/2.5/1.8V	G16	PIN_B20
FMC_GPIO_D[35]	GPIO Connection[35]	3.3(Default)/2.5/1.8V	G25	PIN_B17

2.4 Clock Generator

The Carrier board includes one Si5340A clock generator to provide reference clock for FPGA transceiver IP as shown in **Figure 2-8**. To enable the clock generator, developers must well control the control pins Si5340A_OE_n and Si5340A_RST_n on the Si5340A.

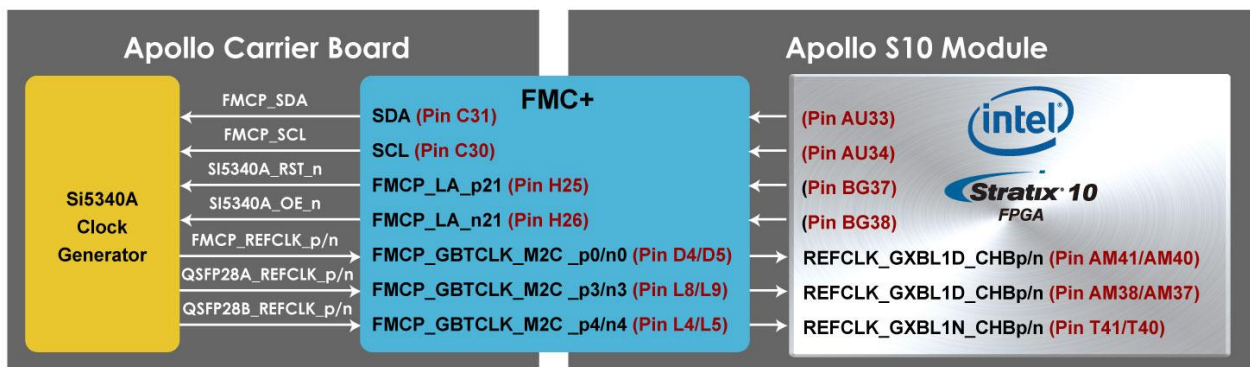

Figure 2-8 Si5340A of the Carrier Board

Table 2-5 Clock Generator Pin Assignments, Schematic Signal Names, and Functions

Schematic Signal Name	Description	I/O Standard	Default Freq.	FMC+ Pin Num.	Apollo S10 FPGA Pin Num.
FMCP_REFCLK_p	Reference clock FMC+ connector	LVDS	644.53125MHz	D4	PIN_AM41
QSFP28A_REFCLK_p	Reference clock for QSFP28A	LVDS	644.53125MHz	L8	PIN_AM38
QSFP28B_REFCLK_p	Reference clock for QSFP28B	LVDS	644.53125MHz	L4	PIN_T41
Si5340A_I2C_SCL	I2C clock bus of the clock generator	1.8V	--	H32	PIN_AU34
Si5340A_I2C_SDA	I2C data bus of the clock generator	1.8V	--	G34	PIN_AU33
Si5340A_OE_n	Enable output of the clock generator	1.8V	--	G31	PIN_BG38
Si5340A_RST_n	Reset of the clock	1.8V	--	H31	PIN_BG37

2.5 QSFP28 Ports

The Carrier board has two independent 40G QSFP28 connectors that use one transceiver channel each from the Stratix 10 FPGA device. These modules take in serial data from the Stratix 10 FPGA device and transform them to optical signals. The board includes cage assemblies for the QSFP28 connectors. **Figure 2-9** shows the connections between the QSFP28 and Stratix 10 FPGA.

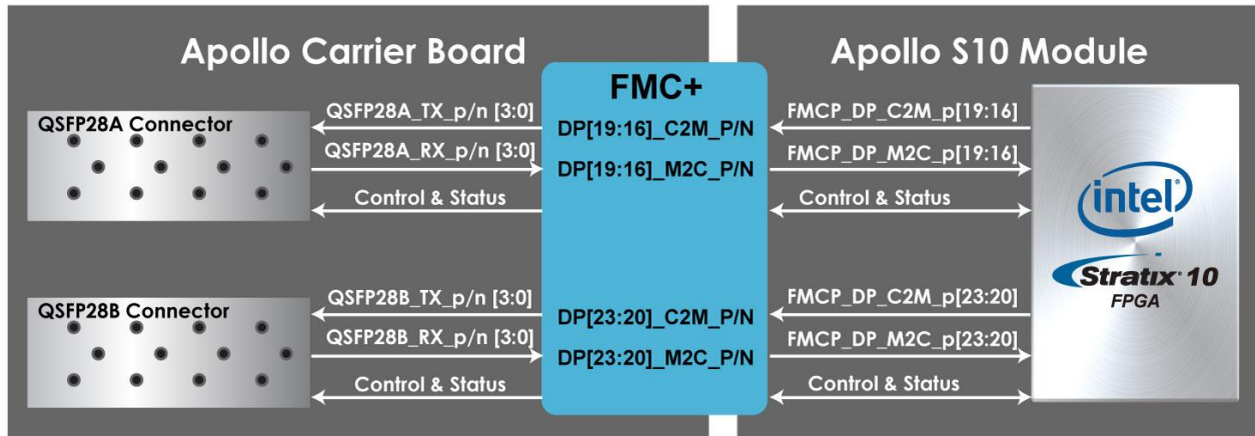

Figure 2-9 Connection between the QSFP28 and Stratix 10 FPGA

Table 2-6 QSP28A/B Pin Assignments, Schematic Signal Names, and Functions

Schematic Signal Name	Description	I/O Standard	FMC Pin Num.	Apollo S10 FPGA Pin Num.
QSFP28A_INTERRUPT_n	Interrupt	1.8 V	H32	PIN_BF3
QSFP28A_LP_MODE	Low Power Mode	1.8 V	H31	PIN_BG3
QSFP28A_MOD_PRS_n	Module Present	1.8 V	G30	PIN_BC3
QSFP28A_MOD_SEL_n	Module Select	1.8 V	H28	PIN_BF3
QSFP28A_RST_n	Module Reset	1.8 V	H29	PIN_BF3
QSFP28A_SCL	2-wire serial interface clock	1.8 V	D26	PIN_BD3
QSFP28A_SDA	2-wire serial interface data	1.8 V	D27	PIN_BD3
QSFP28A_REFCLK_p	QSFP28A transceiver reference clock p	LVDS	L8	PIN_AM3
QSFP28A_RX_p[0]	Receiver data of channel 0	HSSI DIFFERENTIAL I/O	Z32	PIN_AL4
QSFP28A_RX_p[1]	Receiver data of channel 1	HSSI DIFFERENTIAL I/O	Y34	PIN_AH4
QSFP28A_RX_p[2]	Receiver data of channel 2	HSSI DIFFERENTIAL I/O	Z36	PIN_AF4
QSFP28A_RX_p[3]	Receiver data of channel 3	HSSI DIFFERENTIAL I/O	Y38	PIN_AG4

QSFP28A_TX_p[0]	Transmitter data of channel 0	HSSI DIFFERENTIAL I/O	M26	PIN_AK4
QSFP28A_TX_p[1]	Transmitter data of channel 1	HSSI DIFFERENTIAL I/O	M30	PIN_AL4
QSFP28A_TX_p[2]	Transmitter data of channel 2	HSSI DIFFERENTIAL I/O	M34	PIN_AJ4
QSFP28A_TX_p[3]	Transmitter data of channel 3	HSSI DIFFERENTIAL I/O	M38	PIN_AF4
QSFP28B_INTERRUPT_n	Interrupt	1.8 V	H37	PIN_BJ3
QSFP28B_LP_MODE	Low Power Mode	1.8 V	G34	PIN_BG3
QSFP28B_MOD_PRS_n	Module Present	1.8 V	H38	PIN_BJ3
QSFP28B_MOD_SEL_n	Module Select	1.8 V	G31	PIN_BC3
QSFP28B_RST_n	Module Reset	1.8 V	H34	PIN_BJ3
QSFP28B_SCL	2-wire serial interface clock	1.8 V	H35	PIN_BJ3
QSFP28B_SDA	2-wire serial interface data	1.8 V	G33	PIN_BH3
QSFP28B_REFCLK_p	QSFP28B transceiver reference clock p	LVDS	L4	PIN_T41
QSFP28B_RX_p[0]	Receiver data of channel 0	HSSI DIFFERENTIAL I/O	M14	PIN_G43
QSFP28B_RX_p[1]	Receiver data of channel 1	HSSI DIFFERENTIAL I/O	M10	PIN_D45
QSFP28B_RX_p[2]	Receiver data of channel 2	HSSI DIFFERENTIAL I/O	M6	PIN_C43
QSFP28B_RX_p[3]	Receiver data of channel 3	HSSI DIFFERENTIAL I/O	M2	PIN_A43
QSFP28B_TX_p[0]	Transmitter data of channel 0	HSSI DIFFERENTIAL I/O	Z8	PIN_F49
QSFP28B_TX_p[1]	Transmitter data of channel 1	HSSI DIFFERENTIAL I/O	Y6	PIN_G47
QSFP28B_TX_p[2]	Transmitter data of channel 2	HSSI DIFFERENTIAL I/O	Z4	PIN_E47
QSFP28B_TX_p[3]	Transmitter data of channel 3	HSSI DIFFERENTIAL I/O	Y2	PIN_C47

2.6 PCI Express

The Carrier board is designed to fit entirely into a PC motherboard with PCI Express Gen3 x4 via Thunderbolt 3 Port. Utilizing built-in transceivers on a Stratix 10 device, it is able to provide a fully integrated PCI Express-compliant solution for multi-lane (x1, x4) applications. With the PCI Express hard IP block incorporated in the Stratix 10 device, it will allow users to implement simple and fast protocol, as well as saving logic resources for logic application. **Figure 2-10** presents the pin connection established between the Stratix 10 and PCI Express.

The PCI Express interface supports complete PCI Express Gen1 at 2.5Gbps/lane, Gen2 at 5.0Gbps/lane, and Gen3 at 8.0Gbps/lane protocol stack solution compliant to PCI Express base specification 3.0 that includes PHY-MAC, data Link, and transaction layer circuitry embedded in PCI Express hard IP blocks.

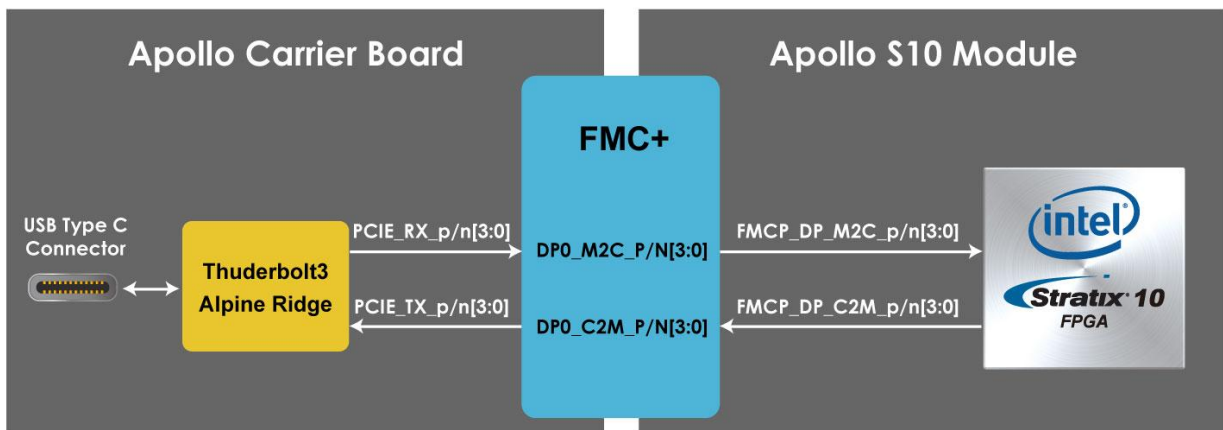

Figure 2-10 PCI Express Pin Connection

Table 2-7 QSP28A/B Pin Assignments, Schematic Signal Names, and Functions

Schematic Signal Name	Description	I/O Standard	FMC Pin Num.	Apollo S10 FPGA Pin Num.
PCIE_REFCLK_p	Reference clock input	LVDS	B20	PIN_AT41
PCIE_RX_p[0]	Receive bus	HSSI DIFFERENTIAL I/O	C6	PIN_BH41
PCIE_RX_p[1]	Receive bus	HSSI DIFFERENTIAL I/O	A2	PIN_BJ43
PCIE_RX_p[2]	Receive bus	HSSI DIFFERENTIAL I/O	A6	PIN_BG43
PCIE_RX_p[3]	Receive bus	HSSI DIFFERENTIAL I/O	A10	PIN_BE43
PCIE_TX_p[0]	Transmit bus	HSSI DIFFERENTIAL I/O	C2	PIN_BJ46
PCIE_TX_p[1]	Transmit bus	HSSI DIFFERENTIAL I/O	A22	PIN_BF45
PCIE_TX_p[2]	Transmit bus	HSSI DIFFERENTIAL I/O	A26	PIN_BG47
PCIE_TX_p[3]	Transmit bus	HSSI DIFFERENTIAL I/O	A30	PIN_BE47

2.7 USB Downstream Port

The Thunderbolt 3 controller on the Apollo carrier board not only allows the FPGA and Host PC to establish PCIe interface connections through a Thunderbolt 3 cable, but also provides another expansion port for a USB downstream port (See **Figure 2-11**). The purpose of this USB downstream port is mainly for connecting the USB Blaster II circuit of the Apollo S10 board. When the Apollo S10 module is connected to the carrier, user can use a mini USB cable to connect the USB Blaster II circuit (a mini USB connector) on the Apollo S10 module and the USB downstream connector (a Type A USB connector) of the carrier board (See **Figure 2-12**). In this way, users can use a Thunderbolt 3 cable to allow the Host PC to establish a JTAG connection with the FPGA via the USB downstream port of the carrier board to the USB Blaster II circuit of the module board. It can eliminate the need for a mini USB cable to connect to the Host PC (See **Figure 2-13**).

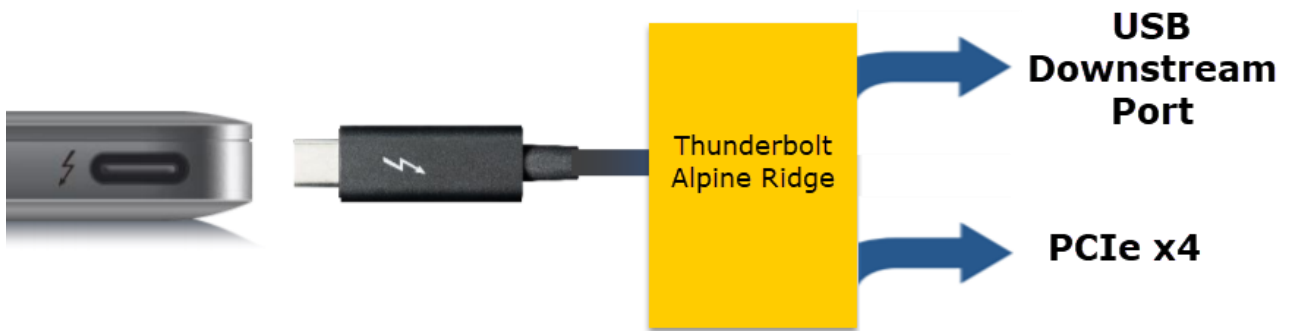

Figure 2-11 Thunderbolt 3 expansion interface on the carrier board

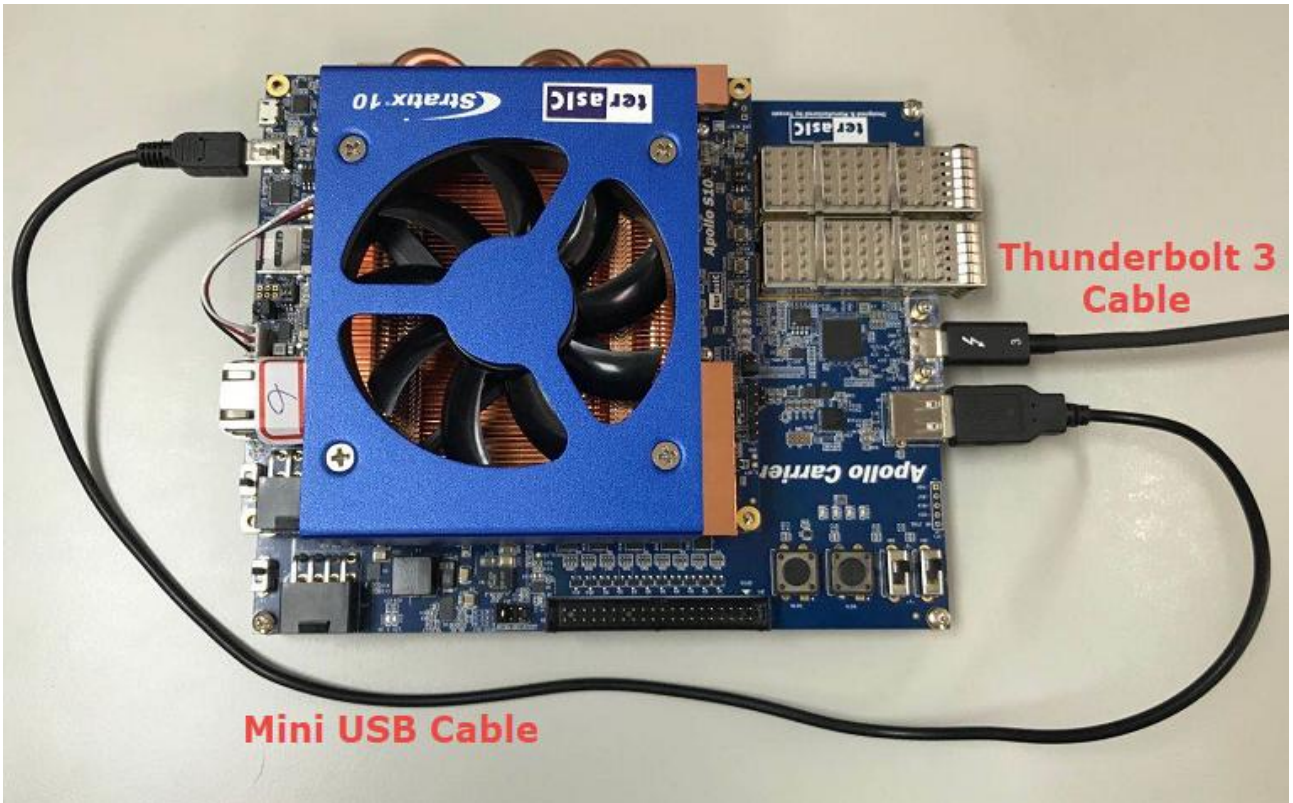

Figure 2-12 Connection setup for USB downstream port (Carrier board) to USB Blaster II Port (Module board)

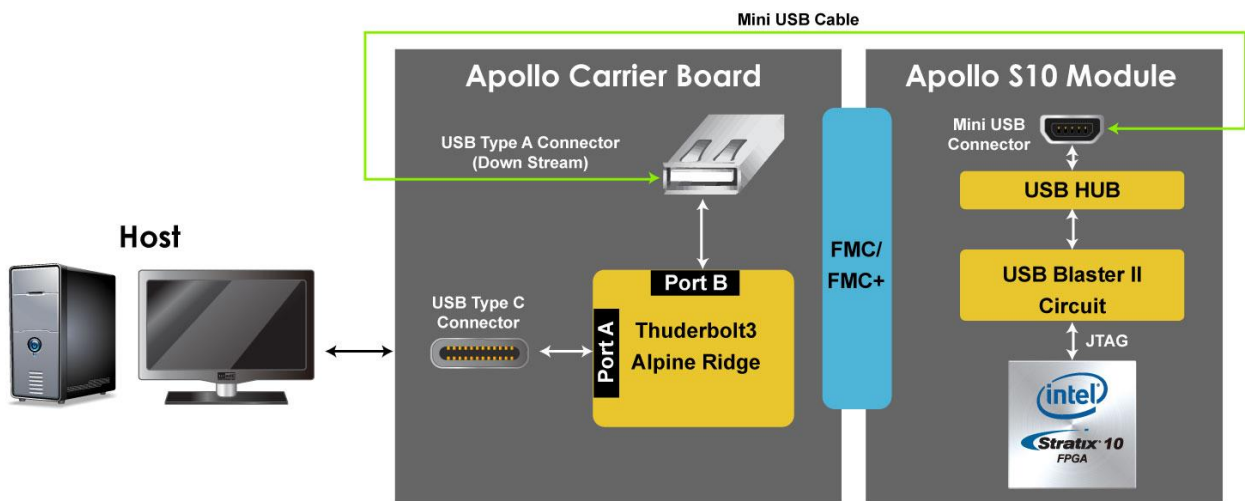

Figure 2-13 JTAG connection via USB downstream port

Chapter 3

Board Assembly

This chapter describes how to assemble Apollo Carrier Board with Apollo S10. SAMTEC JSOM standoff is used for board stacking.

3.1 SAMTEC JSOM

SAMTEC JSOM standoff, as shown in **Figure 3-1**, is used for board stacking. Four JSOM standoff are required to assemble Apollo S10 SoM and Apollo Carrier Board. Each JSOM standoff is consistent with four components. The Apollo S10 kit includes four JSOM standoff as shown in **Table 3-1**. **Table 3-2** lists the tools required to assemble Apollo S10 and Apollo Carrier Board with JSOM standoff.



Figure 3-1 SAMTEC JSOM

Table 3-1 JSOM Components

No.	Description	QTY	Photo
1	M 2.5 x 6mm Screw	4	







2	JSOM-B	4	
3	JSOM-T	4	
4	Hex Nut	4	

Table 3-2 Tools for Assembly

No.	Description	QTY	Photo
1	Philips Screwdriver	1	
2	1.5mm Hex Key	1	
3	5.0mm Hex Socket	1	

3.2 Assembly

Below are the procedures to assemble the Apollo S10 SoM and Apollo Carrier Board or user can refer to the video "[How to assemble Apollo S10 with carrier board](#)" to assemble the board.

1. Use Philips Screwdriver and 5.0mm Hex Socket to screw four M2.5 Screws into four JSOM-B on Apollo S10, as show in **Figure 3-2**.
2. Use a Hex Key to screw four JSOM-T into four JSOM -B as shown in **Figure 3-3**.
3. Place Apollo Carrier Board over the four TSOM-T as shown in **Figure 3-4**.
4. Press Apollo Carrier Board and Apollo S10 to combine the FMC connectors tightly, JSOM-T is bulged on the Apollo Carrier Board as shown in **Figure 3-5**.
5. Use a Hex Key to screw four Hex Nut into the four TSOM-T as shown in **Figure 3-6**.

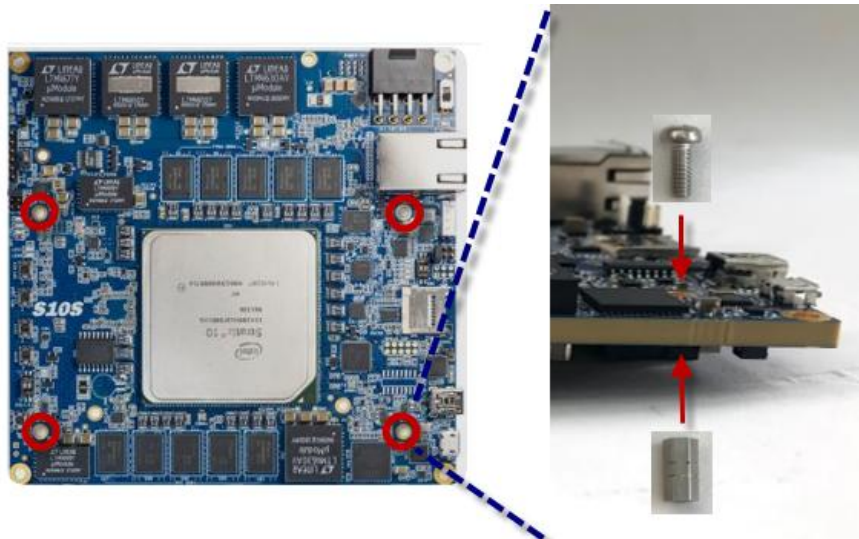

Figure 3-2 Assemble M2.5 Screws and JSOM-B on Apollo S10

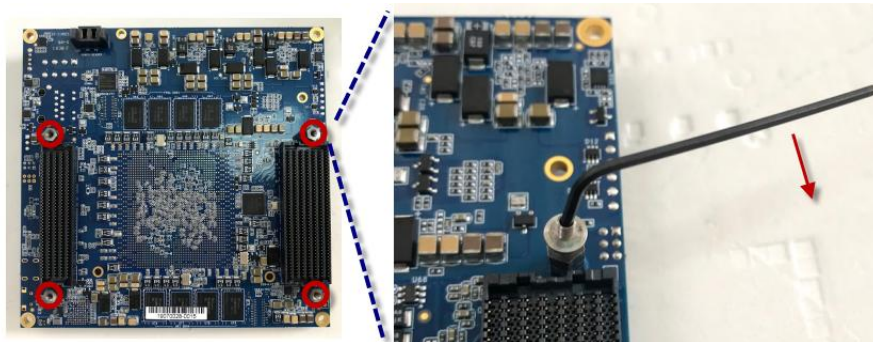

Figure 3-3 Assemble JSOM-T to JSOM-B

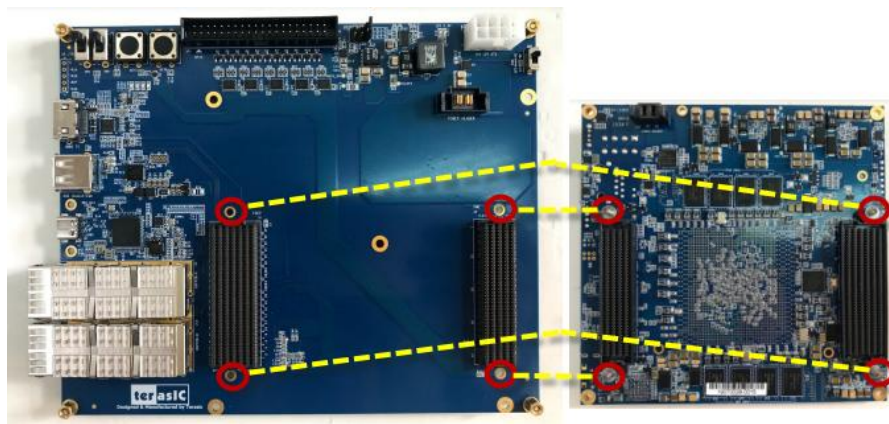

Figure 3-4 Place Apollo Carrier Board over four JSOM-T

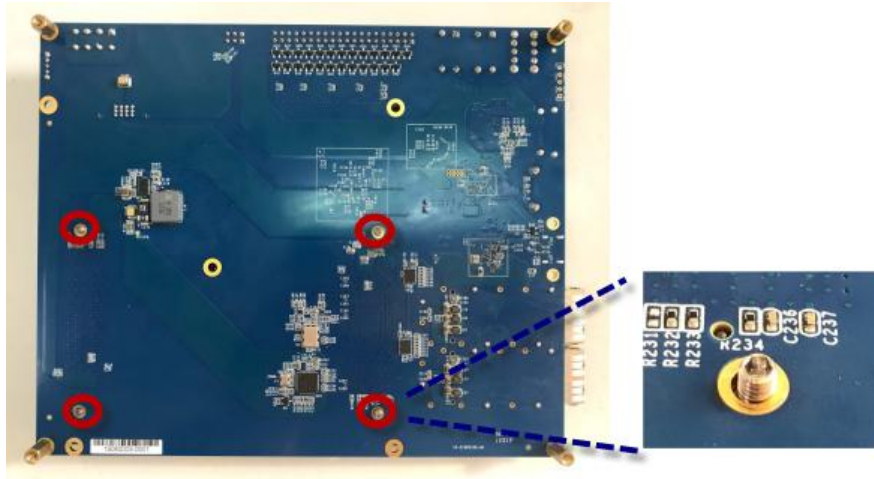

Figure 3-5 Push Apollo Carrier Board onto JSOM-T

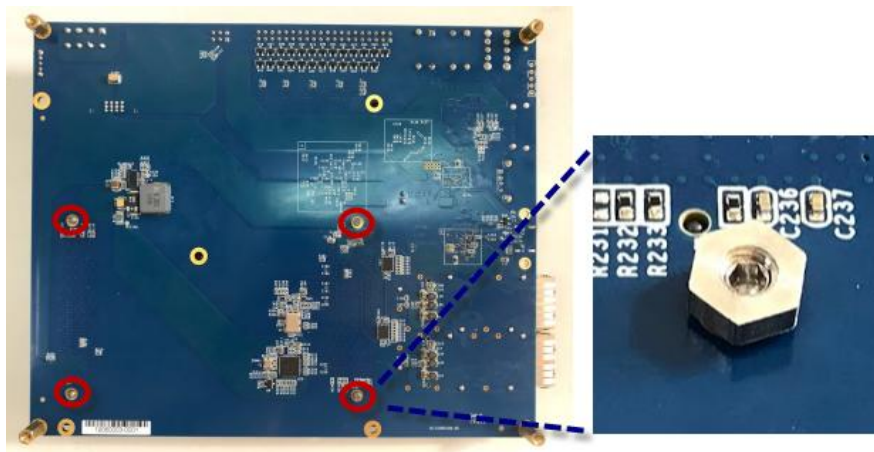

Figure 3-6 Assemble Hex Nut to JSOM-T

3.3 Disassembly

Here are the procedures to disassemble with Apollo S10 SoM and Apollo Carrier Board or users can refer to the video [“How to disassemble Apollo S10 with carrier board”](#) to disassemble the board.

1. Unscrew four Hex Nut as shown in **Figure 3-7**.
2. Unscrew four JSOM-T. Note, as shown in **Figure 3-8**. Take turns to rotate the four JSOM-T one turn at a time until you hear the FMC connector separating sound.
3. Unscrew four JSOM-B as shown in **Figure 3-9**.

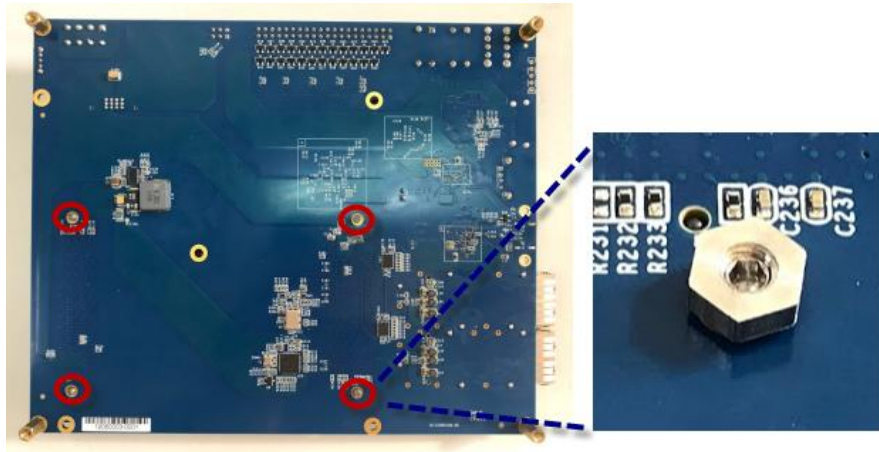

Figure 3-7 Disassemble Hex Nut

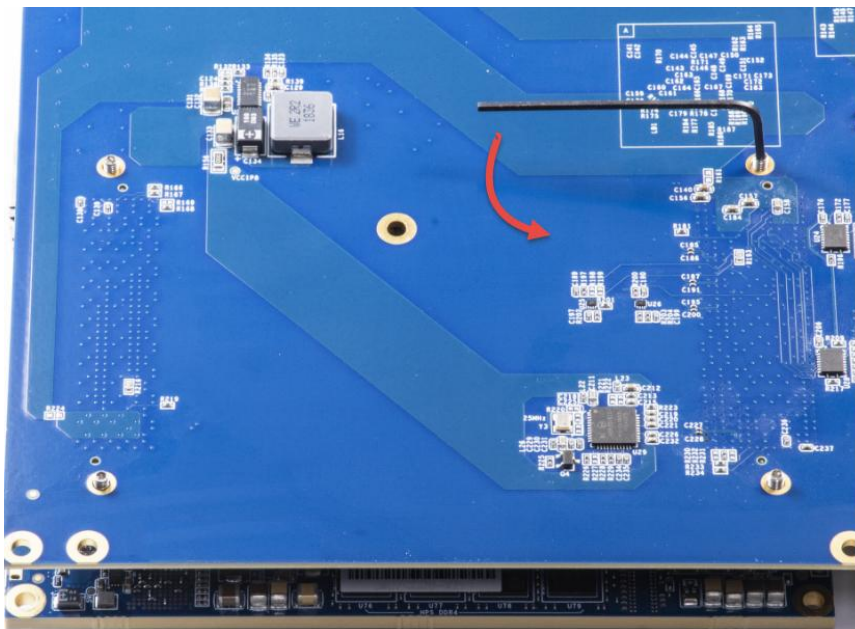

Figure 3-8 Disassemble JSOM-T to JSOM-B

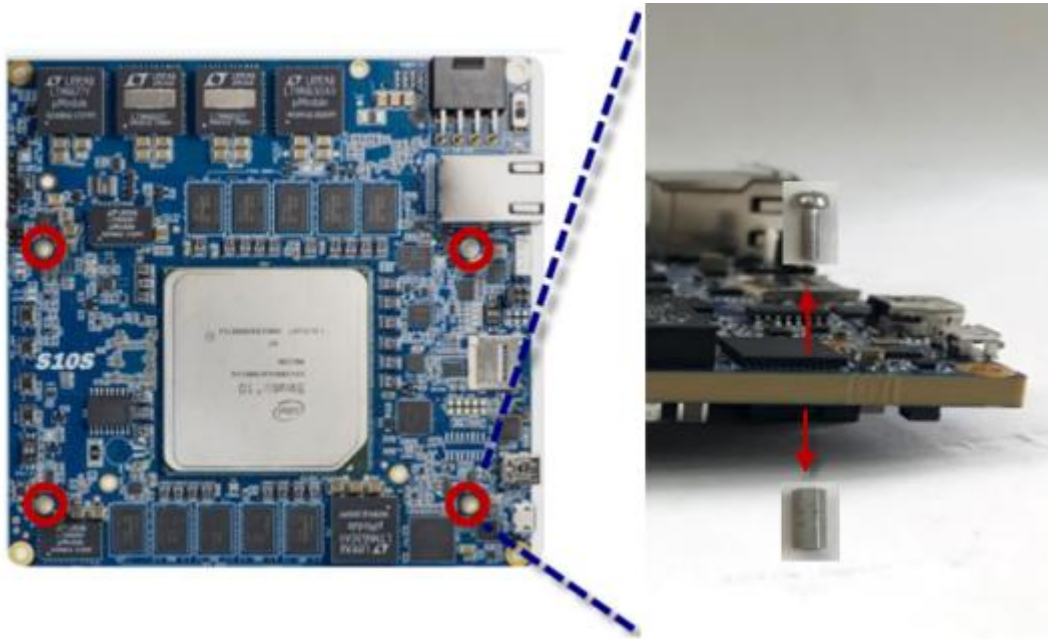

Figure 3-9 Unscrew JSOM-B

Chapter 4

Setup Thunderbolt 3

Thunderbolt 3 is unique communication path between the Host PC and Apollo Carrier board. As shown in **Figure 4-1**, while the Apollo S10 SoM is connected to the carrier board to form the Apollo Developer Kit. With a Thunderbolt 3 cable, Host PC can communicate with the FPGA on the developer kit via PCIe protocol (PCIe design is required in the FPGA). For the OpenCL applications with the Intel FPGA, the PCIe bus is the main interface for communicating and transferring data with the Host PC. The Thunderbolt 3 port on the Apollo Developer Kit allows the user to build PCIe connection for the FPGA and the Host PC via a Thunderbolt 3 cable.

Therefore, a Host PC equipment with Thunderbolt 3 port is required to work with the Apollo Developer Kit for PCIe applications. This chapter will show user how to setup Thunderbolt 3 connection between the Host PC and the Apollo Developer Kit for the first time.

This chapter describes how to set up a Thunderbolt 3 connection in windows and test whether the PCIe device can be detected. **Note, the current Linux PCIe driver provided by Terasic does not support connection via Thunderbolt 3. So the Linux part is not introduced for the time being.**

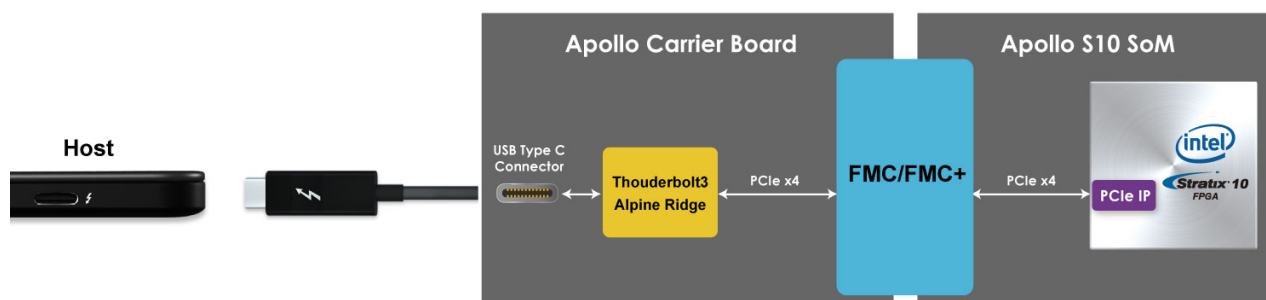

Figure 4-1 PCI Express Pin Connection

4.1 Hardware Requirement

- A Host PC with Thunderbolt 3 Port is required to perform PCIe Applications. The PC should be:
 - Built-in Thunderbolt 3 Port or with Thunderbolt 3 Card Installed.
 - Windows Installed
 - Thunderbolt 3 driver installed

- An Apollo Developer Kit (Apollo S10 SoM + Apollo Carrier board)
- A Thunderbolt 3 Cable as shown in **Figure 4-2**



Figure 4-2 Thunderbolt 3 Cable

4.2 Thunderbolt 3 Test on Windows OS

Below shows the procedure when the Apollo Developer Kit is first time to plug into the Thunderbolt 3 port of the Host PC.

1. Make sure your Host PC had installed Thunderbolt 3 Driver (The [Thunderbolt Control Center](#) is installed).
2. Plug DC Power to power on the Apollo Developer Kit.
3. Connect Apollo Developer Kit and Host PC by a Thunderbolt 3 cable.

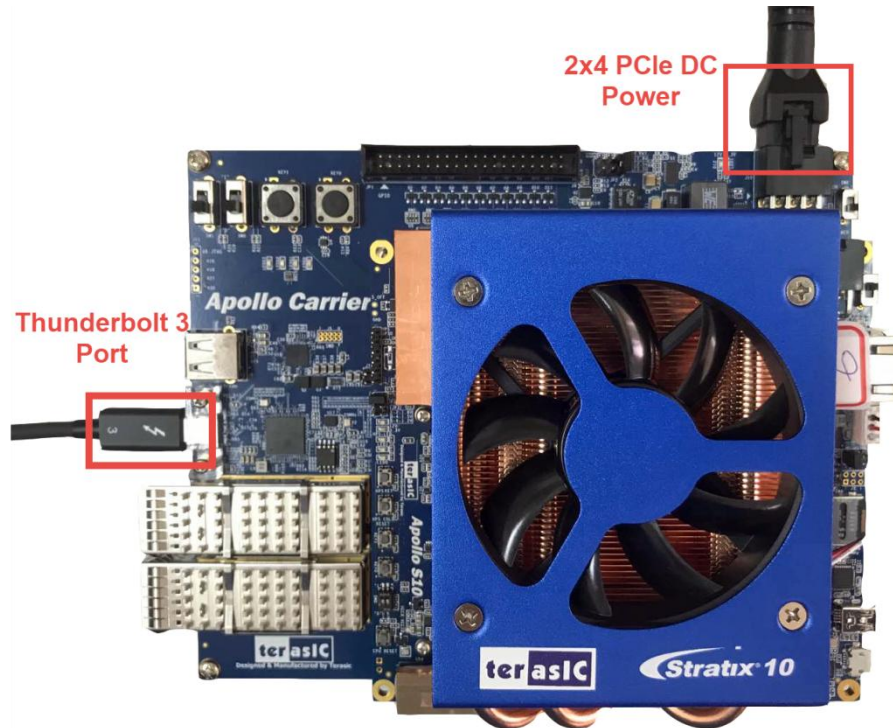

Figure 4-3 Plug the Thunderbolt 3 cable to the Apollo Developer Kit

4. When the Host PC connects to the Apollo Developer Kit with Thunderbolt 3 cable for the first time. Windows should detect a Thunderbolt Device and you will see a “New Thunderbolt device has been connected” message appear in the bottom right corner of your screen as shown in **Figure 4-4**. Click the message to approve the device.

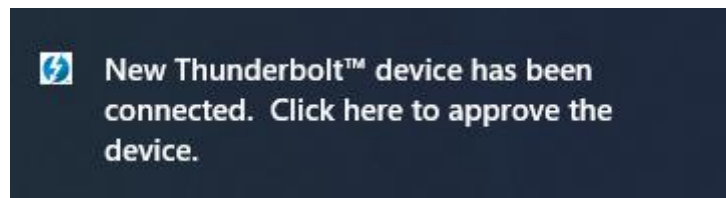

Figure 4-4 New Thunderbolt devices have been attached message

Note that if this message does not appear, user can reconnect the Thunderbolt 3 cable between the Apollo Developer Kit and Host PC or power off and on the Apollo Developer Kit. If the message still doesn't appear, please refer the following link to solve:

http://www.terasic.com.tw/wiki/Apollo_S10_SoM_Setup_Thunderbolt_3_connection_win10

5. A Thunderbolt Dialog window will appear as shown in **Figure 4-5**. Select “Always Connected” and click OK button.

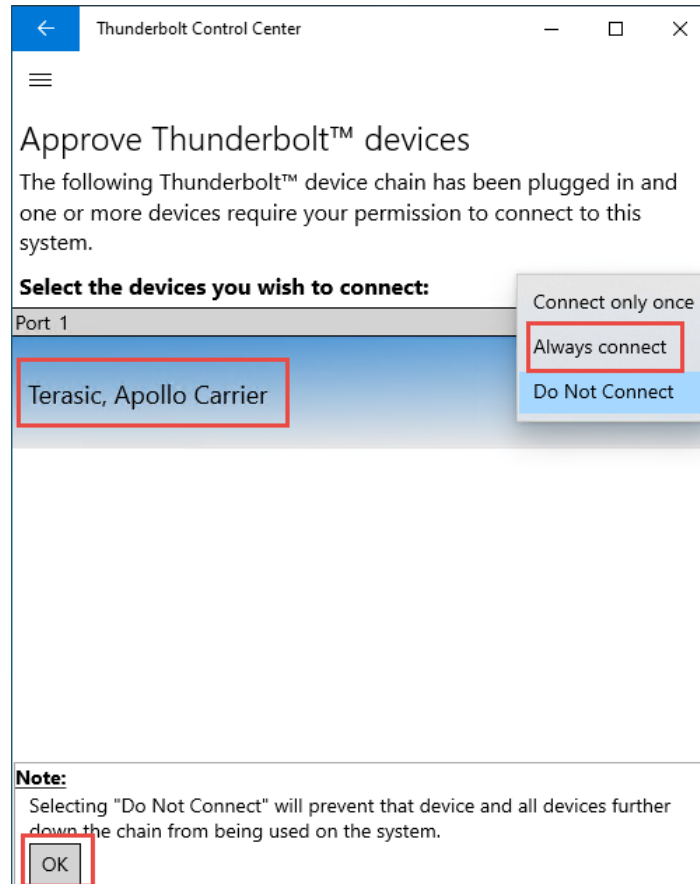

Figure 4-5 Approve Thunderbolt device window

4.3 Detect PCIe Device in the FPGA

Once the Thunderbolt 3 connection is established between Host and Apollo develop kit, if there is no PCIe design in the FPGA, the device manager in win10 on the Host side will not detect the PCIe device. User first needs to program the PCIe design to the FPGA, then re-establish the Thunderbolt 3 connection to the Host that allow the Host to detect the PCIe device in the FPGA.

Below we introduce the use of a Terasic PCIe demo to demonstrate the detection of a PCIe device on the Host.

1. Prepare an Apollo S10 Develop kit (Apollo S10 SoM connected with the Apollo Carrier board).
2. Remove the Micro SD card on the Apollo S10 SoM.
3. Make sure the Mini USB cable is connected between the USB connector (J8) of the Apollo S10 SoM and Host PC.
4. Power on the Apollo S10 Develop kit.
5. Execute the batch file "**test.bat**" from the path "**/Demonstration/PCIe_DDR4/demo_batch/**" in

the system CD to program the FPGA with the PCIe design.

6. Connect the Thunderbolt 3 cable between USB type C connector (J8) in the carrier board and Host PC. Make sure your board and Host has established the Thunderbolt connection setting as described in the **section 4.2**.
7. Open the **Device Manager** in the Win10, you may see an unknown **“PCI Device”** (See **Figure 4-6**), that means the PCIe design is detected by the Host via Thunderbolt 3 interface. If the PCI device does not appear in the Device Manager, please re-plug the Thunderbolt cable again then check again.
8. Next, to install the PCIe driver for FPGA design, please refer to the **section 5.3** for detailed.

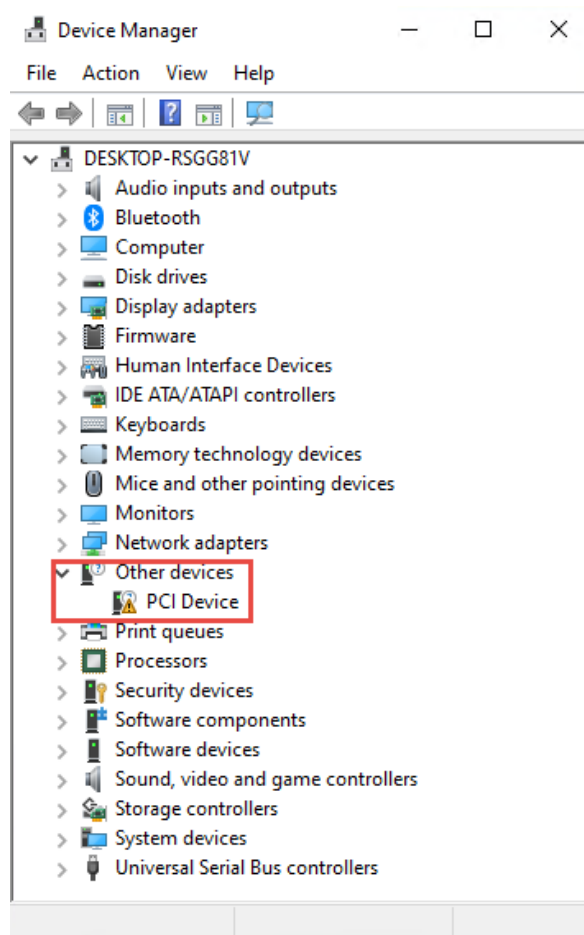

Figure 4-6 PCI Device in the Device Manager

Chapter 5

PCI Express Reference Design for Windows

PCI Express is commonly used in consumer, server, and industrial applications, to link motherboard-mounted peripherals. From this demonstration, it will show how the PC Windows and FPGA communicate with each other through the PCI Express interface. Stratix 10 Hard IP for PCI Express with Avalon-MM DMA IP is used in this demonstration. For detail about this IP, please refer to Intel document [ug_s10_pcie_avmm.pdf](#). Note, before user start to use the PCIe design with the Apollo Develop kit, please refer to the [section 4.3](#) to setup Thunderbolt 3 connection first.

5.1 PCI Express System Infrastructure

Figure 5-1 shows the infrastructure of the PCI Express System in this demonstration. It consists of two primary components: FPGA System and PC System. The FPGA System is developed based on Stratix 10 Hard IP for PCI Express with Avalon-MM DMA. The application software on the PC side is developed by Terasic based on Altera's PCIe kernel mode driver.

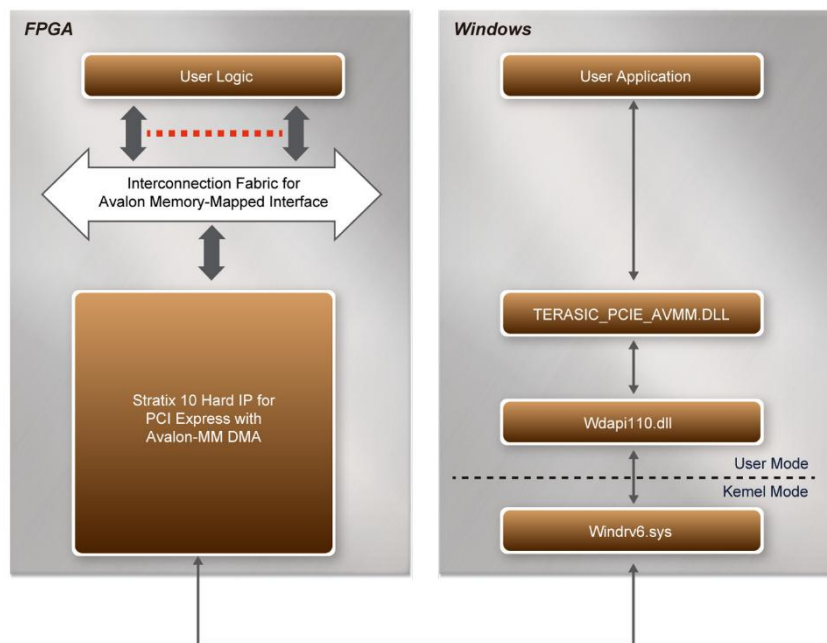

Figure 5-1 Infrastructure of PCI Express System

5.2 PC PCI Express Software SDK

The FPGA System CD contains a PC Windows based SDK to allow users to develop their 64-bit software application on 64-bits Windows 7 or Window 10. The SDK is located in the "CDROM\Demonstrations\PCIe_SW_KIT\Windows" folder which includes:

- PCI Express Driver
- PCI Express Library
- PCI Express Examples

The kernel mode driver assumes the PCIe vendor ID (VID) is 0x1172 and the device ID (DID) is 0xE003. If different VID and DID are used in the design, users need to modify the PCIe vendor ID (VID) and device ID (DID) in the driver INF file accordingly.

The PCI Express Library is implemented as a single DLL named TERASIC_PCIE_AVMM.DLL. This file is a 64-bit DLL. When the DLL is exported to the software API, users can easily communicate with the FPGA. The library provides the following functions:

- Basic data read and write
- Data read and write by DMA

For high performance data transmission, Altera AVMM DMA is required as the read and write operations, which are specified under the hardware design on the FPGA.

5.3 PCI Express Software Stack

Figure 5-2 shows the software stack for the PCI Express application software on 64-bit Windows. The PCIe library module TERASIC_PCIE_AVMM.dll provides DMA and direct I/O access allowing user application program to communicate with FPGA. Users can develop their applications based on this DLL. The altera_pcie_win_driver.sys kernel driver is provided by Intel.

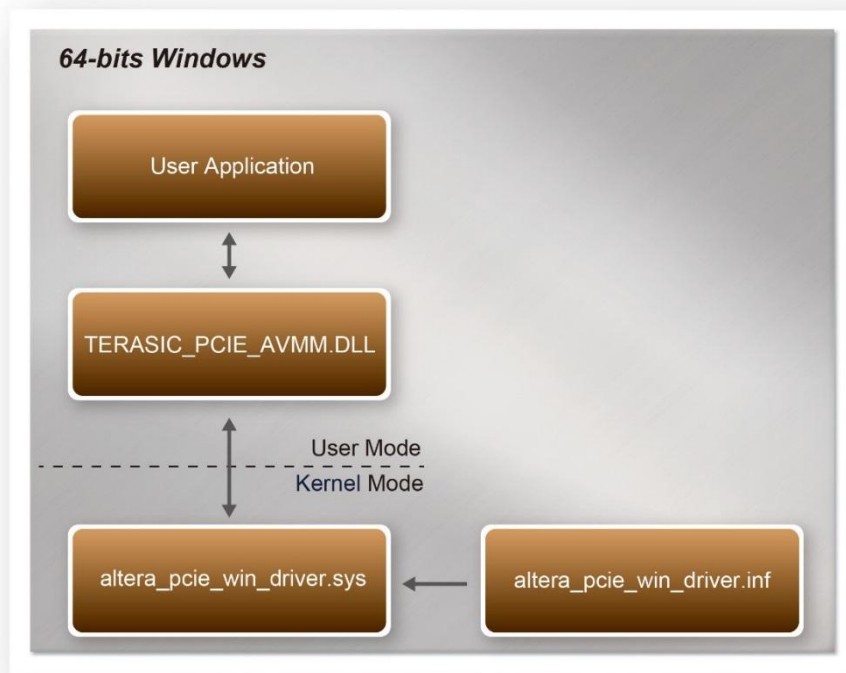

Figure 5-2 PCI Express Software Stack

■ Install PCI Express Driver on Windows

The PCIe driver is located in the folder:

"CDROM\Demonstrations\PCIe_SW_KIT\Windows\PCIe_Driver"

The folder includes the following four files:

- Altera_pcie_win_driver.cat
- Altera_pcie_win_driver.inf
- Altera_pcie_win_driver.sys
- WdfCoinstaller01011.dll

To install the PCI Express driver, please execute the steps below:

1. Connect the Apollo develop kit and the Host PC with Thunderbolt 3 cable.
2. Make sure the Intel Quartus Programmer and USB-Blaster II driver are installed
3. Execute test.bat in "CDROM\Demonstrations\PCIe_DDR4\demo_batch" to configure the FPGA
4. Pull the Thunderbolt3 cable off from the Host, then pull the cable in again for redetect the PCIe device.
5. Click the Control Panel menu from Windows Start menu. Click the Hardware and Sound item before clicking the **Device Manager** to launch the Device Manager dialog. There will be a **PCI Device** item in the dialog, as shown in **Figure 5-3**. Move the mouse cursor to the **PCI**

Device item and right click it to select the Updated Driver Software... items.

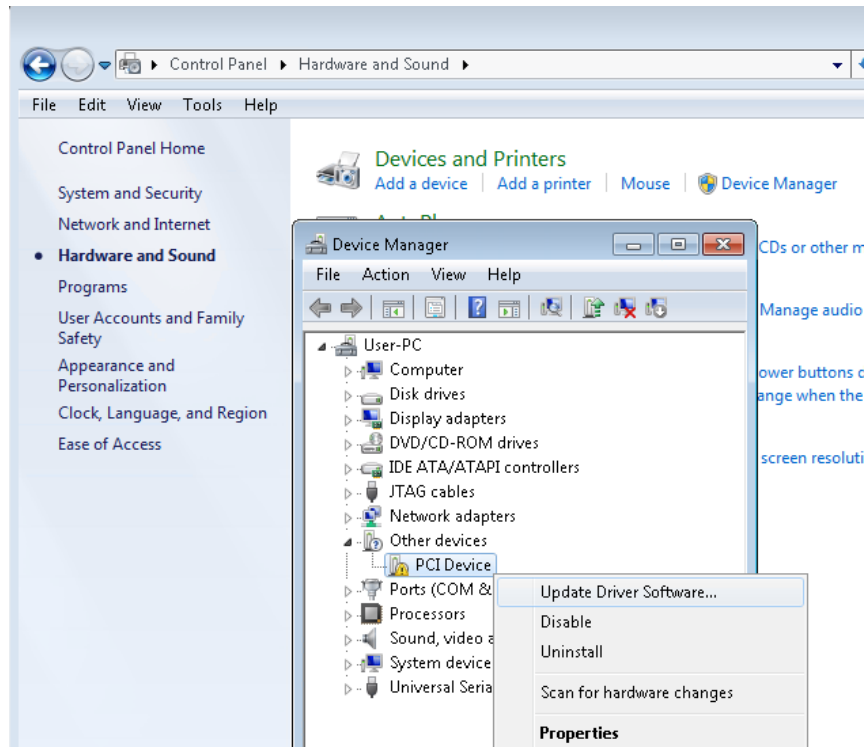

Figure 5-3 Screenshot of launching Update Driver Software... dialog

6. In the **How do you want to search for the driver software** dialog, click **Browse my computer for driver software** item, as shown in **Figure 5-4**.

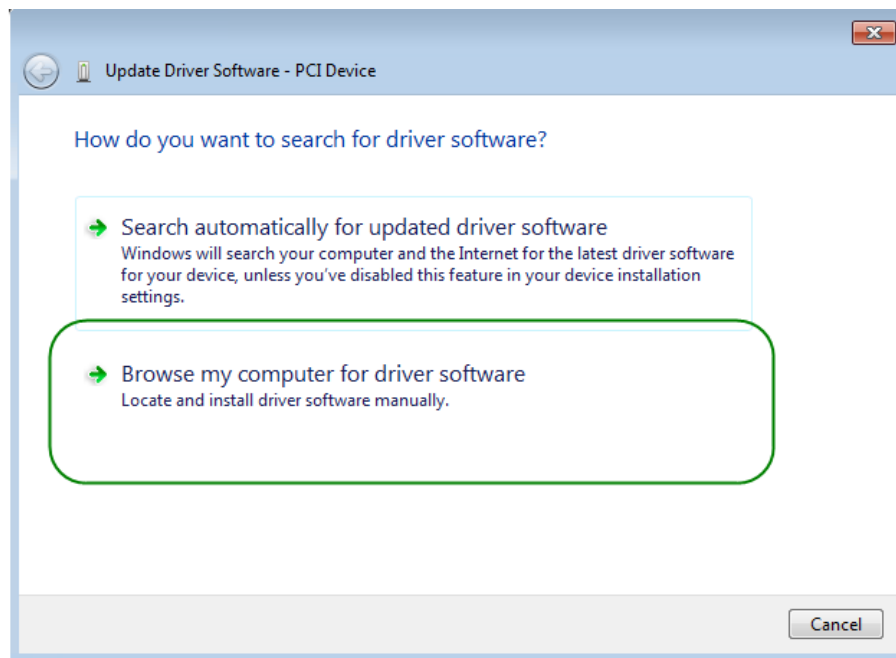

Figure 5-4 Dialog of Browse my computer for the driver software

7. In the **Browse for driver software on your computer** dialog, click the **Browse** button to specify the folder where altera_pcie_din_driver.inf is located, as shown in **Figure 5-5**. Click the **Next** button.

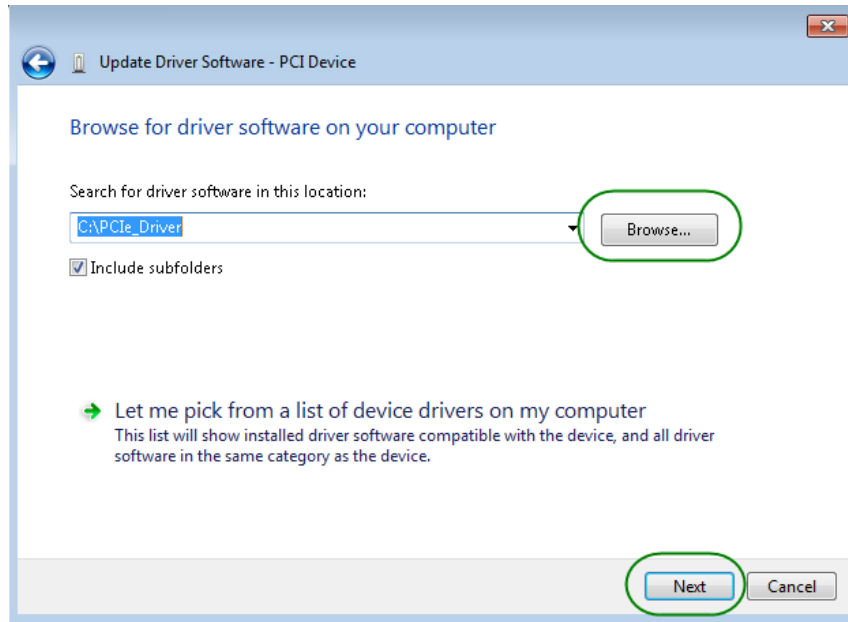

Figure 5-5 Browse for the driver software on your computer

8. When the **Windows Security** dialog appears, as shown **Figure 5-6**, click the **Install** button.

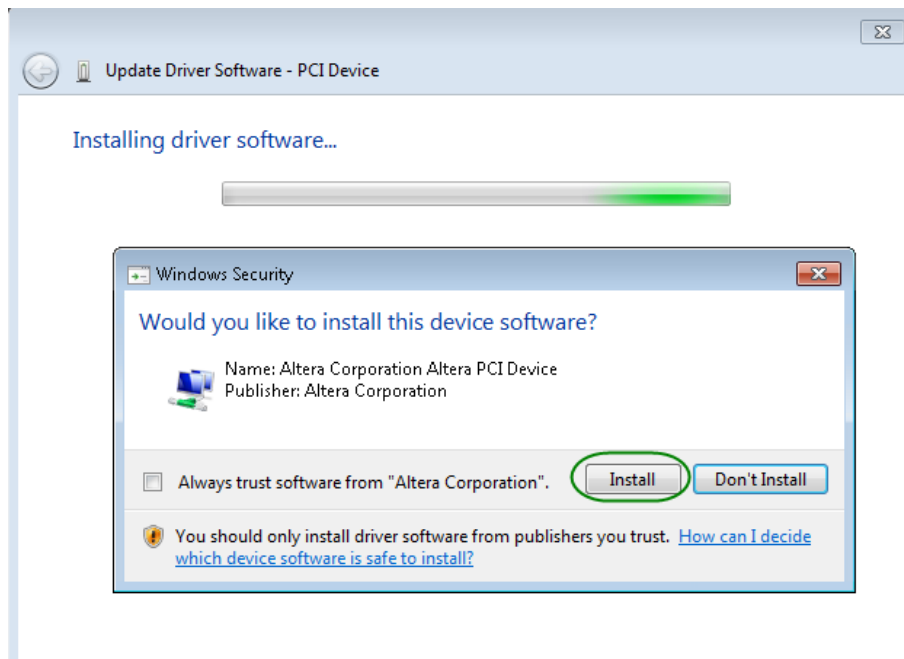

Figure 5-6 Click Install in the dialog of Windows Security

9. When the driver is installed successfully, the successfully dialog will appear, as shown in **Figure 5-7**. Click the **Close** button.

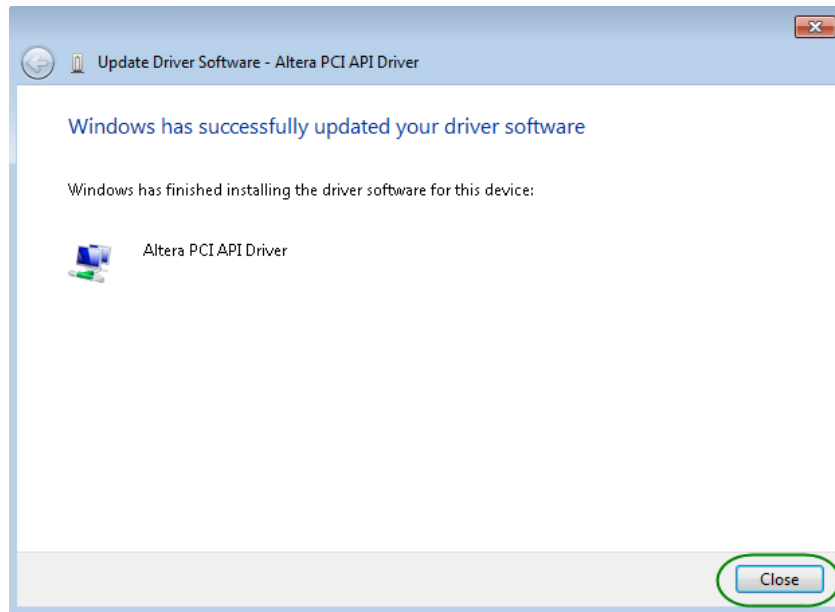

Figure 5-7 Click Close when the installation of the Altera PCI API Driver is complete

10. Once the driver is successfully installed, users can see the **Altera PCI API Driver** under the device manager window, as shown in **Figure 5-8**.

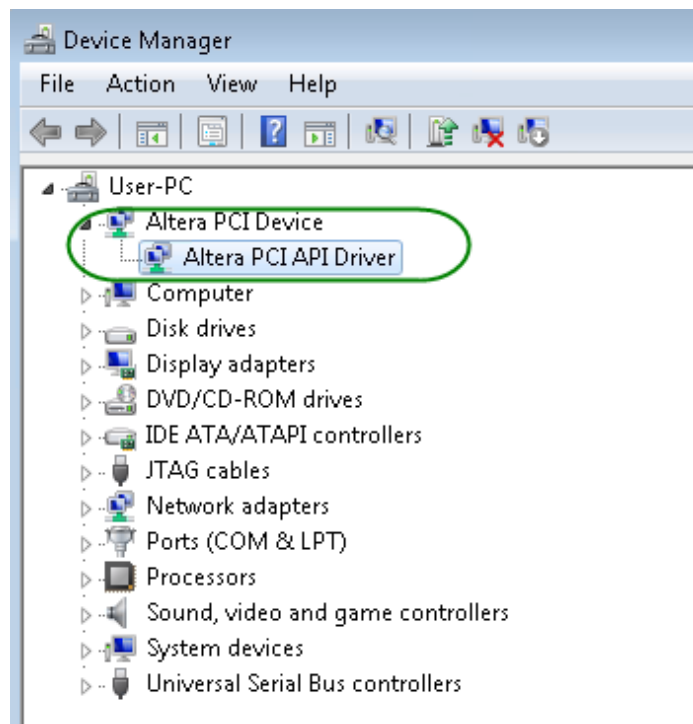

Figure 5-8 Altera PCI API Driver in Device Manager

■ Create a Software Application

All the files needed to create a PCIe software application are located in the directory CDROM\demonstration\PCIe_SW_KIT\Windows\PCIe_Library. It includes the following files:

- TERASIC_PCIE_AVMM.h
- TERASIC_PCIE_AVMM.DLL (64-bit DLL)

Below lists the procedures to use the SDK files in users' C/C++ project :

1. Create a 64-bit C/C++ project.
2. Include TERASIC_PCIE_AVMM.h in the C/C++ project.
3. Copy TERASIC_PCIE_AVMM.DLL to the folder where the project.exe is located.
4. Dynamically load TERASIC_PCIE_AVMM.DLL in C/C++ program. To load the DLL, please refer to the PCIe fundamental example below.
5. Call the SDK API to implement the desired application.

Users can easily communicate with the FPGA through the PCIe bus through the TERASIC_PCIE_AVMM.DLL API. The details of API are described below:

5.4 PCI Express Library API

Below shows the exported API in the TERASIC_PCIE_AVMM.DLL. The API prototype is defined in the TERASIC_PCIE_AVMM.h.

Note: the Linux library terasic_pcie_qsys.so also use the same API and header file.

■ PCIE_Open

Function: Open a specified PCIe card with vendor ID, device ID, and matched card index.
Prototype: PCIE_HANDLE PCIE_Open(uint8_t wVendorID, uint8_t wDeviceID, uint8_t wCardIndex);
Parameters: wVendorID: Specify the desired vendor ID. A zero value means to ignore the vendor ID. wDeviceID: Specify the desired device ID. A zero value means to ignore the device ID. wCardIndex: Specify the matched card index, a zero based index, based on the matched vendor ID and

device ID.

Return Value:

Return a handle to presents specified PCIe card. A positive value is return if the PCIe card is opened successfully. A value zero means failed to connect the target PCIe card. This handle value is used as a parameter for other functions, e.g. PCIE_Read32. Users need to call PCIE_Close to release handle once the handle is no longer used.

■ PCIE_Close

Function:

Close a handle associated to the PCIe card.

Prototype:

```
void PCIE_Close(  
    PCIE_HANDLE hPCIE);
```

Parameters:

hPCIE:
A PCIe handle return by PCIE_Open function.

Return Value:

None.

■ PCIE_Read32

Function:

Read a 32-bit data from the FPGA board.

Prototype:

```
bool PCIE_Read32(  
    PCIE_HANDLE hPCIE,  
    PCIE_BAR PcieBar,  
    PCIE_ADDRESS PcieAddress,  
    uint32_t *pdwData);
```

Parameters:

hPCIE:
A PCIe handle return by PCIE_Open function.

PcieBar:
Specify the target BAR.

PcieAddress:
Specify the target address in FPGA.

pdwData:
A buffer to retrieve the 32-bit data.

Return Value:

Return **true** if read data is successful; otherwise **false** is returned.

■ PCIE_Write32

Function:

Write a 32-bit data to the FPGA Board.

Prototype:

```
bool PCIE_Write32(  
    PCIE_HANDLE hPCIE,  
    PCIE_BAR PcieBar,  
    PCIE_ADDRESS PcieAddress,  
    uint32_t dwData);
```

Parameters:

hPCIE:

A PCIe handle return by PCIE_Open function.

PcieBar:

Specify the target BAR.

PcieAddress:

Specify the target address in FPGA.

dwData:

Specify a 32-bit data which will be written to FPGA board.

Return Value:

Return **true** if write data is successful; otherwise **false** is returned.

■ PCIE_Read8

Function:

Read an 8-bit data from the FPGA board.

Prototype:

```
bool PCIE_Read8(  
    PCIE_HANDLE hPCIE,  
    PCIE_BAR PcieBar,  
    PCIE_ADDRESS PcieAddress,  
    uint8_t *pByte);
```

Parameters:

hPCIE:

A PCIe handle return by PCIE_Open function.

PcieBar:

Specify the target BAR.

PcieAddress:

Specify the target address in FPGA.

pByte:

A buffer to retrieve the 8-bit data.

Return Value:

Return **true** if read data is successful; otherwise **false** is returned.

■ PCIE_Write8

Function:

Write an 8-bit data to the FPGA Board.

Prototype:

```
bool PCIE_Write8(  
    PCIE_HANDLE hPCIE,  
    PCIE_BAR PcieBar,  
    PCIE_ADDRESS PcieAddress,  
    uint8_t Byte);
```

Parameters:

hPCIE:

A PCIe handle return by PCIE_Open function.

PcieBar:

Specify the target BAR.

PcieAddress:

Specify the target address in FPGA.

Byte:

Specify an 8-bit data which will be written to FPGA board.

Return Value:

Return **true** if write data is successful; otherwise **false** is returned.

■ PCIE_DmaRead

Function:

Read data from the memory-mapped memory of FPGA board in DMA.

Maximal read size is (4GB-1) bytes.

Prototype:

```
bool PCIE_DmaRead(  
    PCIE_HANDLE hPCIE,  
    PCIE_LOCAL_ADDRESS LocalAddress,  
    void *pBuffer,  
    uint32_t dwBufSize  
);
```

Parameters:

hPCIE:

A PCIe handle return by PCIE_Open function.

LocalAddress:

Specify the target memory-mapped address in FPGA.

pBuffer:

A pointer to a memory buffer to retrieved the data from FPGA. The size of buffer should be equal or larger the dwBufSize.

dwBufSize:

Specify the byte number of data retrieved from FPGA.

Return Value:

Return **true** if read data is successful; otherwise **false** is returned.

■ PCIE_DmaWrite

Function:

Write data to the memory-mapped memory of FPGA board in DMA.

Prototype:

```
bool PCIE_DmaWrite(  
    PCIE_HANDLE hPCIE,  
    PCIE_LOCAL_ADDRESS LocalAddress,  
    void *pData,  
    uint32_t dwDataSize  
);
```

Parameters:

hPCIE:

A PCIe handle return by PCIE_Open function.

LocalAddress:

Specify the target memory mapped address in FPGA.

pData:

A pointer to a memory buffer to store the data which will be written to FPGA.

dwDataSize:

Specify the byte number of data which will be written to FPGA.

Return Value:

Return **true** if write data is successful; otherwise **false** is returned.

■ PCIE_ConfigRead32

Function:

Read PCIe Configuration Table. Read a 32-bit data by given a byte offset.

Prototype:

```
bool PCIE_ConfigRead32 (
```

```
PCIE_HANDLE hPCIE,  
uint32_t Offset,  
uint32_t *pdwData  
);
```

Parameters:

hPCIE:

A PCIe handle return by PCIe_Open function.

Offset:

Specify the target byte of offset in PCIe configuration table.

pdwData:

A 4-bytes buffer to retrieve the 32-bit data.

Return Value:

Return **true** if read data is successful; otherwise **false** is returned.

5.5 PCIe Reference Design - DDR4

The application reference design shows how to add the DDR4 Memory Controllers for the on board DDR4A and DDR4B banks into the PCIe Quartus project and perform 16GB data DMA for both SODIMM. Also, this demo shows how to call "PCIe_ConfigRead32" API to check PCIe link status.

■ Demonstration Files Location

The demo file is located in the batch folder:

CDROM\Demonstrations\PCIe_DDR4\demo_batch

The folder includes following files:

- FPGA Configuration File: S10C_top.sof
- Download Batch file: test.bat
- Windows Application Software folder: windows_app, includes
 - ✧ PCIe_DDR4.exe
 - ✧ TERASIC_PCIE_AVMM.dll

■ Demonstration Setup

1. Connect the Apollo develop kit and the Host PC with Thunderbolt 3 cable.
2. Make sure the Intel Quartus Programmer and USB-Blaster II driver are installed.
3. Execute test.bat in "CDROM\Demonstrations\PCIe_DDR4\demo_batch" to configure the FPGA
4. Install the PCIe driver if necessary. The driver is located in the folder:
CDROM\Demonstration\PCIe_SW_KIT\Windows\PCIe_Driver.
5. Pull the Thunderbolt 3 cable off from the Host, then pull the cable in again for redetect the PCIe device
6. Make sure that Windows has detected the FPGA Board by checking the Windows Device Manager as shown in **Figure 5-9**.

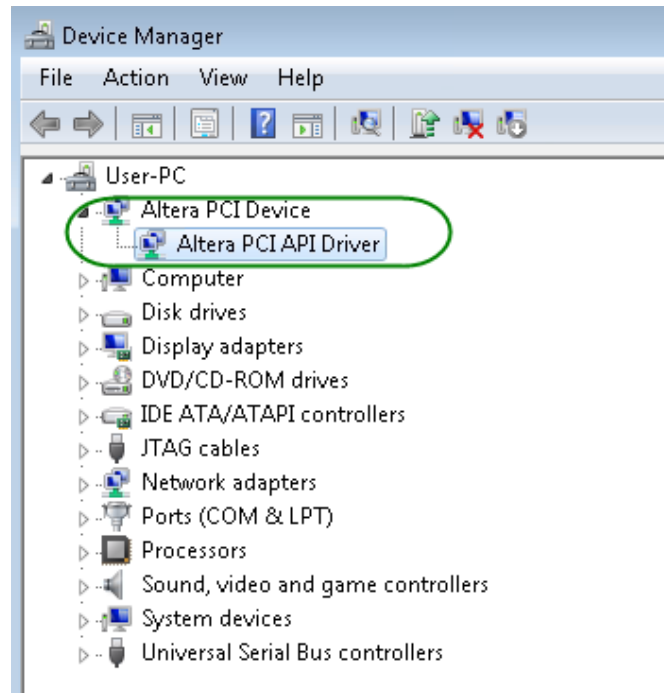

Figure 5-9 Screenshot for PCIe Driver

7. Go to windows_app folder, execute PCIE_DDR4.exe. A menu will appear as shown in **Figure 5-10**.

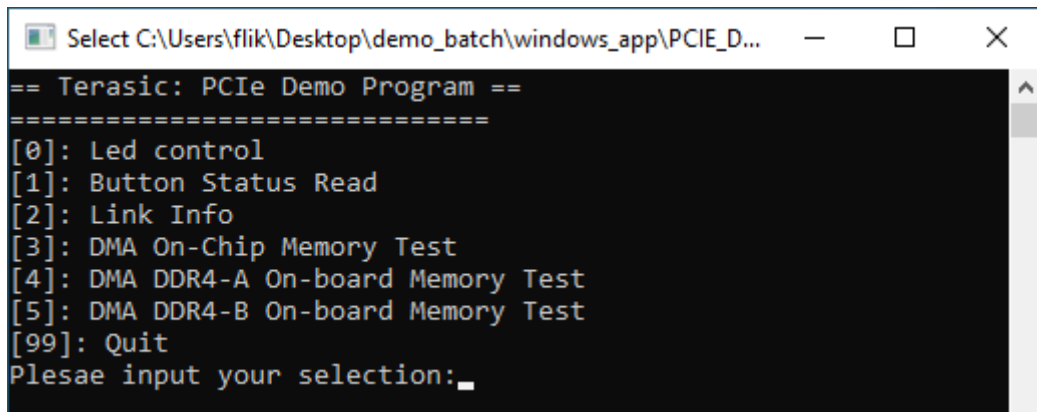

Figure 5-10 Screenshot of Program Menu

8. Type 0 or 1 can control the LED ON/OFF or read the status of the button of the Apollo develop kit.
9. Type 2 followed by the ENTER key to select the Link Info item. The PCIe link information will be shown as in **Figure 5-11**. Gen3 link speed and x3 link width are expected.

```
C:\Users\flik\Desktop\demo_batch\windows_app\PCIE_DDR4.exe
[2]: Link Info
[3]: DMA On-Chip Memory Test
[4]: DMA DDR4-A On-board Memory Test
[5]: DMA DDR4-B On-board Memory Test
[99]: Quit
Plesae input your selection:2
Vender ID:1172h
Device ID:E003h
Current Link Speed is Gen3
Negotiated Link Width is x4
Maximum Payload Size is 128-byte
=====
```

Figure 5-11 Screenshot of Link Info

10. Type 3 followed by the ENTER key to select DMA On-Chip Memory Test item. The DMA write and read test result will be reported as shown in **Figure 5-12**.

```
C:\Users\flik\Desktop\demo_batch\windows_app\PCIE_DDR4.exe
[3]: DMA On-Chip Memory Test
[4]: DMA DDR4-A On-board Memory Test
[5]: DMA DDR4-B On-board Memory Test
[99]: Quit
Plesae input your selection:3
DMA Memory Test, Address = 0x0, Size = 0x80000 Bytes...
Generate Test Pattern...
DMA Write...
DMA Read...
Readback Data Verify...
DMA-Memory Address = 0x0, Size = 0x80000 bytes pass
```

Figure 5-12 Screenshot of On-Chip Memory DMA Test Result

11. Type 4 followed by the ENTER key to select the DMA DDR4A Bank Memory Test item. The DMA write and read test result will be reported as shown in **Figure 5-13**.

■ FPGA Application Design

Figure 5-15 shows the system block diagram in the FPGA system. In the **Platform Designer** (formerly Qsys), the PIO controller is used to control the LED and monitor the Button Status, and the On-Chip memory is used for performing DMA testing. The PIO controllers and the On-Chip memory are connected to the PCI Express Hard IP controller through the Memory-Mapped Interface.

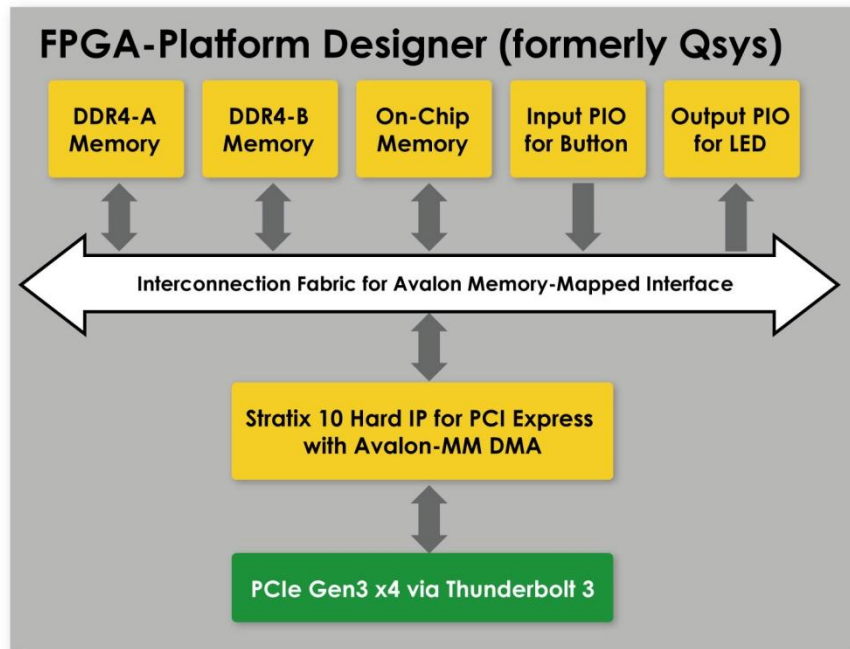

Figure 5-15 Hardware block diagram of the PCIe_DDR4 reference design

■ Windows Based Application Software Design

The application software project is built by Visual C++ 2012. The project includes the following major files:

Name	Description
PCIE_DDR4.cpp	Main program
PCIE.c	Implement dynamically load for
PCIE.h	TERASIC_PCIE_AVMM.DLL
TERASIC_PCIE_AVMM.h	SDK library file, defines constant and data structure

The main program PCIE_DDR4.cpp includes the header file "PCIE.h" and defines the controller address according to the FPGA design.

```

#define DEMO_PCIE_USER_BAR          PCIE_BAR4↓
#define DEMO_PCIE_IO_LED_ADDR       0x4000010↓
#define DEMO_PCIE_IO_BUTTON_ADDR    0x4000020↓
#define DEMO_PCIE_ONCHIP_MEM_ADDR   0x00000000↓
#define DEMO_PCIE_DDR4A_MEM_ADDR    0x100000000↓
#define DEMO_PCIE_DDR4B_MEM_ADDR    0x140000000↓
↓
#define ONCHIP_MEM_TEST_SIZE        (512*1024) //512KB↓
#define DDR4A_MEM_TEST_SIZE         (16ull*1024*1024*1024) //16GB↓
#define DDR4B_MEM_TEST_SIZE         (16ull*1024*1024*1024) //16GB↓
#define DMA_MAX_SIZE                 (4ull*1024*1024*1024 - 4) //4GB - 4B↓
#define DMA_CHUNK_SIZE              (2ull*1024*1024*1024) //2GB↓

```

The base address of BUTTON and LED controllers are 0x4000010 and 0x4000020 based on PCIE_BAR4, respectively. The on-chip memory base address is 0x00000000 relative to the DMA controller. **The above definitions are the same as those in the PCIe Fundamental demo.**

Before accessing the FPGA through PCI Express, the application first calls PCIE_Load to dynamically load the Terasic_PCIE_AVMM.DLL. Then, it calls PCIE_Open to open the PCI Express driver. The constant DEFAULT_PCIE_VID and DEFAULT_PCIE_DID used in the PCIE_Open are defined in Terasic_PCIE_AVMM.h. If developers change the Vendor ID and Device ID and PCI Express IP, they also need to change the ID value defined in Terasic_PCIE_AVMM.h. If the return value of PCIE_Open is zero, it means the driver cannot be accessed successfully. In this case, please make sure:

- The FPGA is configured with the associated bit-stream file and the Host is rebooted.
- The PCI express driver is loaded successfully.

The LED control is implemented by calling PCIE_Write32 API, as shown below:

```
bPass = PCIE_Write32(hPCIE, DEMO_PCIE_USER_BAR, DEMO_PCIE_IO_LED_ADDR, (uint32_t) Mask);
```

The button status query is implemented by calling the **PCIE_Read32** API, as shown below:

```
PCIE_Read32(hPCIE, DEMO_PCIE_USER_BAR, DEMO_PCIE_IO_BUTTON_ADDR, &Status);
```

The memory-mapped memory read and write test is implemented by **PCIE_DmaWrite** and **PCIE_DmaRead** API, as shown below:

```
PCIE_DmaWrite(hPCIE, LocalAddr, pWrite, nTestSize);
PCIE_DmaRead(hPCIE, LocalAddr, pRead, nTestSize);
```

The PCIe link information is implemented by PCIE_ConfigRead32 API, as shown below:

```
// read config - link status
if (PCIE_ConfigRead32(hPCIE, 0x80, &Data32)) {
    switch ((Data32 >> 16) & 0x0F) {
        case 1:
            printf("Current Link Speed is Gen1\r\n");
            break;
        case 2:
            printf("Current Link Speed is Gen2\r\n");
            break;
        case 3:
            printf("Current Link Speed is Gen3\r\n");
            break;
        default:
            printf("Current Link Speed is Unknown\r\n");
            break;
    }
    switch ((Data32 >> 20) & 0x3F) {
        case 1:
            printf("Negotiated Link Width is x1\r\n");
            break;
        case 2:
            printf("Negotiated Link Width is x2\r\n");
            break;
        case 4:
            printf("Negotiated Link Width is x4\r\n");
            break;
        case 8:
            printf("Negotiated Link Width is x8\r\n");
            break;
        case 16:
            printf("Negotiated Link Width is x16\r\n");
            break;
        default:
            printf("Negotiated Link Width is Unknown\r\n");
            break;
    }
} else {
    bPass = false;
}
```

Chapter 6

Transceiver Verification

This chapter describes how to verify the FPGA transceivers via the QSFP28 connector. A 40Gbps loopback test code called `alt_e40` which is available in the System CD. The source code is also available in the in the system CD.

6.1 Transceiver Test Code

The transceiver test code is used to verify the transceiver channels via the QSPF28 ports through an external loopback method. The transceiver channels are verified with the data rates 10.3125 Gbps for the FPGA with PRBS31 test pattern.

6.2 QSFP28 Ports

To enable an external loopback of the transceiver channels, QSFP28 loopback fixtures, as shown in **Figure 6-1**, are required. The fixture is available at:

<https://multilaneinc.com/product/ml4002-28/>



Figure 6-1 QSFP28 Loopback fixtures

Figure 6-2 shows the FPGA board with four QSFP28 loopback fixtures installed.



Figure 6-2 QSFP28 Loopback fixtures in the Apollo Develop kit

6.3 40G Ethernet Example

This 40G Ethernet example is generated according to the documents [Stratix 10 Low Latency 40G Ethernet Design Example User Guide](#). The Stratix 10 LL(Low Latency) 40GbE IP is used in the example design. This example executes the external loopback test through one of the QSFP28 ports on the FPGA main board. A QSFP28 loopback fixture is required to perform this demonstration. **Figure 6-3** shows the block diagram of this demonstration.

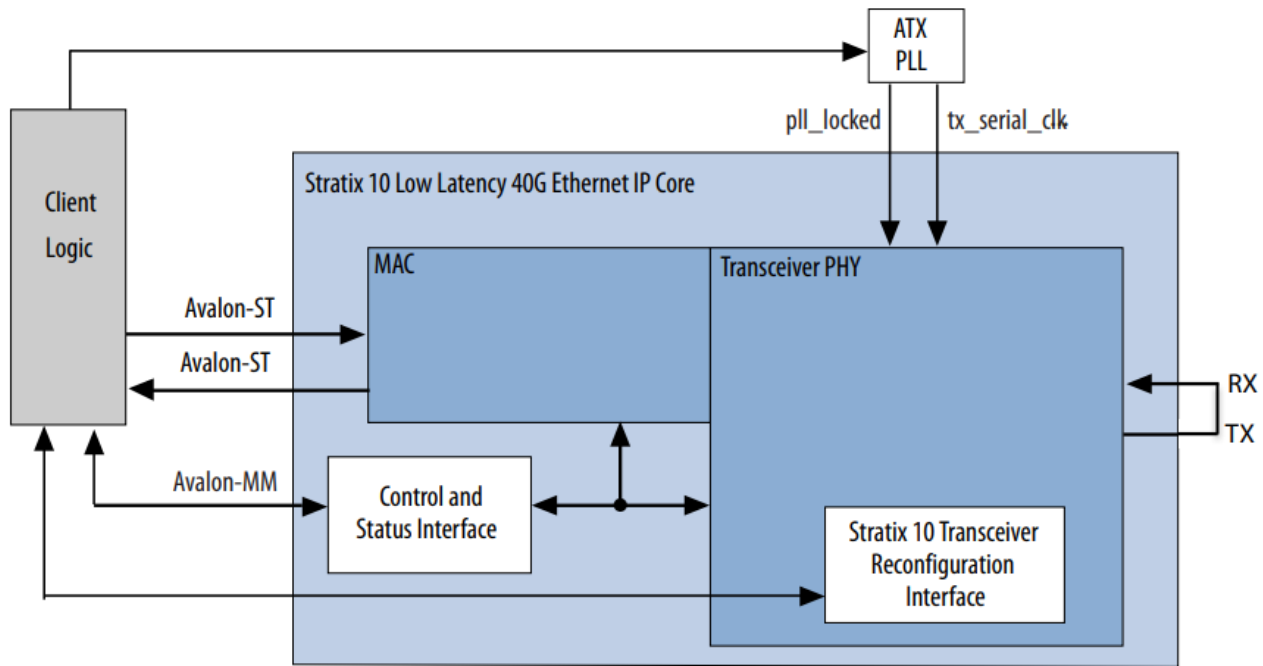

Figure 6-3 Block diagram of 40GbE demo

■ Project Information

The Project information is shown in the table below.

Item	Description
Project Location	CDROM/Demonstrations/alt_e40
Quartus Project	CDROM/Demonstrations/alt_e40/hardware_test_design
FPGA Bit Stream	CDROM/Demonstrations/alt_e40/hardware_test_design/output_files/eth_ex_40g.sof
Demo Batch	CDROM/Demonstrations/alt_e40/demo_batch
Test Scrip File	CDROM/Demonstrations/alt_e40/hardware_test_design/hwtest/main.tcl
Quartus Version	Quartus Prime 19.4 Pro Edition

■ Demonstration Setup

Here is the procedure to setup the demonstration. A QSFP28 loopback fixture is required for this demonstration. If you don't have a QSFP28 loopback fixture, please use `run_test` instead of `run_external_test` in the following demonstration procedure. The `run_test` is used to enable transceiver serial loopback for internal loopback.

1. Make sure your Host PC has installed the Quartus 19.4 Pro edition.
2. Insert a QSFP28 loopback fixture into the QSFP28-A port on the Apollo carrier board, as shown in **Figure 6-2**.

3. Connect the Host PC to the FPGA board using a mini-USB cable. Please make sure the USB-Blaster II driver is installed on the Host PC.
4. Make sure the USB-Blaster II is detected correctly.
5. Go to the path: *System_CD/Demonstration/alt_e40/demo_batch/*. Execute the batch file “**test.bat**” to program the FPGA and run the Tcl file (See **Figure 6-4**). The Tcl file will open the Quartus tool “**System Console**” automatically(See **Figure 6-5**).

```

Select C:\Windows\system32\cmd.exe
*****
Please select a ALT_E40 Port for testing
"1" for ALT_E40
Note, make sure loopback fixtures are installed.
*****
Please enter your choice: [1]?1
Warning (19729): Current CMF data structure hash (0xA2C420AC) is older version than latest CMF
data structure but still allowable.
This might be transition period. You should update your CMF to latest version with hash { 0x96
03E739 } [Add operation to send JTAG ID to LSM]
Info (19848): Regular SEU info => 105 sector(s), 8 thread(s), 25200 interval time in microseco
nd(s)
Info (19848): IO hash is 4441D0ECD116043DDBA5DFF09F3BCB5D21B7F3DFF516507F3107ED5D21501B57
Info (19848): Design hash is 24C99317285858771CABE904A045DCD062EFE1DE3C8B435E712F88DBC2D06F01
Info (19848): IO hash is 4441D0ECD116043DDBA5DFF09F3BCB5D21B7F3DFF516507F3107ED5D21501B57
Info: *****
Info: Running Quartus Prime Programmer
Info: Version 19.4.0 Build 64 12/04/2019 SC Pro Edition
Info: Copyright (C) 2019 Intel Corporation. All rights reserved.
Info: Your use of Intel Corporation's design tools, logic functions
Info: and other software and tools, and any partner logic
Info: functions, and any output files from any of the foregoing
Info: (including device programming or simulation files), and any
Info: associated documentation or information are expressly subject
Info: to the terms and conditions of the Intel Program License
Info: Subscription Agreement, the Intel Quartus Prime License Agreement,
Info: the Intel FPGA IP License Agreement, or other applicable license

```

Figure 6-4 Execute demo batch file

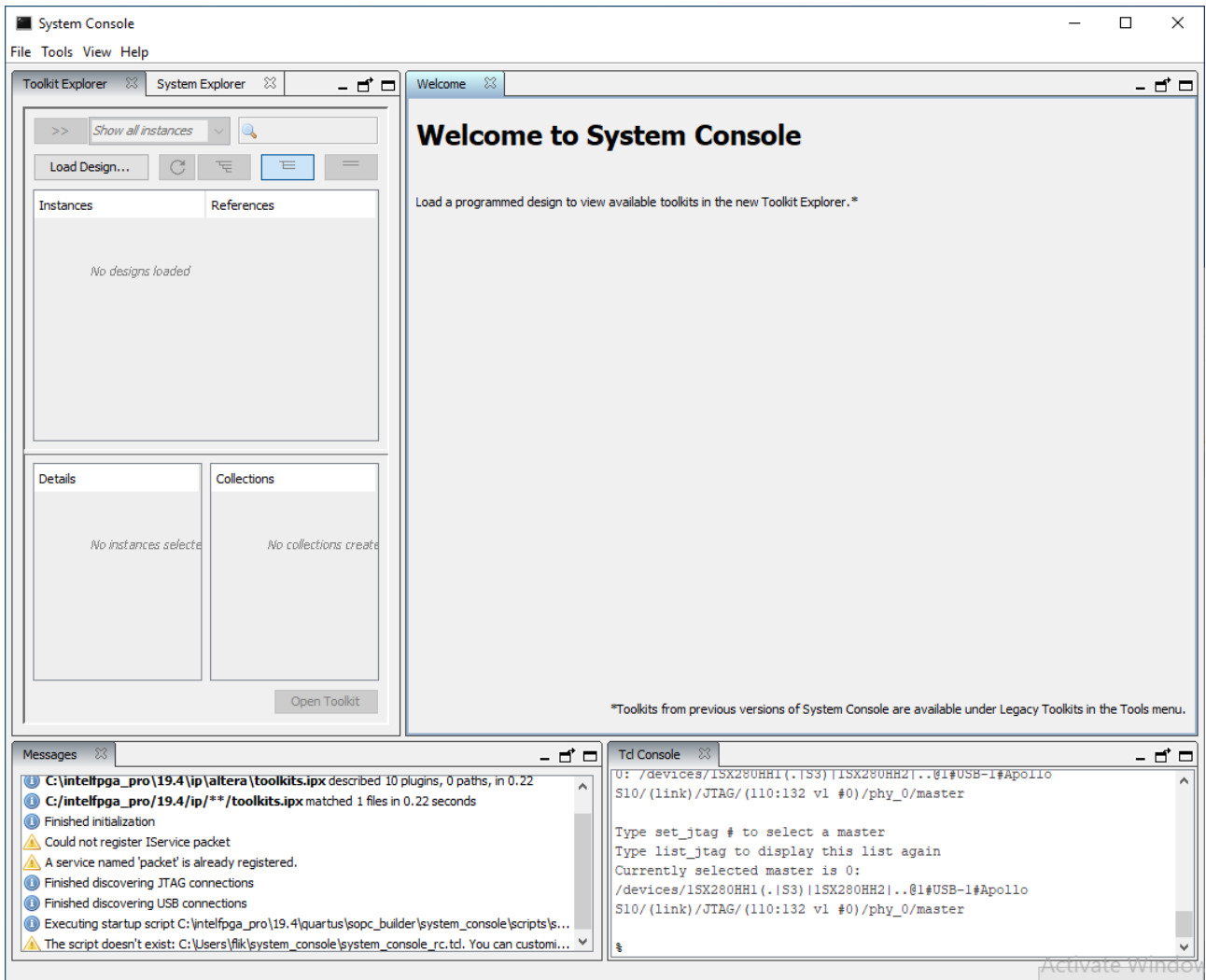

Figure 6-5 Launch the System Console for Ethernet 40G Demo

6. If you have a QSFP28 loopback fixture installed, type “**loop_off**” to turns off internal serial loopback. Otherwise, type “**loop_on**” to turn on internal serial loopback(See [Figure 6-6](#)).

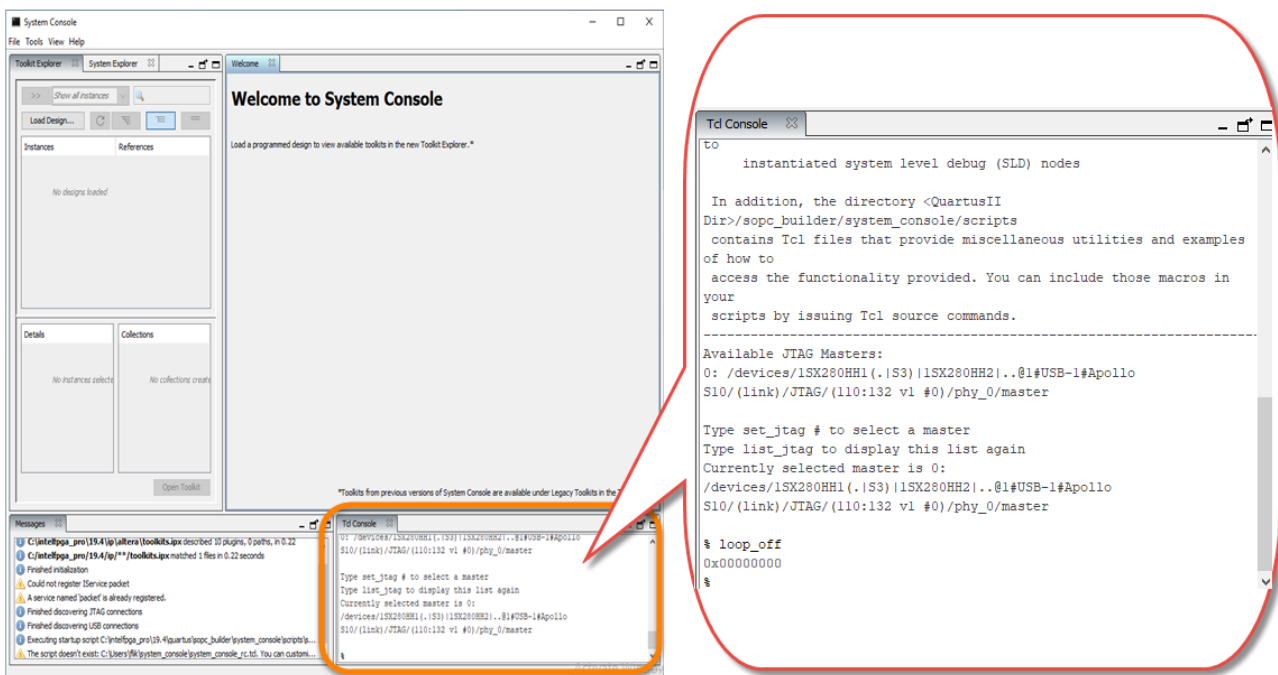

Figure 6-6 Enter command for test

7. Type **“start_pkt_gen”** to starts the packet generator.
8. Type **“chkmac_stats”** to display the values in the MAC statics counters, as shown in **Figure 6-7**.

```

Td Console  X
=====
                                STATISTICS FOR BASE 0x0900 (Rx)
=====
Fragmented Frames                : 0
Jabbered Frames                  : 0
Any Size with FCS Err Frame     : 0
Right Size with FCS Err Fra     : 0
Multicast data Err Frames       : 0
Broadcast data Err Frames       : 0
Unicast data Err Frames         : 0
Multicast control Err Frame     : 0
Broadcast control Err Frame     : 0
Unicast control Err Frames     : 0
Pause control Err Frames        : 0
64 Byte Frames                  : 9127
65 - 127 Byte Frames            : 8982
128 - 255 Byte Frames           : 18150
256 - 511 Byte Frames           : 36105
512 - 1023 Byte Frames          : 71774
1024 - 1518 Byte Frames         : 69033
1519 - MAX Byte Frames          : 2087919
> MAX Byte Frames               : 0
Rx Frame Starts                  : 0
Multicast data OK Frame         : 0
Broadcast data OK Frame         : 0
Unicast data OK Frames          : 2301090
Multicast Control Frames        : 0
Broadcast Control Frames        : 0
Unicast Control Frames          : 0
Pause Control Frames            : 0
Payload Octets OK               : 15575116140
Frame Octets OK                 : 15616535760
=====

```

```

Td Console  X
=====
                                STATISTICS FOR BASE 0x0800 (Tx)
=====
Fragmented Frames                : 0
Jabbered Frames                  : 0
Any Size with FCS Err Frame     : 0
Right Size with FCS Err Fra     : 0
Multicast data Err Frames       : 0
Broadcast data Err Frames       : 0
Unicast data Err Frames         : 0
Multicast control Err Frame     : 0
Broadcast control Err Frame     : 0
Unicast control Err Frames     : 0
Pause control Err Frames        : 0
64 Byte Frames                  : 9318
65 - 127 Byte Frames            : 9145
128 - 255 Byte Frames           : 18549
256 - 511 Byte Frames           : 36810
512 - 1023 Byte Frames          : 73231
1024 - 1518 Byte Frames         : 70453
1519 - MAX Byte Frames          : 2130508
> MAX Byte Frames               : 0
Tx Frame Starts                  : 0
Multicast data OK Frame         : 0
Broadcast data OK Frame         : 0
Unicast data OK Frames          : 2348014
Multicast Control Frames        : 0
Broadcast Control Frames        : 0
Unicast Control Frames          : 0
Pause Control Frames            : 0
Payload Octets OK               : 15892525206
Frame Octets OK                 : 15934789458
0
$
=====

```

Figure 6-7 Ethernet 40G loopback test report for RX and TX

Chapter 7

Additional Information

7.1 Getting Help

Here are the addresses where you can get help if you encounter problems:

■ Terasic Technologies

9F., No.176, Sec.2, Gongdao 5th Rd,
East Dist, HsinChu City, Taiwan, 30070

Email: support@terasic.com

Web: www.terasic.com

■ Revision History

Date	Version	Changes
2020.04	First publication	
2020.04	V1.1	Add chapter 5 &6
2020.05	V1.2	Add assemble and disassemble board video in chapter 3
2020.06	V1.3	Fix some description error
2020.09	V1.4	Fix some description error

Mouser Electronics

Authorized Distributor

Click to View Pricing, Inventory, Delivery & Lifecycle Information:

[Terasic:](#)

[P0671](#)