

Data sheet | Item number: 857-724

Solid-state relay module; Nominal input voltage: 24 VDC; Output voltage range: 0 ... 24 VDC; Limiting continuous current: 3 A; 2-wire connection; Yellow status indicator; Module width: 6 mm; gray

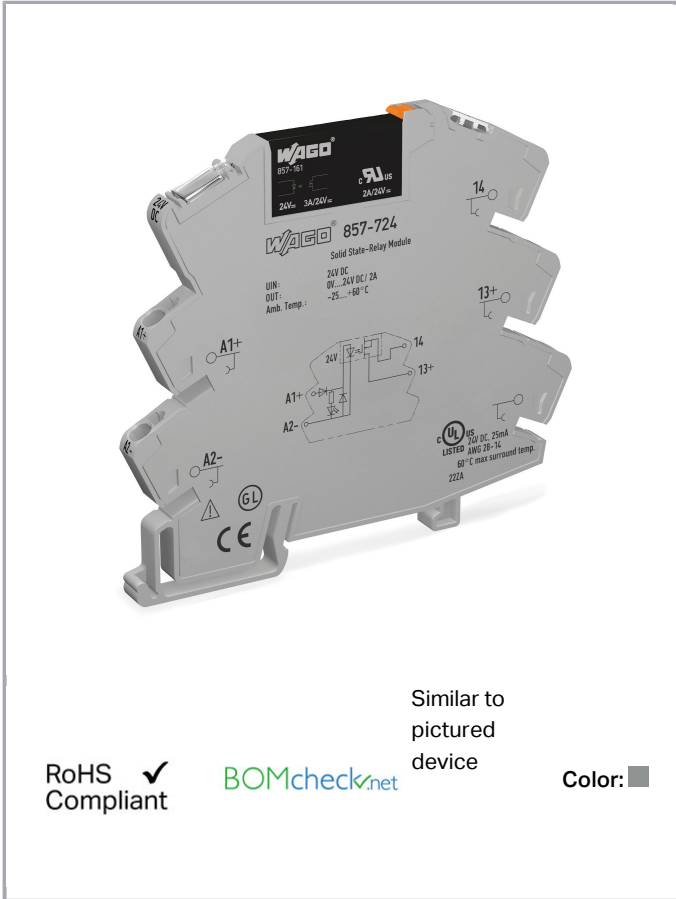

www.wago.com/857-724



Similar to
pictured
device

RoHS
Compliant

BOMcheck.net

Color: ■

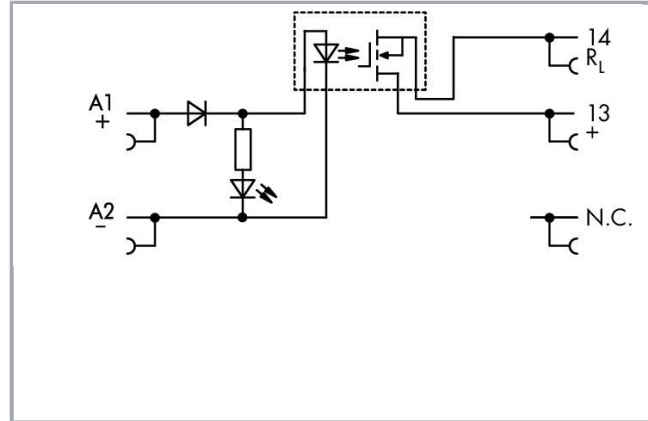

Subject to changes. Please also observe the further product documentation!

WAGO Kontakttechnik GmbH & Co. KG
Hansastr. 27
32423 Minden
Phone: +49571 887-0 | Fax: +49571 887-169
Email: info.de@wago.com | Web: www.wago.com

Do you have any questions about our products?
We are always happy to take your call at +49 (571) 887-44222.

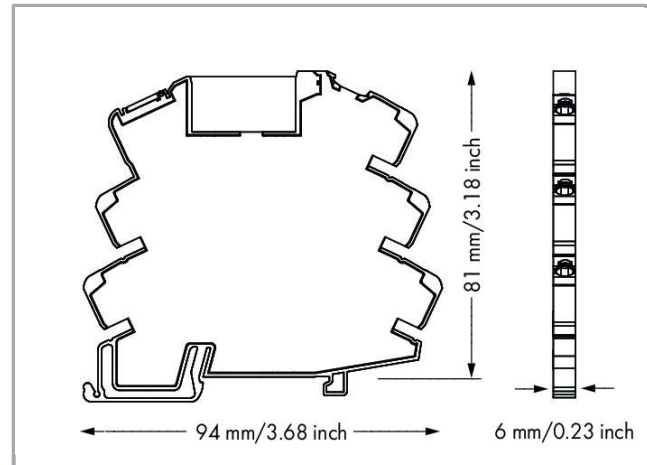
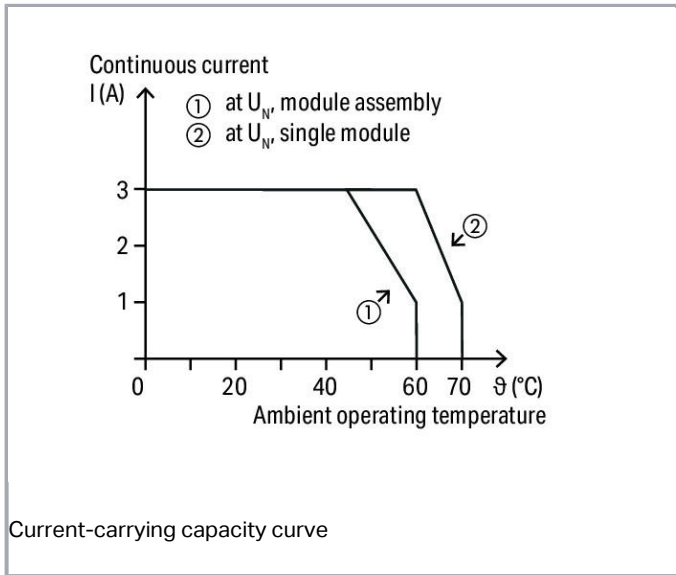

Item description

Note:

Optocouplers and solid state relays are designed for use in signal processing networks, which are not supplied by the low-voltage power supply networks.

Data

Technical Data

Control circuit

| | |
|----------------------------------|--------------------|
| Nominal input voltage U_N | DC 24 V |
| Input voltage range (low level) | DC 0 ... 10 V |
| Input voltage range (high level) | DC 18,8 ... 31,2 V |
| Nominal input current at U_N | 9,2 mA |

Load circuit:

| | |
|-----------------------------------|--------------------|
| Circuit type | 2-wire connection |
| Limiting continuous current | 3 A |
| Inrush current (resistive) (max.) | (AC) 15 A / 0,01 s |
| Nominal output voltage | DC 24 V |
| Output voltage range | DC 0 ... 30 V |

Subject to changes. Please also observe the further product documentation!



| | |
|----------------------------------|-------------|
| Voltage drop at output (max.) | ≤ DC 0,12 V |
| Leakage current at rated voltage | ≤ 1 μA |
| Switching current (min.) | 50 μA |
| Turn-on time | ≤ 100 μs |
| Turn-off time | ≤ 600 μs |
| Switching frequency | ≤ 350 Hz |

Signaling

| | |
|------------------|------------|
| Status indicator | Yellow LED |
|------------------|------------|

Safety and protection:

| | |
|---|------------|
| Dielectric strength, control/load circuit (AC, 1 min) | 3,75 kVrms |
| Protection type | IP20 |

Connection data

| | |
|-------------------------|--|
| Connection technology | Push-in CAGE CLAMP® |
| Solid conductor | 0,34 ... 2,5 mm ² / 22 ... 14 AWG |
| Fine-stranded conductor | 0,34 ... 2,5 mm ² / 22 ... 14 AWG |
| Strip length | 9 ... 10 mm / 0.35 ... 0.39 inch |

Geometrical Data

| | |
|------------------------------------|--------------------|
| Width | 6 mm / 0.236 inch |
| Height from upper-edge of DIN-rail | 81 mm / 3.189 inch |
| Depth | 94 mm / 3.701 inch |

Mechanical data

| | |
|---------------|-------------|
| Mounting type | DIN-35 rail |
|---------------|-------------|

Material Data

| | |
|-----------|----------|
| Color | gray |
| Fire load | 0.149 MJ |
| Weight | 28.4 g |

Subject to changes. Please also observe the further product documentation!

Environmental Requirements

| | |
|---|----------------|
| Surrounding air temperature (operation at U_N) | -20 ... 70 °C |
| Surrounding air temperature (storage) | -40 ... 70 °C |
| Processing temperature | -25 ... +50 °C |

Standards and specifications

| | |
|--------------------------|--|
| Standards/specifications | EN 61000-6-2; EN 61000-6-3; EN 61373; EN 61010-2-201; UL 508; GL |
|--------------------------|--|

Elementary relay



| | |
|------------------|---------|
| WAGO Basic Relay | 857-161 |
|------------------|---------|

Commercial data

| | |
|-----------------------|---------------------------|
| Product Group | 6 (Interface Electronics) |
| Packaging type | BOX |
| Country of origin | CN |
| GTIN | 4045454835552 |
| Customs tariff number | 85365005000 |

Approvals / Certificates

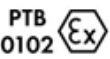
Ex-Approvals

| Logo | Approval | Additional Approval Text | Certificate name |
|--|--------------------------|--------------------------|---------------------|
|  | ATEX DEKRA EXAM GmbH | EN 60079-0 | BVS_14_ATEX_E_091_X |
|  | IECEX DEKRA EXAM GmbH | IEC 60079-0 | IECEX_BVS_14.0079_X |

Ship Approvals

| Logo | Approval | Additional Approval Text | Certificate name |
|------|---------------------------|--------------------------|------------------|
| | BV Bureau Veritas S.A. | - | 40179_A0 |

Subject to changes. Please also observe the further product documentation!

BUREAU
VERITAS

DNV GL

Det Norske Veritas, Germanischer Lloyd

-

TAA00001D1



NK

Nippon Kaiji Kyokai

-

TA17255M



PRS

Polski Rejestr Statków

-

TE/2186
/880590/18



UL-Approvals

| Logo | Approval | Additional Approval Text | Certificate name |
|---|--|--------------------------|------------------|
|  | UL UL International Netherlands B.V. (ORDINARY LOCATIONS) | UL 508 | E175199 Sec.4 |

Counterpart

Compatible products

General accessories

| | | |
|--|---|--|
|  | Item no.: 209-184 Protection cover; transparent | www.wago.com/209-184 |
|  | Item no.: 857-161 Basic solid-state relay; Nominal input voltage: 24 VDC; Output voltage range: 0 ... 24 VDC; Limiting continuous current: 3 A | www.wago.com/857-161 |















Marking accessories

Item no.: 2009-110

Subject to changes. Please also observe the further product documentation!

WAGO Kontakttechnik GmbH & Co. KG
Hansastr. 27
32423 Minden
Phone: +49571 887-0 | Fax: +49571 887-169
Email: info.de@wago.com | Web: www.wago.com

Do you have any questions about our products?
We are always happy to take your call at +49 (571) 887-44222.

| | | |
|--|---|--|
|  | Marking strips; on reel; not stretchable; plain; snap-on type; white | www.wago.com/2009-110 |
|  | Item no.: 2009-115 WMB-Inline; for Smart Printer; 1500 pieces on roll; stretchable 5 - 5.2 mm; plain; snap-on type; white | www.wago.com/2009-115 |
|  | Item no.: 2009-115/000-002 WMB-Inline; for Smart Printer; 1500 pieces on roll; stretchable 5 - 5.2 mm; plain; snap-on type; yellow | www.wago.com/2009-115/000-002 |
|  | Item no.: 2009-115/000-006 WMB-Inline; for Smart Printer; 1500 pieces on roll; stretchable 5 - 5.2 mm; plain; snap-on type; blue | www.wago.com/2009-115/000-006 |
|  | Item no.: 2009-115/000-007 WMB-Inline; for Smart Printer; 1500 pieces on roll; stretchable 5 - 5.2 mm; plain; snap-on type; gray | www.wago.com/2009-115/000-007 |
|  | Item no.: 2009-115/000-012 WMB-Inline; for Smart Printer; 1500 pieces on roll; stretchable 5 - 5.2 mm; plain; snap-on type; orange | www.wago.com/2009-115/000-012 |
|  | Item no.: 2009-115/000-017 WMB-Inline; for Smart Printer; 1500 pieces on roll; stretchable 5 - 5.2 mm; plain; snap-on type; light green | www.wago.com/2009-115/000-017 |
|  | Item no.: 2009-115/000-023 WMB-Inline; for Smart Printer; 1500 pieces on roll; stretchable 5 - 5.2 mm; plain; snap-on type; green | www.wago.com/2009-115/000-023 |
|  | Item no.: 2009-115/000-024 WMB-Inline; for Smart Printer; 1500 pieces on roll; stretchable 5 - 5.2 mm; plain; snap-on type; violet | www.wago.com/2009-115/000-024 |
|  | Item no.: 209-128 Adaptor; gray | www.wago.com/209-128 |
|  | Item no.: 209-183 Marker card; white | www.wago.com/209-183 |
|  | Item no.: 210-110 Fiber-tip pen | www.wago.com/210-110 |
|  | Item no.: 249-105 Group marker carrier; gray | www.wago.com/249-105 |
|  | Item no.: 793-501 WMB marking card; as card; not stretchable; plain; snap-on type; white | www.wago.com/793-501 |
|  | Item no.: 793-501/000-002 WMB marking card; as card; not stretchable; plain; snap-on type; yellow | www.wago.com/793-501/000-002 |

Subject to changes. Please also observe the further product documentation!



Item no.: 793-501/000-005
WMB marking card; as card; not stretchable; plain; snap-on type; red

www.wago.com/793-501/000-005



Item no.: 793-501/000-006
WMB marking card; as card; not stretchable; plain; snap-on type; blue

www.wago.com/793-501/000-006



Item no.: 793-501/000-007
WMB marking card; as card; not stretchable; plain; snap-on type; gray

www.wago.com/793-501/000-007



Item no.: 793-501/000-012
WMB marking card; as card; not stretchable; plain; snap-on type; orange

www.wago.com/793-501/000-012



Item no.: 793-501/000-017
WMB marking card; as card; not stretchable; plain; snap-on type; light green

www.wago.com/793-501/000-017



Item no.: 793-501/000-023
WMB marking card; as card; not stretchable; plain; snap-on type; green

www.wago.com/793-501/000-023



Item no.: 793-501/000-024
WMB marking card; as card; not stretchable; plain; snap-on type; violet

www.wago.com/793-501/000-024



Item no.: 793-502
WMB marking card; as card; MARKED; 1 ... 10 (10x); not stretchable; Horizontal marking; snap-on type; white

www.wago.com/793-502



Item no.: 793-502/000-002
WMB marking card; as card; MARKED; 1 ... 10 (10x); not stretchable; Horizontal marking; snap-on type; yellow

www.wago.com/793-502/000-002



Item no.: 793-502/000-005
WMB marking card; as card; MARKED; 1 ... 10 (10x); not stretchable; Horizontal marking; snap-on type; red

www.wago.com/793-502/000-005



Item no.: 793-502/000-006
WMB marking card; as card; MARKED; 1 ... 10 (10x); not stretchable; Horizontal marking; snap-on type; blue

www.wago.com/793-502/000-006



Item no.: 793-502/000-007
WMB marking card; as card; MARKED; 1 ... 10 (10x); not stretchable; Horizontal marking; snap-on type; gray

www.wago.com/793-502/000-007



Item no.: 793-502/000-012
WMB marking card; as card; MARKED; 1 ... 10 (10x); not stretchable; Horizontal marking; snap-on type; orange

www.wago.com/793-502/000-012



Item no.: 793-502/000-017
WMB marking card; as card; MARKED; 1 ... 10 (10x); not stretchable; Horizontal marking; snap-on type;

www.wago.com/793-502/000-017

Subject to changes. Please also observe the further product documentation!

light green

**Item no.: 793-502/000-023**

WMB marking card; as card; MARKED; 1 ... 10 (10x); not stretchable; Horizontal marking; snap-on type; green

www.wago.com/793-502/000-023**Item no.: 793-502/000-024**

WMB marking card; as card; MARKED; 1 ... 10 (10x); not stretchable; Horizontal marking; snap-on type; violet

www.wago.com/793-502/000-024**Item no.: 793-503**

WMB marking card; as card; MARKED; 11 ... 20 (10x); not stretchable; Horizontal marking; snap-on type; white

www.wago.com/793-503**Item no.: 793-503/000-002**

WMB marking card; as card; MARKED; 11 ... 20 (10x); not stretchable; Horizontal marking; snap-on type; yellow

www.wago.com/793-503/000-002**Item no.: 793-503/000-005**

WMB marking card; as card; MARKED; 11 ... 20 (10x); not stretchable; Horizontal marking; snap-on type; red

www.wago.com/793-503/000-005**Item no.: 793-503/000-006**

WMB marking card; as card; MARKED; 11 ... 20 (10x); not stretchable; Horizontal marking; snap-on type; blue

www.wago.com/793-503/000-006**Item no.: 793-503/000-007**

WMB marking card; as card; MARKED; 11 ... 20 (10x); not stretchable; Horizontal marking; snap-on type; gray

www.wago.com/793-503/000-007**Item no.: 793-503/000-012**

WMB marking card; as card; MARKED; 11 ... 20 (10x); not stretchable; Horizontal marking; snap-on type; orange

www.wago.com/793-503/000-012**Item no.: 793-503/000-017**

WMB marking card; as card; MARKED; 11 ... 20 (10x); not stretchable; Horizontal marking; snap-on type; light green

www.wago.com/793-503/000-017**Item no.: 793-503/000-023**

WMB marking card; as card; MARKED; 11 ... 20 (10x); not stretchable; Horizontal marking; snap-on type; green

www.wago.com/793-503/000-023**Item no.: 793-503/000-024**

WMB marking card; as card; MARKED; 11 ... 20 (10x); not stretchable; Horizontal marking; snap-on type; violet

www.wago.com/793-503/000-024**Item no.: 793-504**

WMB marking card; as card; MARKED; 21 ... 30 (10x); not stretchable; Horizontal marking; snap-on type; white

www.wago.com/793-504**Item no.: 793-504/000-002**

WMB marking card; as card; MARKED; 21 ... 30 (10x); not stretchable; Horizontal marking; snap-on type; yellow

www.wago.com/793-504/000-002**Item no.: 793-504/000-005**

Subject to changes. Please also observe the further product documentation!

WAGO Kontakttechnik GmbH & Co. KG

Hansastr. 27

32423 Minden

Phone: +49571 887-0 | Fax: +49571 887-169

Email: info.de@wago.com | Web: www.wago.com

Do you have any questions about our products?

We are always happy to take your call at +49 (571) 887-44222.



WMB marking card; as card; MARKED; 21 ... 30 (10x); not stretchable; Horizontal marking; snap-on type; www.wago.com/793-504/000-005
red



Item no.: 793-504/000-006
WMB marking card; as card; MARKED; 21 ... 30 (10x); not stretchable; Horizontal marking; snap-on type; www.wago.com/793-504/000-006
blue



Item no.: 793-504/000-012
WMB marking card; as card; MARKED; 21 ... 30 (10x); not stretchable; Horizontal marking; snap-on type; www.wago.com/793-504/000-012
orange



Item no.: 793-504/000-017
WMB marking card; as card; MARKED; 21 ... 30 (10x); not stretchable; Horizontal marking; snap-on type; www.wago.com/793-504/000-017
light green



Item no.: 793-504/000-023
WMB marking card; as card; MARKED; 21 ... 30 (10x); not stretchable; Horizontal marking; snap-on type; www.wago.com/793-504/000-023
green



Item no.: 793-505
WMB marking card; as card; MARKED; 31 ... 40 (10x); not stretchable; Horizontal marking; snap-on type; www.wago.com/793-505
white



Item no.: 793-505/000-005
WMB marking card; as card; MARKED; 31 ... 40 (10x); not stretchable; Horizontal marking; snap-on type; www.wago.com/793-505/000-005
red



Item no.: 793-505/000-006
WMB marking card; as card; MARKED; 31 ... 40 (10x); not stretchable; Horizontal marking; snap-on type; www.wago.com/793-505/000-006
blue



Item no.: 793-505/000-007
WMB marking card; as card; MARKED; 31 ... 40 (10x); not stretchable; Horizontal marking; snap-on type; www.wago.com/793-505/000-007
gray



Item no.: 793-505/000-012
WMB marking card; as card; MARKED; 31 ... 40 (10x); not stretchable; Horizontal marking; snap-on type; www.wago.com/793-505/000-012
orange



Item no.: 793-506
WMB marking card; as card; MARKED; 41 ... 50 (10x); not stretchable; Horizontal marking; snap-on type; www.wago.com/793-506
white



Item no.: 793-506/000-005
WMB marking card; as card; MARKED; 41 ... 50 (10x); not stretchable; Horizontal marking; snap-on type; www.wago.com/793-506/000-005
red















Item no.: 793-506/000-006
WMB marking card; as card; MARKED; 41 ... 50 (10x); not stretchable; Horizontal marking; snap-on type; www.wago.com/793-506/000-006
blue



Item no.: 793-506/000-012
WMB marking card; as card; MARKED; 41 ... 50 (10x); not stretchable; Horizontal marking; snap-on type; www.wago.com/793-506/000-012
orange

Subject to changes. Please also observe the further product documentation!

| | | |
|--|---|--|
|  | <p>Item no.: 793-506/000-017 WMB marking card; as card; MARKED; 41 ... 50 (10x); not stretchable; Horizontal marking; snap-on type; light green</p> | www.wago.com/793-506/000-017 |
|  | <p>Item no.: 793-5501 WMB marking card; as card; for terminal block width 5 - 17.5 mm; stretchable 5 - 5.2 mm; plain; snap-on type; white</p> | www.wago.com/793-5501 |
|  | <p>Item no.: 793-5501/000-002 WMB marking card; as card; for terminal block width 5 - 17.5 mm; stretchable 5 - 5.2 mm; plain; snap-on type; yellow</p> | www.wago.com/793-5501/000-002 |
|  | <p>Item no.: 793-5501/000-005 WMB marking card; as card; for terminal block width 5 - 17.5 mm; stretchable 5 - 5.2 mm; plain; snap-on type; red</p> | www.wago.com/793-5501/000-005 |
|  | <p>Item no.: 793-5501/000-006 WMB marking card; as card; for terminal block width 5 - 17.5 mm; stretchable 5 - 5.2 mm; plain; snap-on type; blue</p> | www.wago.com/793-5501/000-006 |
|  | <p>Item no.: 793-5501/000-007 WMB marking card; as card; for terminal block width 5 - 17.5 mm; stretchable 5 - 5.2 mm; plain; snap-on type; gray</p> | www.wago.com/793-5501/000-007 |
|  | <p>Item no.: 793-5501/000-012 WMB marking card; as card; for terminal block width 5 - 17.5 mm; stretchable 5 - 5.2 mm; plain; snap-on type; orange</p> | www.wago.com/793-5501/000-012 |
|  | <p>Item no.: 793-5501/000-014 WMB marking card; as card; for terminal block width 5 - 17.5 mm; stretchable 5 - 5.2 mm; plain; snap-on type; brown</p> | www.wago.com/793-5501/000-014 |
|  | <p>Item no.: 793-5501/000-017 WMB marking card; as card; for terminal block width 5 - 17.5 mm; stretchable 5 - 5.2 mm; plain; snap-on type; green</p> | www.wago.com/793-5501/000-017 |
|  | <p>Item no.: 793-5501/000-023 WMB marking card; as card; for terminal block width 5 - 17.5 mm; stretchable 5 - 5.2 mm; plain; snap-on type; light green</p> | www.wago.com/793-5501/000-023 |
|  | <p>Item no.: 793-5501/000-024 WMB marking card; as card; for terminal block width 5 - 17.5 mm; stretchable 5 - 5.2 mm; plain; snap-on type; violet</p> | www.wago.com/793-5501/000-024 |
|  | <p>Item no.: 793-566 WMB marking card; as card; MARKED; 1 ... 50 (2x); not stretchable; Horizontal marking; snap-on type; white</p> | www.wago.com/793-566 |
|  | <p>Item no.: 793-566/000-002 WMB marking card; as card; MARKED; 1 ... 50 (2x); not stretchable; Horizontal marking; snap-on type; yellow</p> | www.wago.com/793-566/000-002 |
| | <p>Item no.: 793-566/000-005 WMB marking card; as card; MARKED; 1 ... 50 (2x); not stretchable; Horizontal marking; snap-on type;</p> | |

Subject to changes. Please also observe the further product documentation!



red

www.wago.com/793-566/000-005
**Item no.: 793-566/000-006**

WMB marking card; as card; MARKED; 1 ... 50 (2x); not stretchable; Horizontal marking; snap-on type; blue

www.wago.com/793-566/000-006
**Item no.: 793-566/000-007**

WMB marking card; as card; MARKED; 1 ... 50 (2x); not stretchable; Horizontal marking; snap-on type; gray

www.wago.com/793-566/000-007
**Item no.: 793-566/000-012**

WMB marking card; as card; MARKED; 1 ... 50 (2x); not stretchable; Horizontal marking; snap-on type; orange

www.wago.com/793-566/000-012
**Item no.: 793-566/000-017**

WMB marking card; as card; MARKED; 1 ... 50 (2x); not stretchable; Horizontal marking; snap-on type; light green

www.wago.com/793-566/000-017
**Item no.: 793-566/000-023**

WMB marking card; as card; MARKED; 1 ... 50 (2x); not stretchable; Horizontal marking; snap-on type; green

www.wago.com/793-566/000-023
**Item no.: 793-566/000-024**

WMB marking card; as card; MARKED; 1 ... 50 (2x); not stretchable; Horizontal marking; snap-on type; violet

www.wago.com/793-566/000-024

transfer module

**Item no.: 857-981**

Interface adapter; 14-pole; High-side switching input

www.wago.com/857-981
**Item no.: 857-982**

Interface adapter; 14-pole; High-side switching output

www.wago.com/857-982
**Item no.: 857-986**

Interface adapter; 15-pole; High-side switching input

www.wago.com/857-986

ferrule

**Item no.: 216-241**Ferrule; Sleeve for 0.5 mm² / 20 AWG; insulated; electro-tin plated; electrolytic copper; gastight crimped; acc. to DIN 46228, Part 4/09.90; white
www.wago.com/216-241
**Item no.: 216-242**Ferrule; Sleeve for 0.75 mm² / 18 AWG; insulated; electro-tin plated; electrolytic copper; gastight crimped; acc. to DIN 46228, Part 4/09.90; gray
www.wago.com/216-242
**Item no.: 216-243**Ferrule; Sleeve for 1 mm² / AWG 18; insulated; electro-tin plated; electrolytic copper; gastight crimped; acc. to DIN 46228, Part 4/09.90; red
www.wago.com/216-243
**Item no.: 216-244**Ferrule; Sleeve for 1.5 mm² / AWG 16; insulated; electro-tin plated; electrolytic copper; gastight crimped; acc. to DIN 46228, Part 4/09.90; black
www.wago.com/216-244

Subject to changes. Please also observe the further product documentation!

WAGO Kontakttechnik GmbH & Co. KG

Hansastr. 27

32423 Minden















Phone: +49571 887-0 | Fax: +49571 887-169

Email: info.de@wago.com | Web: www.wago.com















Do you have any questions about our products?

We are always happy to take your call at +49 (571) 887-44222.











Jumper

| | | |
|--|---|--|
|  | Item no.: 281-482 Comb-style jumper bar; insulated; 2-way; IN = IN terminal block; gray | www.wago.com/281-482 |
|  | Item no.: 859-402 Push-in type jumper bar; 2-way; Nominal current 18 A; insulated; light gray | www.wago.com/859-402 |
|  | Item no.: 859-402/000-005 Push-in type jumper bar; 2-way; Nominal current 18 A; insulated; red | www.wago.com/859-402/000-005 |
|  | Item no.: 859-402/000-006 Push-in type jumper bar; 2-way; Nominal current 18 A; insulated; blue | www.wago.com/859-402/000-006 |
|  | Item no.: 859-402/000-029 Push-in type jumper bar; 2-way; Nominal current 18 A; insulated; yellow | www.wago.com/859-402/000-029 |
|  | Item no.: 859-403 Push-in type jumper bar; 3-way; Nominal current 18 A; insulated; light gray | www.wago.com/859-403 |
|  | Item no.: 859-403/000-005 Push-in type jumper bar; 3-way; Nominal current 18 A; insulated; red | www.wago.com/859-403/000-005 |
|  | Item no.: 859-403/000-006 Push-in type jumper bar; 3-way; Nominal current 18 A; insulated; blue | www.wago.com/859-403/000-006 |
|  | Item no.: 859-403/000-029 Push-in type jumper bar; 3-way; Nominal current 18 A; insulated; yellow | www.wago.com/859-403/000-029 |
|  | Item no.: 859-404 Push-in type jumper bar; 4-way; Nominal current 18 A; insulated; light gray | www.wago.com/859-404 |
|  | Item no.: 859-404/000-005 Push-in type jumper bar; 4-way; Nominal current 18 A; insulated; red | www.wago.com/859-404/000-005 |
|  | Item no.: 859-404/000-006 Push-in type jumper bar; 4-way; Nominal current 18 A; insulated; blue | www.wago.com/859-404/000-006 |
|  | Item no.: 859-404/000-029 Push-in type jumper bar; 4-way; Nominal current 18 A; insulated; yellow | www.wago.com/859-404/000-029 |
|  | Item no.: 859-405 Push-in type jumper bar; 5-way; Nominal current 18 A; insulated; light gray | www.wago.com/859-405 |

Subject to changes. Please also observe the further product documentation!

| | | |
|--|---|--|
|  | Item no.: 859-405/000-005 Push-in type jumper bar; 5-way; Nominal current 18 A; insulated; red | www.wago.com/859-405/000-005 |
|  | Item no.: 859-405/000-006 Push-in type jumper bar; 5-way; Nominal current 18 A; insulated; blue | www.wago.com/859-405/000-006 |
|  | Item no.: 859-405/000-029 Push-in type jumper bar; 5-way; Nominal current 18 A; insulated; yellow | www.wago.com/859-405/000-029 |
|  | Item no.: 859-406 Push-in type jumper bar; 6-way; Nominal current 18 A; insulated; light gray | www.wago.com/859-406 |
|  | Item no.: 859-406/000-005 Push-in type jumper bar; 6-way; Nominal current 18 A; insulated; red | www.wago.com/859-406/000-005 |
|  | Item no.: 859-406/000-006 Push-in type jumper bar; 6-way; Nominal current 18 A; insulated; blue | www.wago.com/859-406/000-006 |
|  | Item no.: 859-406/000-029 Push-in type jumper bar; 6-way; Nominal current 18 A; insulated; yellow | www.wago.com/859-406/000-029 |
|  | Item no.: 859-407 Push-in type jumper bar; 7-way; Nominal current 18 A; insulated; light gray | www.wago.com/859-407 |
|  | Item no.: 859-407/000-005 Push-in type jumper bar; 7-way; Nominal current 18 A; insulated; red | www.wago.com/859-407/000-005 |
|  | Item no.: 859-407/000-006 Push-in type jumper bar; 7-way; Nominal current 18 A; insulated; blue | www.wago.com/859-407/000-006 |
|  | Item no.: 859-407/000-029 Push-in type jumper bar; 7-way; Nominal current 18 A; insulated; yellow | www.wago.com/859-407/000-029 |
|  | Item no.: 859-408 Push-in type jumper bar; 8-way; Nominal current 18 A; insulated; light gray | www.wago.com/859-408 |
|  | Item no.: 859-408/000-005 Push-in type jumper bar; 8-way; Nominal current 18 A; insulated; red | www.wago.com/859-408/000-005 |
|  | Item no.: 859-408/000-006 Push-in type jumper bar; 8-way; Nominal current 18 A; insulated; blue | www.wago.com/859-408/000-006 |

Subject to changes. Please also observe the further product documentation!

| | | |
|--|--|--|
|  | Item no.: 859-408/000-029 Push-in type jumper bar; 8-way; Nominal current 18 A; insulated; yellow | www.wago.com/859-408/000-029 |
|  | Item no.: 859-409 Push-in type jumper bar; 9-way; Nominal current 18 A; insulated; light gray | www.wago.com/859-409 |
|  | Item no.: 859-409/000-005 Push-in type jumper bar; 9-way; Nominal current 18 A; insulated; red | www.wago.com/859-409/000-005 |
|  | Item no.: 859-409/000-006 Push-in type jumper bar; 9-way; Nominal current 18 A; insulated; blue | www.wago.com/859-409/000-006 |
|  | Item no.: 859-409/000-029 Push-in type jumper bar; 9-way; Nominal current 18 A; insulated; yellow | www.wago.com/859-409/000-029 |
|  | Item no.: 859-410 Push-in type jumper bar; 10-way; Nominal current 18 A; insulated; light gray | www.wago.com/859-410 |
|  | Item no.: 859-410/000-005 Push-in type jumper bar; 10-way; Nominal current 18 A; insulated; red | www.wago.com/859-410/000-005 |
|  | Item no.: 859-410/000-006 Push-in type jumper bar; 10-way; Nominal current 18 A; insulated; blue | www.wago.com/859-410/000-006 |
|  | Item no.: 859-410/000-029 Push-in type jumper bar; 10-way; Nominal current 18 A; insulated; yellow | www.wago.com/859-410/000-029 |
| tools | | |
|  | Item no.: 210-720 Operating tool; Blade: 3.5 x 0.5 mm; with a partially insulated shaft | www.wago.com/210-720 |

Downloads Documentation

Bid Text

| | | | |
|------------------------------|--------------|-----------------|----------|
| 857-724 GAEB docx - Datei | Feb 20, 2019 | docx 16.5 kB | Download |
| 857-724 GAEB X81 - Datei | Feb 19, 2019 | xml 4.2 kB | Download |

Instruction Leaflet

Subject to changes. Please also observe the further product documentation!

| | | | |
|--|--|---------------|----------|
| Stecksockel mit Optokoppler Eingangsnennspannung DC 24 V, Schaltstrom 2 A | | pdf 2.4 MB | Download |
|--|--|---------------|----------|

| | | | |
|---|-------------------------|---------------|----------|
| Elektromechanical and Solid-State Relays/Optocouplers | V 1.4.0 Oct 15, 2019 | pdf 2.4 MB | Download |
|---|-------------------------|---------------|----------|

Additional Information

| | | | |
|--|---------|-----------------|----------|
| Disposal; Electrical and electronic equipment, Packaging | V 1.0.0 | pdf 265.8 kB | Download |
|--|---------|-----------------|----------|

| | | | |
|---------------------------|---------------------|-----------------|----------|
| Step Datei Serie 857-07xx | 1.0 Jun 20, 2011 | ifc 299.3 kB | Download |
|---------------------------|---------------------|-----------------|----------|

CAD/CAE-Data

CAD data

| | | | |
|----------------------|--|-----|----------|
| 2D/3D Models 857-724 | | URL | Download |
|----------------------|--|-----|----------|

CAE data

| | | | |
|---------------------------|--|-----|----------|
| EPLAN Data Portal 857-724 | | URL | Download |
|---------------------------|--|-----|----------|

| | | | |
|------------------------|--|-----|----------|
| WSCAD Universe 857-724 | | URL | Download |
|------------------------|--|-----|----------|

Handling Instructions

Conductor termination

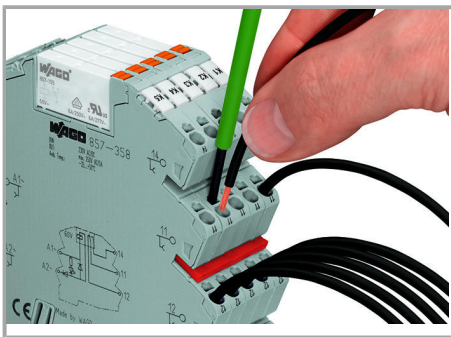

Connection of conductor

Commoning

Subject to changes. Please also observe the further product documentation!

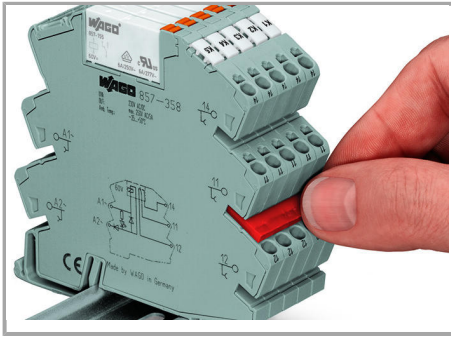

Easy commoning using adjacent jumpers

Marking

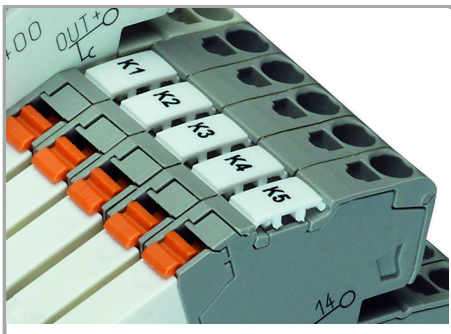

Marking using WMB Multi markers

Installation

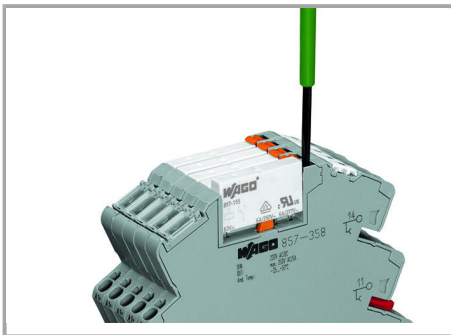

Operation of the relay ejector

Subject to changes. Please also observe the further product documentation!