

TECHNICAL CHARACTERISTICS

MATERIAL
 INSULATOR: LCP
 FLAMMABILITY RATING: UL94-V0
 COLOR: BEIGE
 CONTACT MATERIAL: PHOSPHOR BRONZE
 CONTACT TYPE: STAMPED
 CONTACT PLATING: TIN
 QUALITY CLASS: 25 MATING CYCLES
 PITCH: 1.00 MM

ENVIRONMENTAL
 OPERATING TEMPERATURE: -25 UP TO 85°C
 COMPLIANCE: LEAD FREE AND ROHS

ELECTRICAL
 CURRENT RATING: 1 A
 WORKING VOLTAGE: 50 VAC
 INSULATOR RESISTANCE: >100 MΩ
 DIELECTRIC WITHSTANDING VOLTAGE: 500 VAC/MN
 CONTACT RESISTANCE: 20 mΩ MAX

STANDARD
 CERTIFIED: E323964

SOLDERING
 JEDEC LEAD FREE REFLOW SOLDERING PROCESS

PACKAGING
 TAPE & REEL WITH CAP

DIMENSION
 A = NB. PIN -1
 B = NB. PIN +2
 C = NB. PIN +0.6

RoHS Compliant			
E	28-FEB-17	TPK	AK
D	25-OCT-16	PCN	AK
C	04-AUG-15	UPDATE	AK
B	14-OCT-14	TPK DWG UPDATE	QL
A	16-JUL-14	PDF	AS
REV	DATE	FILE	BY

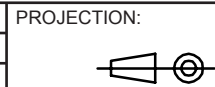

APPROVAL: BBu

GENERAL TOLERANCE
 .X = +/- 0.30
 .XX = +/- 0.20

UNIT: MM
 SCALE:
 SHEET: 1/3
 DRAW: AK



DESCRIPTION: WR-WTB 1.00 MM SMT MALE VERTICAL SHROUDED HEADER
 WERI PART NO: 665 3xx 124 022

SIZE
A4

1

2

3

4

5

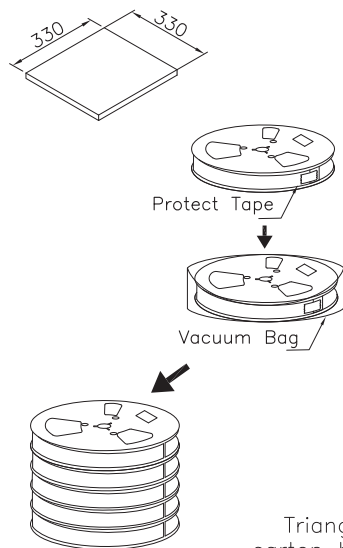
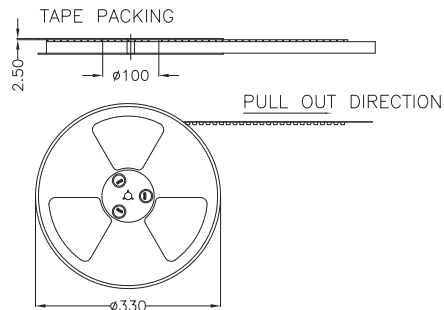

Note:
 1.All dimensions meet EIA-481-3 requirements.
 2.Material: BK Conductive Polystyrene Alloy
 100% recyclable.
 3.Thickness : 0.40±0.05mm
 4.Component load per 13" reel :1000 pcs.
 5.CARTON SIZE:350*350*296(mm)
 Vacuum bag:450*500*0.2(mm)

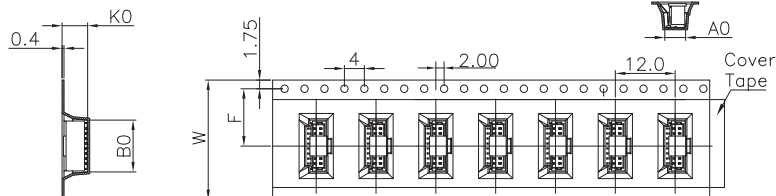

For Reel width (dimension W)16,24mm
 Single row hole

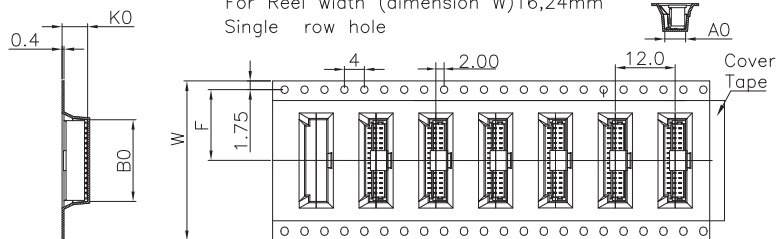

For Reel width (dimension W)32,44,56,72mm
 Double rows hole

Pin	W	F	A0	B0	K0	PCS/R	R/CTN	Q'TY	Pin	W	F	A0	B0	K0	PCS/R	R/CTN	Q'TY
02	16	7.5	4.2	4.4	5.15	1000	12	12000	10	24	11.5	4.2	12.4	5.15	1000	9	9000
03	16	7.5	4.2	5.4	5.15	1000	12	12000	11	24	11.5	4.2	13.4	5.15	1000	9	9000
04	16	7.5	4.2	6.4	5.15	1000	12	12000	12	24	11.5	4.2	14.4	5.15	1000	9	9000
05	16	7.5	4.2	7.4	5.15	1000	12	12000	13	24	11.5	4.2	15.4	5.15	1000	9	9000
06	16	7.5	4.2	8.4	5.15	1000	12	12000	14	32	14.2	4.2	16.4	5.15	1000	7	7000
07	24	11.5	4.2	9.4	5.15	1000	9	9000	15	32	14.2	4.2	17.4	5.15	1000	7	7000
08	24	11.5	4.2	10.4	5.15	1000	9	9000	16	32	14.2	4.2	18.4	5.15	1000	7	7000
09	24	11.5	4.2	11.4	5.15	1000	9	9000	20	44	20.2	4.2	22.4	5.15	1000	5	5000

RoHS Compliant

G				
F				
E				
D				
C				
B				
A				
REV	DATE	FILE	BY	

PROJECTION:

APPROVAL: BBu

GENERAL TOLERANCE

.X = +/- 0.2

.XX = +/- 0.15

UNIT: MM

SCALE:

SHEET: 2/3

DRAW: AS

DESCRIPTION: WR-WTB 1.00 MM SMT MALE VERTICAL SHROUDED HEADER

WERI PART NO: 665 3xx 124 022

SIZE
A4

A

B

C

D

1

2

3

4

5

Cautions and Warnings:

This electronic component is designed and developed with the intention for use in general electronics equipments.

Before incorporating the components into any equipments in the field such as aerospace, aviation, nuclear control, submarine, transportation, (automotive control, train control, ship control), transportation signal, disaster prevention, medical, public information network etc. where higher safety and reliability are especially required or if there is possibility of direct damage or injury to human body, Würth Elektronik must be asked for a written approval.



In addition, even electronic component in general electronic equipments, when used in electrical circuits that require high safety, reliability functions or performance, the sufficient reliability evaluation-check for the safety must be performed before by the user before usage.

A

B

C

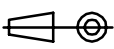
RoHS Compliant

G				PROJECTION: 	GENERAL TOLERANCE .X = +/- 0.2 .XX = +/- 0.15		
F							
E							
D							
C				APPROVAL: JC	UNIT: MM	DESCRIPTION: DISCLAIMER	SIZE A4
B					SCALE:		
A	10-SEP-14	PDF	QL		SHEET: 3/3	WERI PART NO: DISCLAIMER	
REV	DATE	FILE	BY		DRAW: QL		

D

Mouser Electronics

Authorized Distributor

Click to View Pricing, Inventory, Delivery & Lifecycle Information:

[Wurth Elektronik:](#)

[665310124022](#)