

**DATA SHEET**

# SKY67153-396LF: 0.7 to 3.8 GHz Ultra Low-Noise Amplifier

## Applications

- LTE, GSM, WCDMA, HSDPA macro and micro base stations
- L and S band ultra low-noise receivers
- Cellular repeaters, DAS and RRH/RRUs
- High temperature transceiver applications to +105 °C

## Features

- Ultra-low Evaluation Board NF:
  - 0.25 dB @ 849 MHz
  - 0.35 dB @ 1850 MHz
  - 0.50 dB @ 2500 MHz
  - 0.70 dB @ 3600 MHz
- High OIP3 performance: >+34 dBm over 700 to 3800 MHz
- Adjustable supply current from 30 to 100 mA
- Flexible bias voltage: 3 to 5 V
- Temperature and process-stable active bias
- Miniature DFN (8-pin, 2 x 2 mm) package (MSL1 @ 260 °C per JEDEC J-STD-020)



Skyworks Green™ products are compliant with all applicable legislation and are halogen-free. For additional information, refer to *Skyworks Definition of Green™*, document number SQ04-0074.

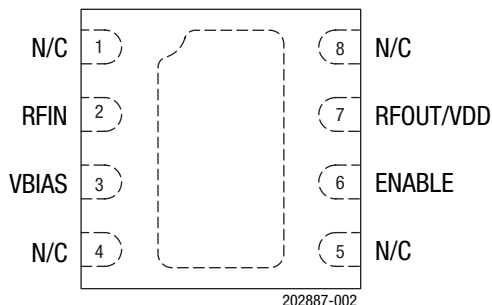

**Figure 2. SKY67153-396LF Pinout (Top View)**

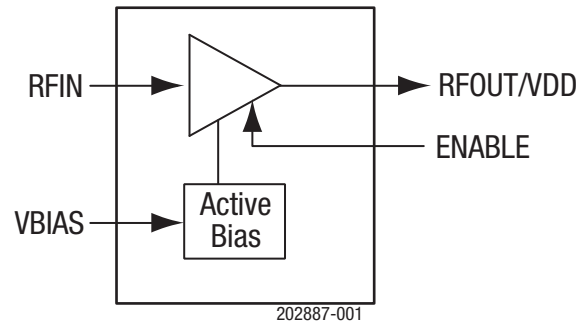

**Figure 1. SKY67153-396LF Block Diagram**

## Description

The SKY67153-396LF is GaAs, pHEMT low-noise amplifier (LNA) with an active bias, high linearity, superior gain, and industry-leading noise figure (NF) performance from 700 to 3800 MHz. The device features Skyworks advanced, pHEMT enhancement mode process in a compact 2 x 2 mm, 8-pin Dual Flat No-Lead (DFN) package.

The internal active bias circuitry provides stable performance over temperature and process variation. The device offers the ability to externally adjust supply current. Supply voltage is applied to the RFOUT/VDD pin through an RF choke inductor. The RFIN and RFOUT/VDD pins should be DC blocked to ensure proper operation.

The SKY67153-396LF operates in the frequency range of 0.7 to 3.8 GHz using a common layout and band-specific tunes.

A functional block diagram is shown in Figure 1. The pin configuration and package are shown in Figure 2. Signal pin assignments and functional pin descriptions are provided in Table 1.

**Table 1. SKY67153-396LF Signal Descriptions**

Pin	Name	Description	Pin	Name	Description
1	N/C	No connection. May be connected to ground with no change in performance.	5	N/C	No connection. May be connected to ground with no change in performance.
2	RFIN	RF input. DC blocking capacitor required.	6	ENABLE	Enable pin. Active low = amplifier “on” state
3	VBIAS	Bias voltage for input gate. External resistor sets current consumption.	7	RFOUT/VDD	RF output. Apply VDD through RF choke inductor. DC blocking capacitor required.
4	N/C	No connection. May be connected to ground with no change in performance.	8	N/C	No connection. May be connected to ground with no change in performance.

### Electrical and Mechanical Specifications

The absolute maximum ratings of the SKY67153-396LF are provided in Table 2. Electrical specifications are provided in Tables 3 through 8.

Typical performance characteristics are illustrated in Figures 3 through 22.

**Table 2. SKY67153-396LF Absolute Maximum Ratings<sup>1</sup>**

Parameter	Symbol	Minimum	Maximum	Units
Supply voltage	V <sub>DD</sub>		5.5	V
Quiescent supply current	I <sub>DQ</sub>		120	mA
RF input power	P <sub>IN</sub>		+21	dBm
Storage temperature	T <sub>STG</sub>	-40	+150	°C
Operating temperature	T <sub>A</sub>	-40	+105	°C
Junction temperature	T <sub>J</sub>		+150	°C
Electrostatic discharge:	ESD			
Charged Device Model (CDM), Class 4			1000	V
Human Body Model (HBM), Class 1A			250	V
Machine Model (MM), Class A			30	V

<sup>1</sup> Exposure to maximum rating conditions for extended periods may reduce device reliability. There is no damage to device with only one parameter set at the limit and all other parameters set at or below their nominal value. Exceeding any of the limits listed here may result in permanent damage to the device.

**ESD HANDLING:** *Although this device is designed to be as robust as possible, electrostatic discharge (ESD) can damage this device. This device must be protected at all times from ESD when handling or transporting. Static charges may easily produce potentials of several kilovolts on the human body or equipment, which can discharge without detection. Industry-standard ESD handling precautions should be used at all times.*

**Table 3. SKY67153-396LF Electrical Specifications: Thermal Data<sup>1</sup>**

(V<sub>DD</sub> = 5 V, T<sub>A</sub> = +25 °C, P<sub>IN</sub> = -25 dBm, Characteristic Impedance [Z<sub>0</sub>] = 50 Ω, Unless Otherwise Noted)

Parameter	Symbol	Test Condition	Min	Typ	Max	Units
Thermal resistance	Θ <sub>JC</sub>			45		°C/W
Channel temperature @ +85 °C reference (package heat slug)		V <sub>DD</sub> = 5 V, I <sub>DQ</sub> = 70 mA, no RF applied, dissipated power = 0.35 W		101		°C

<sup>1</sup> Performance is guaranteed only under the conditions listed in this table.

**Table 4. SKY67153-396LF Electrical Specifications: 2300 to 2700 MHz Optimized Tuning<sup>1</sup>**

(V<sub>DD</sub> = 5 V, T<sub>A</sub> = +25 °C, P<sub>IN</sub> = -20 dBm, Characteristic Impedance [Z<sub>0</sub>] = 50 Ω, Unless Otherwise Noted)

Parameter	Symbol	Test Condition	Min	Typ	Max	Units
<b>RF Specifications</b>						
Noise figure	NF	@ 2500 MHz, includes Evaluation Board loss		0.50	0.65	dB
Small signal gain	IS21I	@ 2500 MHz	17.5	19.0		dB
Input return loss	IS11I	@ 2500 MHz		11		dB
Output return loss	IS22I	@ 2500 MHz		20		dB
Reverse isolation	IS12I	@ 2500 MHz		28		dB
Third order input intercept point	IIP3	@ 2500 MHz, Δf = 1 MHz, P <sub>IN</sub> = -20 dBm/tone	+14	+17		dBm
Third order output intercept point	OIP3	@ 2500 MHz, Δf = 1 MHz, P <sub>IN</sub> = -20 dBm/tone	+33	+36		dBm
1 dB input compression point	IP1dB	@ 2500 MHz	0	+2		dBm
1 dB output compression point	OP1dB	@ 2500 MHz	+18	+20		dBm
<b>DC Specifications</b>						
Supply voltage	V <sub>DD</sub>			5		V
Quiescent supply current	I <sub>DQ</sub>	Set with external resistor	58	72	86	mA
Bias current	I <sub>BIAS</sub>			500		μA
Enable voltage:	V <sub>ENABLE</sub>					
Gain mode			0		0.2	V
Power-down mode			1.5		5.5	V
Enable rise time (Note 2)	T <sub>R</sub>	@ 2500 MHz		250	500	ns
Enable fall time (Note 2)	T <sub>F</sub>	@ 2500 MHz		250	500	ns

<sup>1</sup> Performance is guaranteed only under the conditions listed in this table.

<sup>2</sup> Tested with a 100 kHz square wave, 1000 pF capacitance-to-ground on the ENABLE pin. Switching time can be improved by reducing the value of, or eliminating, the 1000 pF capacitor on pin 6 (component M17 in Figure 25).

### Typical Performance Characteristics, 2300 to 2700 MHz

(VDD = 5 V, TA = +25 °C, PIN = -20 dBm, Characteristic Impedance [Zo] = 50 Ω, Unless Otherwise Noted)

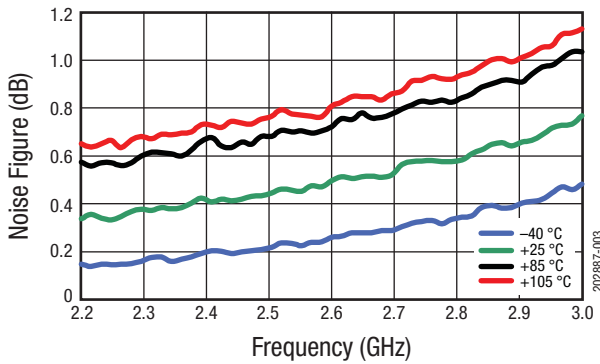

Figure 3. Evaluation board NF vs Frequency over Temperature

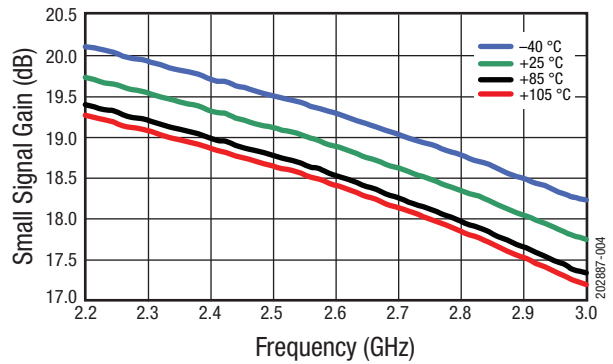

Figure 4. Narrow Band Gain vs Frequency over Temperature

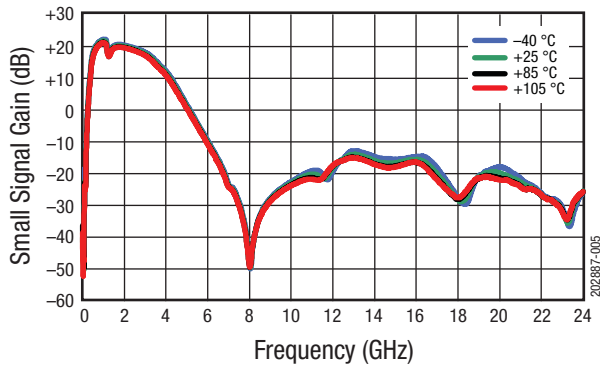

Figure 5. Broadband Gain vs Frequency over Temperature

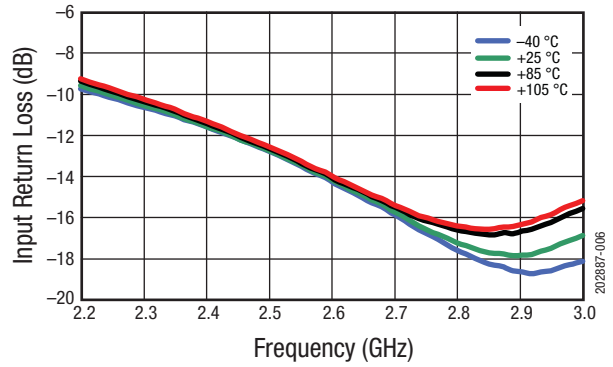

Figure 6. Narrowband Input Return Loss vs Frequency over Temperature

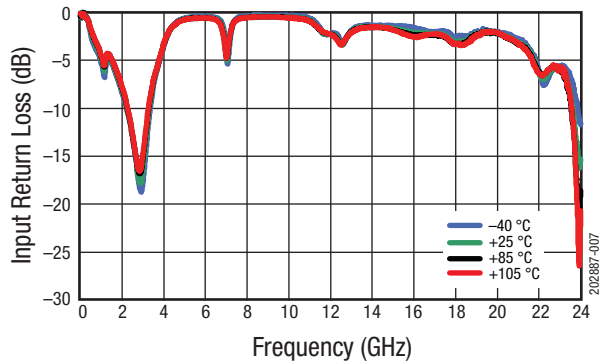

Figure 7. Broadband Input Return Loss vs Frequency over Temperature

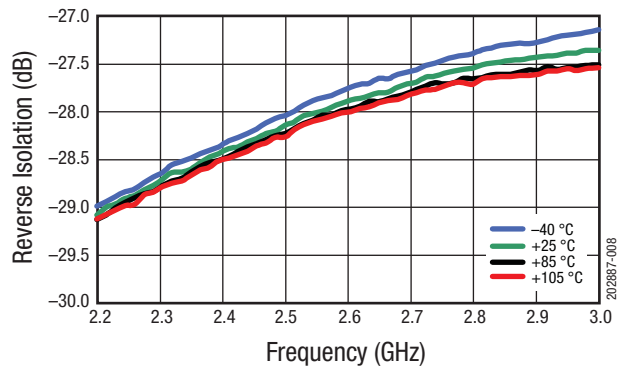

Figure 8. Narrowband Reverse Isolation vs Frequency over Temperature

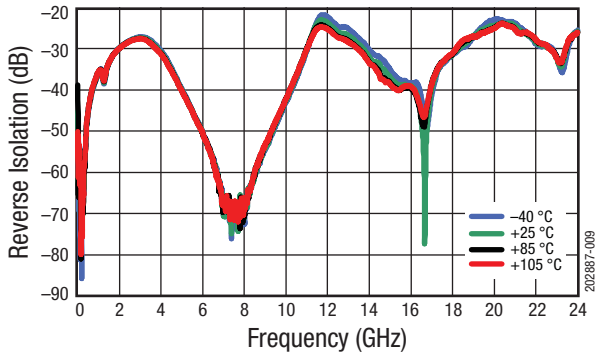

Figure 9. Broadband Reverse Isolation vs Frequency over Temperature

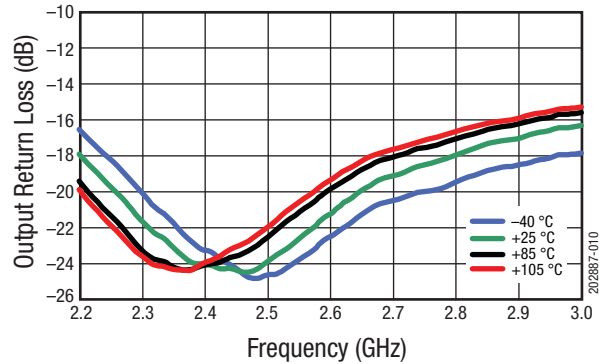

Figure 10. Narrowband Output Return Loss vs Frequency over Temperature

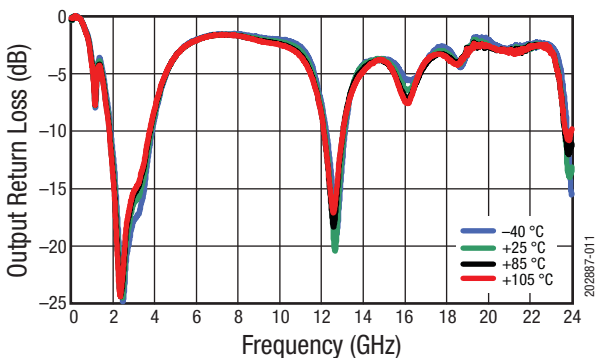

Figure 11. Broadband Output Return Loss vs Frequency over Temperature

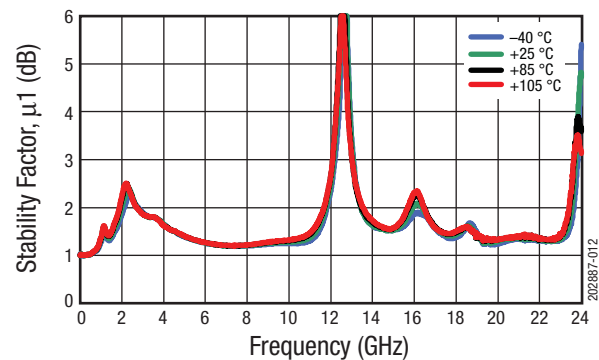

Figure 12. Stability Factor ( $\mu_1$ ) vs Frequency over Temperature

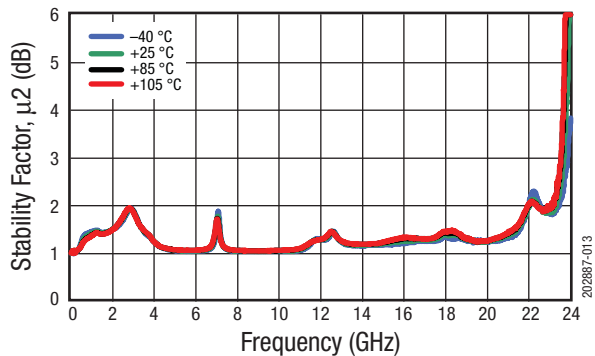

Figure 13. Stability Factor ( $\mu_2$ ) vs Frequency over Temperature

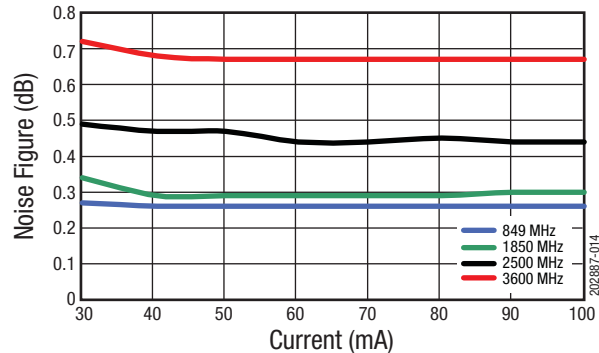

Figure 14. Evaluation Board NF vs Quiescent Current over Frequency Using Band-Specific BOM

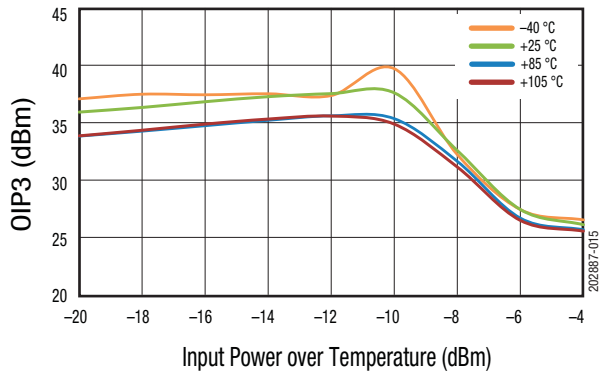

Figure 15. OIP3 vs Input Power over Temperature (@2500 MHz, 1MHz Spacing)

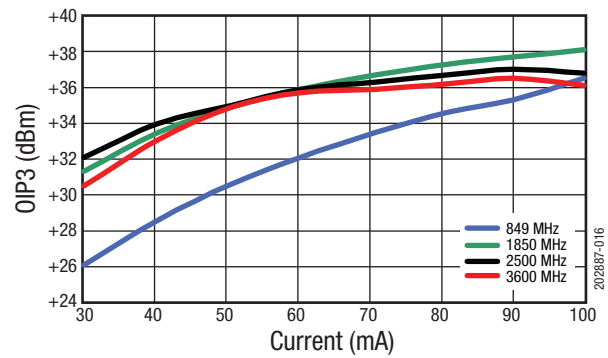

Figure 16. OIP3 vs Quiescent Current over Frequency Using Band-Specific BOM

Table 5. SKY67153-396LF Electrical Specifications: 700 to 1000 MHz Optimized Tuning<sup>1</sup>  
(V<sub>DD</sub> = 5 V, T<sub>A</sub> = +25 °C, P<sub>IN</sub> = -25 dBm, Characteristic Impedance [Z<sub>0</sub>] = 50 Ω, Unless Otherwise Noted)

Parameter	Symbol	Test Condition	Min	Typical	Max	Units
<b>RF Specifications</b>						
Noise figure	NF	@ 849 MHz, includes Evaluation Board loss		0.25	0.40	dB
Small signal gain	IS21I	@ 849 MHz	24.5	26.0		dB
Input return loss	IS11I	@ 849 MHz		12		dB
Output return loss	IS22I	@ 849 MHz		18		dB
Reverse isolation	IS12I	@ 849 MHz		33		dB
Third order input intercept point	IIP3	@ 849 MHz, Δf = 1 MHz, P <sub>IN</sub> = -25 dBm/tone	+5.5	+8.5		dBm
Third order output intercept point	OIP3	@ 849 MHz, Δf = 1 MHz, P <sub>IN</sub> = -25 dBm/tone	+31.5	+34.5		dBm
1 dB input compression point	IP1dB	@ 849 MHz	-5.5	-3.5		dBm
1 dB output compression point	OP1dB	@ 849 MHz	+19.5	+21.5		dBm
<b>DC Specifications</b>						
Supply voltage	V <sub>DD</sub>			5		V
Quiescent supply current	I <sub>DQ</sub>	Set with external resistor		80		mA
Bias current	I <sub>BIAS</sub>			500		μA
Enable voltage: Gain mode	V <sub>ENABLE</sub>		0		0.2	V
Power-down mode			1.5		5.5	V
Enable rise time <sup>2</sup>	T <sub>R</sub>	@ 849 MHz		250	500	ns
Enable fall time <sup>2</sup>	T <sub>F</sub>	@ 849 MHz		250	500	ns

<sup>1</sup> Performance is guaranteed only under the conditions listed in this table.

<sup>2</sup> Tested with a 100 kHz square wave, 1000 pF capacitance-to-ground on the ENABLE pin. Switching time can be improved by reducing the value of, or eliminating, the 1000 pF capacitor on pin 6 (component M17 in Figure 25).

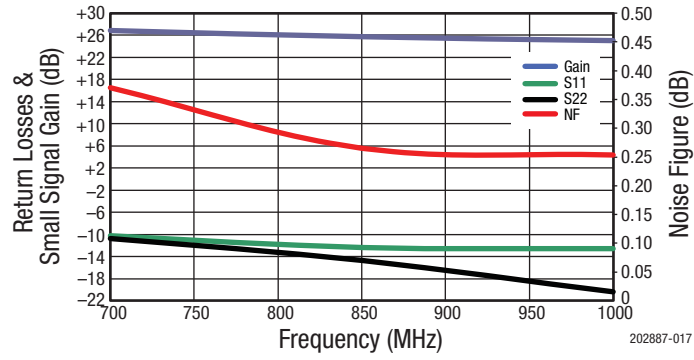

Figure 17. Evaluation Board NF, Gain, and Return Losses for 700 to 1000 MHz Tuning

**Table 6. SKY67153-396LF Electrical Specifications: 1600 to 2170 MHz Optimized Tuning (Note 1)**  
 (V<sub>DD</sub> = 5 V, T<sub>A</sub> = +25 °C, P<sub>IN</sub> = -20 dBm, Characteristic Impedance [Z<sub>0</sub>] = 50 Ω, Unless Otherwise Noted)

Parameter	Symbol	Test Condition	Min	Typical	Max	Units
<b>RF Specifications</b>						
Noise figure	NF	@ 1850 MHz, includes Evaluation Board loss		0.35	0.50	dB
Small signal gain	IS21I	@ 1850 MHz	19.0	20.5		dB
Input return loss	IS11I	@ 1850 MHz		12		dB
Output return loss	IS22I	@ 1850 MHz		16		dB
Reverse isolation	IS12I	@ 1850 MHz		29		dB
Third order input intercept point	IIP3	@ 1850 MHz, Δf = 1 MHz, P <sub>IN</sub> = -20 dBm/tone	+12.5	+15.5		dBm
Third order output intercept point	OIP3	@ 1850 MHz, Δf = 1 MHz, P <sub>IN</sub> = -20 dBm/tone	+33	+36		dBm
1 dB input compression point	IP1dB	@ 1850 MHz	-1	+1		dBm
1 dB output compression point	OP1dB	@ 1850 MHz	+18.5	+20.5		dBm
<b>DC Specifications</b>						
Supply voltage	V <sub>DD</sub>			5		V
Quiescent supply current	I <sub>DQ</sub>	Set with external resistor		70		mA
Bias current	I <sub>BIAS</sub>			500		μA
Enable voltage: Gain mode	V <sub>ENABLE</sub>		0		0.2	V
Power-down mode			1.5		5.5	V
Enable rise time (Note 2)	T <sub>R</sub>	@ 1850 MHz		250	500	ns
Enable fall time (Note 2)	T <sub>F</sub>	@ 1850 MHz		250	500	ns

<sup>1</sup> Performance is guaranteed only under the conditions listed in this table.

<sup>2</sup> Tested with a 100 kHz square wave, 1000 pF capacitance-to-ground on the ENABLE pin. Switching time can be improved by reducing the value of, or eliminating, the 1000 pF capacitor on pin 6 (component M17 in Figure 25).

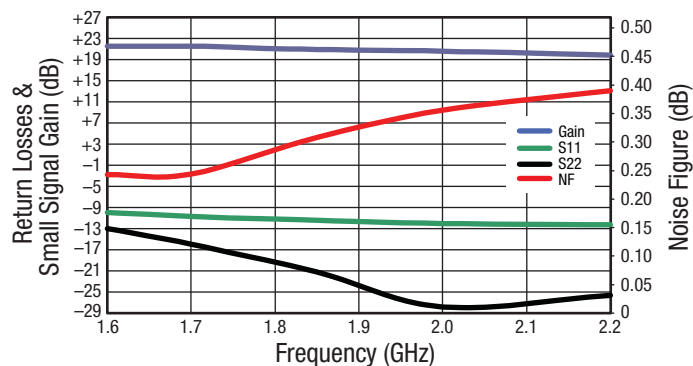

**Figure 18. Evaluation Board NF, Gain, and Return Losses for 1.6 to 2.2 GHz Tuning**

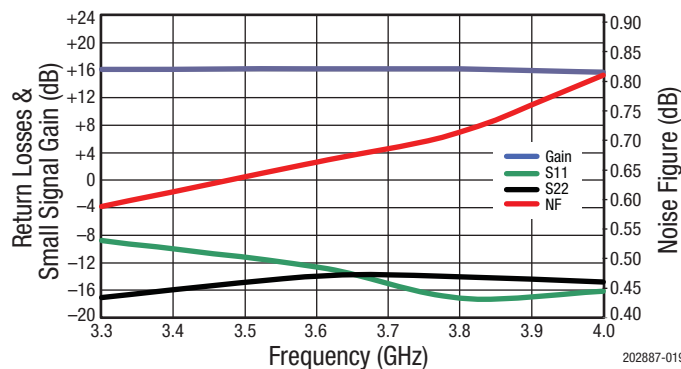

**Table 7. SKY67153-396LF Electrical Specifications: 3400 to 3800 MHz Optimized Tuning (Note 1)**  
**(V<sub>DD</sub> = 5 V, T<sub>A</sub> = +25 °C, P<sub>IN</sub> = -20 dBm, Characteristic Impedance [Z<sub>0</sub>] = 50 Ω, Unless Otherwise Noted)**

Parameter	Symbol	Test Condition	Min	Typ	Max	Units
<b>RF Specifications</b>						
Noise figure	NF	@ 3600 MHz, includes Evaluation Board loss		0.70	0.90	dB
Small signal gain	IS21I	@ 3600 MHz	14.5	16.5		dB
Input return loss	IS11I	@ 3600 MHz		10		dB
Output return loss	IS22I	@ 3600 MHz		16		dB
Reverse isolation	IS12I	@ 3600 MHz		28		dB
Third order input intercept point	IIP3	@ 3600 MHz, Δf = 1 MHz, P <sub>IN</sub> = -20 dBm/tone	+16.5	+19.5		dBm
Third order output intercept point	OIP3	@ 3600 MHz, Δf = 1 MHz, P <sub>IN</sub> = -20 dBm/tone	+33	+36		dBm
1 dB input compression point	IP1dB	@ 3600 MHz	+0.5	+2.5		dBm
1 dB output compression point	OP1dB	@ 3600 MHz	+16	+18		dBm
<b>DC Specifications</b>						
Supply voltage	V <sub>DD</sub>			5		V
Quiescent supply current	I <sub>DQ</sub>	Set with external resistor		80		mA
Bias current	I <sub>BIAS</sub>			500		μA
Enable voltage: Gain mode	V <sub>ENABLE</sub>		0		0.2	V
Power-down mode			1.5		5.5	V
Enable rise time <sup>2</sup>	T <sub>R</sub>	@ 3600 MHz		250	500	ns
Enable fall time <sup>2</sup>	T <sub>F</sub>	@ 3600 MHz		250	500	ns

<sup>1</sup> Performance is guaranteed only under the conditions listed in this table.

<sup>2</sup> Tested with a 100 kHz square wave, 1000 pF capacitance-to-ground on the ENABLE pin. Switching time can be improved by reducing the value of, or eliminating, the 1000 pF capacitor on pin 6 (component M17 in Figure 25).



**Figure 19. Evaluation Board NF, Gain, and Return Losses for 3.3 to 4.0 GHz Tuning**

**Table 8. Noise Parameters vs Frequency (@ +25 °C, 5 V, 70 mA) (1 of 3)**

Frequency (MHz)	F <sub>MIN</sub> (dB)	Gamma opt (Mag)	Gamma opt (Phase)	Noise Resistance (R <sub>N</sub> ) (Ω)	Associated Gain (dB)	Maximum Gain (G <sub>MAX</sub> ) (dB)
400	0.33	0.40	7.69	0.06	29.58	31.69
450	0.31	0.37	13.49	0.06	29.19	31.12
500	0.30	0.35	19.08	0.05	28.81	30.58
550	0.29	0.33	24.47	0.05	28.44	30.05
600	0.28	0.31	29.66	0.05	28.07	29.55
650	0.27	0.29	34.66	0.05	27.72	29.06
700	0.26	0.27	39.48	0.05	27.38	28.60
750	0.25	0.26	44.13	0.04	27.04	28.16
800	0.25	0.25	48.60	0.04	26.72	27.73
850	0.24	0.23	52.92	0.04	26.40	27.32
900	0.24	0.22	57.08	0.04	26.09	26.93
950	0.23	0.21	61.09	0.04	25.79	26.55
1000	0.23	0.20	64.96	0.04	25.50	26.19
1050	0.23	0.20	68.69	0.04	25.22	25.84
1100	0.23	0.19	72.29	0.03	24.94	25.51
1150	0.23	0.19	75.77	0.03	24.67	25.19
1200	0.23	0.18	79.12	0.03	24.41	24.89
1250	0.23	0.18	82.37	0.03	24.16	24.60
1300	0.24	0.18	85.51	0.03	23.91	24.32
1350	0.24	0.17	88.54	0.03	23.67	24.05
1400	0.24	0.17	91.48	0.03	23.43	23.79
1450	0.25	0.17	94.33	0.03	23.21	23.55
1500	0.25	0.17	97.09	0.03	22.98	23.31
1550	0.25	0.17	99.76	0.03	22.77	23.08
1600	0.26	0.18	102.36	0.03	22.56	22.87
1650	0.27	0.18	104.89	0.03	22.35	22.66
1700	0.27	0.18	107.35	0.03	22.15	22.46
1750	0.28	0.19	109.74	0.03	21.96	22.27
1800	0.28	0.19	112.08	0.03	21.77	22.08
1850	0.29	0.19	114.36	0.03	21.59	21.90
1900	0.30	0.20	116.58	0.03	21.41	21.73
1950	0.31	0.20	118.76	0.03	21.23	21.57
2000	0.31	0.21	120.89	0.03	21.06	21.41
2050	0.32	0.22	122.99	0.03	20.90	21.26
2100	0.33	0.22	125.04	0.03	20.74	21.11
2150	0.34	0.23	127.06	0.03	20.58	20.97
2200	0.35	0.24	129.05	0.03	20.42	20.83
2250	0.36	0.24	131.00	0.03	20.27	20.69

**Table 8. Noise Parameters vs Frequency (@ +25 °C, 5 V, 70 mA) (2 of 3)**

Frequency (MHz)	F <sub>MIN</sub> (dB)	Gamma opt (Mag)	Gamma opt (Phase)	Noise Resistance (R <sub>N</sub> ) (Ω)	Associated Gain (dB)	Maximum Gain (G <sub>MAX</sub> ) (dB)
2300	0.37	0.25	132.94	0.03	20.13	20.56
2350	0.37	0.26	134.85	0.03	19.99	20.44
2400	0.38	0.26	136.74	0.03	19.85	20.31
2450	0.39	0.27	138.61	0.03	19.71	20.19
2500	0.40	0.28	140.46	0.03	19.58	20.07
2550	0.41	0.29	142.31	0.03	19.45	19.96
2600	0.42	0.29	144.14	0.03	19.32	19.85
2650	0.43	0.30	145.96	0.03	19.19	19.74
2700	0.44	0.31	147.77	0.03	19.07	19.63
2750	0.45	0.32	149.57	0.03	18.95	19.52
2800	0.45	0.32	151.37	0.03	18.84	19.42
2850	0.46	0.33	153.17	0.03	18.72	19.32
2900	0.47	0.34	154.97	0.03	18.61	19.21
2950	0.48	0.34	156.76	0.03	18.50	19.11
3000	0.49	0.35	158.55	0.03	18.39	19.02
3050	0.50	0.36	160.35	0.03	18.29	18.92
3100	0.51	0.36	162.14	0.03	18.18	18.82
3150	0.51	0.37	163.94	0.04	18.08	18.72
3200	0.52	0.38	165.74	0.04	17.98	18.63
3250	0.53	0.38	167.54	0.04	17.89	18.53
3300	0.54	0.39	169.35	0.04	17.79	18.44
3350	0.55	0.39	171.16	0.04	17.69	18.34
3400	0.55	0.40	172.97	0.04	17.60	18.25
3450	0.56	0.41	174.78	0.04	17.51	18.15
3500	0.57	0.41	176.59	0.04	17.42	18.06
3550	0.58	0.42	178.41	0.04	17.33	17.97
3600	0.58	0.42	-179.77	0.04	17.24	17.87
3650	0.59	0.43	-177.96	0.04	17.16	17.78
3700	0.60	0.43	-176.14	0.04	17.07	17.69
3750	0.60	0.43	-174.33	0.04	16.99	17.60
3800	0.61	0.44	-172.52	0.04	16.91	17.51
3850	0.62	0.44	-170.71	0.04	16.83	17.42
3900	0.62	0.45	-168.91	0.04	16.75	17.33
3950	0.63	0.45	-167.11	0.04	16.67	17.25
4000	0.64	0.45	-165.33	0.04	16.59	17.16
4050	0.64	0.46	-163.55	0.04	16.52	17.07
4100	0.65	0.46	-161.79	0.04	16.44	16.99
4150	0.66	0.46	-160.05	0.04	16.37	16.91

**Table 8. Noise Parameters vs Frequency (@ +25 °C, 5 V, 70 mA) (3 of 3)**

Frequency (MHz)	FMIN (dB)	Gamma opt (Mag)	Gamma opt (Phase)	Noise Resistance (RN) (Ω)	Associated Gain (dB)	Maximum Gain (GMAX) (dB)
4200	0.66	0.46	-158.32	0.04	16.30	16.83
4250	0.67	0.47	-156.61	0.04	16.23	16.75
4300	0.68	0.47	-154.92	0.04	16.15	16.67
4350	0.68	0.47	-153.26	0.04	16.09	16.60
4400	0.69	0.47	-151.62	0.04	16.02	16.52
4450	0.70	0.47	-150.02	0.04	15.95	16.45
4500	0.70	0.48	-148.45	0.04	15.89	16.39
4550	0.71	0.48	-146.91	0.04	15.82	16.32
4600	0.72	0.48	-145.42	0.04	15.76	16.26
4650	0.72	0.48	-143.96	0.04	15.70	16.20
4700	0.73	0.48	-142.56	0.04	15.64	16.15
4750	0.74	0.49	-141.21	0.04	15.58	16.10
4800	0.74	0.49	-139.91	0.05	15.52	16.06
4850	0.75	0.49	-138.66	0.05	15.46	16.02
4900	0.76	0.49	-137.48	0.05	15.41	15.98
4950	0.77	0.49	-136.37	0.05	15.35	15.95
5000	0.78	0.50	-135.33	0.05	15.30	15.93
5050	0.79	0.50	-134.36	0.05	15.25	15.91
5100	0.80	0.50	-133.48	0.05	15.20	15.90
5150	0.81	0.51	-132.68	0.06	15.15	15.90
5200	0.82	0.51	-131.97	0.06	15.11	15.90
5250	0.83	0.51	-131.35	0.06	15.06	15.92
5300	0.84	0.52	-130.83	0.06	15.02	15.94
5350	0.85	0.52	-130.42	0.06	14.98	15.97
5400	0.86	0.53	-130.12	0.07	14.94	16.00
5450	0.88	0.53	-129.94	0.07	14.91	16.05
5500	0.89	0.54	-129.88	0.07	14.87	16.11
5550	0.90	0.54	-129.95	0.07	14.84	16.18
5600	0.92	0.55	-130.15	0.08	14.81	16.25
5650	0.93	0.56	-130.49	0.08	14.79	16.35
5700	0.95	0.56	-130.97	0.08	14.76	16.45
5750	0.97	0.57	-131.61	0.09	14.74	16.56
5800	0.99	0.58	-132.41	0.09	14.72	16.69
5850	1.01	0.59	-133.37	0.10	14.71	16.83
5900	1.03	0.60	-134.51	0.10	14.70	16.99
5950	1.05	0.61	-135.82	0.11	14.69	17.16
6000	1.07	0.62	-137.33	0.11	14.68	17.35

Swept F1 Load Gamma Pull  
 Freq = 0.8000 GHz  
 $\Gamma_{Source}$ : 0.2895 < 41.39

Gt max = 27.19 dB  
 at 0.0662 < -167.01  
 5 contours, 1.00 dB step  
 (23.00 to 27.00 dB)  
 Ip3 max = 39.78 dBm  
 at 0.4189 < 92.49  
 5 contours, 0.50 dBm step  
 (37.50 to 39.50 dBm)  
 Specs: OFF

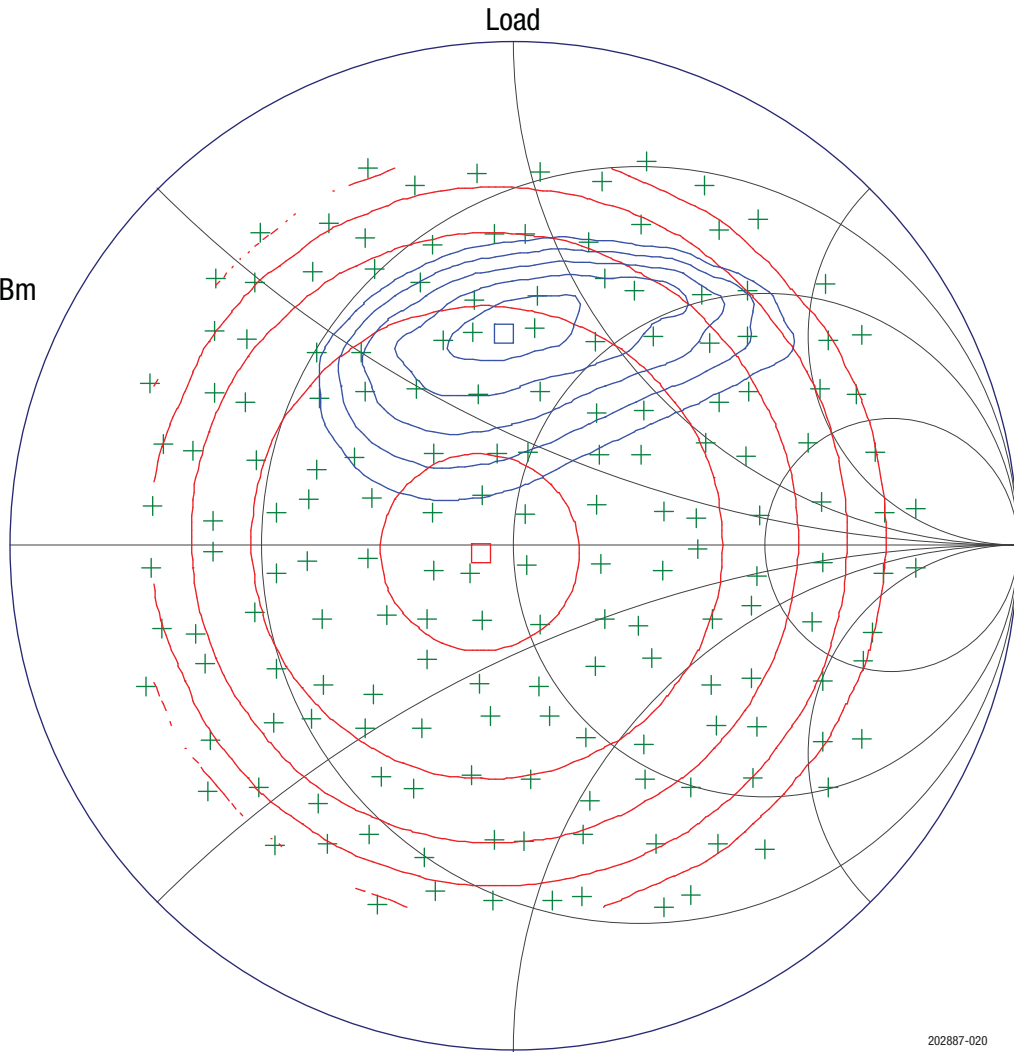

202887-020

**Figure 20. OIP3 Load Pull @ 800 MHz, 5 V, 70 mA (Input Load = Min NF, -20 dBm/tone, 5 MHz Spacing)**

Swept F1 Load Gamma Pull  
 Freq = 1.9000 GHz  
 $\Gamma$ Source: 0.4452 <116.76

Gt max = 21.87 dB  
 at 0.2799 <-122.61  
 5 contours, 1.00 dB step  
 (17.00 to 21.00 dB)  
 Ip3 max = 38.34 dBm  
 at 0.3369 <176.95  
 5 contours, 0.50 dBm step  
 (36.00 to 38.00 dBm)  
 Specs: OFF

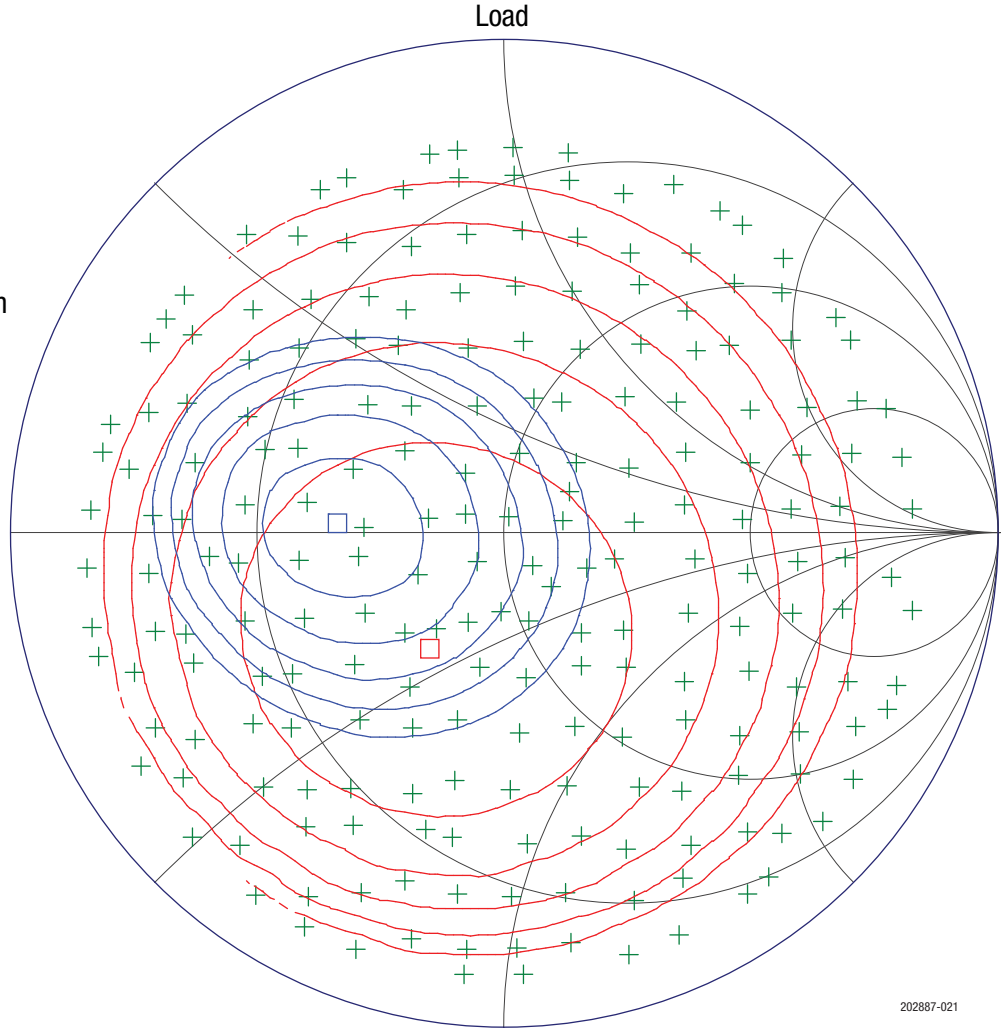

202887-021

**Figure 21. OIP3 Load Pull @ 1900 MHz, 5 V, 70 mA (Input Load = Min NF, -20 dBm/tone, 5 MHz Spacing)**

Swept F1 Load Gamma Pull  
 Freq = 2.6000 GHz  
 $\Gamma$ Source: 0.2658 <143.41

Gt max = 19.48 dB  
 at 0.3518 < 70.99  
 5 contours, 1.00 dB step  
 (15.00 to 19.00 dB)  
 Ip3 max = 36.89 dBm  
 at 0.1195 < 142.13  
 5 contours, 0.50 dBm step  
 (34.50 to 36.50 dBm)  
 Specs: OFF

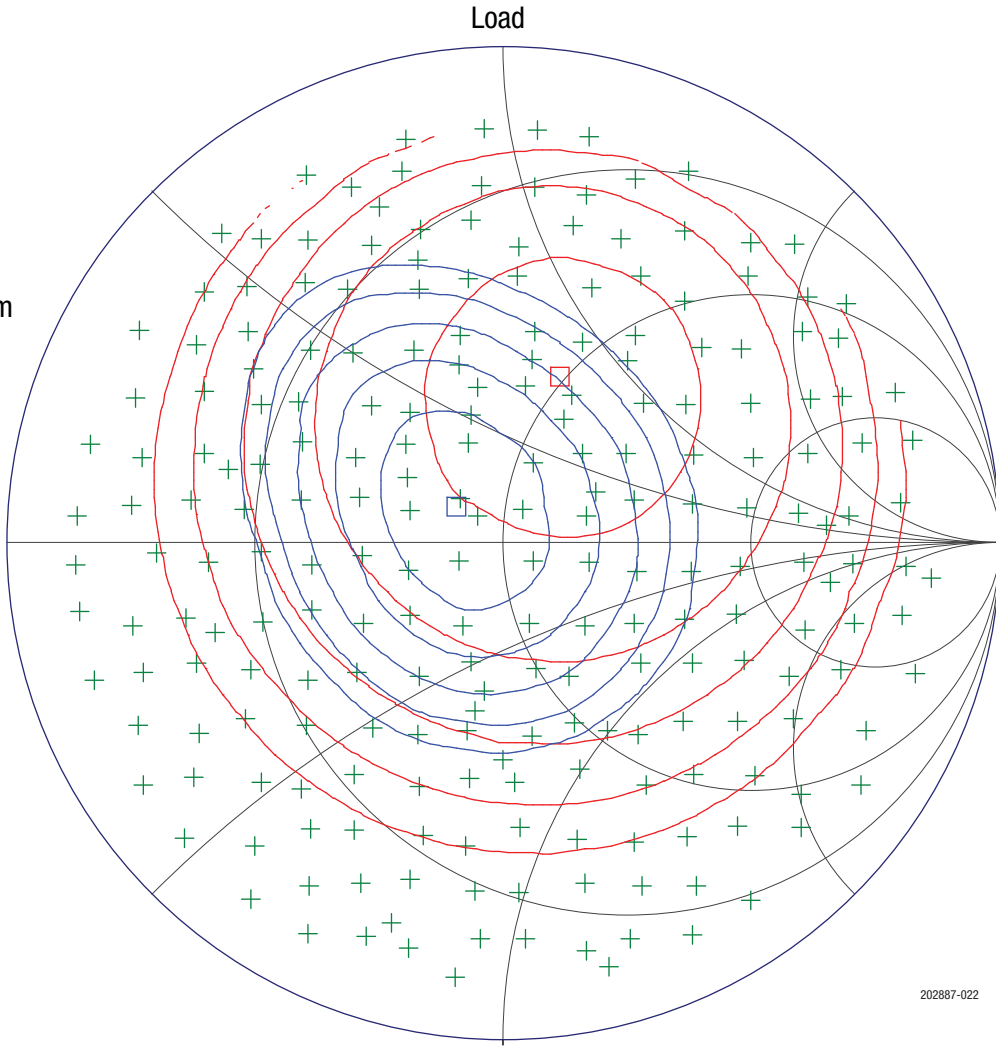

202887-022

**Figure 22. OIP3 Load Pull @ 2600 MHz, 5 V, 70 mA (Input Load = Min NF, -20 dBm/tone, 5 MHz Spacing)**

## Evaluation Board Description

The SKY67153-396LF Evaluation Board is used to test the performance of the SKY67153-396LF LNA. Four different boards are available for different frequency operations: 700 to 1000 MHz, 1600 to 2170 MHz, 2300 to 2700 MHz, and 3400 to 3800 MHz.

An assembly drawing for the Evaluation Board is shown in Figure 23. The layer detail is provided in Figure 24. An Evaluation Board schematic diagram is provided in Figure 25 (500 to 3800 MHz). Tables 9 through 12 provide the Bill of Materials (BOM) list for the four different Evaluation Board tuning frequencies.

## Package Dimensions

The PCB layout footprint for the SKY67153-396LF is provided in Figure 26. Typical part markings are shown in Figure 27. Package dimensions are shown in Figure 28, and tape and reel dimensions are provided in Figure 29.

## Package and Handling Information

Instructions on the shipping container label regarding exposure to moisture after the container seal is broken must be followed. Otherwise, problems related to moisture absorption may occur when the part is subjected to high temperature during solder assembly.

The SKY67153-396LF is rated to Moisture Sensitivity Level 1 (MSL1) at 260 °C. It can be used for lead or lead-free soldering. For additional information, refer to the Skyworks Application Note, *Solder Reflow Information*, document number 200164.

Care must be taken when attaching this product, whether it is done manually or in a production solder reflow environment. Production quantities of this product are shipped in a standard tape and reel format.



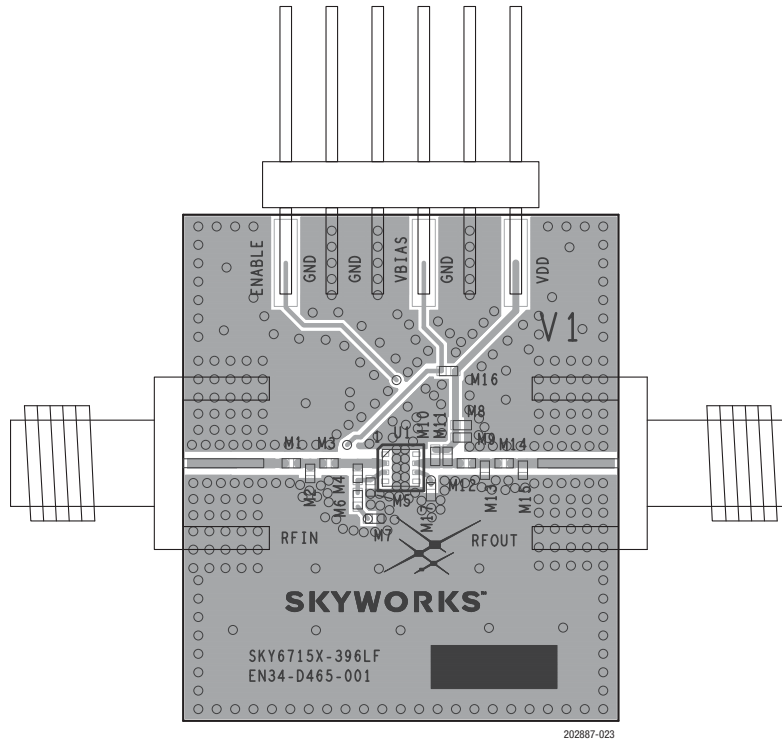

Figure 23. SKY67153-396LF Evaluation Board Assembly Diagram

Cross Section	Name	Thickness (mm)	Material
	MSK-NS		
	TRA-NS	0.03556	Cu foil
	Laminated	0.254 ± 0.152	Rogers 4350B
	TRA-2	0.0178	Cu foil
	Laminated	0.889 nom.	FR4 Prepreg (Note 1)
	TRA-3	0.0178	Cu foil
	Laminated	0.254 ± 0.152	FR4 Core
	TRA-FS	0.0178	Cu foil
	MSK-PS		

Note 1: Adjust this thickness to meet total thickness goal.

General Notes:

Material: Rogers R04350,  $\epsilon_r = 3.66$   
 Layer 1 thickness: 0.254 mm  
 Overall board thickness: 1.575 mm  
 50  $\Omega$  transmission line width: 0.522 mm  
 Coplanar ground spacing: 0.394 mm  
 Via diameter: 0.254 mm

202887-024

Figure 24. Layer Detail Physical Characteristics

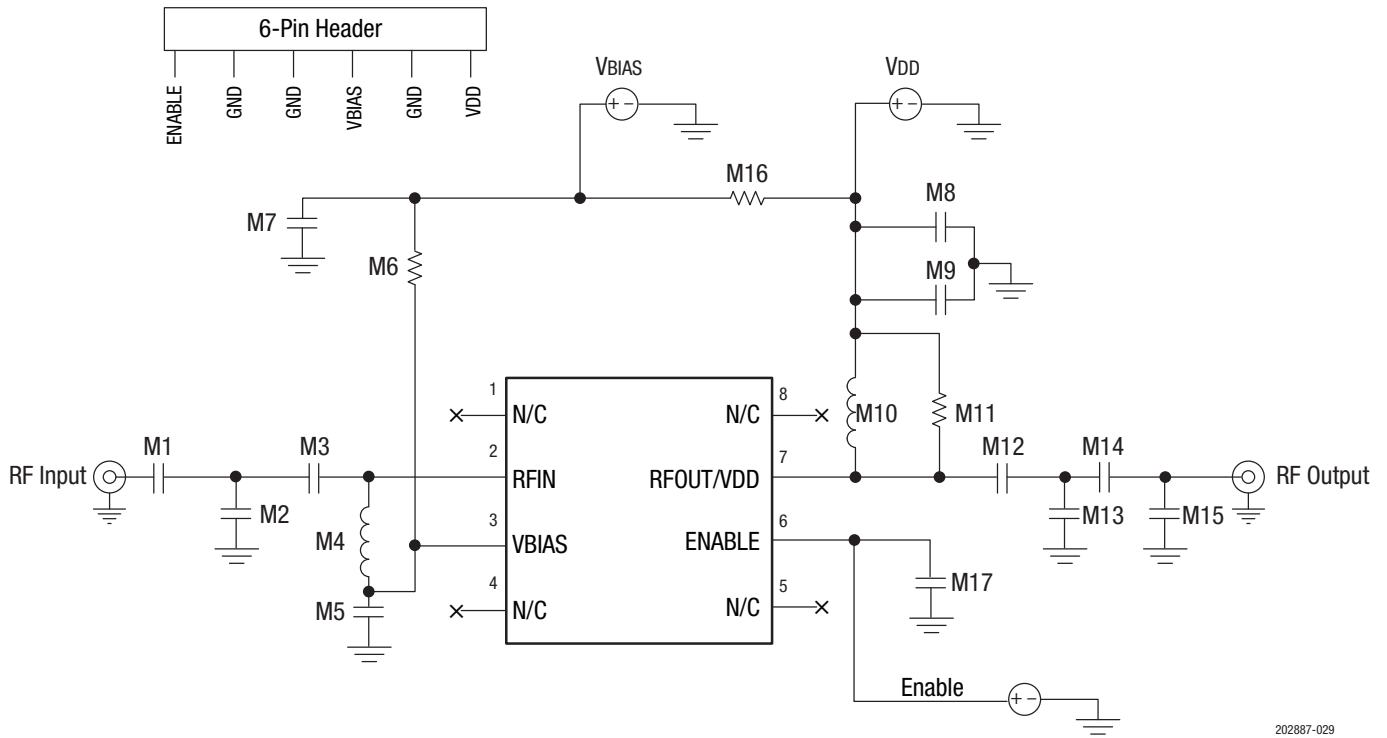

202887-029

Figure 25. SKY67153-396LF Evaluation Board Schematic (700 to 3800 MHz)

Table 9. SKY67153-396LF Evaluation Board Bill of Materials (700 to 1000 MHz Tuning)

Component	Description	Value	Size	Manufacturer	Part Number
M1	Inductor	2.2 nH	0402	Coilcraft	0402HP-2N2XJL
M2	DNI	-	-	-	-
M3	Capacitor	20 pF	0402	Murata	GJM1555C1H200JB01
M4	Inductor	15 nH	0402	Coilcraft	0402HP-15NX_L
M5	Capacitor	68 pF	0402	Murata	GRM1555C1H680JZ01
M6	Resistor	9.1 kΩ	0402	Kamaya	RMC1/16S-912JTH
M7, M8	Capacitor	10000 pF	0402	Murata	GRM155R71H103KA88
M9, M12	Capacitor	100 pF	0402	Murata	GRM1555C1H101JZ01
M10	Inductor	8.2 nH	0402	Murata	LQG15HS8N2J02
M11	Resistor	330 Ω	0402	Kamaya	RMC1/16S-331JTH
M13	Capacitor	1.8 pF	0402	Murata	GJM1555C1H1R8CB01
M14, M16	Resistor	0 Ω	0402	Kamaya	RMC1/16SJPTH
M15	DNI	-	-	-	-
M17	Capacitor	1000 pF	0402	Murata	GRM1555C1H102JZ01

**Table 10. SKY67153-396LF Evaluation Board Bill of Materials (1600 to 2170 MHz Tuning)**

Component	Description	Value	Size	Manufacturer	Part Number
M1	Capacitor	20 pF	0402	Murata	GJM1555C1H200JB01
M2	Capacitor	1 pF	0402	Murata	GJM1555C1H1R0CB01
M3	Inductor	2 nH	0402	Coilcraft	0402HP-2N0XJL
M4	Inductor	10 nH	0402	Coilcraft	0402HP-10NX_L
M5	Capacitor	8.2 pF	0402	Murata	GJM1555C1H8R2DB01
M6	Resistor	10 k $\Omega$	0402	Kamaya	RMC1/16S-103JTH
M7	Capacitor	10000 pF	0402	Murata	GRM155R71H103KA88
M8	Capacitor	1000 pF	0402	Murata	GRM155R71H102KA01
M9	Capacitor	22 pF	0402	Murata	GRM1555C1H220JZ01
M10	Inductor	3.6 nH	0402	Murata	LQG15HS3N6S02
M11	Resistor	1 k $\Omega$	0402	Kamaya	RMC1/16S-102JTH
M12	Capacitor	3.6 pF	0402	Murata	GJM1555C1H3R6CB01
M13	Resistor	2 k $\Omega$	0402	Kamaya	RMC1/16S-202JTH
M14, M16	Resistor	0 $\Omega$	0402	Kamaya	RMC1/16SJPTH
M15	DNI	–	–	–	–
M17	Capacitor	1000 pF	0402	Murata	GRM1555C1H102JZ01

**Table 11. SKY67153-396LF Evaluation Board Bill of Materials (2300 to 2700 MHz Tuning)**

Component	Description	Value	Size	Manufacturer	Part Number
M1	Capacitor	20 pF	0402	Murata	GJM1555C1H200JB01
M2	Capacitor	1.2 pF	0402	Murata	GJM1555C1H1R2CB01
M3	Inductor	1 nH	0402	Coilcraft	0402HP-1N0XJL
M4	Inductor	12 nH	0402	Coilcraft	0402HP-12NX_L
M5	Capacitor	56 pF	0402	Murata	GJM1555C1H560JZ01
M6	Resistor	10 k $\Omega$	0402	Kamaya	RMC1/16S-103JTH
M7	Capacitor	10000 pF	0402	Murata	GRM155R71H103KA88
M8	Capacitor	1000 pF	0402	Murata	GRM155R71H102KA01
M9	Capacitor	22 pF	0402	Murata	GRM1555C1H220JZ01
M10	Inductor	2.7 nH	0402	Murata	LQG15HS2N7S02
M11	Resistor	1 k $\Omega$	0402	Kamaya	RMC1/16S-102JTH
M12	Capacitor	3.9 pF	0402	Murata	GJM1555C1H3R9CZ01
M13	Resistor	2 k $\Omega$	0402	Kamaya	RMC1/16S-202JTH
M14, M16	Resistor	0 $\Omega$	0402	Kamaya	RMC1/16SJPTH
M15	DNI	–	–	–	–
M17	Capacitor	1000 pF	0402	Murata	GRM1555C1H102JZ01

**Table 12. SKY67153-396LF Evaluation Board Bill of Materials (3400 to 3800 MHz Tuning)**

Component	Description	Value	Size	Manufacturer	Part Number
M1	Capacitor	20 pF	0402	Murata	GJM1555C1H200JB01
M2	Capacitor	1 pF	0402	Murata	GJM1555C1H1R0CB01
M3	Capacitor	10 pF	0402	Murata	GJM1555C1H100JB01
M4	Inductor	9 nH	0402	Coilcraft	0402HP-9N0XJL
M5	DNI	-	-	-	-
M6	Resistor	9.1 kΩ	0402	Kamaya	RMC1/16SK910FTH
M7	Capacitor	10000 pF	0402	Murata	GRM155R71H103KA88
M8	Capacitor	1000 pF	0402	Murata	GRM155R71H102KA01
M9	Capacitor	10 pF	0402	Murata	GJM1555C1H100JB01
M10	DNI	-	-	-	-
M11	Inductor	1 nH	0402	Murata	LQG15HS1N0S02
M12	Capacitor	100 pF	0402	Murata	GRM1555C1H101JZ01
M13	Capacitor	0.6 pF	0402	Murata	GJM1555C1HR60BB01
M14, M16	Resistor	0 Ω	0402	Kamaya	RMC1/16SJPTH
M15	DNI	-	-	-	-
M17	Capacitor	1000 pF	0402	Murata	GRM1555C1H102JZ01

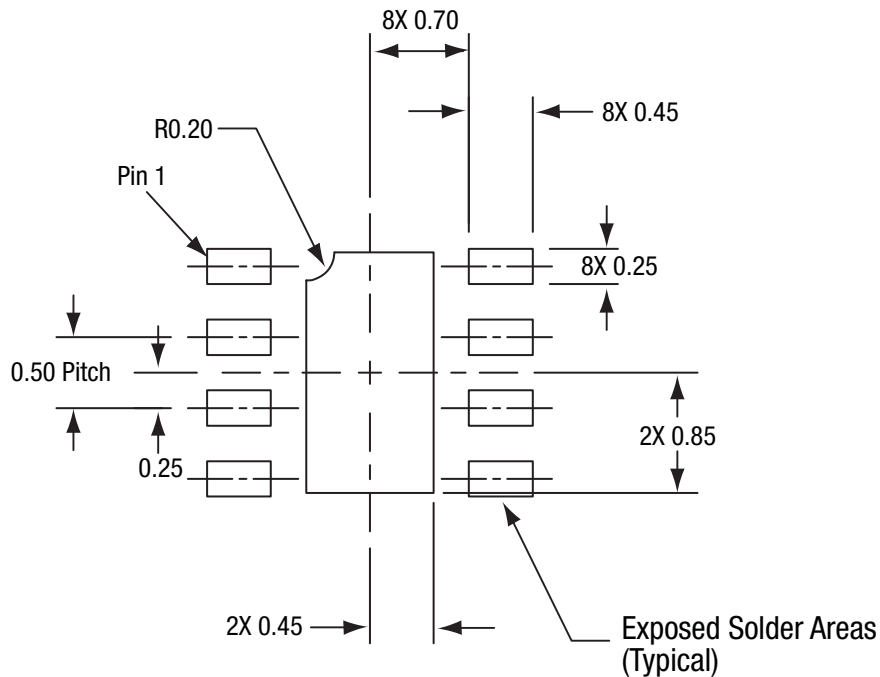

All dimensions are in millimeters

202887-026

**Figure 26. SKY67153-396LF PCB Layout Footprint (Top View)**

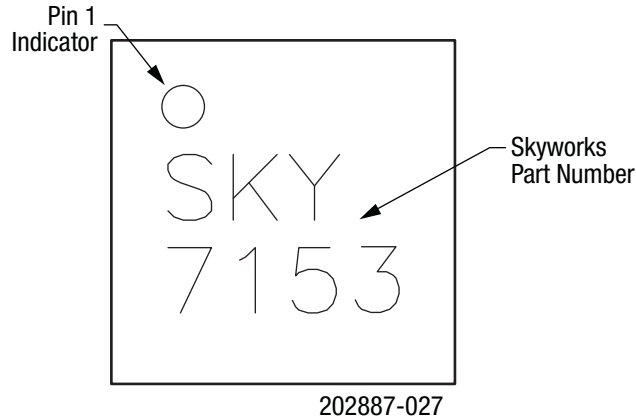

**Figure 27. Typical Part Markings (Top View)**

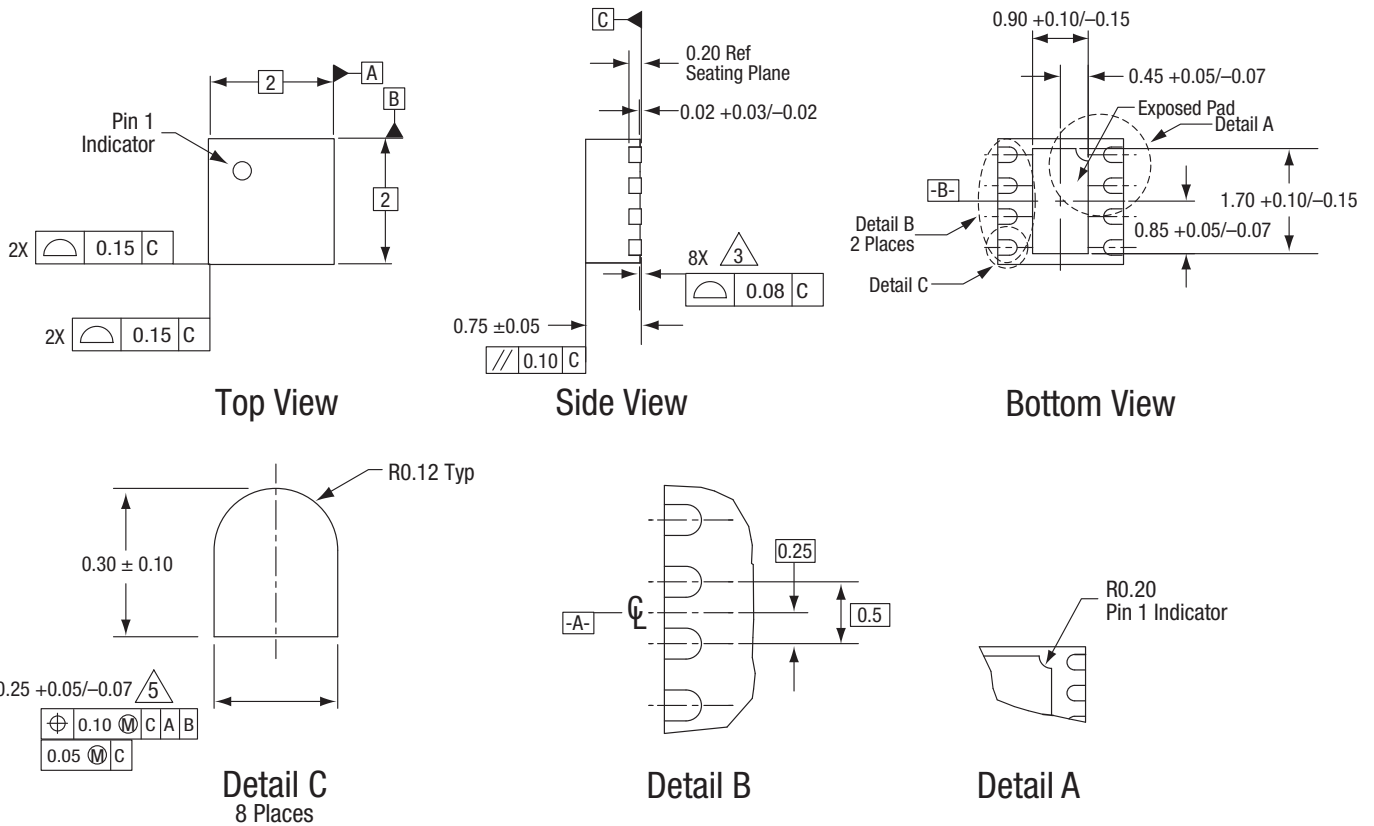

**Notes:**

1. All measurements are in millimeters.
2. Dimensions and tolerances according to ASME Y14.5M-1994.
3. Coplanarity applies to the exposed heat sink ground pad as well as the terminals.
4. Plating requirement per source control drawing (SCD) 2504.
5. Dimension applies to metallized terminal and is measured between 0.15 mm and 0.30 mm from terminal tip.

202887-028

**Figure 28. SKY67153-396LF Package Dimensions**

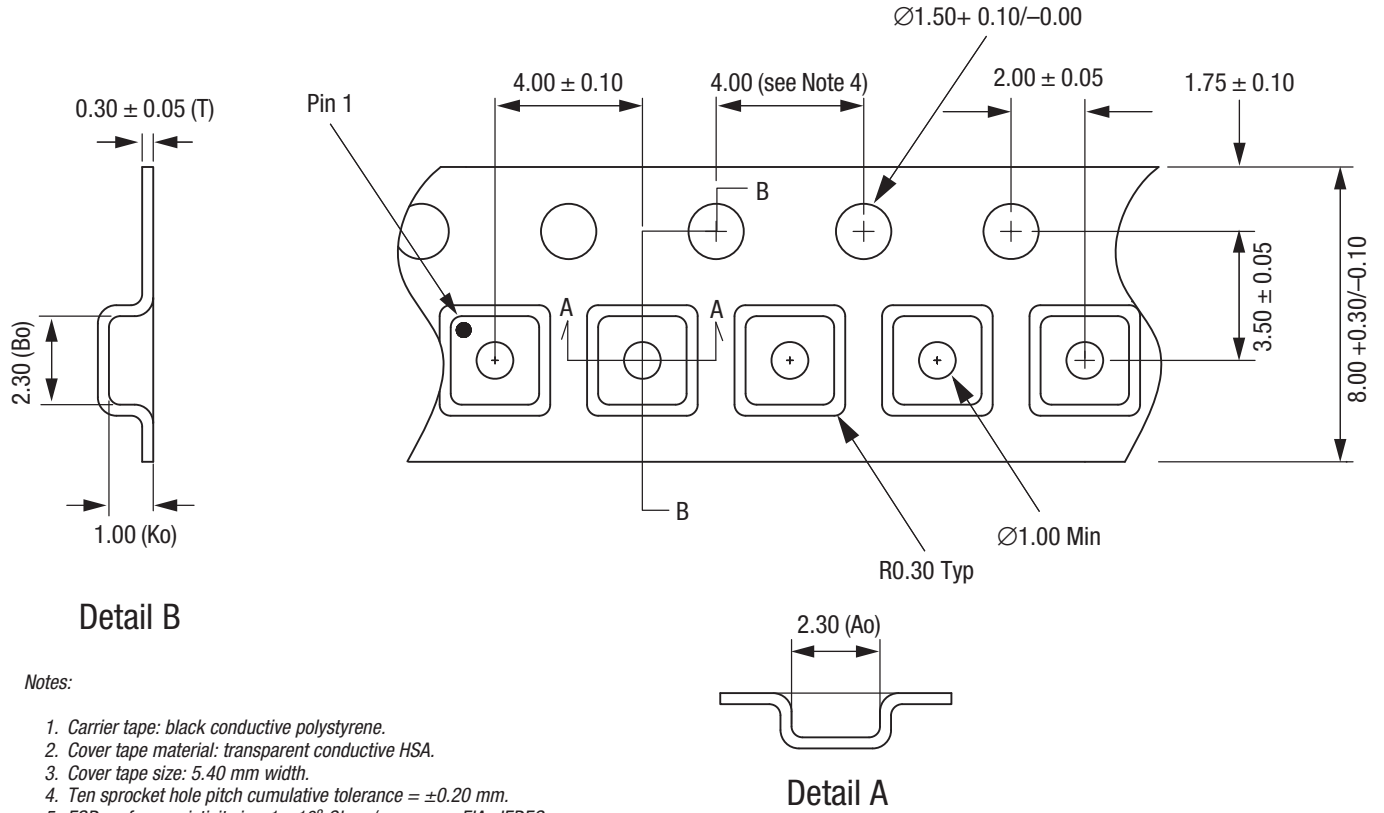

Detail B

Notes:

1. Carrier tape: black conductive polystyrene.
2. Cover tape material: transparent conductive HSA.
3. Cover tape size: 5.40 mm width.
4. Ten sprocket hole pitch cumulative tolerance =  $\pm 0.20$  mm.
5. ESD surface resistivity is  $\leq 1 \times 10^8$  Ohms/square per EIA, JEDEC tape and reel specification.
6. Ao and Bo measurement point to be 0.30 mm from bottom pocket.
7. All measurements are in millimeters.

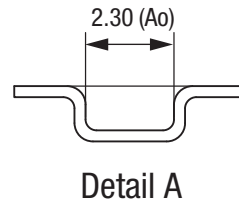

202887-029

Figure 29. SKY67153-396LF Tape and Reel Dimensions

## Ordering Information

Model Name	Manufacturing Part Number	Evaluation Board Part Number
SKY67153-396LF LNA	SKY67153-396LF	SKY67153-396EK1 (700-1000 MHz) SKY67153-396EK2 (1600-2170 MHz) SKY67153-396EK3 (2300-2700 MHz) SKY67153-396EK4 (3400-3800 MHz)

Copyright © 2013-2014, 2016-2017 Skyworks Solutions, Inc. All Rights Reserved.

Information in this document is provided in connection with Skyworks Solutions, Inc. ("Skyworks") products or services. These materials, including the information contained herein, are provided by Skyworks as a service to its customers and may be used for informational purposes only by the customer. Skyworks assumes no responsibility for errors or omissions in these materials or the information contained herein. Skyworks may change its documentation, products, services, specifications or product descriptions at any time, without notice. Skyworks makes no commitment to update the materials or information and shall have no responsibility whatsoever for conflicts, incompatibilities, or other difficulties arising from any future changes.

No license, whether express, implied, by estoppel or otherwise, is granted to any intellectual property rights by this document. Skyworks assumes no liability for any materials, products or information provided hereunder, including the sale, distribution, reproduction or use of Skyworks products, information or materials, except as may be provided in Skyworks Terms and Conditions of Sale.

THE MATERIALS, PRODUCTS AND INFORMATION ARE PROVIDED "AS IS" WITHOUT WARRANTY OF ANY KIND, WHETHER EXPRESS, IMPLIED, STATUTORY, OR OTHERWISE, INCLUDING FITNESS FOR A PARTICULAR PURPOSE OR USE, MERCHANTABILITY, PERFORMANCE, QUALITY OR NON-INFRINGEMENT OF ANY INTELLECTUAL PROPERTY RIGHT; ALL SUCH WARRANTIES ARE HEREBY EXPRESSLY DISCLAIMED. SKYWORKS DOES NOT WARRANT THE ACCURACY OR COMPLETENESS OF THE INFORMATION, TEXT, GRAPHICS OR OTHER ITEMS CONTAINED WITHIN THESE MATERIALS. SKYWORKS SHALL NOT BE LIABLE FOR ANY DAMAGES, INCLUDING BUT NOT LIMITED TO ANY SPECIAL, INDIRECT, INCIDENTAL, STATUTORY, OR CONSEQUENTIAL DAMAGES, INCLUDING WITHOUT LIMITATION, LOST REVENUES OR LOST PROFITS THAT MAY RESULT FROM THE USE OF THE MATERIALS OR INFORMATION, WHETHER OR NOT THE RECIPIENT OF MATERIALS HAS BEEN ADVISED OF THE POSSIBILITY OF SUCH DAMAGE.

Skyworks products are not intended for use in medical, lifesaving or life-sustaining applications, or other equipment in which the failure of the Skyworks products could lead to personal injury, death, physical or environmental damage. Skyworks customers using or selling Skyworks products for use in such applications do so at their own risk and agree to fully indemnify Skyworks for any damages resulting from such improper use or sale.

Customers are responsible for their products and applications using Skyworks products, which may deviate from published specifications as a result of design defects, errors, or operation of products outside of published parameters or design specifications. Customers should include design and operating safeguards to minimize these and other risks. Skyworks assumes no liability for applications assistance, customer product design, or damage to any equipment resulting from the use of Skyworks products outside of stated published specifications or parameters.

Skyworks and the Skyworks symbol are trademarks or registered trademarks of Skyworks Solutions, Inc., in the United States and other countries. Third-party brands and names are for identification purposes only, and are the property of their respective owners. Additional information, including relevant terms and conditions, posted at [www.skyworksinc.com](http://www.skyworksinc.com), are incorporated by reference.

# Mouser Electronics

Authorized Distributor

Click to View Pricing, Inventory, Delivery & Lifecycle Information:

[Skyworks:](#)

[SKY67153-396LF](#)