

Professionally approved products.

Datasheet

Dimmable Constant Voltage LED Driver 240W 24V 5 → 10A RS HLG-240H-24A

RS Stock number 764-7366



■ Features :

- Universal AC input | Full range (up to 305VAC)
- Built-in active PFC function
- Protections: Short circuit | Over current | Over voltage | Over temperature
- Cooling by free air convection
- OCP point adjustable through output cable or internal potentiometer
- IP67 | IP65 design for indoor or outdoor installations
- Three in one dimming function (1-10Vdc or PWM signal or resistance)
- Suitable for LED lighting and street lighting applications
- Compliance to worldwide safety regulations for lighting
- Suitable for dry | damp | wet locations
- Type "HL" for use in class I , Division 2 hazardous(Classified) location luminaires

HLG-240H-12 Blank : IP67 rated. Cable for IIO connection.

A : IP65 rated. Output voltage and constant current level can be adjusted through internal potentiometer.

B : IP67 rated. Constant current level adjustable through output cable with 1-10Vdc or 10V PWM signal or resistance.

Professionally approved products.

Datasheet

MODEL		764-7350	764-7369	764-7362	764-7366	764-7375	764-7378	764-7372	764-7381	764-7384	
OUTPUT	DC VOLTAGE	12V	15V	20V	24V	30V	36V	42V	48V	54V	
	CONSTANT CURRENT REGION <small>Note 4</small>	6 ~ 12V	7.5 ~ 15V	10 ~ 20V	12 ~ 24V	15 ~ 30V	18 ~ 36V	21 ~ 42V	24 ~ 48V	27 ~ 54V	
	RATED CURRENT	16A	15A	12A	10A	8A	6.7A	5.72A	5A	4.45A	
	RATED POWER	192W	225W	240W	240W	240W	241.2W	240.24W	240W	240.3W	
	RIPPLE & NOISE (max.) <small>Note 2</small>	150mVp-p	150mVp-p	150mVp-p	150mVp-p	200mVp-p	250mVp-p	250mVp-p	250mVp-p	350mVp-p	
	VOLTAGE ADJ. RANGE <small>Note 6</small>	11.2 ~ 12.8V	14 ~ 16V	18.6 ~ 21.4V	22.4 ~ 25.6V	28 ~ 32V	33.5 ~ 38.5V	39 ~ 45V	44.8 ~ 51.2V	50 ~ 57V	
	CURRENT ADJ. RANGE	Can be adjusted by internal potentiometer or through output cable									
		8 ~ 16A	7.5 ~ 15A	6 ~ 12A	5 ~ 10A	4 ~ 8A	3.3 ~ 6.7A	2.86 ~ 5.72A	2.5 ~ 5A	2.23 ~ 4.45A	
	VOLTAGE TOLERANCE <small>Note 3</small>	±2.5%	±2.0%	±1.0%	±1.0%	±1.0%	±1.0%	±1.0%	±1.0%	±1.0%	
	LINE REGULATION	±0.5%	±0.5%	±0.5%	±0.5%	±0.5%	±0.5%	±0.5%	±0.5%	±0.5%	
LOAD REGULATION <small>Note 8</small>	±2.0%	±1.5%	±1.0%	±0.5%	±0.5%	±0.5%	±0.5%	±0.5%	±0.5%		
SETUP, RISE TIME <small>Note 9</small>	2500ms, 80ms at full load 230VAC / 115VAC										
HOLD UP TIME (Typ.)	15ms at full load 230VAC / 115VAC										
INPUT	VOLTAGE RANGE <small>Note 5</small>	90 ~ 305VAC		127 ~ 431VDC							
	FREQUENCY RANGE	47 ~ 63Hz									
	POWER FACTOR (Typ.)	PF>0.98/115VAC, PF>0.95/230VAC at full load (Please refer to "Power Factor Characteristic" curve)									
	EFFICIENCY (Typ.)	90%	90%	92%	93%	93%	93%	93%	93.5%	94%	
	AC CURRENT (Typ.)	4A / 115VAC		2A / 230VAC		1.2A / 277VAC					
	INRUSH CURRENT (Typ.)	COLD START 75A/230VAC									
	LEAKAGE CURRENT	<0.75mA / 277VAC									
PROTECTION	OVER CURRENT <small>Note 4</small>	95 ~ 108%									
		Protection type : Constant current limiting, recovers automatically after fault condition is removed									
	SHORT CIRCUIT	Hiccup mode, recovers automatically after fault condition is removed									
	OVER VOLTAGE	13.5 ~ 18V	17.5 ~ 21.5V	23.5 ~ 27.5V	27 ~ 34V	33 ~ 39V	43 ~ 49V	48 ~ 54V	55 ~ 63V	60 ~ 67V	
	Protection type : Shut down and latch off o/p voltage, re-power on to recover										
OVER TEMPERATURE	105°C ±5°C (TSW1)			95°C ±5°C (TSW1)							
	Protection type : Shut down o/p voltage, recovers automatically after temperature goes down										
ENVIRONMENT	WORKING TEMP.	-40 ~ +70°C (Refer to "Derating Curve")									
	WORKING HUMIDITY	20 ~ 95% RH non-condensing									
	STORAGE TEMP., HUMIDITY	-40 ~ +80°C, 10 ~ 95% RH									
	TEMP. COEFFICIENT	±0.03%/°C (0 ~ 50°C)									
	VIBRATION	10 ~ 500Hz, 5G 12min./1cycle, period for 72min. each along X, Y, Z axes									
SAFETY & EMC	SAFETY STANDARDS <small>Note 7</small>	UL1012, CAN/CSA-C22.2 No. 107.1-01, UL8750, CSA C22.2 No. 250.0-08, TUV EN61347-1, EN61347-2-13 independent (except for HLG-240H-C type), UL60950-1, UL8750, TUV EN60950-1, IP65 or IP67, J61347-1, J61347-2-13 approved									
	WITHSTAND VOLTAGE	I/P-O/P: 3.75KVAC		I/P-FG: 1.8KVAC		O/P-FG: 0.5KVAC					
	ISOLATION RESISTANCE	I/P-O/P, I/P-FG, O/P-FG: 100M Ohms / 500VDC / 25°C / 70% RH									
	EMC EMISSION	Compliance to EN55015, EN55022 (CISPR22) Class B, EN61000-3-2 Class C (≥50% load) ; EN61000-3-3									
	EMC IMMUNITY	Compliance to EN61000-4-2, 3, 4, 5, 6, 8, 11, EN61547, EN55024, light industry level (surge 4KV), criteria A									
OTHERS	MTBF	207.9Khrs min. MIL-HDBK-217F (25°C)									
	DIMENSION	244.2*68*38.8mm (L*W*H)(HLG-240H-Blank/A/B)				251*68*38.8mm (L*W*H)(HLG-240H-C)					
	PACKING	1.3Kg, 12pcs/16.6Kg/0.84CUFT(HLG-240-Blank/A/B)				1.23Kg, 12pcs/15.8Kg/1.16CUFT(HLG-240-C)					

Professionally approved products.

Datasheet

Mechanical Specification

Case No.994C Unit:mm

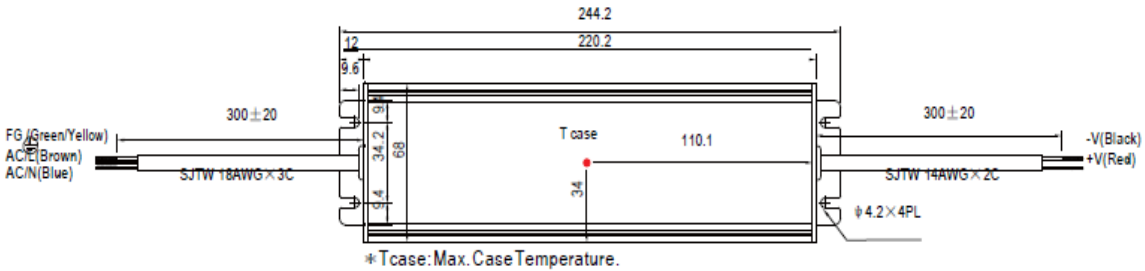
Blank:(HLG-240H)

※ IP67 rated. Cable for I/O connection.

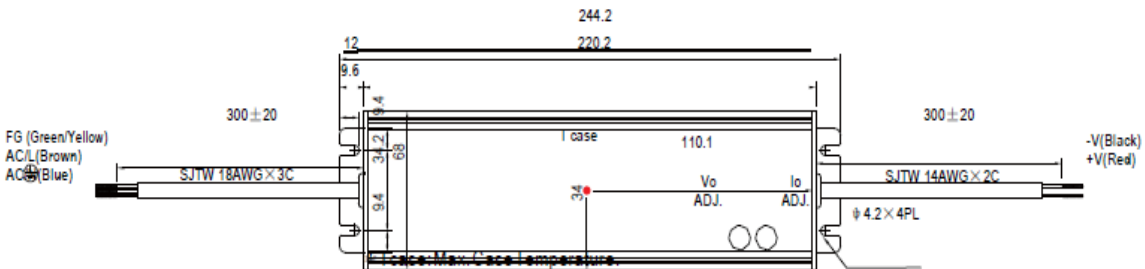
A Type:(HLG-240H_A)

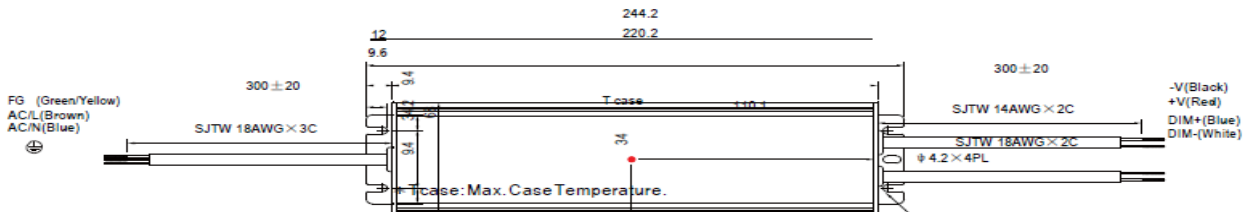
 ※ IP65 rated. Output voltage and constant current level can be adjusted through internal potentiometer.
 (Can access by removing the rubber stopper on the case.)

B Type:(HLG-240H_B)

Professionally approved products.

Datasheet

C Type:(HLG-240_C)



*Tcase:Max. Case Temperature.

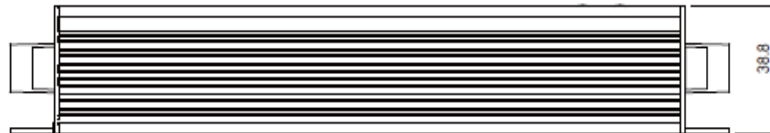

* Output voltage and constant current level can be adjusted through internal potentiometer.
(Can access by removing the rubber stopper on the case.)

AC Input Terminal Pin No. Assignment

Pin No.	Assignment
1	FG —
2	AC/L
3	AC/N

DC Output Terminal Pin No. Assignment

Pin No.	Assignment
1	-V
2	+V

D Type(option):(HLG-240H_D)

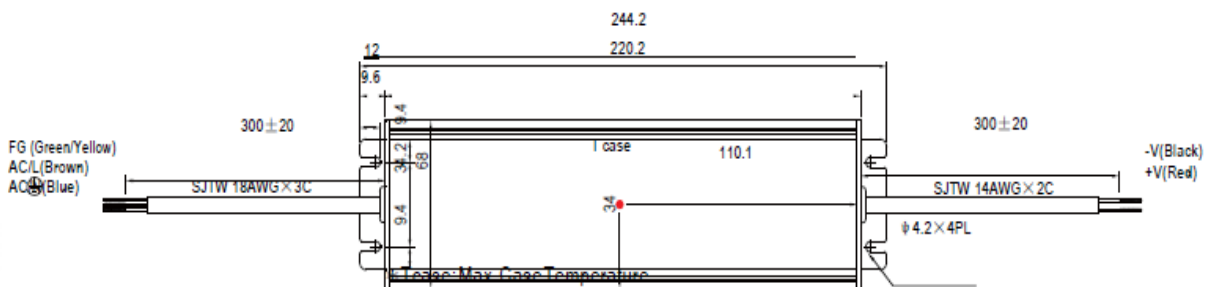

*Tcase:Max. Case Temperature

* IP67 rated. Timer dimming function, contact MEAN WELL for details.

Professionally approved products. Datasheet

Block Diagram

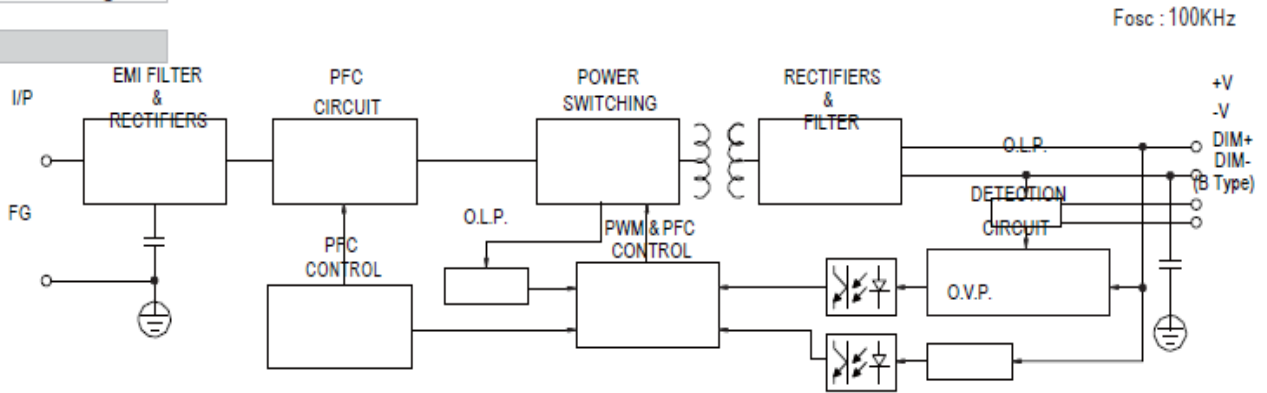

Derating Curve

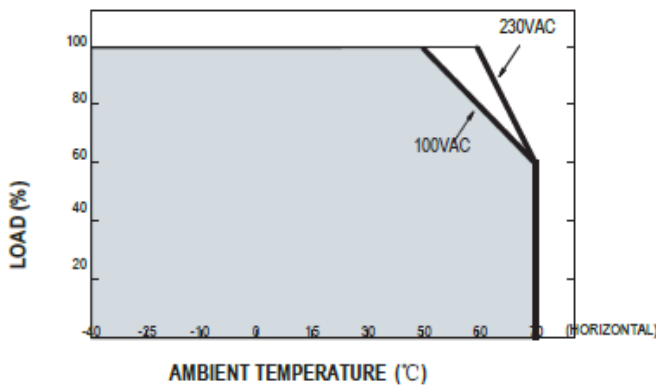

Static Characteristics

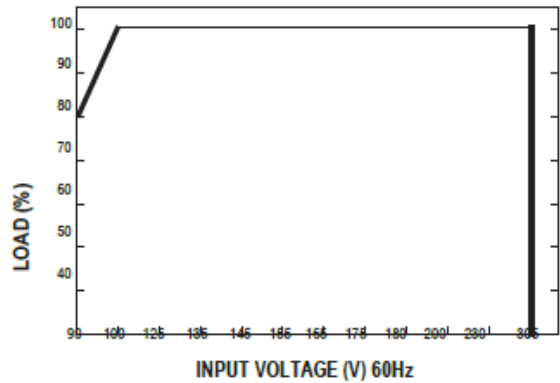

Power Factor Characteristic

Constant Current Mode

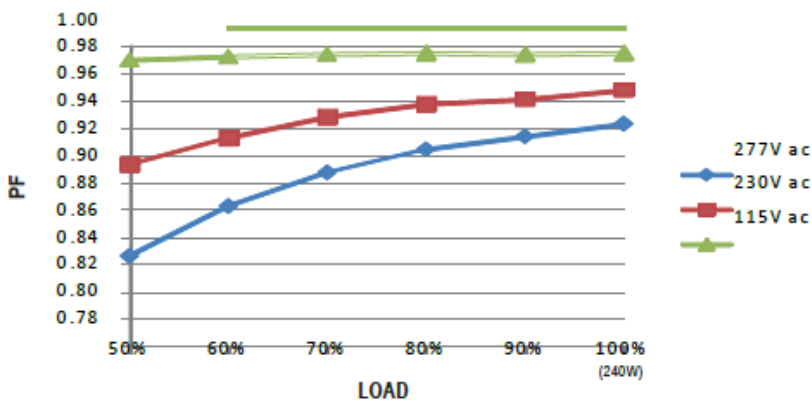

Professionally approved products. Datasheet

EFFICIENCY vs LOAD (48V Model)

■ HLG-240H series possess superior working efficiency that up to 93.5% can be reached in field applications.

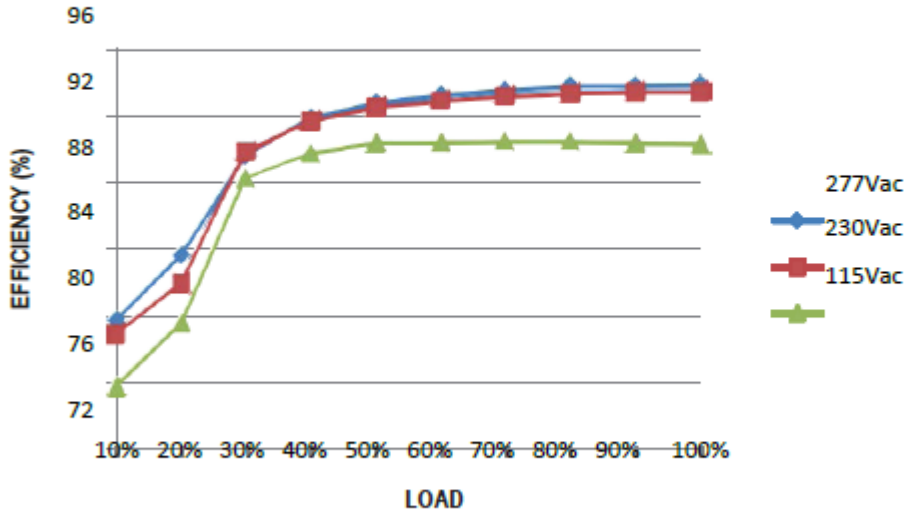

DRIVING METHODS OF LED MODULE

There are two major kinds of LED drive method "direct drive" and "with LED driver".
 A typical LED power supply may either work in "constant voltage mode (CV) or constant current mode (CC)" to drive the LEDs.
 Mean Well's LED power supply with CV+ CC characteristic can be operated at both CV mode (with LED driver, at area (A) and CC mode (direct drive, at area (B)).

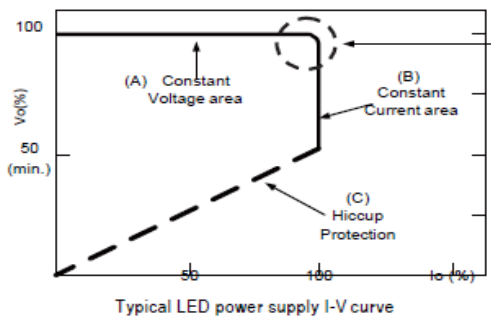

In the constant current region, the highest voltage at the output of the driver depends on the configuration of the end systems.

DIMMING OPERATION (for B-type only)

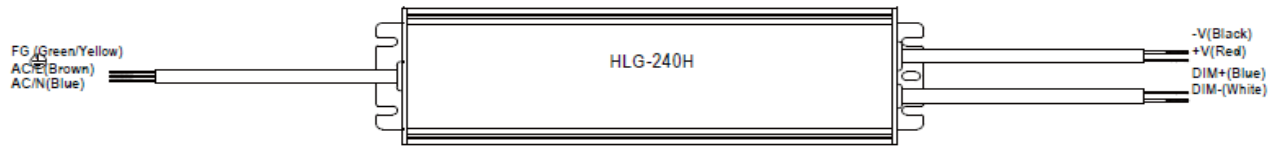

Professionally approved products. Datasheet

※ Built-in 3 in 1 dimming function, IP67 rated. Output constant current level can be adjusted through output cable by connecting a resistance or 1 ~ 10Vdc or 10V PWM signal between DIM+ and DIM-.

※ Please DO NOT connect "DIM-" to "-V".

※ Reference resistance value for output current adjustment (Typical)

Resistance value	Single driver	10K Ω	20K Ω	30K Ω	40K Ω	50K Ω	60K Ω	70K Ω	80K Ω	90K Ω	100K Ω	OPEN
	Multiple drivers (N/A for quantity for synchronized dimming operation)	10K Ω /N	20K Ω /N	30K Ω /N	40K Ω /N	50K Ω /N	60K Ω /N	70K Ω /N	80K Ω /N	90K Ω /N	100K Ω /N	-----
Percentage of rated current		10%	20%	30%	40%	50%	60%	70%	80%	90%	100%	95%~108%

※ 1 ~ 10V dimming function for output current adjustment (Typical)

Dimming value	1V	2V	3V	4V	5V	6V	7V	8V	9V	10V	OPEN
Percentage of rated current	10%	20%	30%	40%	50%	60%	70%	80%	90%	100%	95%~108%

※ 10V PWM signal for output current adjustment (Typical): Frequency range : 100Hz ~ 3KHz

Duty value	10%	20%	30%	40%	50%	60%	70%	80%	90%	100%	OPEN
Percentage of rated current	10%	20%	30%	40%	50%	60%	70%	80%	90%	100%	95%~108%

※ Using the built-in dimming function on B-type model can't turn the lighting fixture totally dark. Please refer to the connection method below to achieve 0% brightness of the lighting fixture connecting to the LED power supply unit.

※ Direct connecting to LEDs is suggested, but is not suitable for using additional drivers. Dimming connection diagram for turning the lighting fixture ON/OFF :

N FG L

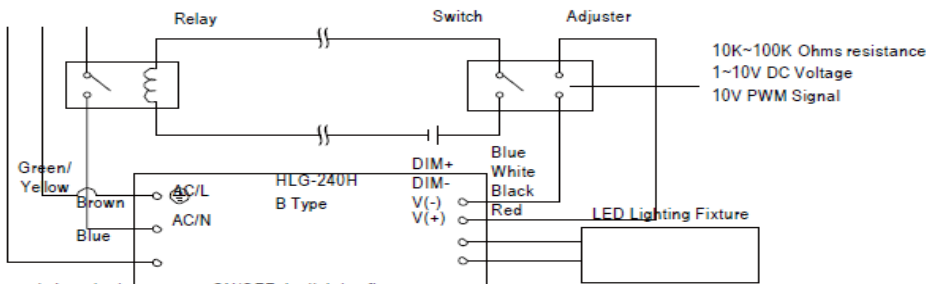

Using a switch and relay can turn ON/OFF the lighting fixture.

1. Output constant current level can be adjusted through output cable by connecting a resistance or 1~10Vdc or 10V PWM signal between DIM+ and DIM-.
2. The LED lighting fixture can be turned ON/OFF by the switch.

WATERPROOF CONNECTION

◎ Waterproof connector

Waterproof connector can be assembled on the output cable of HLG-240H to operate in dry/wet/damp or outdoor environment.

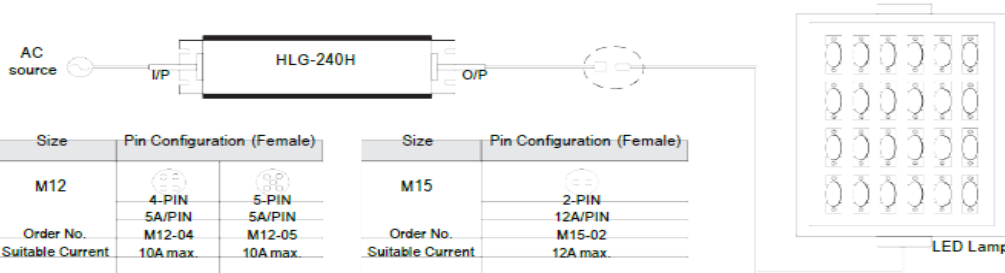

◎ Cable Joiner

