

# SMD Power Inductor CD43

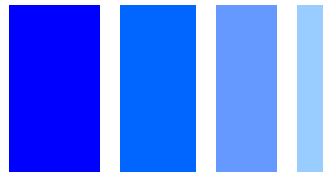

## Description

- Ferrite drum core construction.
- Magnetically unshielded.
- L × W × H: 4.8 × 4.3 × 3.5mm Max.
- Product weight :165mg(Ref.)
- Moisture Sensitivity Level: 1
- RoHS compliance.

## Dimension - [mm]

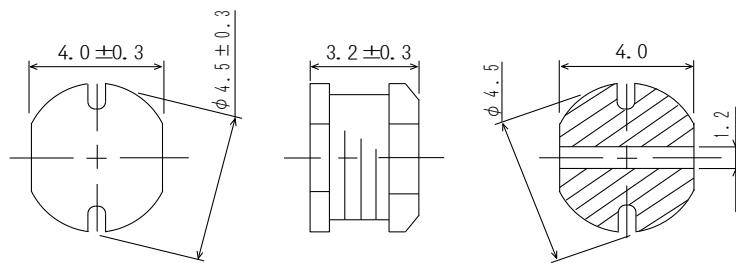

## Land pattern and Schematics - [mm]

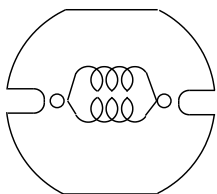
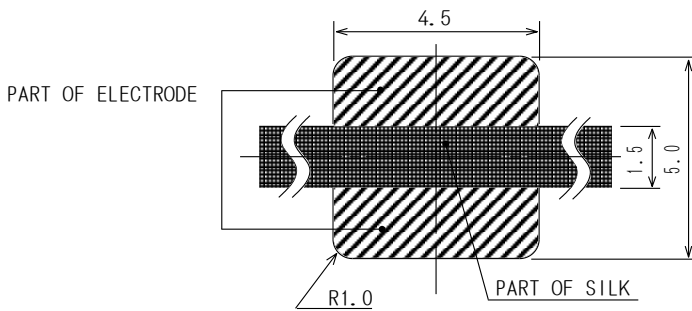

(1.0μH ~ 8.2μH)

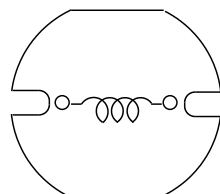

(10μH ~ 68μH)

## Environmental Data

- Operating temperature range: -40°C ~ +100°C (including coil's self temperature rise)
- Storage temperature range: -40°C ~ +100°C
- Solder reflow temperature: 260 °C peak.

## Packaging

- Carrier tape and reel packaging.
- 12.9" diameter reel
- 1500pcs per reel

## Applications

- Ideally used in Mobilephone, PDA, MP3, DSC/DVC, portable DVD etc as DC-DC Converter inductors.



## Electrical Characteristics

Part Name	Stamp	Inductance ( $\mu\text{H}$ ) [Within]※1	D.C.R. (m $\Omega$ ) [Max.] (20 $^{\circ}\text{C}$ )	Rated Current (A) ※2
CD43NP-1R0MC	1R0	1.0 $\pm$ 20%	48.7	2.70
CD43NP-1R4MC	1R4	1.4 $\pm$ 20%	56.2	2.50
CD43NP-1R8MC	1R8	1.8 $\pm$ 20%	63.7	2.33
CD43NP-2R2MC	2R2	2.2 $\pm$ 20%	71.2	2.25
CD43NP-2R7MC	2R7	2.7 $\pm$ 20%	78.7	2.16
CD43NP-3R3MC	3R3	3.3 $\pm$ 20%	86.2	2.00
CD43NP-3R9MC	3R9	3.9 $\pm$ 20%	93.7	1.84
CD43NP-4R7MC	4R7	4.7 $\pm$ 20%	108.7	1.62
CD43NP-5R6MC	5R6	5.6 $\pm$ 20%	125.7	1.48
CD43NP-6R8MC	6R8	6.8 $\pm$ 20%	131.2	1.43
CD43NP-8R2MC	8R2	8.2 $\pm$ 20%	146.2	1.37
CD43NP-100MC	100	10 $\pm$ 20%	182	1.04
CD43NP-120MC	120	12 $\pm$ 20%	210	0.97
CD43NP-150MC	150	15 $\pm$ 20%	235	0.85
CD43NP-180MC	180	18 $\pm$ 20%	338	0.74
CD43NP-220MC	220	22 $\pm$ 20%	378	0.68
CD43NP-270MC	270	27 $\pm$ 20%	522	0.62
CD43NP-330KC	330	33 $\pm$ 10%	540	0.56
CD43NP-390KC	390	39 $\pm$ 10%	587	0.52
CD43NP-470KC	470	47 $\pm$ 10%	844	0.44
CD43NP-560KC	560	56 $\pm$ 10%	937	0.42
CD43NP-680KC	680	68 $\pm$ 10%	1117	0.37

※1: Inductance measuring frequency: 1.0 $\mu\text{H}$  ~ 8.2 $\mu\text{H}$  ; at 7.96 MHz.  
10 $\mu\text{H}$  ~ 68 $\mu\text{H}$  ; at 2.52 MHz.

※2: Rated current: The DC current at which the inductance decreases to 90 % of its initial value or when  $\Delta t=40^{\circ}\text{C}$ , whichever is lower ( $T_a=20^{\circ}\text{C}$ ).

# SMD Power Inductor CD43

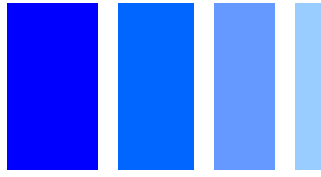

## Saturation Current & Temperature Rise Graph

— L (20°C) — L (105°C) —  $\Delta T$

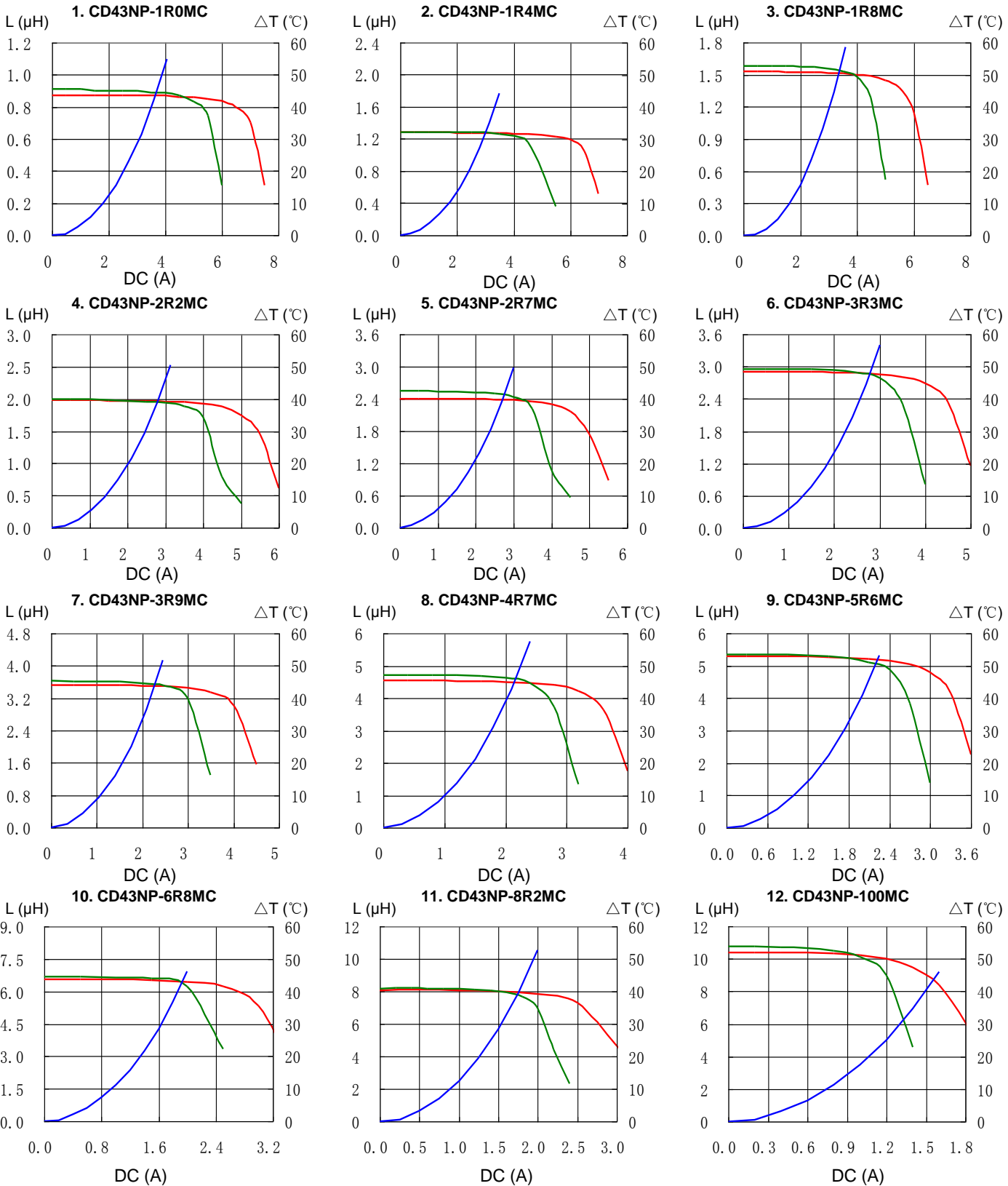

# SMD Power Inductor CD43

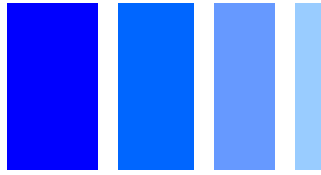

## Saturation Current & Temperature Rise Graph

— L (20°C) — L (105°C) —  $\Delta T$

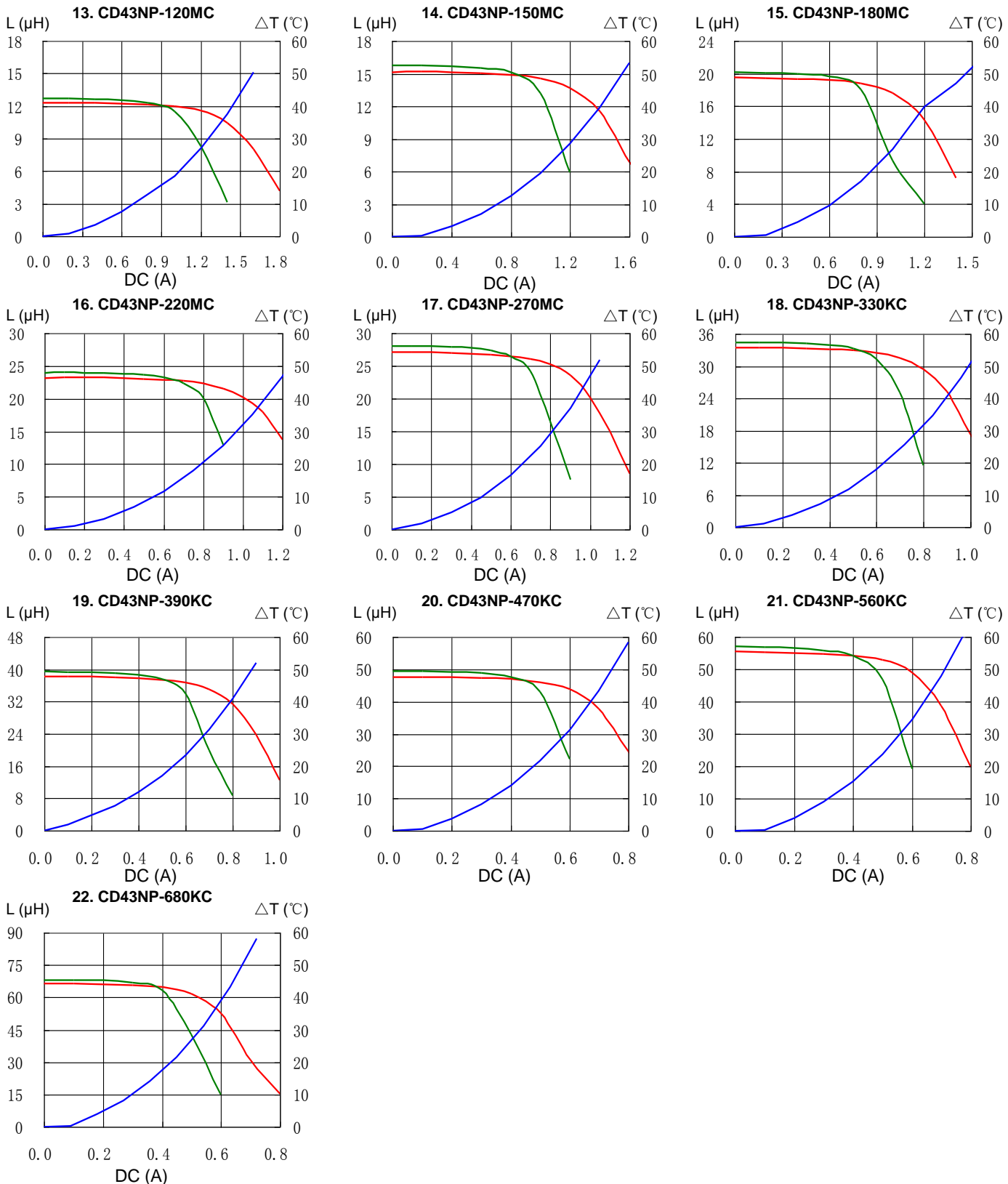

# SMD Power Inductor CD43

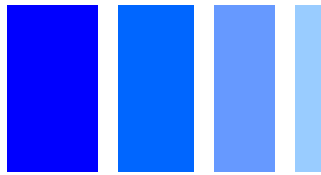

## Solder Reflow Condition

**Heat Endurance**

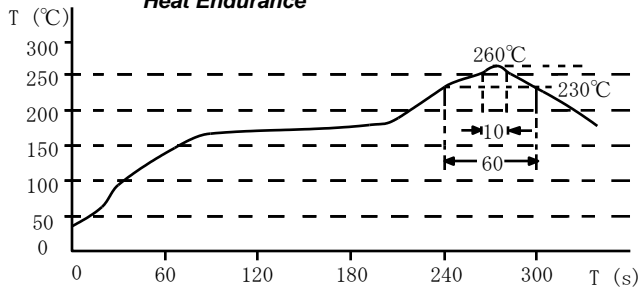

**Temperature Chart**

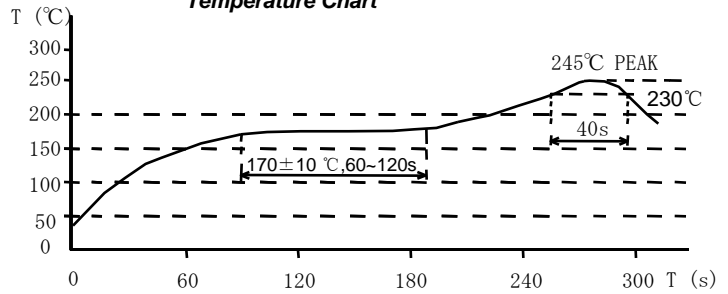

Please refer to the sales offices on our website - <http://www.sumida.com>

### Hong Kong

Tel. +852-2880-6781  
FAX. +852-2565-9600  
[sales@hk.sumida.com](mailto:sales@hk.sumida.com)

### Saitama(Japan)

Tel. +81-48-691-7300  
FAX. +81-48-691-7340  
[sales@jp.sumida.com](mailto:sales@jp.sumida.com)

### Chicago

Tel. +1-847-545-6700  
FAX. +1-847-545-6720  
[sales@us.sumida.com](mailto:sales@us.sumida.com)

### Shanghai

Tel. +86-21-5836-3299  
FAX. +86-21-5836-3266  
[shanghai.sales@cn.sumida.com](mailto:shanghai.sales@cn.sumida.com)

### Seoul

Tel. +82-2-6237-0777  
FAX. +82-2-6237-0778  
[sales@kr.sumida.com](mailto:sales@kr.sumida.com)

### Obernzell

Tel. +49-8591-937-0  
FAX. +49-8591-937-103  
[contact@eu.sumida.com](mailto:contact@eu.sumida.com)

### Shenzhen

Tel. +86-755-8291-0228  
FAX. +86-755-8291-0338  
[shenzhen.sales@cn.sumida.com](mailto:shenzhen.sales@cn.sumida.com)

### Singapore

Tel. +65-6296-3388  
FAX. +65-6841-4426  
[sales@sg.sumida.com](mailto:sales@sg.sumida.com)

### Neumarkt

Tel. +49-9181-4509-110  
FAX. +49-9181-4509-310  
[infocomp@eu.sumida.com](mailto:infocomp@eu.sumida.com)

### Taipei

Tel. +886-2-8751-2737  
FAX. +886-2-8751-2738  
[sales@tw.sumida.com](mailto:sales@tw.sumida.com)

### San Jose

Tel. +1-408-321-9660  
FAX. +1-408-321-9308  
[sales@us.sumida.com](mailto:sales@us.sumida.com)

# Mouser Electronics

Authorized Distributor

Click to View Pricing, Inventory, Delivery & Lifecycle Information:

Sumida:

[CD43NP-680KC](#) [CD43NP-470KC](#) [CD43NP-100MC](#) [CD43NP-3R9MC](#) [CD43NP-220MC](#)