

# GW QSSPA1.WB

## OSCONIQ® P 3030

The OSCONIQ P 3030 Colors family LED comes with well known superior robustness, high reliability, long lifetime, low thermal resistance. Compact and proven 3mm x 3mm package and established footprint. Perfectly addressing applications that demand for high efficiency and long lifetime.



### Applications

- Accent (BAR)
- Architecture
- Architecture / Garden Lighting (LED & Laser)
- Medical Illumination
- Photo Therapy
- Stage Lighting (LED & Laser)

### Features:

- Package: SMD epoxy package
- Typ. Radiation: 120°
- Corrosion Robustness Class: 3B
- Lumen maintenance: Test results according to IESNA LM-80 available
- ESD: 8 kV acc. to ANSI/ESDA/JEDEC JS-001 (HBM, Class 3B)
- Luminous Flux: typ. 180 lm
- Luminous Efficacy: typ. 180 lm/W

---

## Ordering Information

Type	Luminous Flux <sup>1)</sup> $I_F = 350 \text{ mA}$ $\Phi_V$	Ordering Code
GW QSSPA1.WB-LUMU-MCML-1	164 ... 280 lm	Q65112A9195
GW QSSPA1.WB-LUMU-MMMW-1	164 ... 280 lm	Q65112A9197

## Maximum Ratings

Parameter	Symbol		Values
Operating Temperature	$T_{op}$	min. max.	-40 °C 125 °C
Storage Temperature	$T_{stg}$	min. max.	-40 °C 125 °C
Junction Temperature	$T_j$	max.	135 °C
Forward current	$I_F$	min. max.	100 mA 1300 mA
Surge Current $t \leq 10 \mu s$ ; $D = 0.005$ ; $T_j = 25 \text{ °C}$	$I_{FS}$	max.	2000 mA
Reverse voltage <sup>2)</sup>	$V_R$		Not designed for reverse operation
ESD withstand voltage acc. to ANSI/ESDA/JEDEC JS-001 (HBM, Class 3B)	$V_{ESD}$		8 kV

## Characteristics

$I_F = 350 \text{ mA}$ ;  $T_J = 25 \text{ °C}$

Parameter	Symbol		Values
Viewing angle at 50% $I_V$	$2\phi$	typ.	130 °
Forward Voltage <sup>3)</sup> $I_F = 350 \text{ mA}$	$V_F$	min. typ. max.	2.70 V 2.95 V 3.20 V
Reverse current <sup>2)</sup>	$I_R$		Not designed for reverse operation
Electrical thermal resistance junction/solderpoint with efficiency $\eta_e = 46 \%$	$R_{thJS \text{ elec.}}$	typ.	5.0 K / W

## Brightness Groups

Group	Luminous Flux <sup>1)</sup> $I_F = 350 \text{ mA}$ min. $\Phi_V$	Luminous Flux <sup>1)</sup> $I_F = 350 \text{ mA}$ max. $\Phi_V$
LU	164 lm	180 lm
MP	180 lm	194 lm
MQ	194 lm	210 lm
MR	210 lm	224 lm
MS	224 lm	240 lm
MT	240 lm	259 lm
MU	259 lm	280 lm

## Forward Voltage Groups

Group	Forward Voltage <sup>3)</sup> $I_F = 350 \text{ mA}$ min. $V_F$	Forward Voltage <sup>3)</sup> $I_F = 350 \text{ mA}$ max. $V_F$
K2	2.70 V	2.80 V
L1	2.80 V	2.90 V
L2	2.90 V	3.00 V
M1	3.00 V	3.10 V
M2	3.10 V	3.20 V

## Chromaticity Coordinate Groups 4)

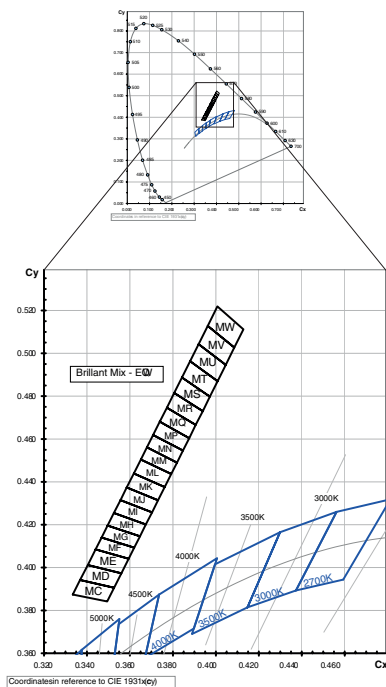

**Chromaticity Coordinate Groups** <sup>4)</sup>

Group	Cx	Cy	Group	Cx	Cy	Group	Cx	Cy
MC	0.3494	0.3842	MJ	0.3703	0.4258	MR	0.3906	0.4666
	0.3526	0.3906		0.3731	0.4314		0.3939	0.4730
	0.3368	0.3942		0.3585	0.4374		0.3806	0.4815
	0.3334	0.3874		0.3556	0.4315		0.3772	0.4746
MD	0.3526	0.3906	MK	0.3731	0.4314	MS	0.3939	0.4730
	0.3560	0.3973		0.3762	0.4376		0.3972	0.4798
	0.3404	0.4012		0.3618	0.4439		0.3842	0.4887
	0.3368	0.3942		0.3585	0.4374		0.3806	0.4815
ME	0.3560	0.3973	ML	0.3762	0.4376	MT	0.3972	0.4798
	0.3594	0.4041		0.3792	0.4437		0.4008	0.4870
	0.3440	0.4085		0.3651	0.4504		0.3880	0.4963
	0.3404	0.4012		0.3618	0.4439		0.3842	0.4887
MF	0.3594	0.4041	MM	0.3792	0.4437	MU	0.4008	0.4870
	0.3620	0.4093		0.3819	0.4490		0.4046	0.4946
	0.3468	0.4140		0.3679	0.4561		0.3920	0.5043
	0.3440	0.4085		0.3651	0.4504		0.3880	0.4963
MG	0.3620	0.4093	MN	0.3819	0.4490	MV	0.4046	0.4946
	0.3647	0.4146		0.3847	0.4546		0.4086	0.5027
	0.3496	0.4196		0.3708	0.4619		0.3962	0.5128
	0.3468	0.4140		0.3679	0.4561		0.3920	0.5043
MH	0.3647	0.4146	MP	0.3847	0.4546	MW	0.4086	0.5027
	0.3674	0.4201		0.3876	0.4604		0.4128	0.5112
	0.3525	0.4255		0.3739	0.4681		0.4007	0.5219
	0.3496	0.4196		0.3708	0.4619		0.3962	0.5128
MI	0.3674	0.4201	MQ	0.3876	0.4604			
	0.3703	0.4258		0.3906	0.4666			
	0.3556	0.4315		0.3772	0.4746			
	0.3525	0.4255		0.3739	0.4681			

---

## Group Name on Label

**Example: LU-MC-K2**

Brightness

Color Chromaticity

Forward Voltage

---

LU

MC

K2

---



### Relative Spectral Emission <sup>5)</sup>

$I_{rel} = f(\lambda); I_F = 350 \text{ mA}; T_J = 25 \text{ }^\circ\text{C}$

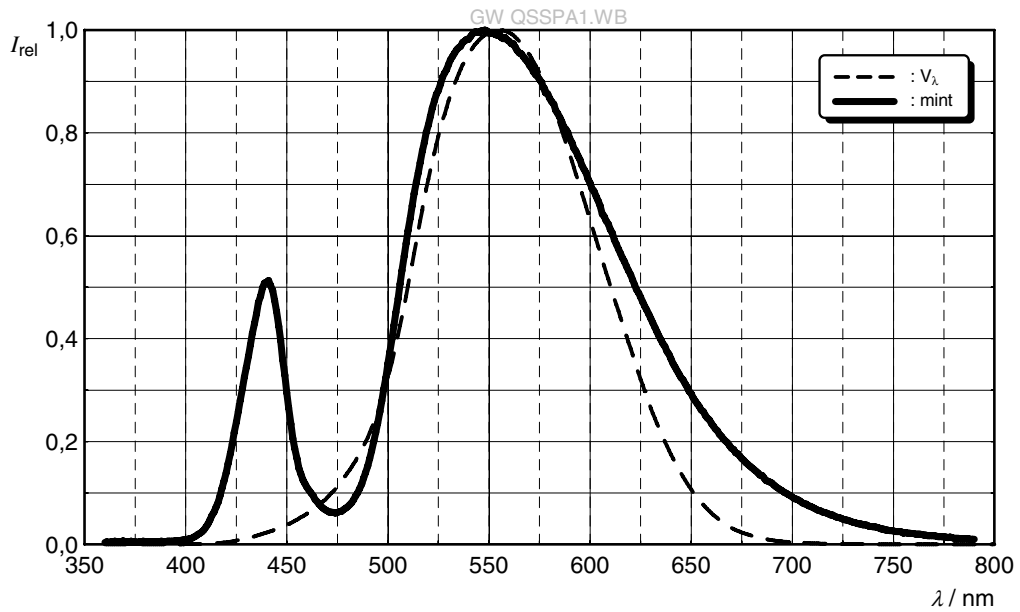

### Radiation Characteristics <sup>5)</sup>

$I_{rel} = f(\phi); T_J = 25 \text{ }^\circ\text{C}$

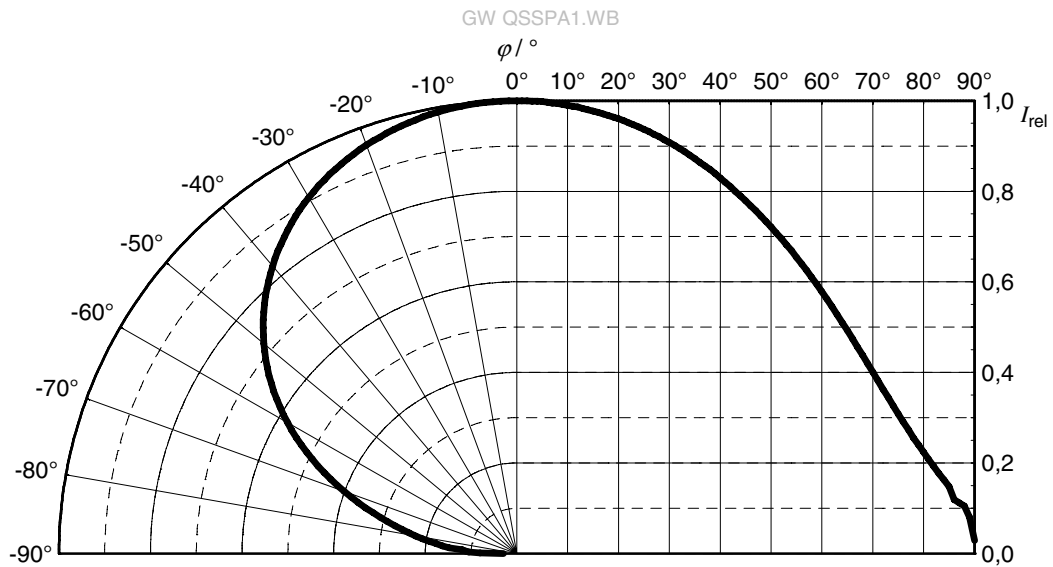

**Forward current** <sup>5)</sup>

$I_F = f(V_F); T_J = 25\text{ °C}$

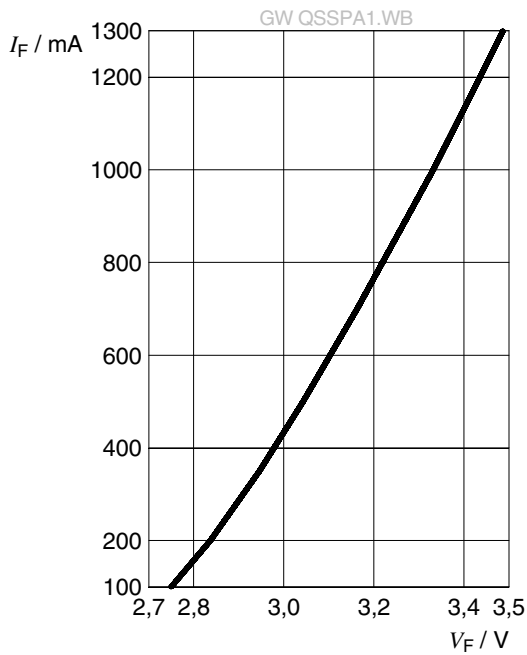

**Relative Luminous Flux** <sup>5), 6)</sup>

$\Phi_V / \Phi_V(350\text{ mA}) = f(I_F); T_J = 25\text{ °C}$

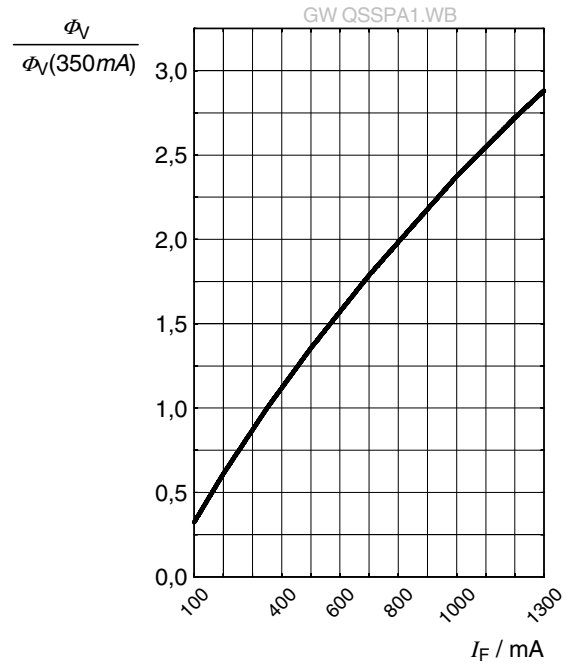

**Chromaticity Coordinate Shift** <sup>5)</sup>

$\Delta C_x, \Delta C_y = f(I_F); T_J = 25\text{ °C}$

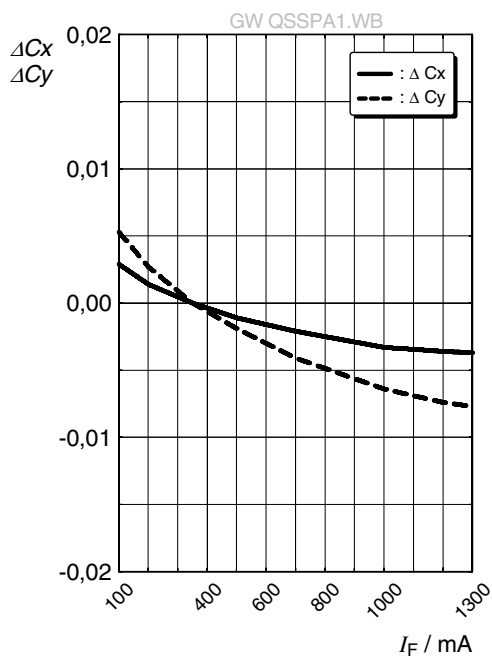

### Forward Voltage <sup>5)</sup>

$$\Delta V_F = V_F - V_F(25\text{ }^\circ\text{C}) = f(T_j); I_F = 350\text{ mA}$$

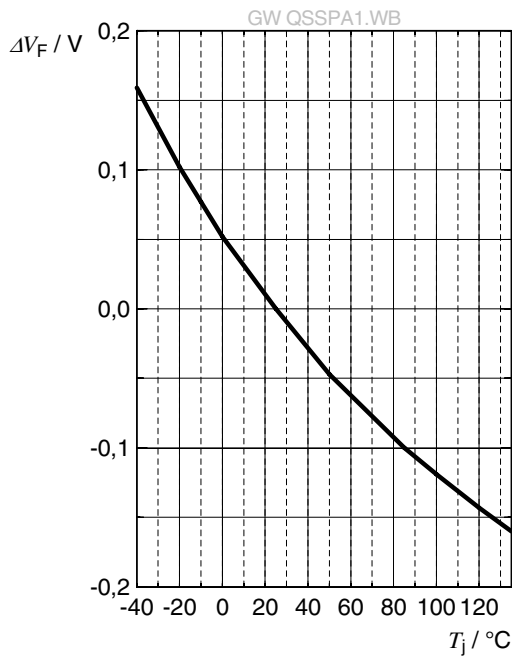

### Relative Luminous Flux <sup>5)</sup>

$$\Phi_V / \Phi_V(25\text{ }^\circ\text{C}) = f(T_j); I_F = 350\text{ mA}$$

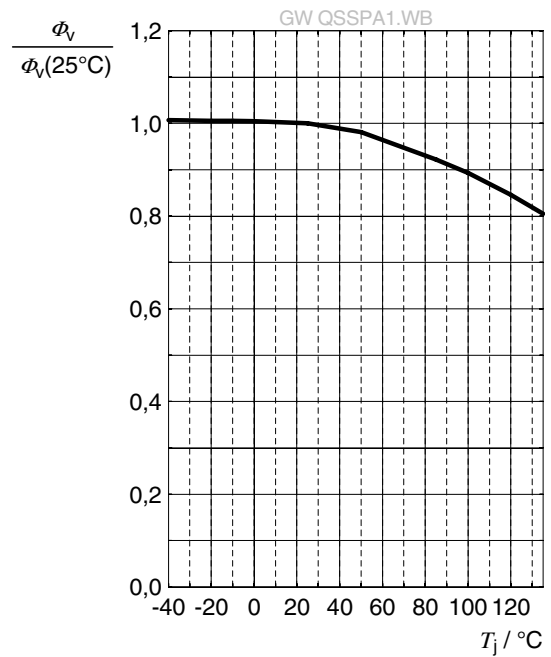

### Chromaticity Coordinate Shift <sup>5)</sup>

$$\Delta C_x, \Delta C_y = f(T_j); I_F = 350\text{ mA}$$

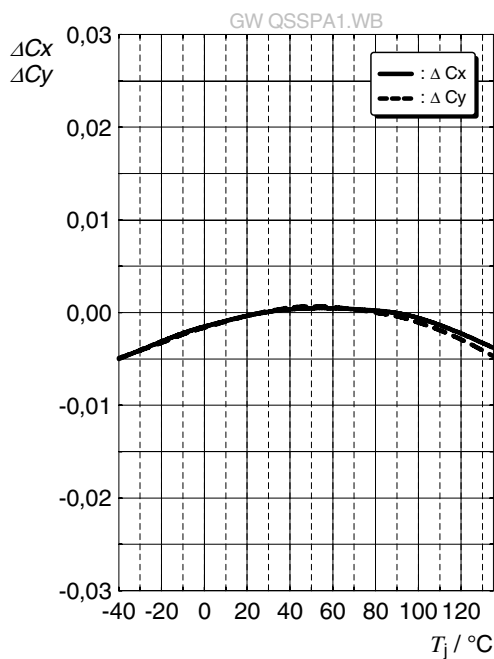

## Max. Permissible Forward Current

$$I_F = f(T)$$

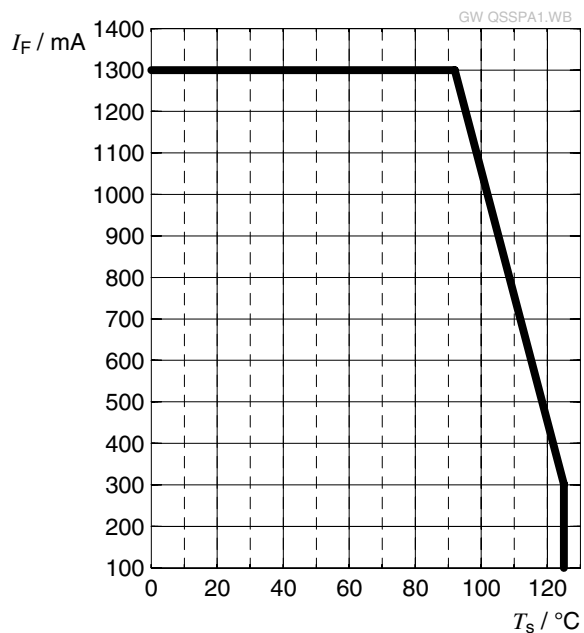

## Dimensional Drawing <sup>7)</sup>

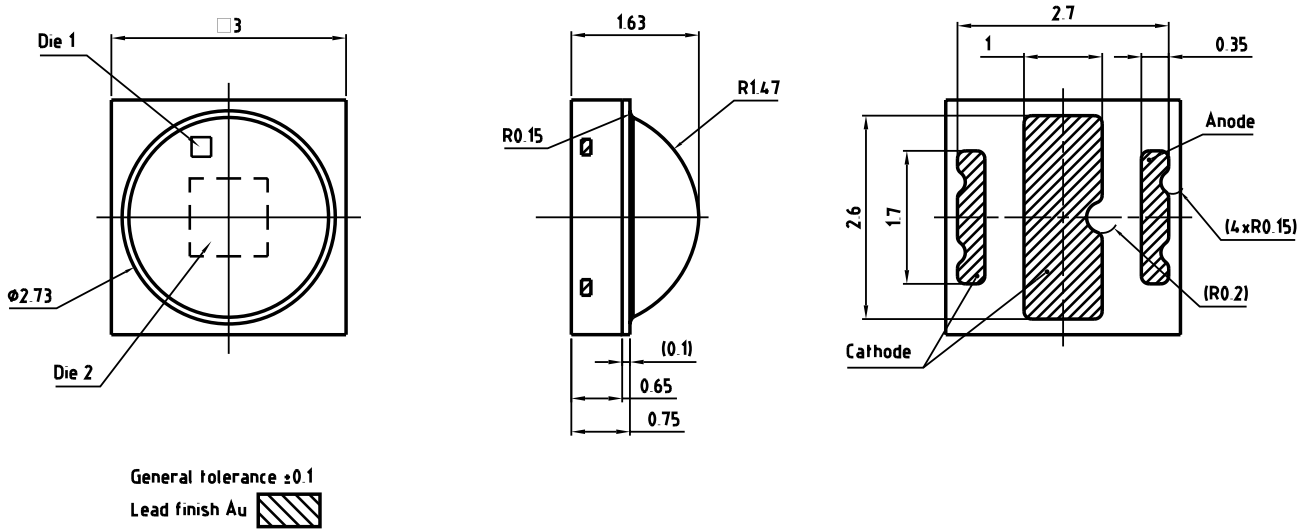

C67062-A0282-A1..-07

### Further Information:

**Approximate Weight:** 24.0 mg

**Package marking:** Anode

**Corrosion test:** Class: 3B  
 Test condition: 40°C / 90 % RH / 15 ppm H<sub>2</sub>S / 14 days (stricter than IEC 60068-2-43)

**ESD advice:** The device is protected by ESD device which is connected in parallel to the Chip.

Recommended Solder Pad 7)

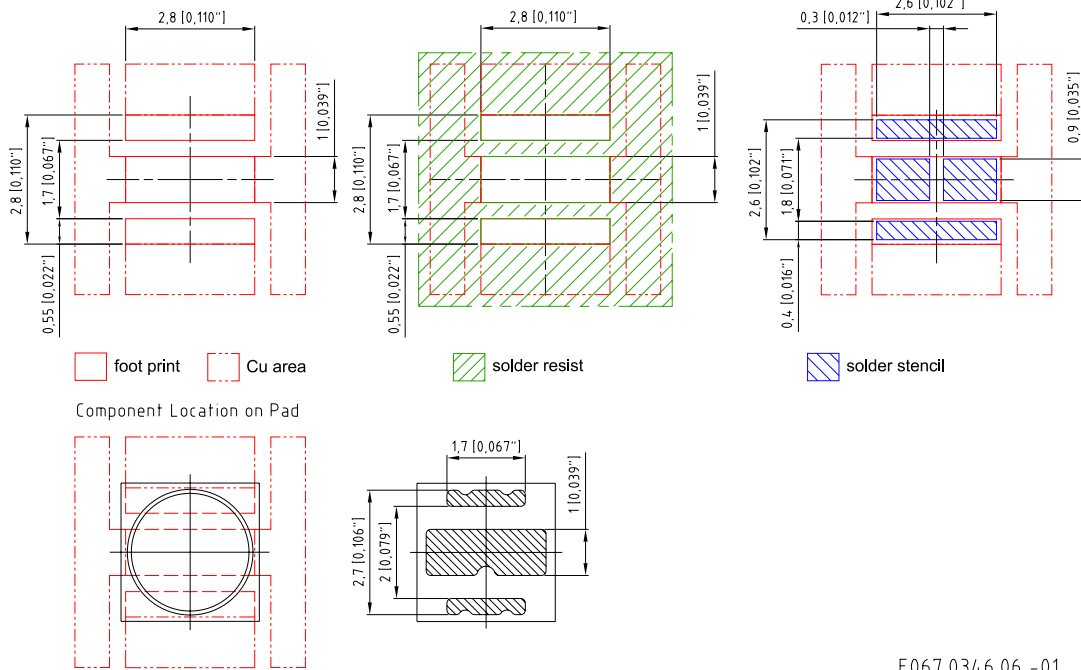

E067.0346.06 -01

For superior solder joint connectivity results we recommend soldering under standard nitrogen atmosphere. Package not suitable for ultra sonic cleaning.

## Reflow Soldering Profile

Product complies to MSL Level 2 acc. to JEDEC J-STD-020E

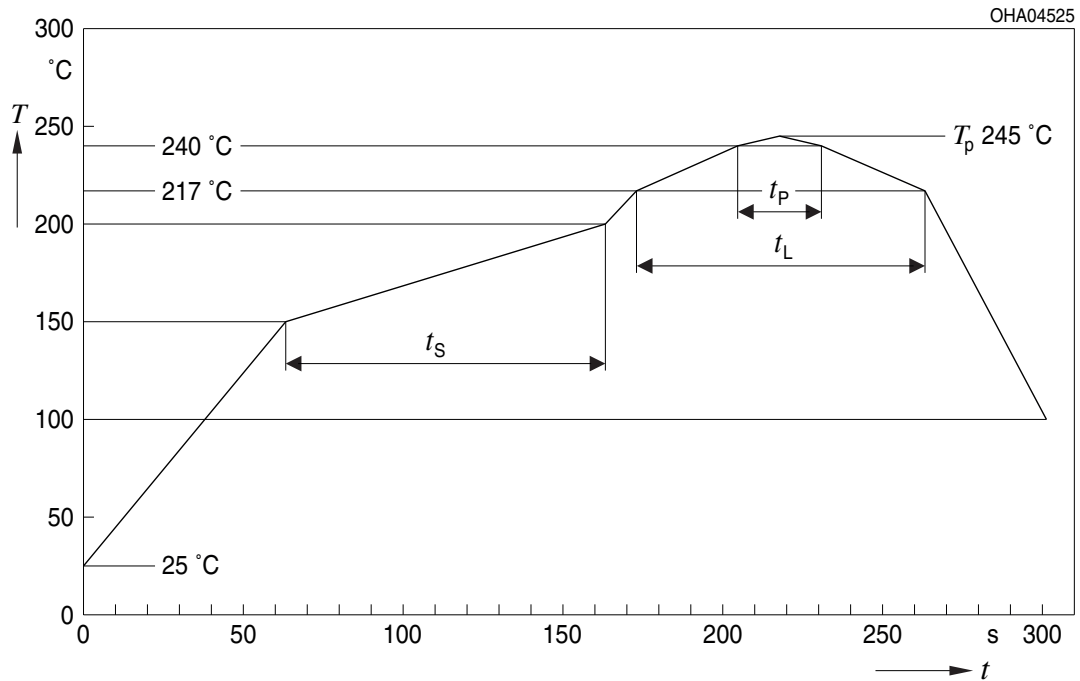

Profile Feature	Symbol	Pb-Free (SnAgCu) Assembly			Unit
		Minimum	Recommendation	Maximum	
Ramp-up rate to preheat <sup>*)</sup> 25 °C to 150 °C			2	3	K/s
Time $t_s$ $T_{Smin}$ to $T_{Smax}$	$t_s$	60	100	120	s
Ramp-up rate to peak <sup>*)</sup> $T_{Smax}$ to $T_p$			2	3	K/s
Liquidus temperature	$T_L$		217		°C
Time above liquidus temperature	$t_L$		80	100	s
Peak temperature	$T_p$		245	260	°C
Time within 5 °C of the specified peak temperature $T_p - 5$ K	$t_p$	10	20	30	s
Ramp-down rate* $T_p$ to 100 °C			3	6	K/s
Time 25 °C to $T_p$				480	s

All temperatures refer to the center of the package, measured on the top of the component  
 \*) slope calculation  $DT/Dt$ :  $Dt$  max. 5 s; fulfillment for the whole T-range

Taping <sup>7)</sup>

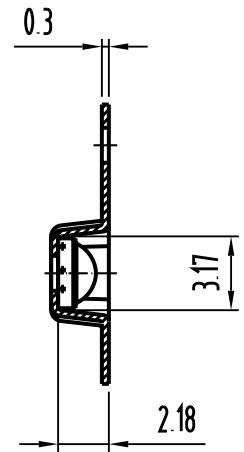
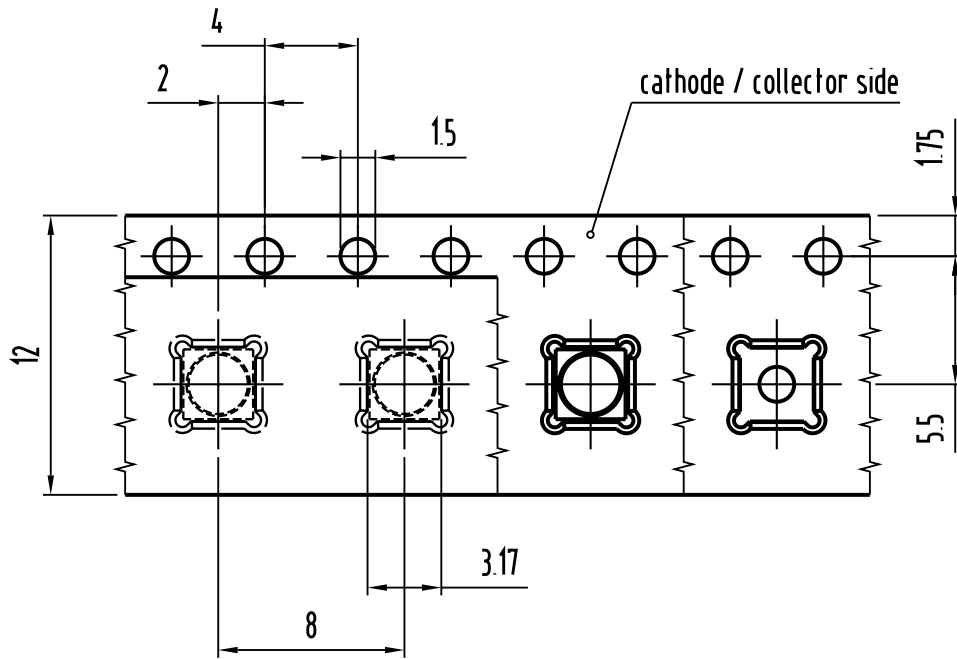

C67062-A0282-B7 05



**Tape and Reel** <sup>8)</sup>



**Reel Dimensions**

A	W	N <sub>min</sub>	W <sub>1</sub>	W <sub>2max</sub>	Pieces per PU
180 mm	12 + 0.3 / - 0.1 mm	60 mm	12.4 + 2 mm	18.4 mm	600

### Barcode-Product-Label (BPL)

**OSRAM Opto Semiconductors** LX XXXX    BIN1: XX-XX-X-XXX-X

RoHS Compliant

(6P) BATCH NO: 1234567890 ML Temp    ST  
X    XXX °C X

(1T) LOT NO: 1234567890 (9D) D/C: 1234

(X) PROD NO: 123456789(Q)QTY: 9999 (G) GROUP: XX-XX-X-X

Pack: RXX  
DEMY    XXX  
X\_X123\_1234.1234 X

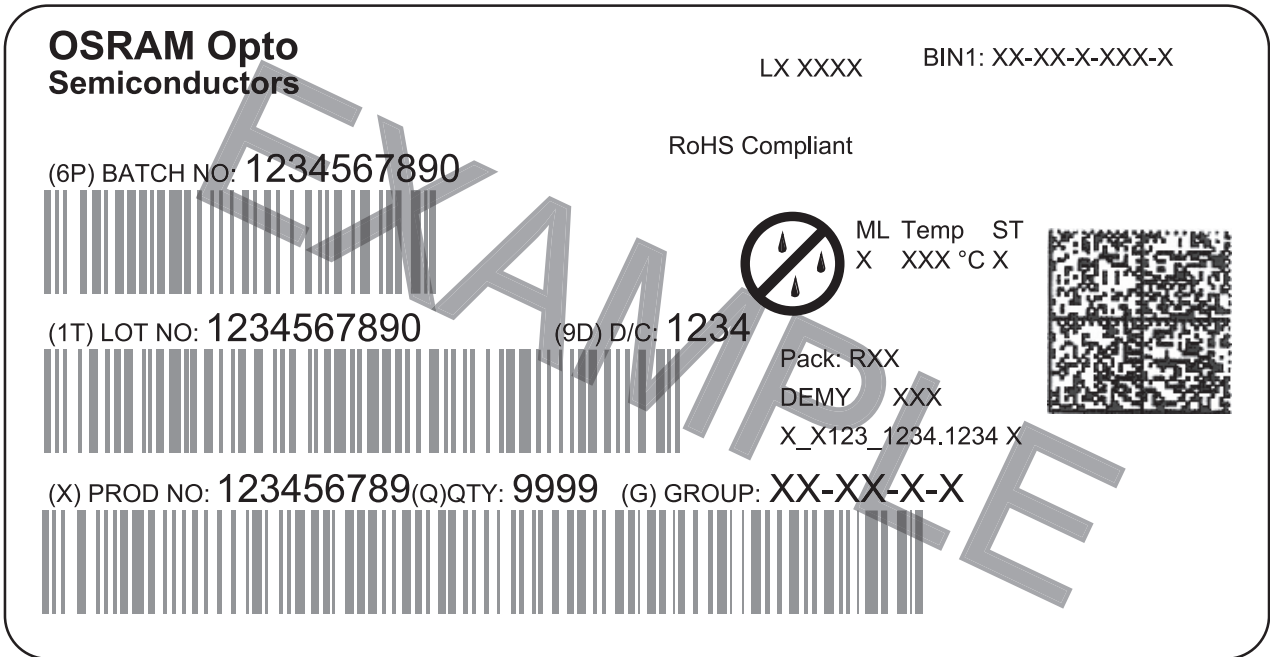

OHA04563

### Dry Packing Process and Materials <sup>7)</sup>

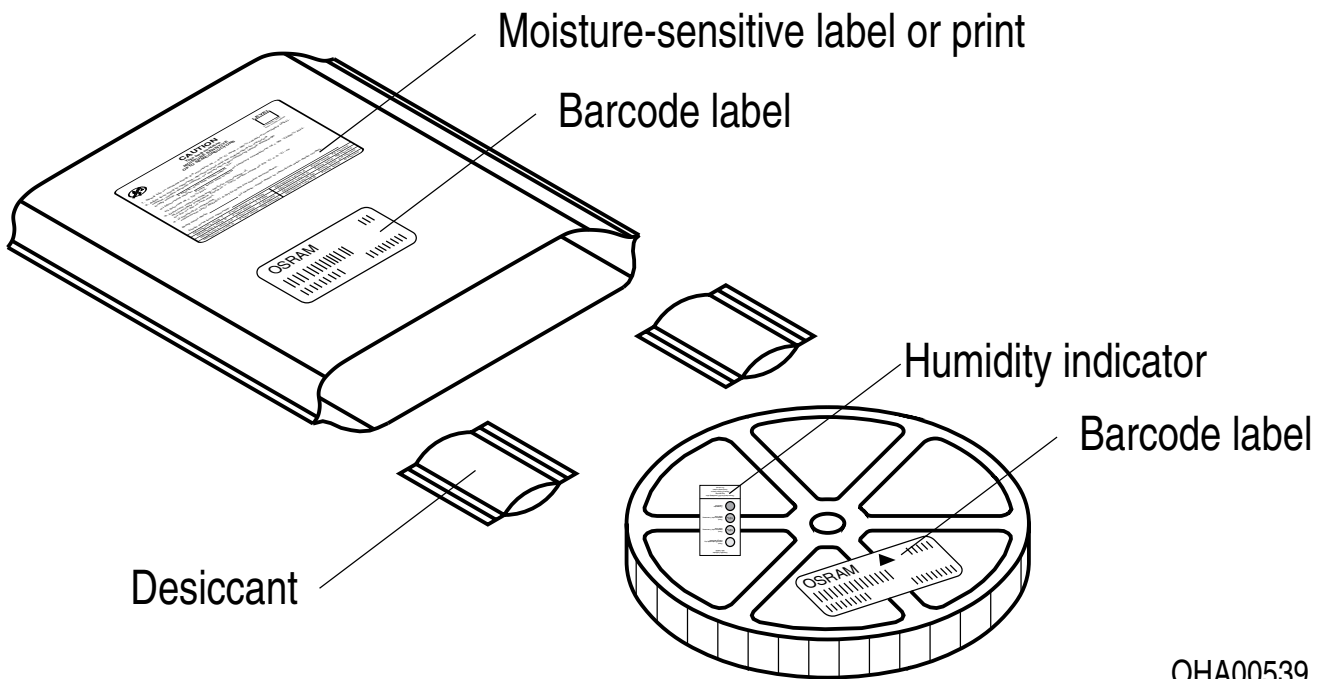

OHA00539

Moisture-sensitive product is packed in a dry bag containing desiccant and a humidity card according JEDEC-STD-033.

## Notes

The evaluation of eye safety occurs according to the standard IEC 62471:2006 (photo biological safety of lamps and lamp systems). Within the risk grouping system of this IEC standard, the device specified in this data sheet falls into the class **exempt group (exposure time 10000 s)**. Under real circumstances (for exposure time, conditions of the eye pupils, observation distance), it is assumed that no endangerment to the eye exists from these devices. As a matter of principle, however, it should be mentioned that intense light sources have a high secondary exposure potential due to their blinding effect. When looking at bright light sources (e.g. headlights), temporary reduction in visual acuity and afterimages can occur, leading to irritation, annoyance, visual impairment, and even accidents, depending on the situation.

Subcomponents of this device contain, in addition to other substances, metal filled materials including silver. Metal filled materials can be affected by environments that contain traces of aggressive substances. Therefore, we recommend that customers minimize device exposure to aggressive substances during storage, production, and use. Devices that showed visible discoloration when tested using the described tests above did show no performance deviations within failure limits during the stated test duration. Respective failure limits are described in the IEC60810.

This device is designed for specific/recommended applications only. Please consult OSRAM Opto Semiconductors Sales Staff in advance for detailed information on other non-recommended applications (e.g. automotive).

Change management for this component is aligned with the requirements of the lighting market.

For further application related information please visit [www.osram-os.com/appnotes](http://www.osram-os.com/appnotes)

## Disclaimer

### **Attention please!**

The information describes the type of component and shall not be considered as assured characteristics. Terms of delivery and rights to change design reserved. Due to technical requirements components may contain dangerous substances.

For information on the types in question please contact our Sales Organization.

If printed or downloaded, please find the latest version on the OSRAM OS website.

### **Packing**

Please use the recycling operators known to you. We can also help you – get in touch with your nearest sales office. By agreement we will take packing material back, if it is sorted. You must bear the costs of transport. For packing material that is returned to us unsorted or which we are not obliged to accept, we shall have to invoice you for any costs incurred.

### **Product and functional safety devices/applications or medical devices/applications**

OSRAM OS components are not developed, constructed or tested for the application as safety relevant component or for the application in medical devices.

OSRAM OS products are not qualified at module and system level for such application.

In case buyer – or customer supplied by buyer – considers using OSRAM OS components in product safety devices/applications or medical devices/applications, buyer and/or customer has to inform the local sales partner of OSRAM OS immediately and OSRAM OS and buyer and /or customer will analyze and coordinate the customer-specific request between OSRAM OS and buyer and/or customer.

## Glossary

- 1) **Brightness:** Brightness values are measured during a current pulse of typically 10 ms, with a tolerance of +/- 7%.
- 2) **Reverse Operation:** Not designed for reverse operation. Continuous reverse operation can cause migration and damage of the device.
- 3) **Forward Voltage:** The Forward voltage is measured during a current pulse duration of typically 1 ms with a tolerance of  $\pm 0.05V$ .
- 4) **Chromaticity coordinate groups:** Chromaticity coordinate groups are measured during a current pulse duration of typically 10ms with a tolerance of  $\pm 0.005$ .
- 5) **Typical Values:** Due to the special conditions of the manufacturing processes of semiconductor devices, the typical data or calculated correlations of technical parameters can only reflect statistical figures. These do not necessarily correspond to the actual parameters of each single product, which could differ from the typical data and calculated correlations or the typical characteristic line. If requested, e.g. because of technical improvements, these typ. data will be changed without any further notice.
- 6) **Characteristic curve:** In the range where the line of the graph is broken, you must expect higher differences between single devices within one packing unit.
- 7) **Tolerance of Measure:** Unless otherwise noted in drawing, tolerances are specified with  $\pm 0.1$  and dimensions are specified in mm.
- 8) **Tape and Reel:** All dimensions and tolerances are specified acc. IEC 60286-3 and specified in mm.

## Revision History

Version	Date	Change
1.0	2019-07-25	Initial Version
1.1	2020-02-20	Schematic Transportation Box Dimensions of Transportation Box
1.2	2020-11-04	Electro - Optical Characteristics (Diagrams) Reflow Soldering Profile
1.3	2020-11-23	Applications

Published by OSRAM Opto Semiconductors GmbH EU RoHS and China RoHS compliant product  
Leibnizstraße 4, D-93055 Regensburg  
www.osram-os.com © All Rights Reserved.



此产品符合欧盟 RoHS 指令的要求；  
按照中国的相关法规和标准，不含有毒有害物质或元素。