

GCJ43DR72J473KXJ1#

"#" indicates a package specification code.



< List of part numbers with package codes >
GCJ43DR72J473KXJ1L , GCJ43DR72J473KXJ1K

Shape

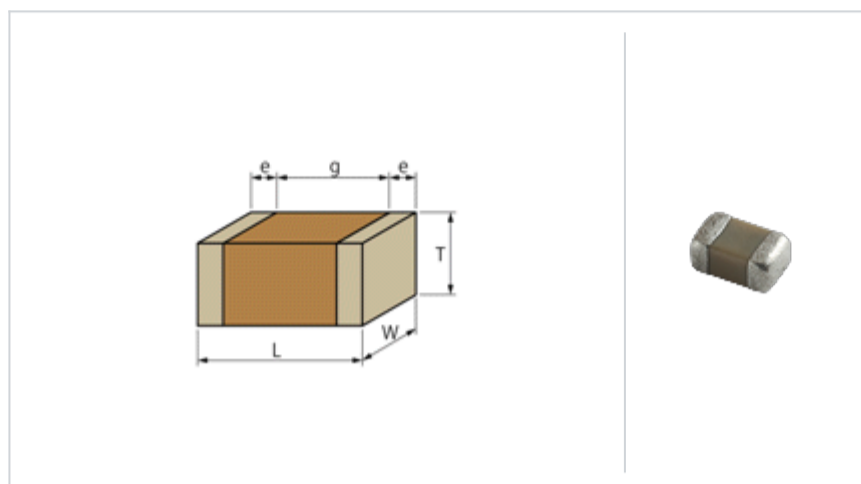

L size	4.5 ± 0.4mm
W size	3.2 ± 0.3mm
T size	2.0 +0.0/-0.3mm
External terminal width e	0.3mm min.
Distance between external terminals g	2.2mm min.
Size code in inch(mm)	1812 (4532)

Notes

Resin external electrode products

References

Packaging	Specifications	Minimum quantity
L	180mm Embossed taping	1000
K	330mm Embossed taping	4000

Mass (typ.)	
1 piece	150mg
180mm Reel	209g

Specifications

Capacitance	47000pF ± 10%
Rated voltage	630Vdc
Temperature characteristics (complied standard)	X7R(EIA)
Capacitance change rate	± 15.0%
Temperature range of temperature characteristics	-55 to 125
Operating temperature range	-55 to 125

⚠ Attention

- 1.This datasheet is downloaded from the website of Murata Manufacturing Co., Ltd. Therefore, it ' s specifications are subject to change or our products in it may be discontinued without advance notice. Please check with our sales representatives or product engineers before ordering.
- 2.This datasheet has only typical specifications because there is no space for detailed specifications. Therefore, please review our product specifications or consult the approval sheet for product specifications before ordering.

▪ Frequency characteristics (ESR, Impedance)

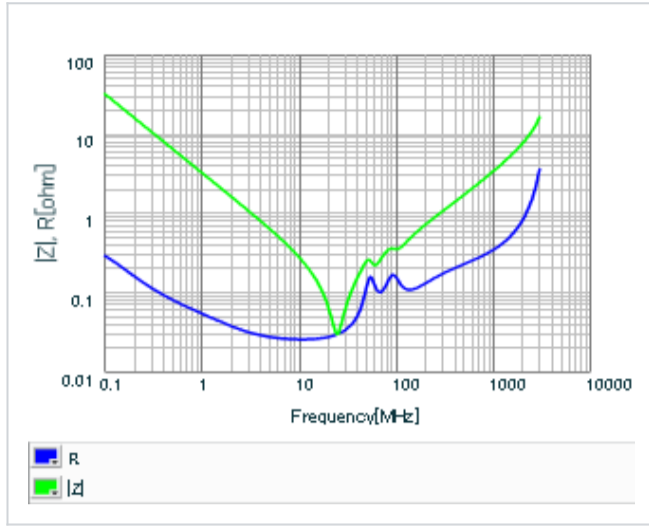

▪ S parameter (Smith chart S11)

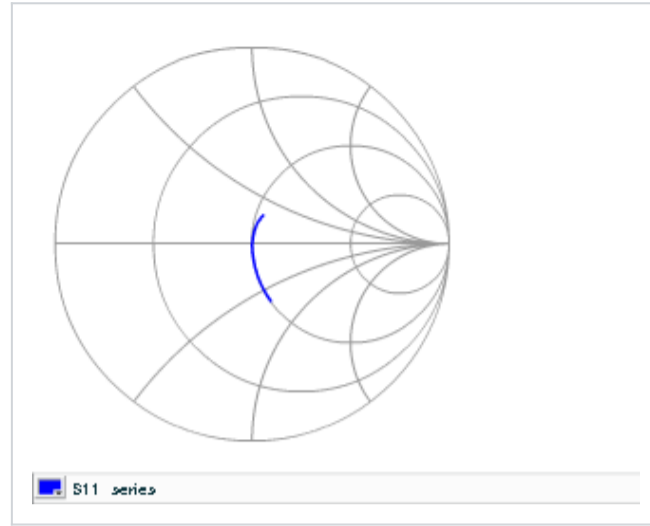

▪ DC bias characteristics

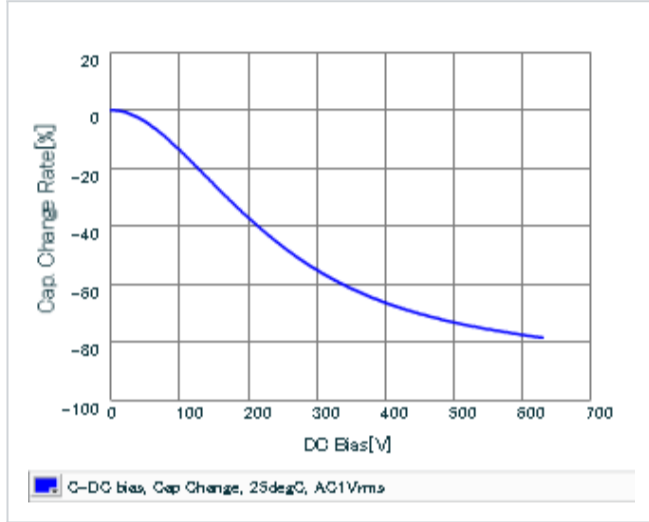

▪ AC voltage characteristics

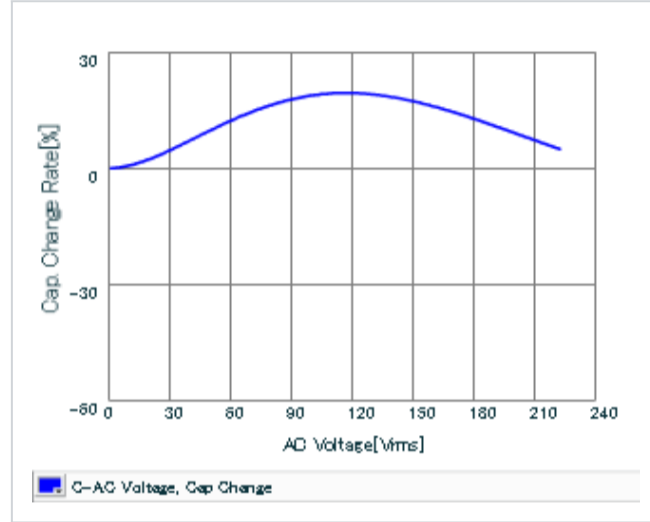

▪ Capacitance - temperature characteristics

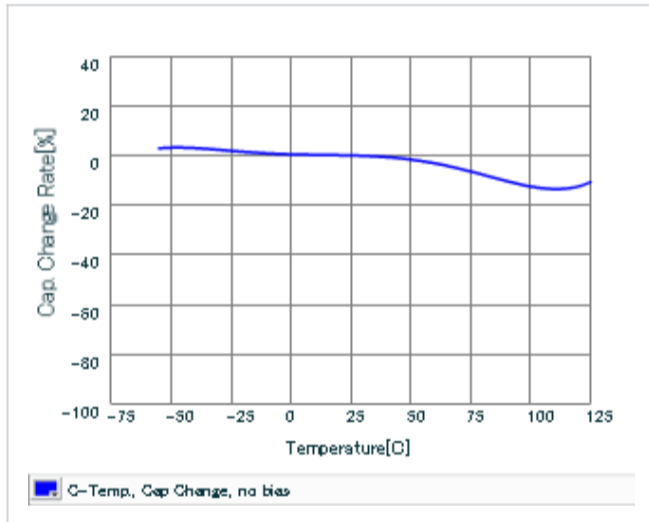

▪ Calorific property by ripple current

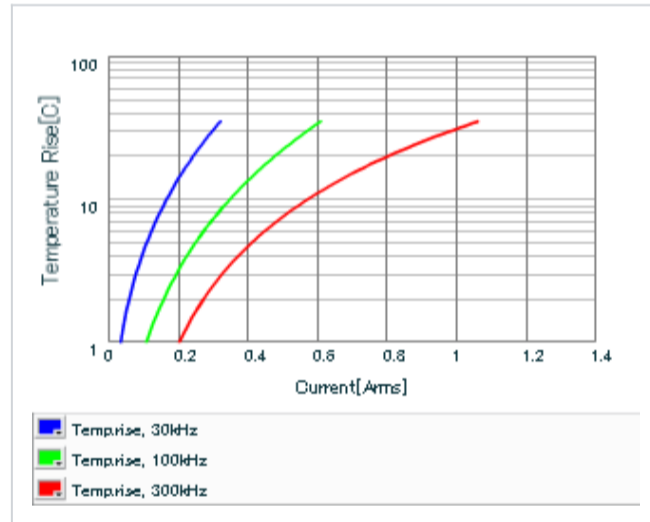

This PDF data has only typical specifications because there is no space for detailed specifications. Therefore, please review our product specifications or consult the approval sheet for product specifications before ordering.