

RECOMMENDED PCB LAYOUT - COMPONENT VIEW

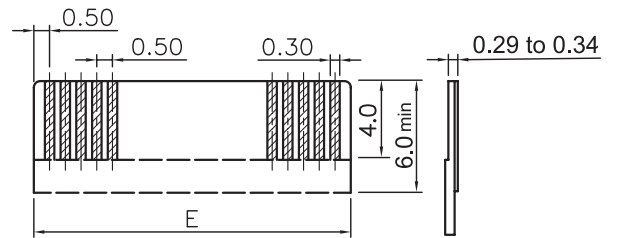

APPLICABLE FFC LAYOUT

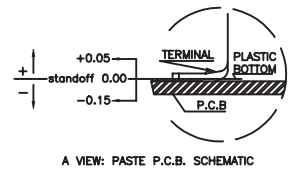
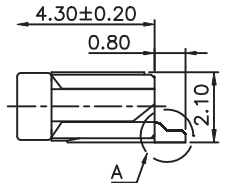
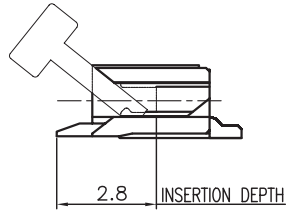

MATERIAL:
 HOUSING MATERIAL: LCP
 COLOR: IVORY
 ACTUATOR MATERIAL: LCP
 COLOR: BLACK
 CONTACT MATERIAL: PHOSPOR BRONZE
 CONTACT PLATING: 100µ" TIN OVER 50µ" NI
 QUALITY CLASS: 25 MATING CYCLES*

ENVIRONMENTAL:
 OPERATING TEMPERATURE: -25°C UP TO 85°C
 FLAMABILITY RATING: UL94-V0
 COMPLIANCE: LEAD FREE AND ROHS

ELECTRICAL:
 CURRENT RATING: 0.5A
 WORKING VOLTAGE: 50V
 INSULATION RESISTANCE: >100MOHM
 DIELECTRIC WITHSTANDING VOLT.: 250VAC/MN
 CONTACT RESISTANCE: 20mOHM MAX

STANDARD
 CERTIFIED: E323964
 FOLLOWED BY 1, FOLLOWED BY 04 THRU 50, FOLLOWED
 BY 140 OR 145, FOLLOWED BY NUMERIC DIGITS



SOLDERING:
 REFLOW PROCESS ONLY

DIMENSION:
 B = 0.5 x NB PINS + 6.4
 C = 0.5 x (NB PINS - 1)
 D = 0.5 x (NB PINS + 1) + 0.1
 E = 0.5 x (NB PINS + 1)

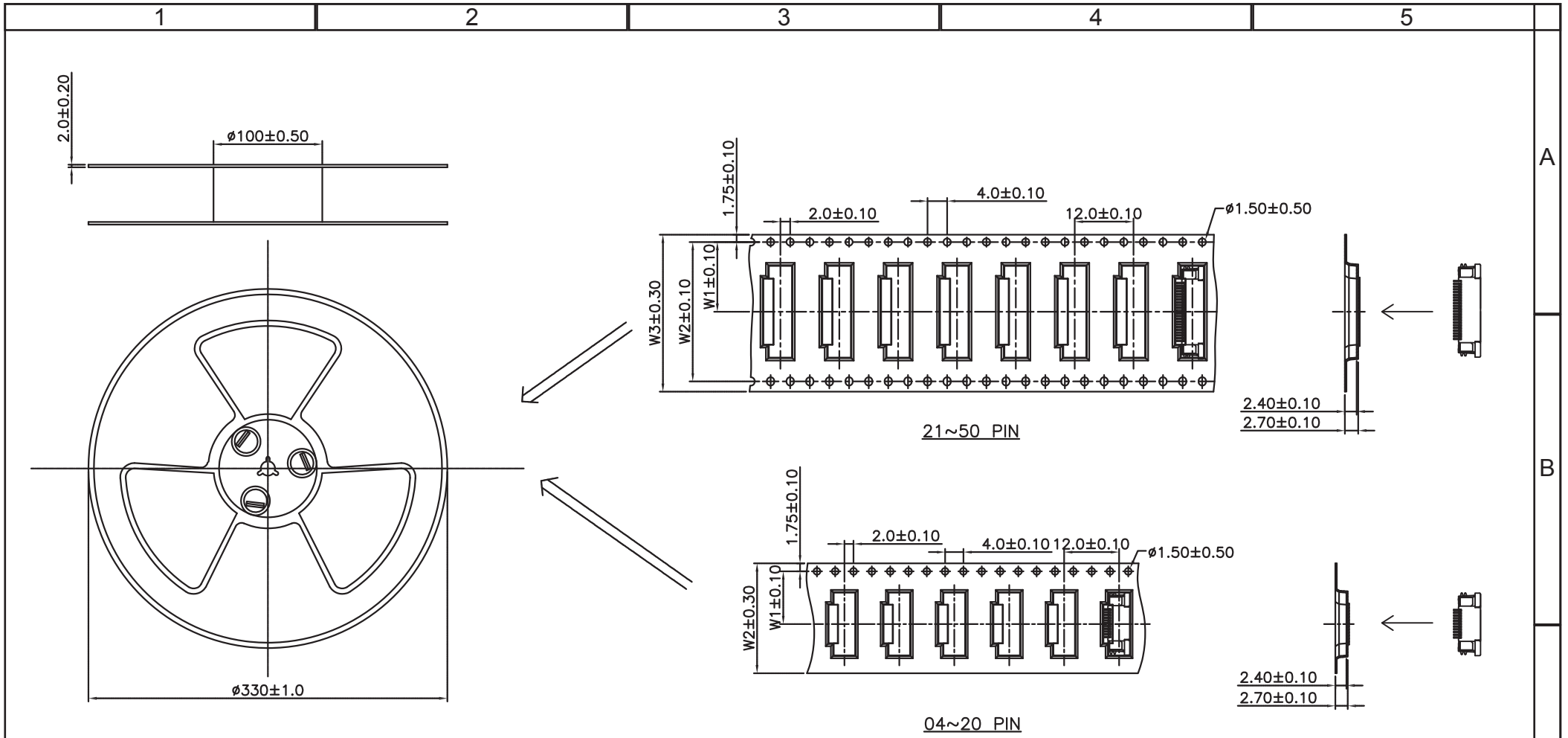
RoHS Compliant		*NOTE: theoretical value related to the Tin plating; however, due to the sensitive actuator, we recommend not to make more than 1 or 2 cycles in order to maintain acceptable mechanical & electrical conditions					
				PROJECTION:	GENERAL TOLERANCE		
					.X = +/- 0.2 .XX = +/- 0.15		
K	25-JAN-16	TPK UPDATE	AK	APPROVAL: GMo			
J	01-JUN-15	TPK UPDATE	QL				
I	13-DEC-13	TPK UPDATE	QL				
H	23-JAN-13	UNIT µ => µ"	QL				
REV	DATE	FILE	BY				
					UNIT: MM	DESCRIPTION: 0.5MM ZIF FPC HORIZONTAL BOTTOM CONTACT TYPE - TAPE & REEL PACKAGING	SIZE A4
					SCALE:		
					SHEET: 1/3	WERI PART NO: 6871 xx 14522	
					DRAW: QL		

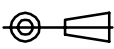

NOTE: 1. 04~06PIN: DIM W1:7.5mm W2:16.0mm PH:12mm
 07~20PIN: DIM W1:11.5mm W2:24.0mm PH:12mm
 21~30PIN: DIM W1:14.2mm W2:28.4mm W3:32.0mm PH:12mm
 31~50PIN: DIM W1:20.2mm W2:40.4mm W3:44.0mm PH:12mm
 2. 2000PCS/REEL

RoHS Compliant				PROJECTION: 	GENERAL TOLERANCE .X = ± 0.2 .XX = ± 0.15		DESCRIPTION: 0.5MM ZIF FPC HORIZONTAL BOTTOM CONTACT TYPE - TAPE & REEL PACKAGING WERI PART NO: 6871 xx 14522	SIZE A4
G								
F								
E								
D								
C				APPROVAL: Gm0	UNIT: MM			
B					SCALE:			
A					SHEET: 2/3			
REV	DATE	FILE	BY		DRAW: QL			

1

2

3

4

5

Cautions and Warnings:

This electronic component is designed and developed with the intention for use in general electronics equipments.

Before incorporating the components into any equipments in the field such as aerospace, aviation, nuclear control, submarine, transportation, (automotive control, train control, ship control), transportation signal, disaster prevention, medical, public information network etc. where higher safety and reliability are especially required or if there is possibility of direct damage or injury to human body, Würth Elektronik must be asked for a written approval.

In addition, even electronic component in general electronic equipments, when used in electrical circuits that require high safety, reliability functions or performance, the sufficient reliability evaluation-check for the safety must be performed before by the user before usage.

A

B

C

RoHS Compliant

G				PROJECTION: 	GENERAL TOLERANCE .X = +/- 0.2 .XX = +/- 0.15		
F							
E							
D							
C				APPROVAL: JC	UNIT: MM	DESCRIPTION: DISCLAIMER	SIZE A4
B					SCALE:		
A	10-SEP-14	PDF	QL		SHEET: 3/3	WERI PART NO: DISCLAIMER	
REV	DATE	FILE	BY		DRAW: QL		

D

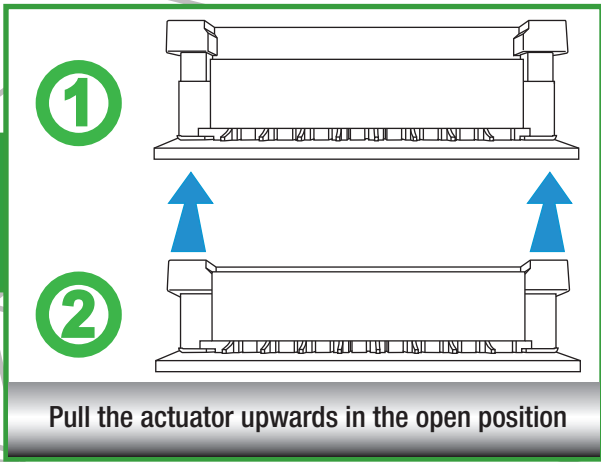

A

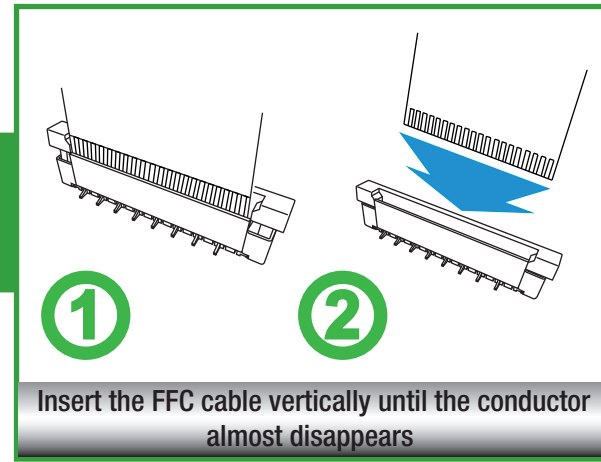

B

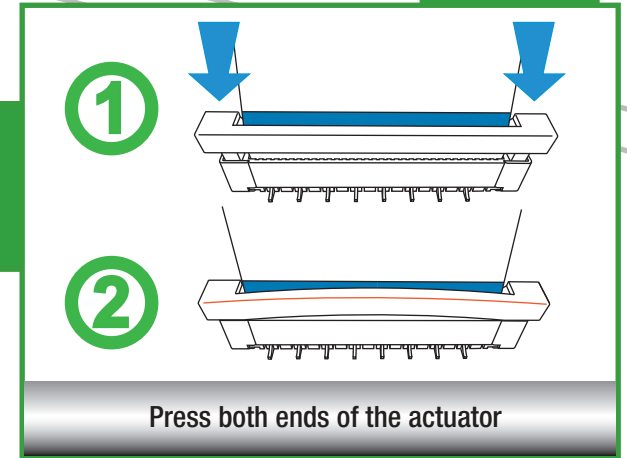
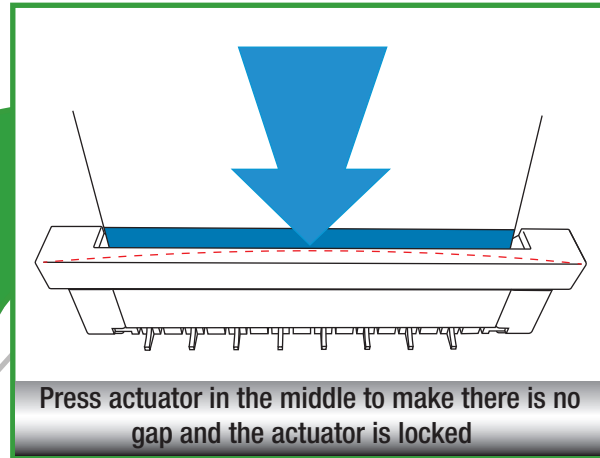

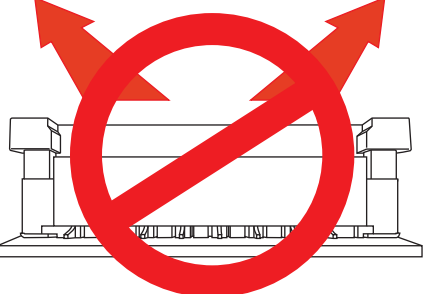

Pull the actuator as horizontally as possible by a proper force

A

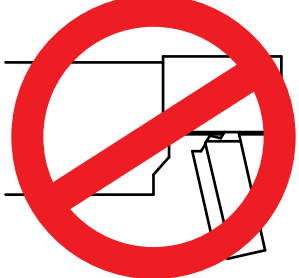

Do not pull the actuator too far otherwise the stop limit (hook on actuator) may be broken

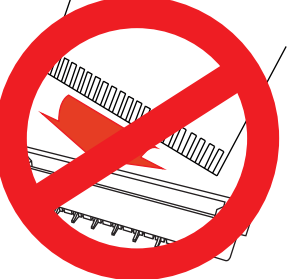

Do not keep FFC inclined when insertion

B

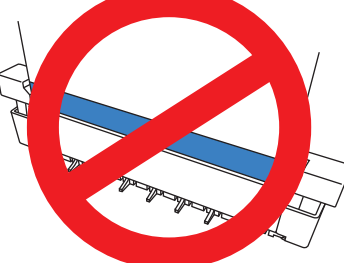

Don't keep conductor toward actuator