



General Description:

Using CRM's proprietary trench design, advanced FS(field stop) technology and integrated with Free Wheeling Diode, the 1200V Trench FS IGBT offers superior conduction and switching performances, high avalanche ruggedness.

Features:

- Trench FS Technology, Positive temperature coefficient
- Low saturation voltage: $V_{CE(sat)}$, typ =1.95V
@ $I_C = 15A$
- Extremely enhanced avalanche capability

Applications:

Power switch circuit of induction cooker(IH).

V_{CES}	1200	V
I_C	15	A
$P_{tot}(T_C=25^\circ C)$	156	W
$V_{CE(SAT)}$	1.95	V

TO-3P (N)

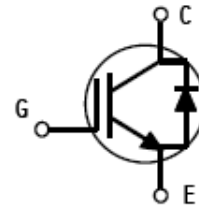

Ordering Information:

Part Number	Package	Marking	Delivery mode
CRG15T120BNR3S	TO-3P(N)	G15T120BNR3S	Tube

Absolute Maximum Ratings

($T_j = 25^\circ C$ unless otherwise specified):

Symbol	Parameter	Rating	Units
V_{CES}	Collector-Emitter Voltage	1200	V
V_{GES}	Gate- Emitter Voltage	± 20	V
I_C	Collector Current@ $T_C = 25^\circ C$	30	A
	Collector Current @ $T_C = 100^\circ C$	15	A
I_{CM}^{al}	Pulsed Collector Current@ $T_C = 25^\circ C$	45	A
I_F	Diode Continuous Forward Current @ $T_C = 100^\circ C$	15	A
I_{FM}	Diode Maximum Forward Current@ $T_C = 25^\circ C$	45	A
P_D	Power Dissipation @ $T_C = 25^\circ C$	156	W
	Power Dissipation @ $T_C = 100^\circ C$	62	W
T_J, T_{stg}	Operating Junction and Storage Temperature Range	150, -55 to +150	$^\circ C$



T_L	Maximum Temperature for Soldering	270	$^{\circ}\text{C}$
-------	-----------------------------------	-----	--------------------

^{a1}: Repetitive rating; pulse width limited by maximum junction temperature.

Thermal Characteristics

Symbol	Parameter	Typ.	Max.	Units
$R_{\theta JC}$	Thermal Resistance, Junction to case for IGBT	0.55	0.8	$^{\circ}\text{C}/\text{W}$
$R_{\theta JA}$	Thermal Resistance, Junction to Ambient	35	40	$^{\circ}\text{C}/\text{W}$

Electrical Characteristics of the IGBT ($T_j = 25^{\circ}\text{C}$ unless otherwise specified):

OFF Characteristics						
Symbol	Parameter	Test Conditions	Rating			Units
			Min.	Typ.	Max.	
V_{CES}	Collector-Emitter Breakdown Voltage	$V_{GE}=0\text{V}, I_{CE}=1\text{mA}$	1200	--	--	V
I_{CES}	Collector-Emitter Leakage Current	$V_{GE}=0\text{V}, V_{CE}=V_{CES}$	--	--	1.0	mA
$I_{GES(F)}$	Gate to Emitter Forward Leakage	$V_{GE}=+20\text{V}$	--	--	+250	nA
$I_{GES(R)}$	Gate to Source Reverse Leakage	$V_{GE}=-20\text{V}$	--	--	-250	nA

ON Characteristics						
Symbol	Parameter	Test Conditions	Rating			Units
			Min.	Typ.	Max.	
$V_{CE(sat)}$	Collector-Emitter Saturation Voltage	$I_C=15\text{A}, V_{GE}=15\text{V}$	--	1.95	2.5	V
V_{FM}	Diode Forward Voltage	$I_F=15\text{A}$	--	2.7	3.2	V
$V_{GE(TH)}$	Gate Threshold Voltage	$I_C=250\mu\text{A}, V_{CE}=V_{GE}$	4.5	5.8	7.5	V

Pulse width $t_p \leq 300 \mu\text{s}, \delta \leq 2\%$

Dynamic Characteristics						
Symbol	Parameter	Test Conditions	Rating			Units
			Min.	Typ.	Max.	
C_{ies}	Input Capacitance	$V_{CE}=25\text{V}, V_{GE}=0\text{V}$ $f=1\text{MHz}$	--	1513	--	pF
C_{oes}	Output Capacitance		--	35	--	
C_{res}	Reverse Transfer Capacitance		--	25	--	

Resistive Switching Characteristics						
Symbol	Parameter	Test Conditions	Rating			Units
			Min.	Typ.	Max.	
$t_{d(ON)}$	Turn-on Delay Time	$T_j = 25^{\circ}\text{C}$ $V_{CE}=600\text{V}, I_C=15\text{A}$ $V_{GE}=0/15\text{V},$ $R_g=10\Omega$ Inductive Load	--	14	--	ns
t_r	Rise Time		--	32	--	
$t_{d(OFF)}$	Turn-Off Delay Time		--	107	--	
t_f	Fall Time		--	131	--	mJ
E_{on}	Turn-On Switching Loss		--	0.43	--	
E_{off}	Turn-Off Switching Loss		--	0.7	--	



CRG15T120BNR3S



Ets	Total Switching Loss		--	1.13	--	
Q_g	Total Gate Charge	$V_{CE}=960V, I_C=15A$ $V_{GE}=15V$	--	81.5	--	nC
Q_{ge}	Gate to Emitter Charge		--	7.5	--	
Q_{gc}	Gate to Collector Charge		--	51.5	--	

Characteristics Cure

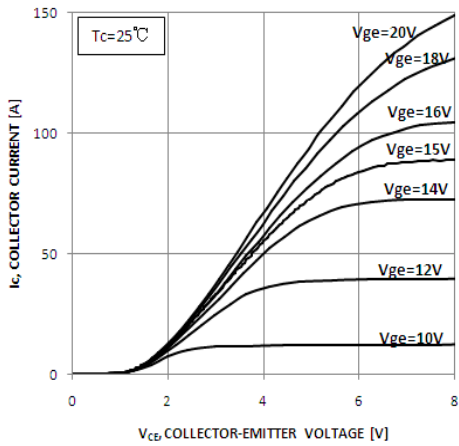

Figure 1. Typical Output Characteristics

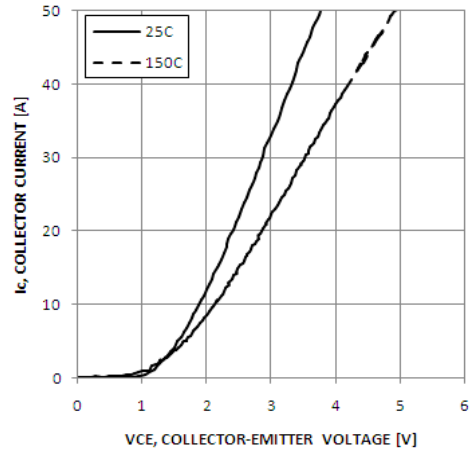

Figure 2. Typical Output Characteristics

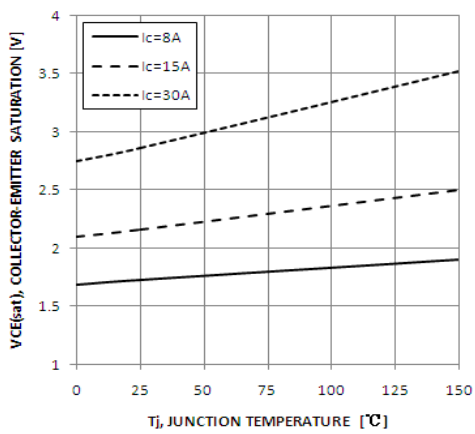

Figure 3. Typical Saturation Voltage vs. Junction Temperature

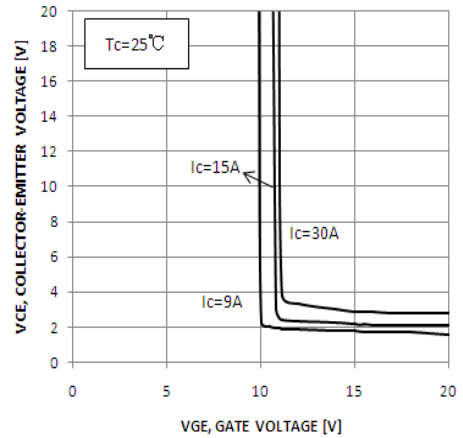

Figure 4. Typical Saturation Voltage vs. Gate- Emitter Voltage

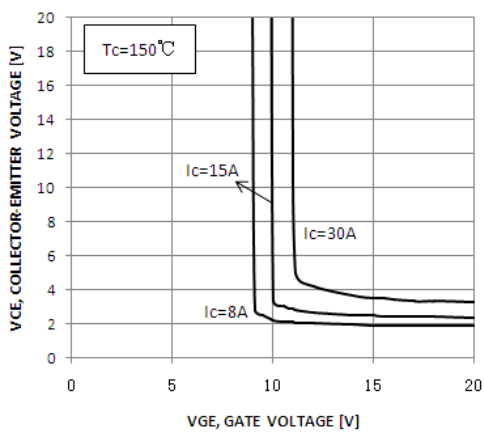

Figure 5. Typical Saturation Voltage vs. Gate-Emitter Voltage

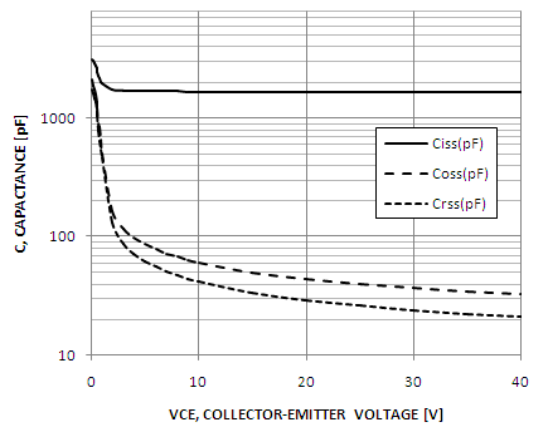

Figure 6. Typical Capacitance Characteristics

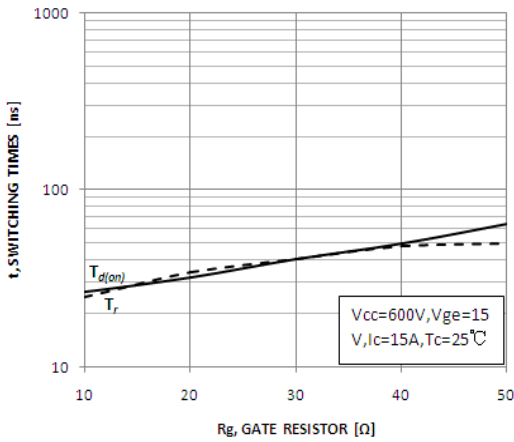

Figure 7. Typical Turn-On Characteristics vs. Gate Resistance

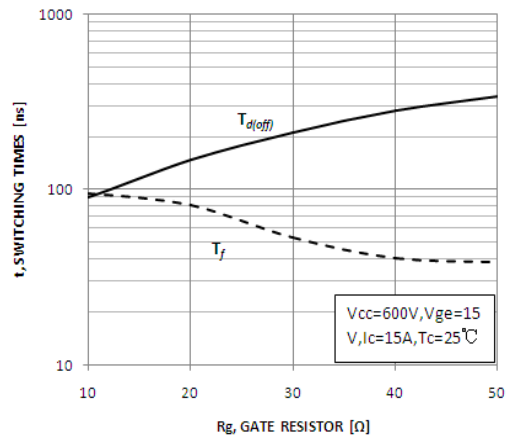

Figure 8. Typical Turn-Off Characteristics vs. Gate Resistance

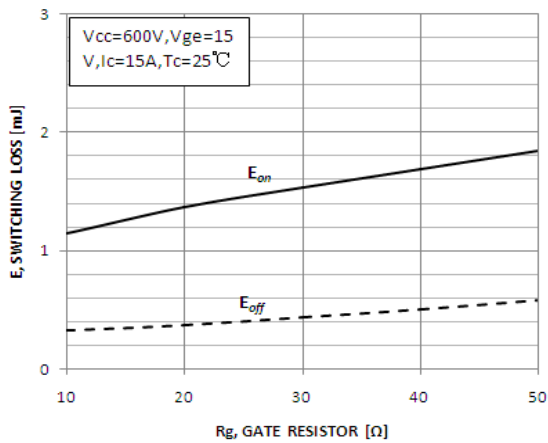

Figure 9. Typical Switching Losses vs. Gate Resistance

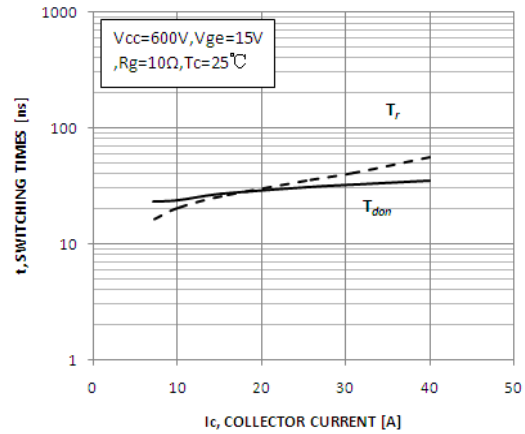

Figure 10. Typical Turn-On Characteristics vs. Collector Current

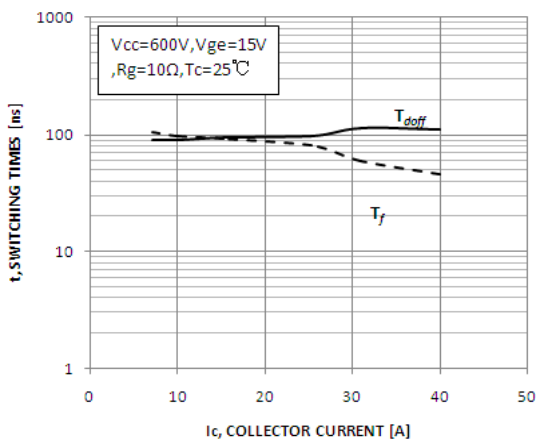

Figure 11. Typical Turn-Off Characteristics vs. Collector Current

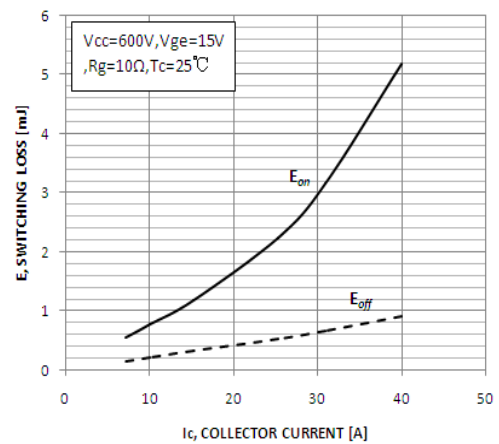

Figure 12. Typical Switching Losses vs. Collector Current

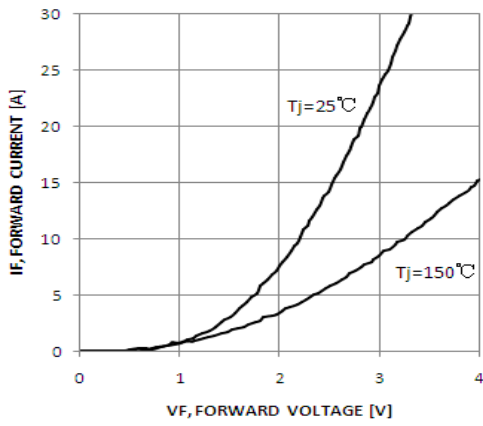

Figure 13. Typical Diode Forward Characteristics

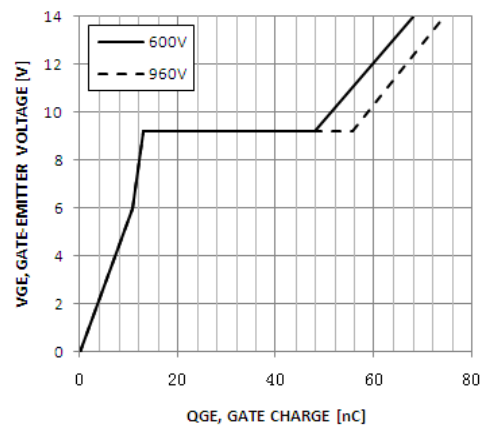

Figure 14. Typical Gate Charge

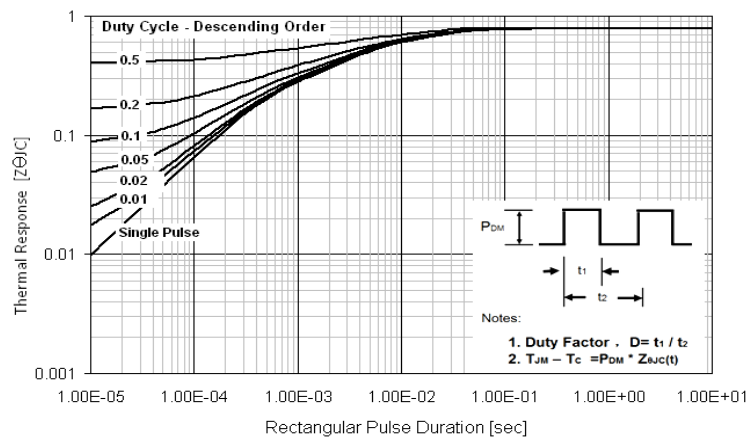
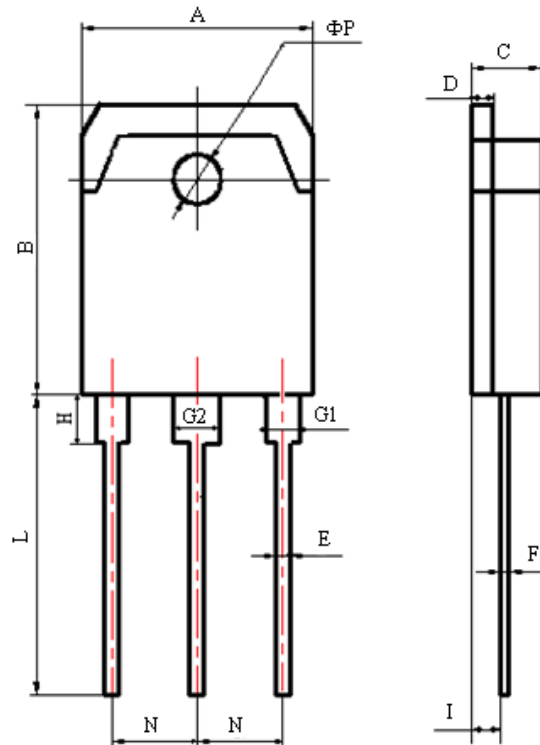

Figure 15. Transient Thermal Impedance of IGBT

Package Information

Items	Values(mm)	
	MIN	MAX
A	15.00	16.00
B	19.20	20.60
C	4.60	5.00
D	1.40	1.60
E	0.90	1.10
F	0.50	0.70
G1	2.00	2.20
G2	3.00	3.20
H	3.00	3.70
I	1.20	1.70
	2.70	2.90
L*	19.00	21.00
N	5.25	5.65
ΦP	3.10	3.30

*: adjustable

TO-3P(N) Package

**The name and content of poisonous and harmful material in products**

Part's Name	Hazardous Substance									
	Pb	Hg	Cd	Cr(VI)	PBB	PBDE	DIBP	DEHP	DBP	BBP
Limit	≤ 0.1%	≤ 0.1%	≤ 0.01%	≤0.1%	≤0.1%	≤0.1%	≤0.1%	≤0.1%	≤0.1%	≤0.1%
Lead Frame	○	○	○	○	○	○	○	○	○	○
Molding	○	○	○	○	○	○	○	○	○	○
Chip	○	○	○	○	○	○	○	○	○	○
Wire Bonding	○	○	○	○	○	○	○	○	○	○
Solder	×	○	○	○	○	○	○	○	○	○
Note	<p>○: Means the hazardous material is under the criterion of 2011/65/EU. ×: Means the hazardous material exceeds the criterion of 2011/65/EU. The plumbum element of solder exist in products presently, but within the allowed range of Eurogroup's RoHS.</p>									

Warnings

1. Exceeding the maximum ratings of the device in performance may cause damage to the device, even the permanent failure, which may affect the dependability of the machine. It is suggested to be used under 80 percent of the maximum ratings of the device.
2. When installing the heat sink, please pay attention to the torsional moment and the smoothness of the heat sink.
3. IGBTs is the device which is sensitive to the static electricity, it is necessary to protect the device from being damaged by the static electricity when using it.
4. This publication is made by Huajing Microelectronics and subject to regular change without notice.

WUXI CHINA RESOURCES HUAJING MICROELECTRONICS CO., LTD.

Add: No.14 Liangxi RD. Wuxi, Jiangsu, China **Mail:** 214061 <https://www.crmicro.com>
Tel: 0510-85807228 **Fax:** 0510-85800864

Marketing Part: **Post:** 214061 **Tel / Fax:** 0510-85807228-3663/5508
 0510-85800360 (Fax)

Application and Service: **Post:** 214061 **Tel / Fax:** 0510-85807228-3399 / 2227