



Is Now Part of



**ON Semiconductor®**

To learn more about ON Semiconductor, please visit our website at  
[www.onsemi.com](http://www.onsemi.com)

Please note: As part of the Fairchild Semiconductor integration, some of the Fairchild orderable part numbers will need to change in order to meet ON Semiconductor's system requirements. Since the ON Semiconductor product management systems do not have the ability to manage part nomenclature that utilizes an underscore (\_), the underscore (\_) in the Fairchild part numbers will be changed to a dash (-). This document may contain device numbers with an underscore (\_). Please check the ON Semiconductor website to verify the updated device numbers. The most current and up-to-date ordering information can be found at [www.onsemi.com](http://www.onsemi.com). Please email any questions regarding the system integration to [Fairchild\\_questions@onsemi.com](mailto:Fairchild_questions@onsemi.com).

ON Semiconductor and the ON Semiconductor logo are trademarks of Semiconductor Components Industries, LLC dba ON Semiconductor or its subsidiaries in the United States and/or other countries. ON Semiconductor owns the rights to a number of patents, trademarks, copyrights, trade secrets, and other intellectual property. A listing of ON Semiconductor's product/patent coverage may be accessed at [www.onsemi.com/site/pdf/Patent-Marking.pdf](http://www.onsemi.com/site/pdf/Patent-Marking.pdf). ON Semiconductor reserves the right to make changes without further notice to any products herein. ON Semiconductor makes no warranty, representation or guarantee regarding the suitability of its products for any particular purpose, nor does ON Semiconductor assume any liability arising out of the application or use of any product or circuit, and specifically disclaims any and all liability, including without limitation special, consequential or incidental damages. Buyer is responsible for its products and applications using ON Semiconductor products, including compliance with all laws, regulations and safety requirements or standards, regardless of any support or applications information provided by ON Semiconductor. "Typical" parameters which may be provided in ON Semiconductor data sheets and/or specifications can and do vary in different applications and actual performance may vary over time. All operating parameters, including "Typicals" must be validated for each customer application by customer's technical experts. ON Semiconductor does not convey any license under its patent rights nor the rights of others. ON Semiconductor products are not designed, intended, or authorized for use as a critical component in life support systems or any FDA Class 3 medical devices or medical devices with a same or similar classification in a foreign jurisdiction or any devices intended for implantation in the human body. Should Buyer purchase or use ON Semiconductor products for any such unintended or unauthorized application, Buyer shall indemnify and hold ON Semiconductor and its officers, employees, subsidiaries, affiliates, and distributors harmless against all claims, costs, damages, and expenses, and reasonable attorney fees arising out of, directly or indirectly, any claim of personal injury or death associated with such unintended or unauthorized use, even if such claim alleges that ON Semiconductor was negligent regarding the design or manufacture of the part. ON Semiconductor is an Equal Opportunity/Affirmative Action Employer. This literature is subject to all applicable copyright laws and is not for resale in any manner.

# FDC8602

## Dual N-Channel Shielded Gate PowerTrench® MOSFET 100 V, 1.2 A, 350 mΩ

### Features

- Shielded Gate MOSFET Technology
- Max  $r_{DS(on)}$  = 350 mΩ at  $V_{GS} = 10$  V,  $I_D = 1.2$  A
- Max  $r_{DS(on)}$  = 575 mΩ at  $V_{GS} = 6$  V,  $I_D = 0.9$  A
- High performance trench technology for extremely low  $r_{DS(on)}$
- High power and current handling capability in a widely used surface mount package
- Fast switching speed
- 100% UIL Tested
- RoHS Compliant

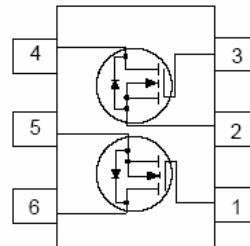
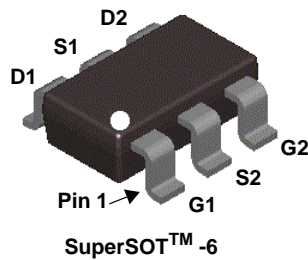


### General Description

This N-Channel MOSFET is produced using Fairchild Semiconductor's advanced PowerTrench® process that incorporates Shielded Gate technology. This process has been optimized for  $r_{DS(on)}$ , switching performance and ruggedness.

### Applications

- Load Switch
- Synchronous Rectifier



### MOSFET Maximum Ratings $T_A = 25$ °C unless otherwise noted

Symbol	Parameter	Ratings	Units
$V_{DS}$	Drain to Source Voltage	100	V
$V_{GS}$	Gate to Source Voltage	±20	V
$I_D$	Drain Current -Continuous (Note 1a)	1.2	A
	-Pulsed	5	A
$E_{AS}$	Single Pulse Avalanche Energy (Note 3)	1.5	mJ
$P_D$	Power Dissipation (Note 1a)	0.96	W
	Power Dissipation (Note 1b)	0.69	
$T_J, T_{STG}$	Operating and Storage Junction Temperature Range	-55 to +150	°C

### Thermal Characteristics

$R_{\theta JC}$	Thermal Resistance, Junction to Case	60	°C/W
$R_{\theta JA}$	Thermal Resistance, Junction to Ambient (Note 1a)	130	

### Package Marking and Ordering Information

Device Marking	Device	Package	Reel Size	Tape Width	Quantity
.862	FDC8602	SSOT-6	7"	8 mm	3000 units

## Electrical Characteristics $T_J = 25\text{ }^\circ\text{C}$ unless otherwise noted

Symbol	Parameter	Test Conditions	Min	Typ	Max	Units
--------	-----------	-----------------	-----	-----	-----	-------

### Off Characteristics

$BV_{DSS}$	Drain to Source Breakdown Voltage	$I_D = 250\text{ }\mu\text{A}$ , $V_{GS} = 0\text{ V}$	100			V
$\frac{\Delta BV_{DSS}}{\Delta T_J}$	Breakdown Voltage Temperature Coefficient	$I_D = 250\text{ }\mu\text{A}$ , referenced to $25\text{ }^\circ\text{C}$		73		mV/ $^\circ\text{C}$
$I_{DSS}$	Zero Gate Voltage Drain Current	$V_{DS} = 80\text{ V}$ , $V_{GS} = 0\text{ V}$			1	$\mu\text{A}$
$I_{GSS}$	Gate to Source Leakage Current	$V_{GS} = \pm 20\text{ V}$ , $V_{DS} = 0\text{ V}$			$\pm 100$	nA

### On Characteristics

$V_{GS(th)}$	Gate to Source Threshold Voltage	$V_{GS} = V_{DS}$ , $I_D = 250\text{ }\mu\text{A}$	2	3.2	4	V
$\frac{\Delta V_{GS(th)}}{\Delta T_J}$	Gate to Source Threshold Voltage Temperature Coefficient	$I_D = 250\text{ }\mu\text{A}$ , referenced to $25\text{ }^\circ\text{C}$		-8		mV/ $^\circ\text{C}$
$r_{DS(on)}$	Static Drain to Source On Resistance	$V_{GS} = 10\text{ V}$ , $I_D = 1.2\text{ A}$		285	350	m $\Omega$
		$V_{GS} = 6\text{ V}$ , $I_D = 0.9\text{ A}$		409	575	
		$V_{GS} = 10\text{ V}$ , $I_D = 1.2\text{ A}$ , $T_J = 125\text{ }^\circ\text{C}$		489	600	
$g_{FS}$	Forward Transconductance	$V_{DS} = 10\text{ V}$ , $I_D = 1.2\text{ A}$		1.3		S

### Dynamic Characteristics

$C_{iss}$	Input Capacitance	$V_{DS} = 50\text{ V}$ , $V_{GS} = 0\text{ V}$ , $f = 1\text{ MHz}$		53	70	pF
$C_{oss}$	Output Capacitance			17	25	pF
$C_{rss}$	Reverse Transfer Capacitance			0.8	5	pF
$R_g$	Gate Resistance			1.6		$\Omega$

### Switching Characteristics

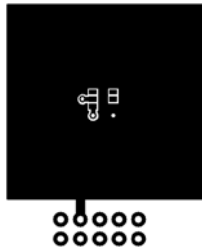
$t_{d(on)}$	Turn-On Delay Time	$V_{DD} = 50\text{ V}$ , $I_D = 1.2\text{ A}$ , $V_{GS} = 10\text{ V}$ , $R_{GEN} = 6\text{ }\Omega$		3.5	10	ns	
$t_r$	Rise Time			1.7	10	ns	
$t_{d(off)}$	Turn-Off Delay Time			5.4	11	ns	
$t_f$	Fall Time			2.3	10	ns	
$Q_{g(TOT)}$	Total Gate Charge		$V_{GS} = 0\text{ V to }10\text{ V}$		1.2	2	nC
$Q_{g(TOT)}$	Total Gate Charge	$V_{GS} = 0\text{ V to }5\text{ V}$	$V_{DD} = 50\text{ V}$ , $I_D = 1.2\text{ A}$		0.6	1	nC
$Q_{gs}$	Gate to Source Charge				0.4		nC
$Q_{gd}$	Gate to Drain "Miller" Charge				0.4		nC

### Drain-Source Diode Characteristics

$V_{SD}$	Source-Drain Diode Forward Voltage	$V_{GS} = 0\text{ V}$ , $I_S = 1.2\text{ A}$ (Note 2)		0.86	1.3	V
$t_{rr}$	Reverse Recovery Time	$I_F = 1.2\text{ A}$ , $di/dt = 100\text{ A}/\mu\text{s}$		27	43	ns
$Q_{rr}$	Reverse Recovery Charge			12	21	nC

#### NOTES:

- $R_{\theta JA}$  is the sum of the junction-to-case and case-to-ambient thermal resistance where the case thermal reference is defined as the solder mounting surface of the drain pins.  $R_{\theta JC}$  is guaranteed by design while  $R_{\theta CA}$  is determined by the user's board design.



a)  $130\text{ }^\circ\text{C/W}$  when mounted on a  $1\text{ in}^2$  pad of 2oz copper

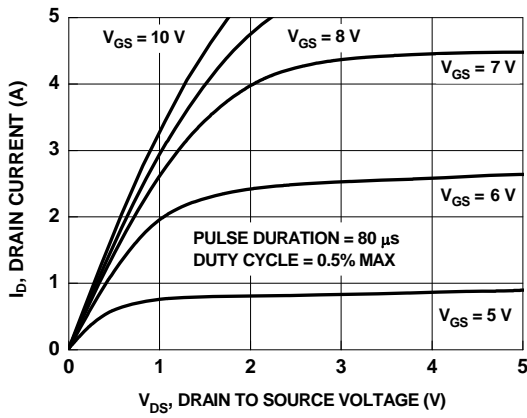


b)  $180\text{ }^\circ\text{C/W}$  when mounted on a minimum pad of 2oz copper

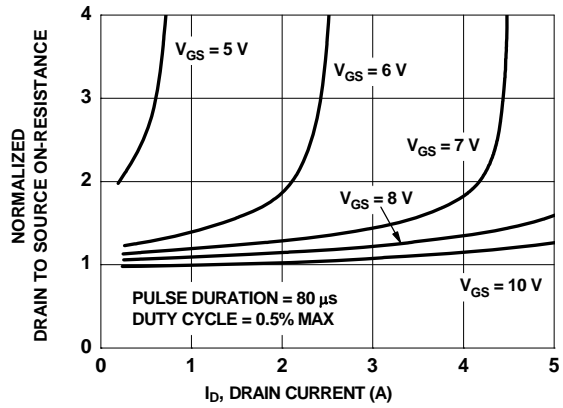
2. Pulse Test: Pulse Width <  $300\text{ }\mu\text{s}$ , Duty cycle < 2.0%.

3. Starting  $T_J = 25\text{ }^\circ\text{C}$ ; N-ch:  $L = 3\text{ mH}$ ,  $I_{AS} = 1\text{ A}$ ,  $V_{DD} = 100\text{ V}$ ,  $V_{GS} = 10\text{ V}$ .

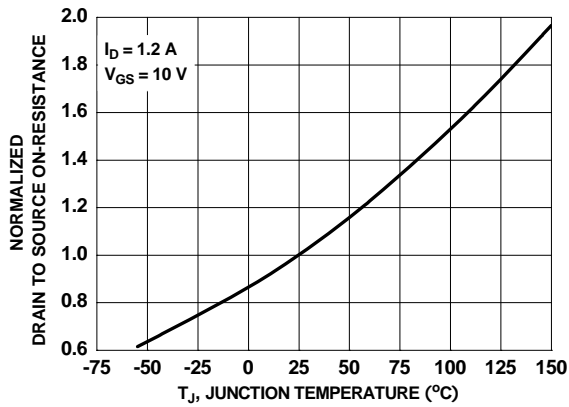
**Typical Characteristics**  $T_J = 25\text{ }^\circ\text{C}$  unless otherwise noted



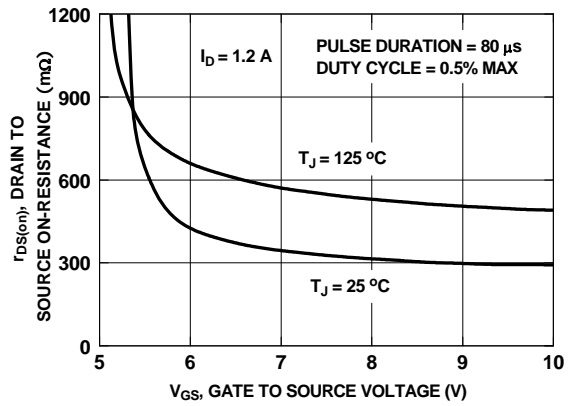
**Figure 1. On Region Characteristics**



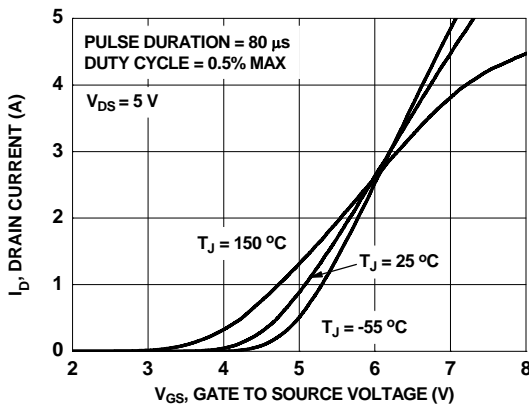
**Figure 2. Normalized On-Resistance vs Drain Current and Gate Voltage**



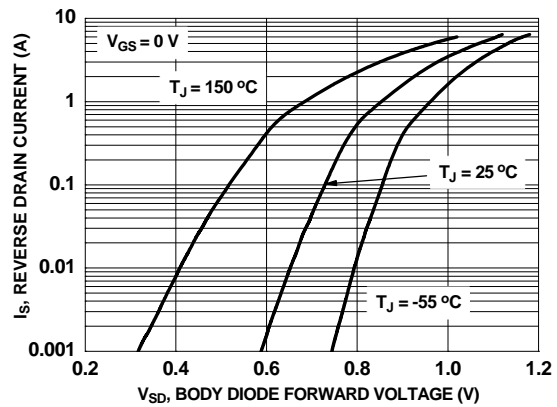
**Figure 3. Normalized On Resistance vs Junction Temperature**



**Figure 4. On-Resistance vs Gate to Source Voltage**

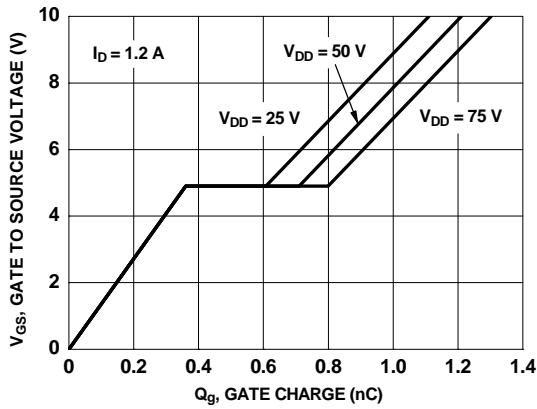


**Figure 5. Transfer Characteristics**

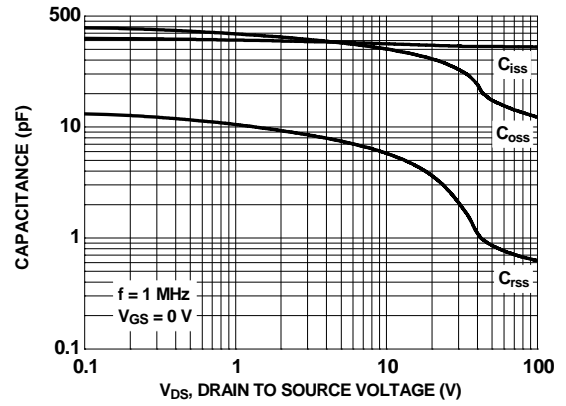


**Figure 6. Source to Drain Diode Forward Voltage vs Source Current**

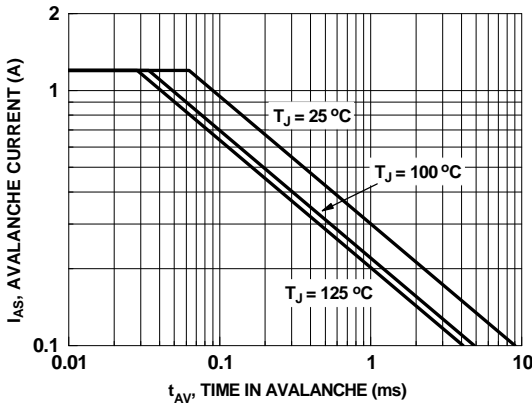
**Typical Characteristics**  $T_J = 25\text{ }^\circ\text{C}$  unless otherwise noted



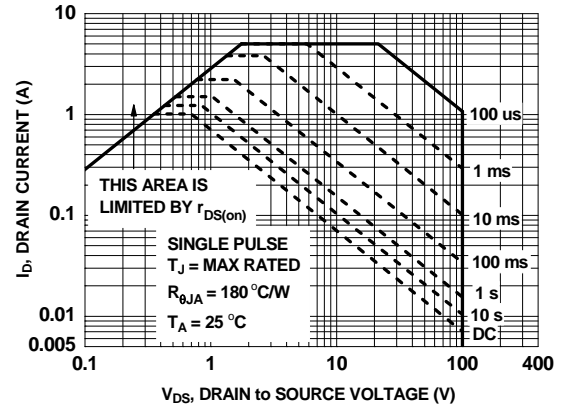
**Figure 7. Gate Charge Characteristics**



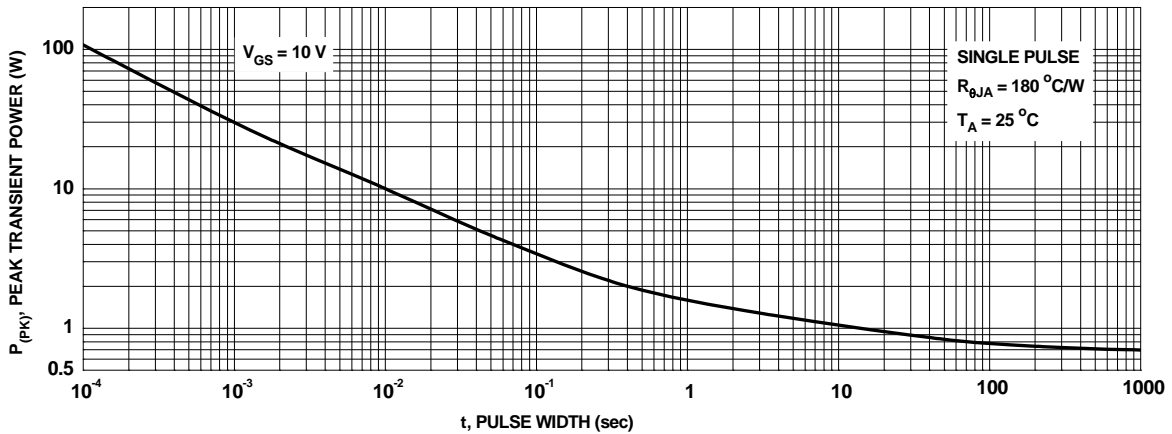
**Figure 8. Capacitance vs Drain to Source Voltage**



**Figure 9. Unclamped Inductive Switching Capability**

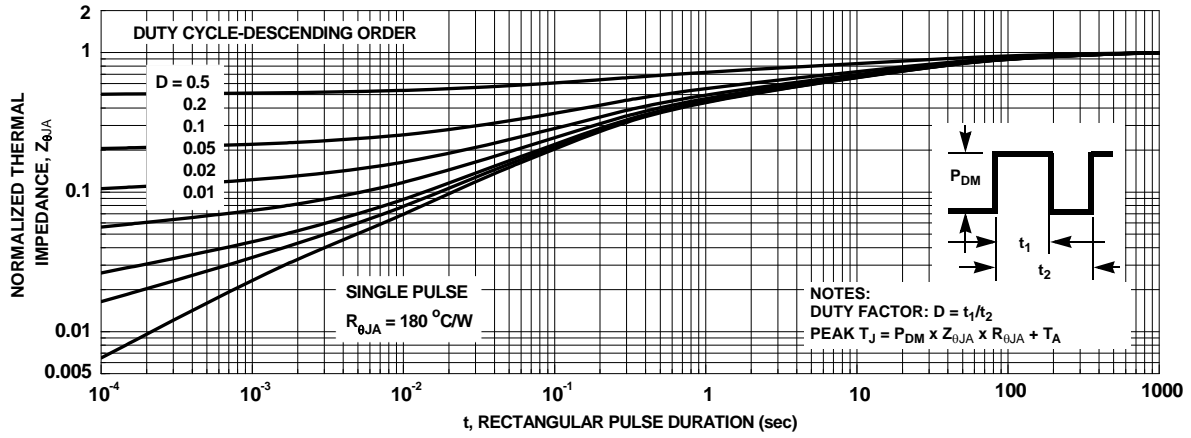


**Figure 10. Forward Bias Safe Operating Area**



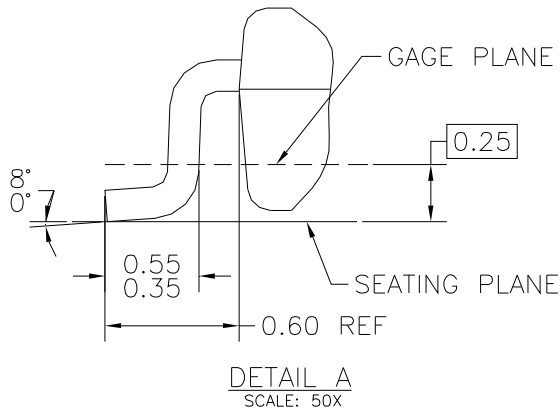
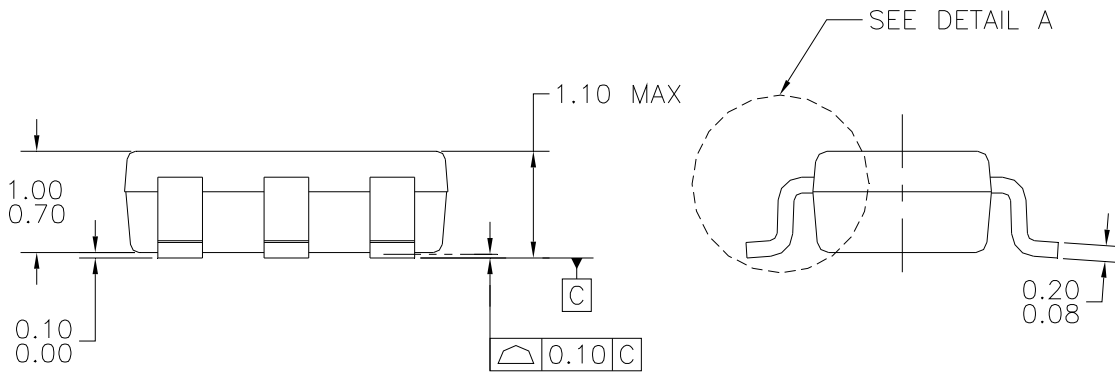
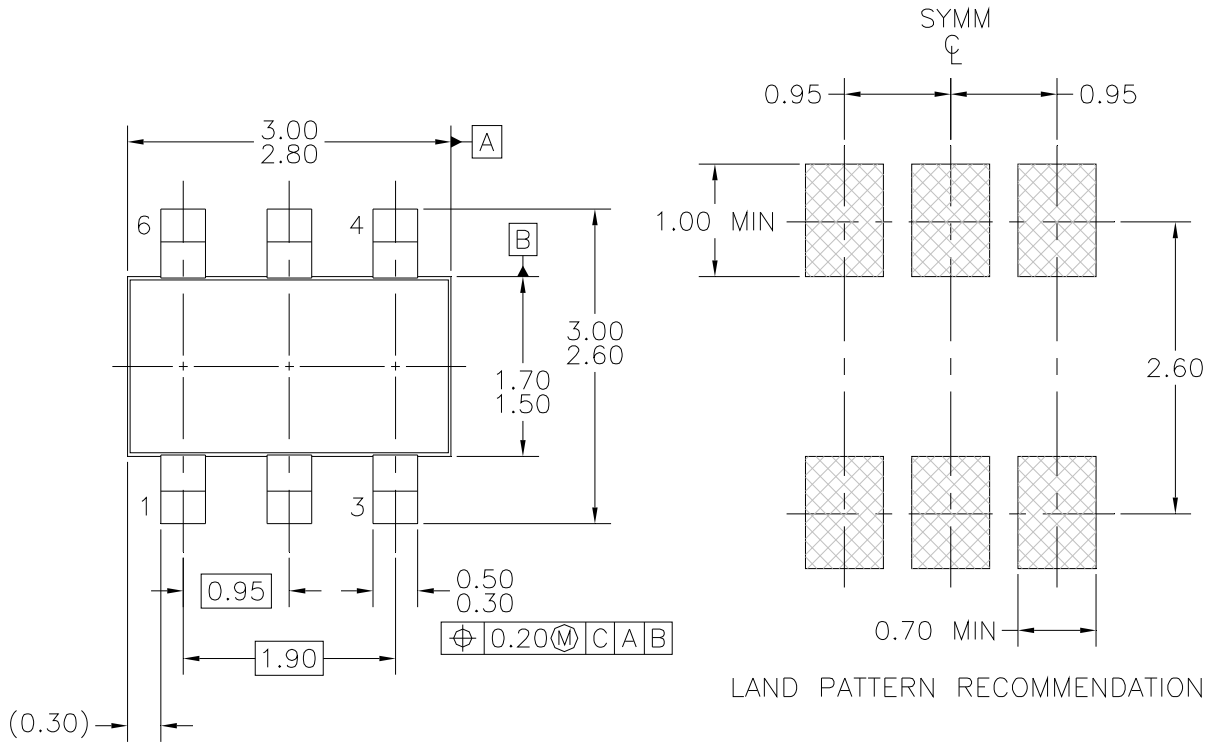
**Figure 11. Single Pulse Maximum Power Dissipation**

**Typical Characteristics**  $T_J = 25\text{ }^\circ\text{C}$  unless otherwise noted



**Figure 12. Junction-to-Ambient Transient Thermal Response Curve**

### Dimensional Outline and Pad Layout



NOTES: UNLESS OTHERWISE SPECIFIED


- A) THIS PACKAGE CONFORMS TO JEDEC MO-193. VAR. AA, ISSUE C, DATED JANUARY 2000.
- B) ALL DIMENSIONS ARE IN MILLIMETERS.

MA06AREVD



**TRADEMARKS**

The following includes registered and unregistered trademarks and service marks, owned by Fairchild Semiconductor and/or its global subsidiaries, and is not intended to be an exhaustive list of all such trademarks.

- |                                                                                              |                                                 |                                       |                  |
|----------------------------------------------------------------------------------------------|-------------------------------------------------|---------------------------------------|------------------|
| 2Cool™                                                                                       | FPST™                                           | PowerTrench®                          | Sync-Lock™       |
| AccuPower™                                                                                   | F-PFST™                                         | PowerXST™                             | SYSTEM GENERAL®* |
| AX-CAP®*                                                                                     | FRFET®                                          | Programmable Active Droop™            | TinyBoost™       |
| BitSiC™                                                                                      | Global Power Resource <sup>SM</sup>             | QFET®                                 | TinyBuck™        |
| Build it Now™                                                                                | Green Bridge™                                   | QS™                                   | TinyCalc™        |
| CorePLUS™                                                                                    | Green FPS™                                      | Quiet Series™                         | TinyLogic®       |
| CorePOWER™                                                                                   | Green FPS™ e-Series™                            | RapidConfigure™                       | TINYOPTO™        |
| CROSSVOLT™                                                                                   | Gmax™                                           | TinyPower™                            | TinyPWM™         |
| CTL™                                                                                         | GTO™                                            | TinyWire™                             | TransiC™         |
| Current Transfer Logic™                                                                      | IntelliMAX™                                     | TriFault Detect™                      | TRUECURRENT®*    |
| DEUXPEED®                                                                                    | ISOPLANAR™                                      | TRUESERDES™                           | μSerDes™         |
| Dual Cool™                                                                                   | Marking Small Speakers Sound Louder and Better™ | UHC™                                  | Ultra FRFET™     |
| EcoSPARK®                                                                                    | MegaBuck™                                       | UniFET™                               | VCX™             |
| EfficientMax™                                                                                | MICROCOUPLER™                                   | VisualMax™                            | VoltagePlus™     |
| ESBC™                                                                                        | MicroFET™                                       | XS™                                   |                  |
|  Fairchild® | MicroPak™                                       |                                       |                  |
| Fairchild Semiconductor®                                                                     | MicroPak2™                                      |                                       |                  |
| FACT Quiet Series™                                                                           | MillerDrive™                                    |                                       |                  |
| FACT®                                                                                        | MotionMax™                                      |                                       |                  |
| FAST®                                                                                        | mWSaver™                                        |                                       |                  |
| FastvCore™                                                                                   | OptoHiT™                                        |                                       |                  |
| FETBench™                                                                                    | OPTOLOGIC®                                      |                                       |                  |
|                                                                                              | OPTOPLANAR®                                     |                                       |                  |
|                                                                                              |                                                 | Saving our world, 1mW/W/kW at a time™ |                  |
|                                                                                              |                                                 | SignalWise™                           |                  |
|                                                                                              |                                                 | SmartMax™                             |                  |
|                                                                                              |                                                 | SMART START™                          |                  |
|                                                                                              |                                                 | Solutions for Your Success™           |                  |
|                                                                                              |                                                 | SPM®                                  |                  |
|                                                                                              |                                                 | STEALTH™                              |                  |
|                                                                                              |                                                 | SuperFET®                             |                  |
|                                                                                              |                                                 | SuperSOT™-3                           |                  |
|                                                                                              |                                                 | SuperSOT™-6                           |                  |
|                                                                                              |                                                 | SuperSOT™-8                           |                  |
|                                                                                              |                                                 | SupreMOS®                             |                  |
|                                                                                              |                                                 | SyncFET™                              |                  |

\*Trademarks of System General Corporation, used under license by Fairchild Semiconductor.

**DISCLAIMER**

FAIRCHILD SEMICONDUCTOR RESERVES THE RIGHT TO MAKE CHANGES WITHOUT FURTHER NOTICE TO ANY PRODUCTS HEREIN TO IMPROVE RELIABILITY, FUNCTION, OR DESIGN. FAIRCHILD DOES NOT ASSUME ANY LIABILITY ARISING OUT OF THE APPLICATION OR USE OF ANY PRODUCT OR CIRCUIT DESCRIBED HEREIN; NEITHER DOES IT CONVEY ANY LICENSE UNDER ITS PATENT RIGHTS, NOR THE RIGHTS OF OTHERS. THESE SPECIFICATIONS DO NOT EXPAND THE TERMS OF FAIRCHILD'S WORLDWIDE TERMS AND CONDITIONS, SPECIFICALLY THE WARRANTY THEREIN, WHICH COVERS THESE PRODUCTS.

**LIFE SUPPORT POLICY**

FAIRCHILD'S PRODUCTS ARE NOT AUTHORIZED FOR USE AS CRITICAL COMPONENTS IN LIFE SUPPORT DEVICES OR SYSTEMS WITHOUT THE EXPRESS WRITTEN APPROVAL OF FAIRCHILD SEMICONDUCTOR CORPORATION.

As used here in:

- Life support devices or systems are devices or systems which, (a) are intended for surgical implant into the body or (b) support or sustain life, and (c) whose failure to perform when properly used in accordance with instructions for use provided in the labeling, can be reasonably expected to result in a significant injury of the user.
- A critical component in any component of a life support, device, or system whose failure to perform can be reasonably expected to cause the failure of the life support device or system, or to affect its safety or effectiveness.

**ANTI-COUNTERFEITING POLICY**

Fairchild Semiconductor Corporation's Anti-Counterfeiting Policy. Fairchild's Anti-Counterfeiting Policy is also stated on our external website, www.Fairchildsemi.com, under Sales Support. Counterfeiting of semiconductor parts is a growing problem in the industry. All manufactures of semiconductor products are experiencing counterfeiting of their parts. Customers who inadvertently purchase counterfeit parts experience many problems such as loss of brand reputation, substandard performance, failed application, and increased cost of production and manufacturing delays. Fairchild is taking strong measures to protect ourselves and our customers from the proliferation of counterfeit parts. Fairchild strongly encourages customers to purchase Fairchild parts either directly from Fairchild or from Authorized Fairchild Distributors who are listed by country on our web page cited above. Products customers buy either from Fairchild directly or from Authorized Fairchild Distributors are genuine parts, have full traceability, meet Fairchild's quality standards for handling and storage and provide access to Fairchild's full range of up-to-date technical and product information. Fairchild and our Authorized Distributors will stand behind all warranties and will appropriately address and warranty issues that may arise. Fairchild will not provide any warranty coverage or other assistance for parts bought from Unauthorized Sources. Fairchild is committed to combat this global problem and encourage our customers to do their part in stopping this practice by buying direct or from authorized distributors.

**PRODUCT STATUS DEFINITIONS**

**Definition of Terms**

Datasheet Identification	Product Status	Definition
Advance Information	Formative / In Design	Datasheet contains the design specifications for product development. Specifications may change in any manner without notice.
Preliminary	First Production	Datasheet contains preliminary data; supplementary data will be published at a later date. Fairchild Semiconductor reserves the right to make changes at any time without notice to improve design.
No Identification Needed	Full Production	Datasheet contains final specifications. Fairchild Semiconductor reserves the right to make changes at any time without notice to improve the design.
Obsolete	Not In Production	Datasheet contains specifications on a product that is discontinued by Fairchild Semiconductor. The datasheet is for reference information only.



ON Semiconductor and  are trademarks of Semiconductor Components Industries, LLC dba ON Semiconductor or its subsidiaries in the United States and/or other countries. ON Semiconductor owns the rights to a number of patents, trademarks, copyrights, trade secrets, and other intellectual property. A listing of ON Semiconductor's product/patent coverage may be accessed at [www.onsemi.com/site/pdf/Patent-Marking.pdf](http://www.onsemi.com/site/pdf/Patent-Marking.pdf). ON Semiconductor reserves the right to make changes without further notice to any products herein. ON Semiconductor makes no warranty, representation or guarantee regarding the suitability of its products for any particular purpose, nor does ON Semiconductor assume any liability arising out of the application or use of any product or circuit, and specifically disclaims any and all liability, including without limitation special, consequential or incidental damages. Buyer is responsible for its products and applications using ON Semiconductor products, including compliance with all laws, regulations and safety requirements or standards, regardless of any support or applications information provided by ON Semiconductor. "Typical" parameters which may be provided in ON Semiconductor data sheets and/or specifications can and do vary in different applications and actual performance may vary over time. All operating parameters, including "Typicals" must be validated for each customer application by customer's technical experts. ON Semiconductor does not convey any license under its patent rights nor the rights of others. ON Semiconductor products are not designed, intended, or authorized for use as a critical component in life support systems or any FDA Class 3 medical devices or medical devices with a same or similar classification in a foreign jurisdiction or any devices intended for implantation in the human body. Should Buyer purchase or use ON Semiconductor products for any such unintended or unauthorized application, Buyer shall indemnify and hold ON Semiconductor and its officers, employees, subsidiaries, affiliates, and distributors harmless against all claims, costs, damages, and expenses, and reasonable attorney fees arising out of, directly or indirectly, any claim of personal injury or death associated with such unintended or unauthorized use, even if such claim alleges that ON Semiconductor was negligent regarding the design or manufacture of the part. ON Semiconductor is an Equal Opportunity/Affirmative Action Employer. This literature is subject to all applicable copyright laws and is not for resale in any manner.

## PUBLICATION ORDERING INFORMATION

### LITERATURE FULFILLMENT:

Literature Distribution Center for ON Semiconductor  
19521 E. 32nd Pkwy, Aurora, Colorado 80011 USA  
**Phone:** 303-675-2175 or 800-344-3860 Toll Free USA/Canada  
**Fax:** 303-675-2176 or 800-344-3867 Toll Free USA/Canada  
**Email:** [orderlit@onsemi.com](mailto:orderlit@onsemi.com)

**N. American Technical Support:** 800-282-9855 Toll Free  
USA/Canada  
**Europe, Middle East and Africa Technical Support:**  
Phone: 421 33 790 2910  
**Japan Customer Focus Center**  
Phone: 81-3-5817-1050

**ON Semiconductor Website:** [www.onsemi.com](http://www.onsemi.com)  
**Order Literature:** <http://www.onsemi.com/orderlit>  
For additional information, please contact your local  
Sales Representative