



Is Now Part of



**ON Semiconductor®**

To learn more about ON Semiconductor, please visit our website at  
[www.onsemi.com](http://www.onsemi.com)

Please note: As part of the Fairchild Semiconductor integration, some of the Fairchild orderable part numbers will need to change in order to meet ON Semiconductor's system requirements. Since the ON Semiconductor product management systems do not have the ability to manage part nomenclature that utilizes an underscore (\_), the underscore (\_) in the Fairchild part numbers will be changed to a dash (-). This document may contain device numbers with an underscore (\_). Please check the ON Semiconductor website to verify the updated device numbers. The most current and up-to-date ordering information can be found at [www.onsemi.com](http://www.onsemi.com). Please email any questions regarding the system integration to [Fairchild\\_questions@onsemi.com](mailto:Fairchild_questions@onsemi.com).

ON Semiconductor and the ON Semiconductor logo are trademarks of Semiconductor Components Industries, LLC dba ON Semiconductor or its subsidiaries in the United States and/or other countries. ON Semiconductor owns the rights to a number of patents, trademarks, copyrights, trade secrets, and other intellectual property. A listing of ON Semiconductor's product/patent coverage may be accessed at [www.onsemi.com/site/pdf/Patent-Marking.pdf](http://www.onsemi.com/site/pdf/Patent-Marking.pdf). ON Semiconductor reserves the right to make changes without further notice to any products herein. ON Semiconductor makes no warranty, representation or guarantee regarding the suitability of its products for any particular purpose, nor does ON Semiconductor assume any liability arising out of the application or use of any product or circuit, and specifically disclaims any and all liability, including without limitation special, consequential or incidental damages. Buyer is responsible for its products and applications using ON Semiconductor products, including compliance with all laws, regulations and safety requirements or standards, regardless of any support or applications information provided by ON Semiconductor. "Typical" parameters which may be provided in ON Semiconductor data sheets and/or specifications can and do vary in different applications and actual performance may vary over time. All operating parameters, including "Typicals" must be validated for each customer application by customer's technical experts. ON Semiconductor does not convey any license under its patent rights nor the rights of others. ON Semiconductor products are not designed, intended, or authorized for use as a critical component in life support systems or any FDA Class 3 medical devices or medical devices with a same or similar classification in a foreign jurisdiction or any devices intended for implantation in the human body. Should Buyer purchase or use ON Semiconductor products for any such unintended or unauthorized application, Buyer shall indemnify and hold ON Semiconductor and its officers, employees, subsidiaries, affiliates, and distributors harmless against all claims, costs, damages, and expenses, and reasonable attorney fees arising out of, directly or indirectly, any claim of personal injury or death associated with such unintended or unauthorized use, even if such claim alleges that ON Semiconductor was negligent regarding the design or manufacture of the part. ON Semiconductor is an Equal Opportunity/Affirmative Action Employer. This literature is subject to all applicable copyright laws and is not for resale in any manner.

## FDC6320C Dual N & P Channel , Digital FET

### General Description

These dual N & P Channel logic level enhancement mode field effect transistors are produced using Fairchild's proprietary, high cell density, DMOS technology. This very high density process is especially tailored to minimize on-state resistance. The device is an improved design especially for low voltage applications as a replacement for bipolar digital transistors in load switching applications. Since bias resistors are not required, this dual digital FET can replace several digital transistors with difference bias resistors.

### Features

- N-Ch 25 V, 0.22 A,  $R_{DS(ON)} = 5 \Omega @ V_{GS} = 2.7 V$ .
- P-Ch 25 V, -0.12 A,  $R_{DS(ON)} = 13 \Omega @ V_{GS} = -2.7 V$ .
- Very low level gate drive requirements allowing direct operation in 3 V circuits.  $V_{GS(th)} < 1.5 V$ .
- Gate-Source Zener for ESD ruggedness. >6kV Human Body Model
- Replace NPN & PNP digital transistors.

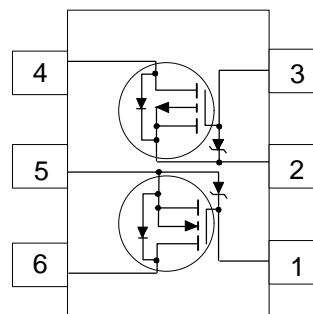
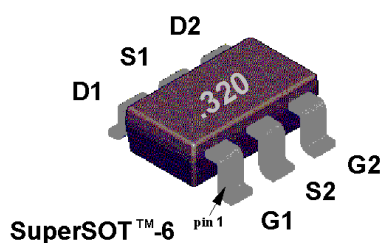

### Absolute Maximum Ratings $T_A = 25^\circ\text{C}$ unless other wise noted

Symbol	Parameter	N-Channel	P-Channel	Units
$V_{DSS}, V_{CC}$	Drain-Source Voltage, Power Supply Voltage	25	-25	V
$V_{GSS}, V_{IN}$	Gate-Source Voltage,	8	-8	V
$I_D, I_O$	Drain/Output Current - Continuous	0.22	-0.12	A
	- Pulsed	0.5	-0.5	
$P_D$	Maximum Power Dissipation (Note 1a) (Note 1b)	0.9		W
		0.7		
$T_J, T_{STG}$	Operating and Storage Temperature Ranager	-55 to 150		$^\circ\text{C}$
ESD	Electrostatic Discharge Rating MIL-STD-883D Human Body Model (100pf / 1500 Ohm)	6		kV

### THERMAL CHARACTERISTICS

$R_{\theta JA}$	Thermal Resistance, Junction-to-Ambient (Note 1a)	140	$^\circ\text{C/W}$
$R_{\theta JC}$	Thermal Resistance, Junction-to-Case (Note 1)	60	$^\circ\text{C/W}$

**DMOS Electrical Characteristics** ( $T_A = 25\text{ }^\circ\text{C}$  unless otherwise noted)

Symbol	Parameter	Conditions	Type	Min	Typ	Max	Units
<b>OFF CHARACTERISTICS</b>							
$BV_{DSS}$	Drain-Source Breakdown Voltage	$V_{GS} = 0\text{ V}, I_D = 250\text{ }\mu\text{A}$	N-Ch	25			V
		$V_{GS} = 0\text{ V}, I_D = -250\text{ }\mu\text{A}$	P-Ch	-25			
$\Delta BV_{DSS}/\Delta T_J$	Breakdown Voltage Temp. Coefficient	$I_D = 250\text{ }\mu\text{A}$ , Referenced to $25\text{ }^\circ\text{C}$	N-Ch		25		$\text{mV}/^\circ\text{C}$
		$I_D = -250\text{ }\mu\text{A}$ , Referenced to $25\text{ }^\circ\text{C}$	P-Ch		-20		
$I_{DSS}$	Zero Gate Voltage Drain Current	$V_{DS} = 20\text{ V}, V_{GS} = 0\text{ V}$ , $T_J = 55\text{ }^\circ\text{C}$	N-Ch			1 10	$\mu\text{A}$
		$V_{DS} = -20\text{ V}, V_{GS} = 0\text{ V}$ , $T_J = 55\text{ }^\circ\text{C}$	P-Ch			-1 -10	
$I_{GSS}$	Gate - Body Leakage Current	$V_{GS} = 8\text{ V}, V_{DS} = 0\text{ V}$	N-Ch			100	nA
		$V_{GS} = -8\text{ V}, V_{DS} = 0\text{ V}$	P-Ch			-100	nA
<b>ON CHARACTERISTICS</b> (Note 2)							
$\Delta V_{GS(th)}/\Delta T_J$	Gate Threshold Voltage Temp. Coefficient	$I_D = 250\text{ }\mu\text{A}$ , Referenced to $25\text{ }^\circ\text{C}$	N-Ch		-2.1		$\text{mV}/^\circ\text{C}$
		$I_D = -250\text{ }\mu\text{A}$ , Referenced to $25\text{ }^\circ\text{C}$	P-Ch		1.9		
$V_{GS(th)}$	Gate Threshold Voltage	$V_{DS} = V_{GS}, I_D = 250\text{ }\mu\text{A}$	N-Ch	0.65	0.85	1.5	V
		$V_{DS} = V_{GS}, I_D = -250\text{ }\mu\text{A}$	P-Ch	-0.65	-1	-1.5	
$R_{DS(on)}$	Static Drain-Source On-Resistance	$V_{GS} = 2.7\text{ V}, I_D = 0.2\text{ A}$ , $T_J = 125\text{ }^\circ\text{C}$	N-Ch		3.8	5	$\Omega$
		$V_{GS} = 4.5\text{ V}, I_D = 0.4\text{ A}$			6.3	9	
		$V_{GS} = -2.7\text{ V}, I_D = -0.05\text{ A}$ , $T_J = 125\text{ }^\circ\text{C}$	P-Ch		10.6	13	
		$V_{GS} = -4.5\text{ V}, I_D = -0.2\text{ A}$			15	21	
					7.9	10	
$I_{D(on)}$	On-State Drain Current	$V_{GS} = 2.7\text{ V}, V_{DS} = 5\text{ V}$	N-Ch	0.2			A
		$V_{GS} = -2.7\text{ V}, V_{DS} = -5\text{ V}$	P-Ch	-0.05			
$g_{FS}$	Forward Transconductance	$V_{DS} = 5\text{ V}, I_D = 0.4\text{ A}$	N-Ch		0.2		S
		$V_{DS} = -5\text{ V}, I_D = -0.2\text{ A}$	P-Ch		0.135		
<b>DYNAMIC CHARACTERISTICS</b>							
$C_{iss}$	Input Capacitance	N-Channel $V_{DS} = 10\text{ V}, V_{GS} = 0\text{ V}$ , $f = 1.0\text{ MHz}$	N-Ch		9.5		pF
			P-Ch		11		
$C_{oss}$	Output Capacitance	P-Channel $V_{DS} = -10\text{ V}, V_{GS} = 0\text{ V}$ , $f = 1.0\text{ MHz}$	N-Ch		6		pF
			P-Ch		7		
$C_{rss}$	Reverse Transfer Capacitance		N-Ch		1.3		pF
			P-Ch		1.4		

## DMOS Electrical Characteristics ( $T_A = 25\text{ }^\circ\text{C}$ unless otherwise noted )

Symbol	Parameter	Conditions	Type	Min	Typ	Max	Units
<b>SWITCHING CHARACTERISTICS</b> (Note 2)							
$t_{D(on)}$	Turn - On Delay Time	N-Channel $V_{DD} = 6\text{ V}$ , $I_D = 0.5\text{ A}$ ,	N-Ch		5	11	nS
			P-Ch		6	12	
$t_r$	Turn - On Rise Time	$V_{GS} = 4.5\text{ V}$ , $R_{GEN} = 50\ \Omega$	N-Ch		4.5	10	nS
			P-Ch		6	12	
$t_{D(off)}$	Turn - Off Delay Time	P-Channel $V_{DD} = -6\text{ V}$ , $I_D = -0.5\text{ A}$ ,	N-Ch		4	10	nS
			P-Ch		7.4	15	
$t_f$	Turn - Off Fall Time	$V_{GEN} = -4.5\text{ V}$ , $R_{GEN} = 50\ \Omega$	N-Ch		3.2	8	nS
			P-Ch		4	10	
$Q_g$	Total Gate Charge	N-Channel $V_{DS} = 5\text{ V}$ , $I_D = 0.2\text{ A}$ , $V_{GS} = 4.5\text{ V}$	N-Ch		0.29	0.4	nC
			P-Ch		0.23	0.32	
$Q_{gs}$	Gate-Source Charge	P-Channel $V_{DS} = -5\text{ V}$ , $I_D = -0.2\text{ A}$ , $V_{GS} = -4.5\text{ V}$	N-Ch		0.105		nC
			P-Ch		0.12		
$Q_{gd}$	Gate-Drain Charge		N-Ch		0.045		nC
			P-Ch		0.03		
<b>DRAIN-SOURCE DIODE CHARACTERISTICS AND MAXIMUM RATINGS</b>							
$I_S$	Maximum Continuous Drain-Source Diode Forward Current		N-Ch			0.5	A
			P-Ch			-0.5	
$V_{SD}$	Drain-Source Diode Forward Voltage	$V_{GS} = 0\text{ V}$ , $I_S = 0.5\text{ A}$ (Note 2)	N-Ch		0.97	1.3	V
		$V_{GS} = 0\text{ V}$ , $I_S = -0.5\text{ A}$ (Note 2)	P-Ch		-1	-1.3	

**Notes:**

- $R_{\theta JA}$  is the sum of the junction-to-case and case-to-ambient thermal resistance where the case thermal reference is defined as the solder mounting surface of the drain pins.  $R_{\theta JC}$  is guaranteed by design while  $R_{\theta CA}$  is determined by the user's board design.

Typical  $R_{\theta JA}$  using the board layouts shown below on FR-4 PCB in a still air environment:

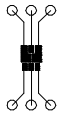

a.  $140^\circ\text{C/W}$  on a  $0.125\text{ in}^2$  pad of 2oz copper.

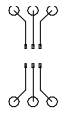

b.  $180^\circ\text{C/W}$  on a  $0.005\text{ in}^2$  pad of 2oz copper.

Scale 1 : 1 on letter size paper

- Pulse Test: Pulse Width  $\leq 300\ \mu\text{s}$ , Duty Cycle  $\leq 2.0\%$ .

## Typical Electrical Characteristics: N-Channel

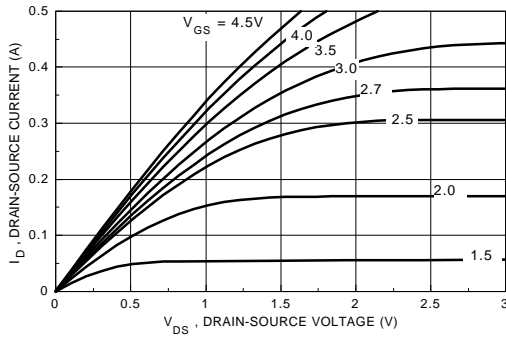

Figure 1. On-Region Characteristics.

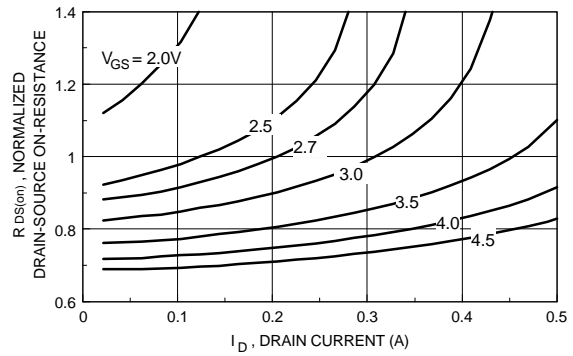

Figure 2. On-Resistance Variation with Drain Current and Gate Voltage.

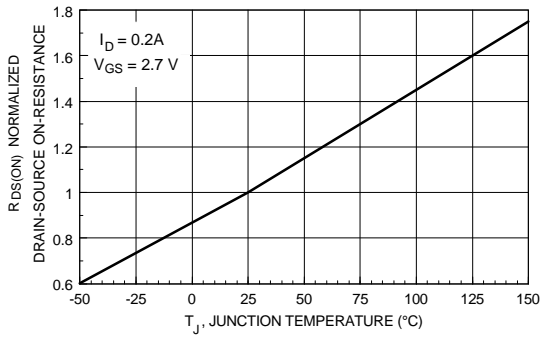

Figure 3. On-Resistance Variation with Temperature.

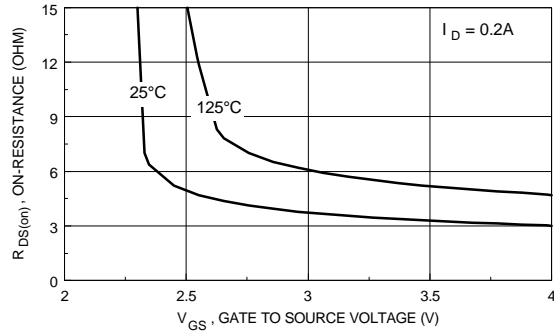

Figure 4. On Resistance Variation with Gate-To-Source Voltage.

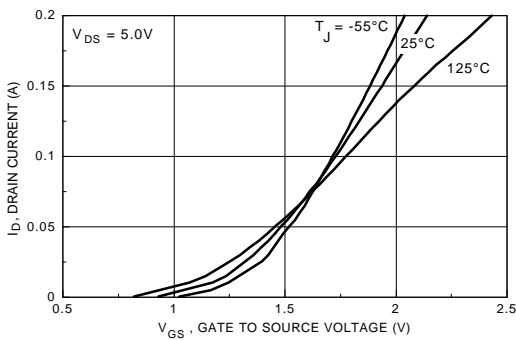

Figure 5. Transfer Characteristics.

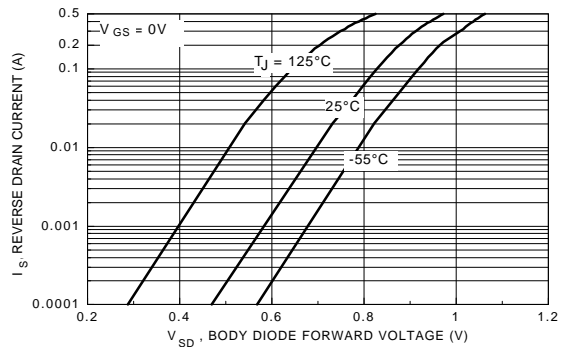

Figure 6. Body Diode Forward Voltage Variation with Source Current and Temperature.

## Typical Electrical Characteristics: N-Channel (continued)

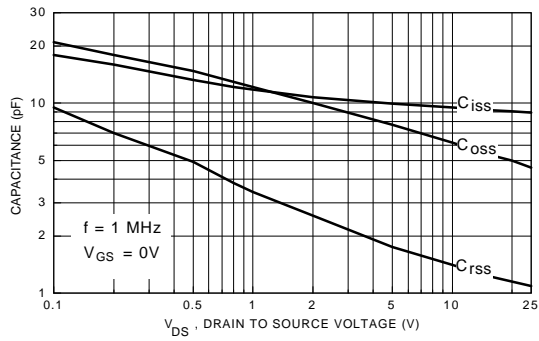

Figure 7. Capacitance Characteristics.

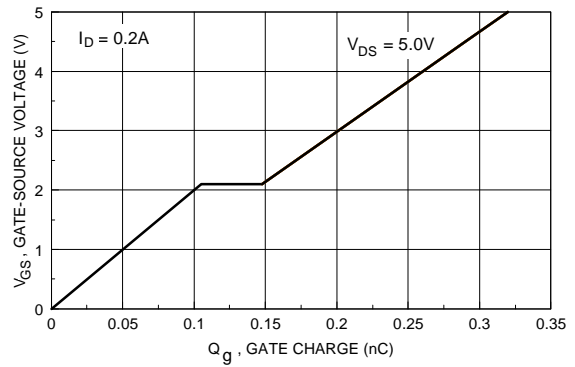

Figure 8. Gate Charge Characteristics.

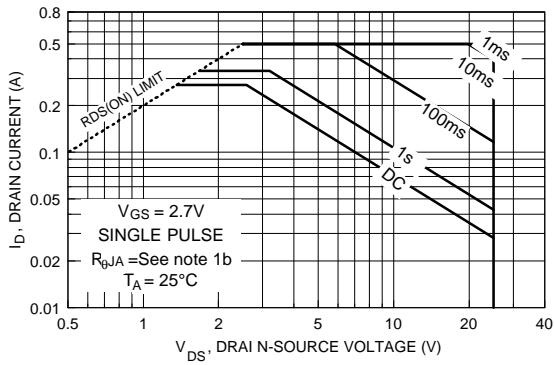

Figure 9. Maximum Safe Operating Area.

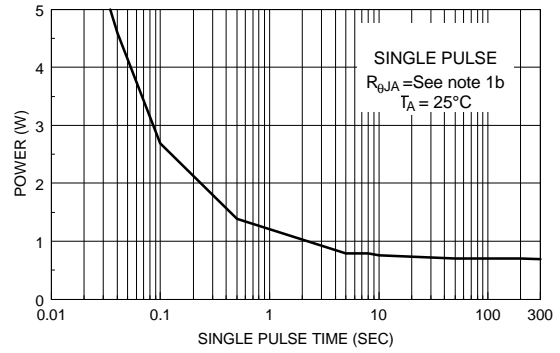

Figure 10. Single Pulse Maximum Power Dissipation.

## Typical Electrical Characteristics: P-Channel

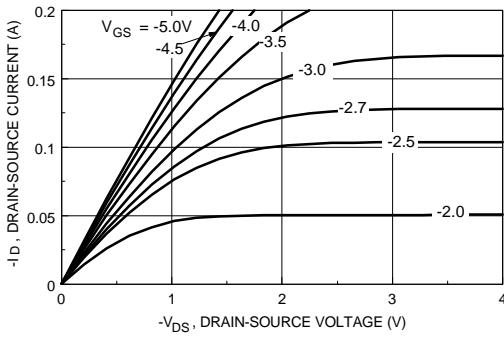

Figure 11. On-Region Characteristics.

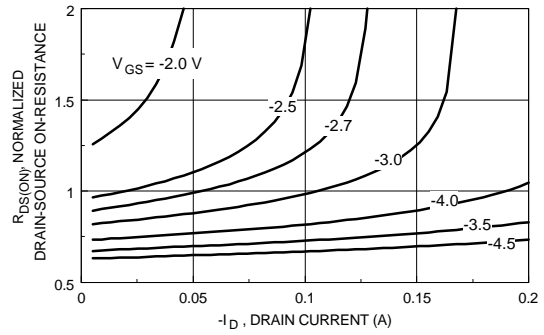

Figure 12. On-Resistance Variation with Drain Current and Gate Voltage.

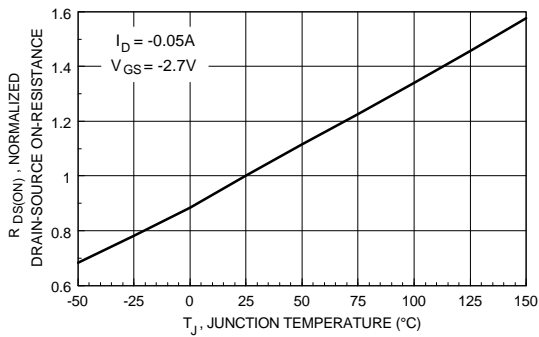

Figure 13. On-Resistance Variation with Temperature.

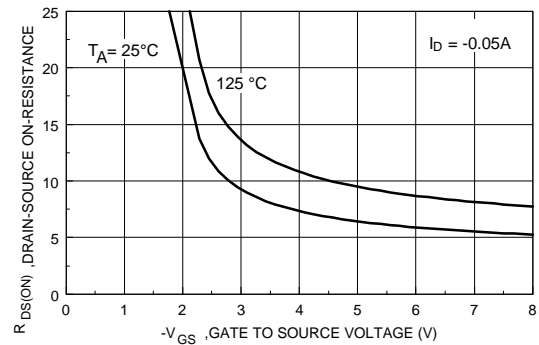

Figure 14. On Resistance Variation with Gate-To- Source Voltage.

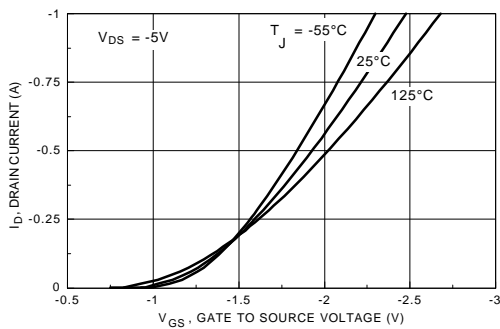

Figure 15. Transfer Characteristics.

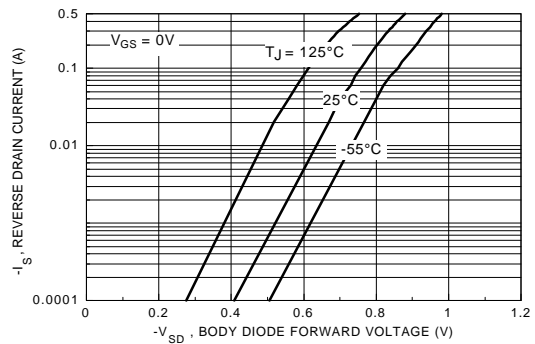

Figure 16. Body Diode Forward Voltage Variation with Source Current and Temperature.

## Typical Electrical Characteristics: P-Channel (continued)

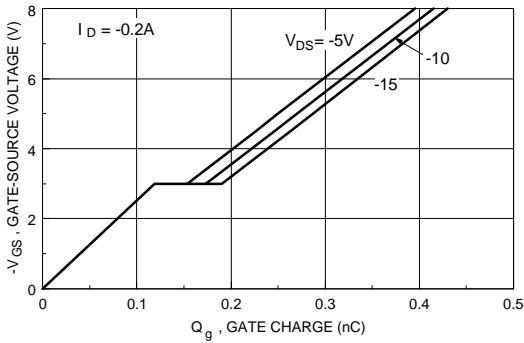

Figure 17. Gate Charge Characteristics.

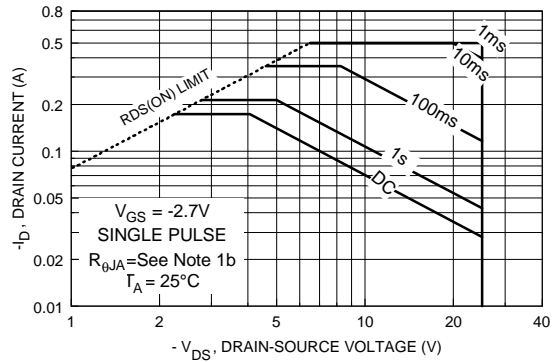

Figure 18. Maximum Safe Operating Area.

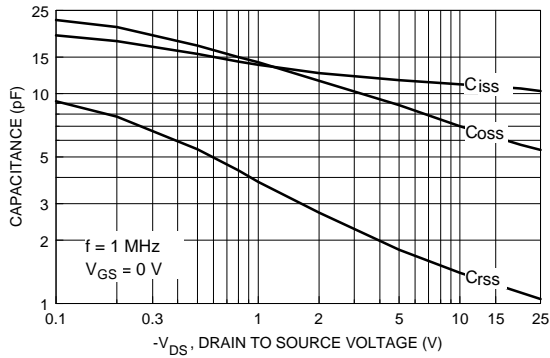

Figure 19. Capacitance Characteristics.

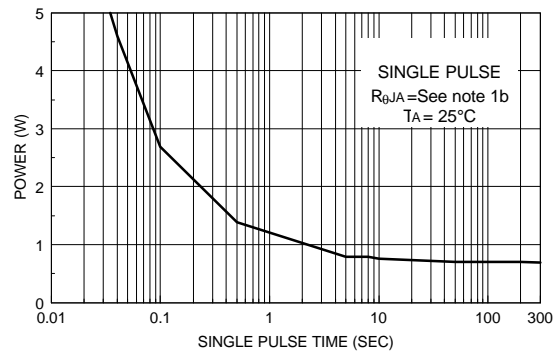

Figure 20. Single Pulse Maximum Power Dissipation.

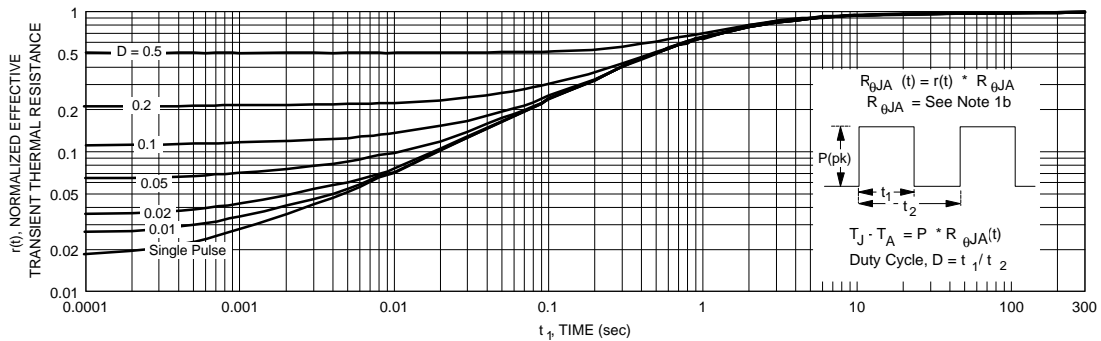

Figure 21. Transient Thermal Response Curve.

Note: Thermal characterization performed using the conditions described in note 1b. Transient thermal response will change depending on the circuit board design.



## TRADEMARKS

The following are registered and unregistered trademarks Fairchild Semiconductor owns or is authorized to use and is not intended to be an exhaustive list of all such trademarks.

ACE <sub>x</sub> <sup>TM</sup>	FAST <sup>®</sup>	OPTOLOGIC <sup>TM</sup>	SMART START <sup>TM</sup>	VCX <sup>TM</sup>
Bottomless <sup>TM</sup>	FAST <sub>r</sub> <sup>TM</sup>	OPTOPLANAR <sup>TM</sup>	STAR*POWER <sup>TM</sup>	
CoolFET <sup>TM</sup>	FRFET <sup>TM</sup>	PACMAN <sup>TM</sup>	Stealth <sup>TM</sup>	
CROSSVOLT <sup>TM</sup>	GlobalOptoisolator <sup>TM</sup>	POP <sup>TM</sup>	SuperSOT <sup>TM</sup> -3	
DenseTrench <sup>TM</sup>	GTO <sup>TM</sup>	Power247 <sup>TM</sup>	SuperSOT <sup>TM</sup> -6	
DOMET <sup>TM</sup>	HiSeC <sup>TM</sup>	PowerTrench <sup>®</sup>	SuperSOT <sup>TM</sup> -8	
EcoSPARK <sup>TM</sup>	ISOPLANAR <sup>TM</sup>	QFET <sup>TM</sup>	SyncFET <sup>TM</sup>	
E <sup>2</sup> CMOS <sup>TM</sup>	LittleFET <sup>TM</sup>	QST <sup>TM</sup>	TinyLogic <sup>TM</sup>	
EnSigna <sup>TM</sup>	MicroFET <sup>TM</sup>	QT Optoelectronics <sup>TM</sup>	TruTranslation <sup>TM</sup>	
FACT <sup>TM</sup>	MicroPak <sup>TM</sup>	Quiet Series <sup>TM</sup>	UHC <sup>TM</sup>	
FACT Quiet Series <sup>TM</sup>	MICROWIRE <sup>TM</sup>	SILENT SWITCHER <sup>®</sup>	UltraFET <sup>®</sup>	

STAR\*POWER is used under license

## DISCLAIMER

FAIRCHILD SEMICONDUCTOR RESERVES THE RIGHT TO MAKE CHANGES WITHOUT FURTHER NOTICE TO ANY PRODUCTS HEREIN TO IMPROVE RELIABILITY, FUNCTION OR DESIGN. FAIRCHILD DOES NOT ASSUME ANY LIABILITY ARISING OUT OF THE APPLICATION OR USE OF ANY PRODUCT OR CIRCUIT DESCRIBED HEREIN; NEITHER DOES IT CONVEY ANY LICENSE UNDER ITS PATENT RIGHTS, NOR THE RIGHTS OF OTHERS.

## LIFE SUPPORT POLICY

FAIRCHILD'S PRODUCTS ARE NOT AUTHORIZED FOR USE AS CRITICAL COMPONENTS IN LIFE SUPPORT DEVICES OR SYSTEMS WITHOUT THE EXPRESS WRITTEN APPROVAL OF FAIRCHILD SEMICONDUCTOR CORPORATION.

As used herein:

1. Life support devices or systems are devices or systems which, (a) are intended for surgical implant into the body, or (b) support or sustain life, or (c) whose failure to perform when properly used in accordance with instructions for use provided in the labeling, can be reasonably expected to result in significant injury to the user.
2. A critical component is any component of a life support device or system whose failure to perform can be reasonably expected to cause the failure of the life support device or system, or to affect its safety or effectiveness.

## PRODUCT STATUS DEFINITIONS

### Definition of Terms

Datasheet Identification	Product Status	Definition
Advance Information	Formative or In Design	This datasheet contains the design specifications for product development. Specifications may change in any manner without notice.
Preliminary	First Production	This datasheet contains preliminary data, and supplementary data will be published at a later date. Fairchild Semiconductor reserves the right to make changes at any time without notice in order to improve design.
No Identification Needed	Full Production	This datasheet contains final specifications. Fairchild Semiconductor reserves the right to make changes at any time without notice in order to improve design.
Obsolete	Not In Production	This datasheet contains specifications on a product that has been discontinued by Fairchild semiconductor. The datasheet is printed for reference information only.

ON Semiconductor and  are trademarks of Semiconductor Components Industries, LLC dba ON Semiconductor or its subsidiaries in the United States and/or other countries. ON Semiconductor owns the rights to a number of patents, trademarks, copyrights, trade secrets, and other intellectual property. A listing of ON Semiconductor's product/patent coverage may be accessed at [www.onsemi.com/site/pdf/Patent-Marking.pdf](http://www.onsemi.com/site/pdf/Patent-Marking.pdf). ON Semiconductor reserves the right to make changes without further notice to any products herein. ON Semiconductor makes no warranty, representation or guarantee regarding the suitability of its products for any particular purpose, nor does ON Semiconductor assume any liability arising out of the application or use of any product or circuit, and specifically disclaims any and all liability, including without limitation special, consequential or incidental damages. Buyer is responsible for its products and applications using ON Semiconductor products, including compliance with all laws, regulations and safety requirements or standards, regardless of any support or applications information provided by ON Semiconductor. "Typical" parameters which may be provided in ON Semiconductor data sheets and/or specifications can and do vary in different applications and actual performance may vary over time. All operating parameters, including "Typicals" must be validated for each customer application by customer's technical experts. ON Semiconductor does not convey any license under its patent rights nor the rights of others. ON Semiconductor products are not designed, intended, or authorized for use as a critical component in life support systems or any FDA Class 3 medical devices or medical devices with a same or similar classification in a foreign jurisdiction or any devices intended for implantation in the human body. Should Buyer purchase or use ON Semiconductor products for any such unintended or unauthorized application, Buyer shall indemnify and hold ON Semiconductor and its officers, employees, subsidiaries, affiliates, and distributors harmless against all claims, costs, damages, and expenses, and reasonable attorney fees arising out of, directly or indirectly, any claim of personal injury or death associated with such unintended or unauthorized use, even if such claim alleges that ON Semiconductor was negligent regarding the design or manufacture of the part. ON Semiconductor is an Equal Opportunity/Affirmative Action Employer. This literature is subject to all applicable copyright laws and is not for resale in any manner.

## PUBLICATION ORDERING INFORMATION

### LITERATURE FULFILLMENT:

Literature Distribution Center for ON Semiconductor  
19521 E. 32nd Pkwy, Aurora, Colorado 80011 USA  
**Phone:** 303-675-2175 or 800-344-3860 Toll Free USA/Canada  
**Fax:** 303-675-2176 or 800-344-3867 Toll Free USA/Canada  
**Email:** [orderlit@onsemi.com](mailto:orderlit@onsemi.com)

**N. American Technical Support:** 800-282-9855 Toll Free  
USA/Canada  
**Europe, Middle East and Africa Technical Support:**  
Phone: 421 33 790 2910  
**Japan Customer Focus Center**  
Phone: 81-3-5817-1050

**ON Semiconductor Website:** [www.onsemi.com](http://www.onsemi.com)  
**Order Literature:** <http://www.onsemi.com/orderlit>  
For additional information, please contact your local  
Sales Representative