

**Product number FA10299_OSS-RS**

Family	Rose	FWHM	7 degrees
Type	Assembly	Efficiency	90 %
LED	Golden Dragon+	cd/lm	29.600
Color	White	Gerber File	Available
Diameter	21.6 + 21.6 mm		
Height	13.9 mm		
Style	Square		
Optic Material	PC		
Holder Material	-		
Fastening	["tape"]		
Status	Production ready		

**Product number CA10561_OSS-2-RS**

Family	Rose	FWHM	7 degrees
Type	Assembly	Efficiency	-
LED	Golden Dragon+	cd/lm	35.500
Color	White	Gerber File	Available
Diameter	21.6 + 21.6 mm		
Height	13.9 mm		
Style	Square		
Optic Material	PMMA		
Holder Material	-		
Fastening	["tape"]		
Status	Production ready		

**Product number CA13613_G2-OSS-2-RS**

Family	Rose	FWHM	7 degrees
Type	Assembly	Efficiency	-
LED	Golden Dragon+	cd/lm	35.500
Color	White	Gerber File	Available
Diameter	21.6*21.6 mm		
Height	13.9 mm		
Style	Square		
Optic Material	PMMA		
Holder Material	-		
Fastening	-		
Status	Production ready		

**Product number FA10300_OSS-D**

Family	Rose	FWHM	11 degrees
Type	Assembly	Efficiency	87 %
LED	Golden Dragon+	cd/lm	12.700
Color	White	Gerber File	Available
Diameter	21.6 + 21.6 mm		
Height	13.9 mm		
Style	Square		
Optic Material	PC		
Holder Material	-		
Fastening	["tape"]		
Status	Production ready		

**Product number CA13609_G2-OSS-2-M**

Family	Rose	FWHM	11 degrees
Type	Assembly	Efficiency	90 %
LED	Golden Dragon+	cd/lm	14.780
Color	White	Gerber File	Available
Diameter	21.6*21.6 mm		
Height	13.9 mm		
Style	Square		
Optic Material	PMMA		
Holder Material	-		
Fastening	["tape"]		
Status	Production ready		

**Product number FA10327_OSS-SS**

Family	Rose	FWHM	12 degrees
Type	Assembly	Efficiency	93 %
LED	Golden Dragon+	cd/lm	13.150
Color	White	Gerber File	Available
Diameter	21.6 + 21.6 mm		
Height	13.9 mm		
Style	Square		
Optic Material	PC		
Holder Material	-		
Fastening	["tape"]		
Status	Production ready		

**Product number CA10560_OSS-2-SS**

Family	Rose	FWHM	12 degrees
Type	Assembly	Efficiency	92 %
LED	Golden Dragon+	cd/lm	16.000
Color	White	Gerber File	Available
Diameter	21.6 + 21.6 mm		
Height	13.9 mm		
Style	Square		
Optic Material	PMMA		
Holder Material	-		
Fastening	["tape"]		
Status	Production ready		

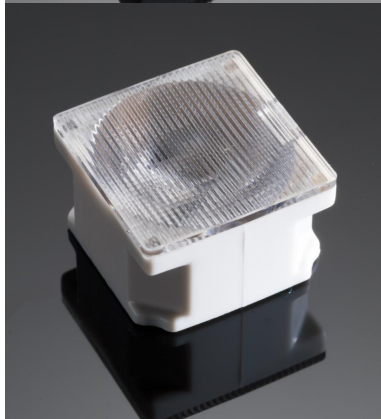
**Product number FA11145_OSS-O-90**

Family	Rose	FWHM	12+48 degrees
Type	Assembly	Efficiency	-
LED	Golden Dragon+	cd/lm	-
Color	White	Gerber File	Available
Diameter	21.6 + 21.6 mm		
Height	13.9 mm		
Style	Square		
Optic Material	PC		
Holder Material	-		
Fastening	["tape"]		
Status	Production ready		

Product number CA13612_G2-OSS-2-SS

Family	Rose	FWHM	12 degrees
Type	Assembly	Efficiency	92 %
LED	Golden Dragon+	cd/lm	16.000
Color	White	Gerber File	Available
Diameter	21.6*21.6 mm		
Height	13.9 mm		
Style	Square		
Optic Material	PMMA		
Holder Material	-		
Fastening	["tape"]		
Status	Production ready		

Product number CA10559_OSS-2-D

Family	Rose	FWHM	13 degrees
Type	Assembly	Efficiency	-
LED	Golden Dragon+	cd/lm	11.210
Color	White	Gerber File	Available
Diameter	21.6 + 21.6 mm		
Height	13.9 mm		
Style	Square		
Optic Material	PMMA		
Holder Material	-		
Fastening	["tape"]		
Status	Production ready		

Product number CA10572_OSS-2-O

Family	Rose	FWHM	13+37 degrees
Type	Assembly	Efficiency	-
LED	Golden Dragon+	cd/lm	4.100
Color	White	Gerber File	Available
Diameter	21.6 + 21.6 mm		
Height	13.9 mm		
Style	Square		
Optic Material	PMMA		
Holder Material	-		
Fastening	["tape"]		
Status	Production ready		

Product number CA13611_G2-OSS-2-D

Family	Rose	FWHM	13 degrees
Type	Assembly	Efficiency	-
LED	Golden Dragon+	cd/lm	11.210
Color	White	Gerber File	Available
Diameter	21.6*21.6 mm		
Height	13.9 mm		
Style	Square		
Optic Material	PMMA		
Holder Material	-		
Fastening	["tape"]		
Status	Production ready		

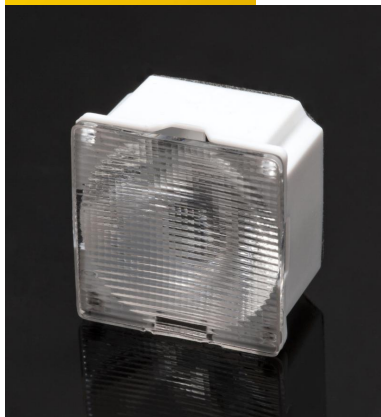
**Product number CA13615_G2-OSS-2-O**

Family	Rose	FWHM	13+37 degrees
Type	Assembly	Efficiency	-
LED	Golden Dragon+	cd/lm	4.100
Color	White	Gerber File	Available
Diameter	21.6*21.6 mm		
Height	13.9 mm		
Style	Square		
Optic Material	PMMA		
Holder Material	-		
Fastening	["tape"]		
Status	Production ready		

**Product number CA10569_OSS-2-M**

Family	Rose	FWHM	24 degrees
Type	Assembly	Efficiency	-
LED	Golden Dragon+	cd/lm	4.360
Color	White	Gerber File	Available
Diameter	21.6 + 21.6 mm		
Height	13.9 mm		
Style	Square		
Optic Material	PMMA		
Holder Material	-		
Fastening	["tape"]		
Status	Production ready		

**Product number CA13614_G2-OSS-2-M**

Family	Rose	FWHM	26 degrees
Type	Assembly	Efficiency	88 %
LED	Golden Dragon+	cd/lm	4.570
Color	White	Gerber File	Available
Diameter	21.6*21.6 mm		
Height	13.9 mm		
Style	Square		
Optic Material	PMMA		
Holder Material	-		
Fastening	["tape"]		
Status	Production ready		

**Product number FA10301_OSS-M**

Family	Rose	FWHM	30 degrees
Type	Assembly	Efficiency	87 %
LED	Golden Dragon+	cd/lm	2.700
Color	White	Gerber File	Available
Diameter	21.6 + 21.6 mm		
Height	13.9 mm		
Style	Square		
Optic Material	PC		
Holder Material	-		
Fastening	["tape"]		
Status	Production ready		

**Product number FA10302_OSS-O**

Family	Rose	FWHM	42+11 degrees
Type	Assembly	Efficiency	86 %
LED	Golden Dragon+	cd/lm	4.200
Color	White	Gerber File	Available
Diameter	21.6 + 21.6 mm		
Height	13.9 mm		
Style	Square		
Optic Material	PC		
Holder Material	-		
Fastening	["tape"]		
Status	Production ready		

**Product number FA10342_OSS-W**

Family	Rose	FWHM	48 degrees
Type	Assembly	Efficiency	84 %
LED	Golden Dragon+	cd/lm	1.000
Color	White	Gerber File	Available
Diameter	21.6 + 21.6 mm		
Height	13.9 mm		
Style	Square		
Optic Material	PC		
Holder Material	-		
Fastening	["tape"]		
Status	Production ready		

**Product number CA12081_OSS-2-WWW**

Family	Rose	FWHM	80 degrees
Type	Assembly	Efficiency	-
LED	Golden Dragon+	cd/lm	-
Color	White	Gerber File	Available
Diameter	21.6 + 21.6 mm		
Height	13.9 mm		
Style	Square		
Optic Material	PMMA		
Holder Material	-		
Fastening	["tape"]		
Status	Production ready		

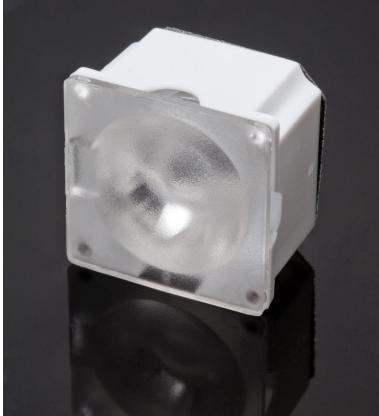
**Product number CA13617_G2-OSS-2-WWW**

Family	Rose	FWHM	80 degrees
Type	Assembly	Efficiency	-
LED	Golden Dragon+	cd/lm	-
Color	White	Gerber File	Available
Diameter	21.6*21.6 mm		
Height	13.9 mm		
Style	Square		
Optic Material	PMMA		
Holder Material	-		
Fastening	["tape"]		
Status	Production ready		



PRODUCT DATASHEET

Rose series

last update 9/5/2014

NOTE: The typical divergence will be changed by different color, chip size and chip position tolerance. The typical total divergence is the full angle measured where the luminous intensity is half of the peak value.



PRODUCT DATASHEET

Rose series

last update 9/5/2014

GENERAL INFORMATION

- Product series especially designed & optimized for Golden Dragon+ series of LEDs.
- Special care taken to make light distribution as uniform as possible.
- Lens material optical grade PMMA with high UV and temperature resistance. Allows use of high current and temperature conditions.

Please find more information about used material from below:

http://ledil.fi/sites/default/files/Documents/Technical/Material/PMMA%20N%20UL94_Yellow%20Card.pdf

<http://ledil.fi/sites/default/files/Documents/Technical/Material/PMMA%20N%20PLEXIGLAS-Datasheet.pdf>

- Lens material optical grade PC with high UV and temperature resistance (120 degrees of Celcius / 248 degrees of Fahrenheit). Allows use of high current and temperature conditions.

Please find more information about used materials from below:

http://ledil.fi/sites/default/files/Documents/Technical/Material/PC%20Makrolon%202400_2407_2456_2458-UL.pdf

Relative intensity of CA13609_G2-OSS-2-M_(GD+)

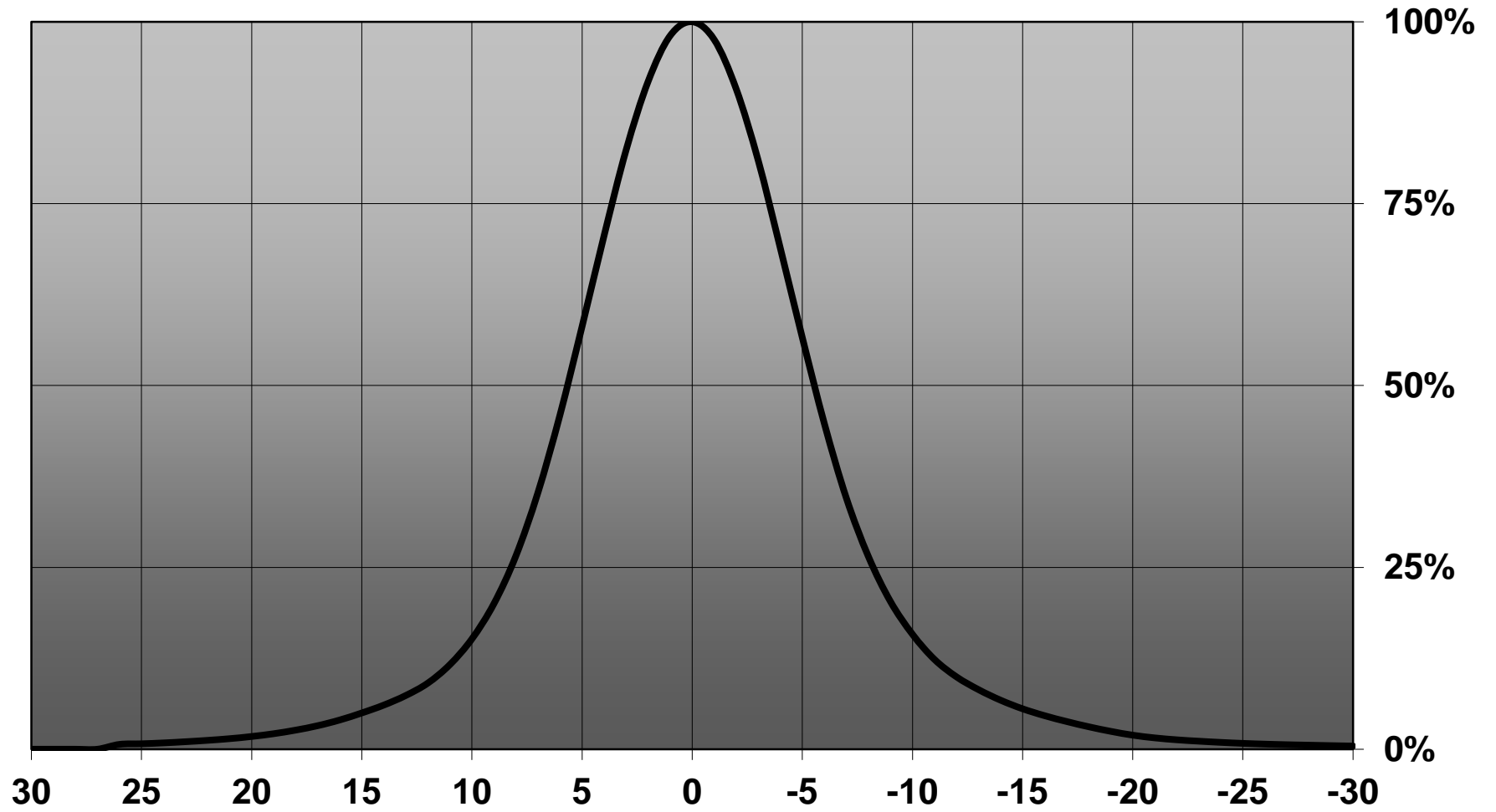

Relative intensity of CA13614_G2-OSS-2-M_(GD+)

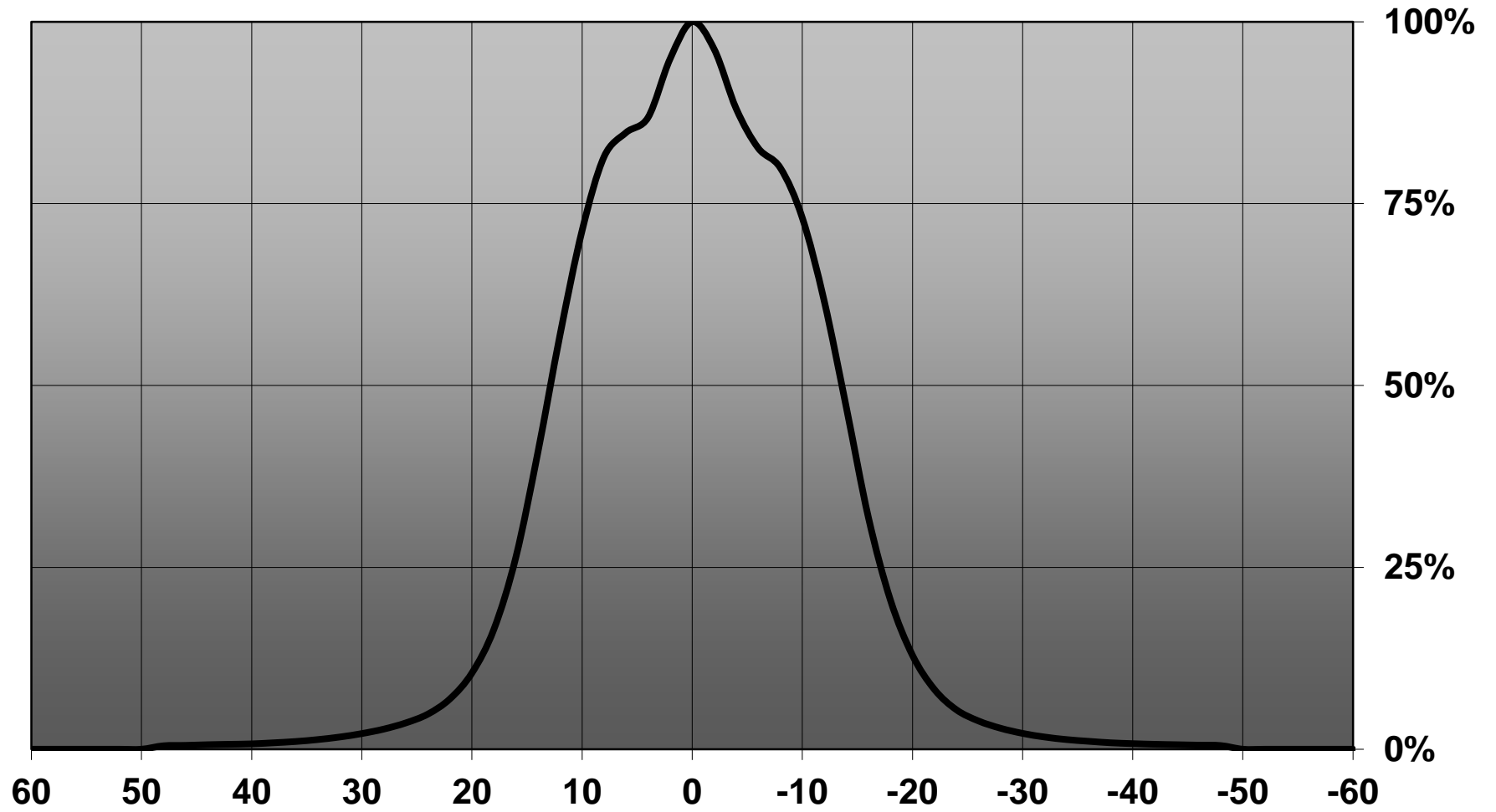

Ledil Oy FA10299_OSS-RS FA10299_OSS-RS / LDC (Linear)

Luminaire: Ledil Oy FA10299_OSS-RS FA10299_OSS-RS

Lamps: 1 x Osram-os Golden Dragon+

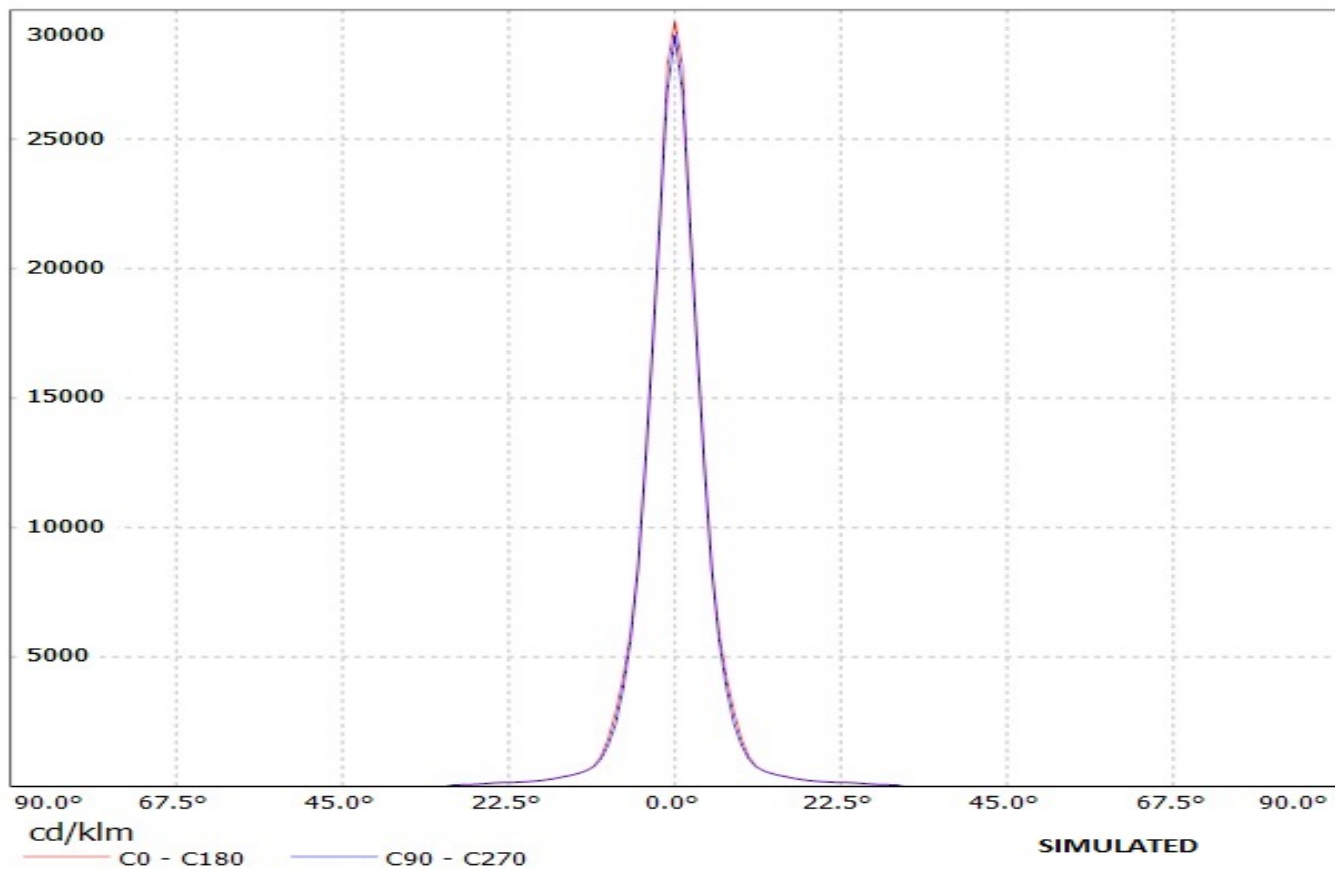

Ledil oy CA10561_OSS-2-RS (Golden Dragon+) LOR=92% / LDC (Linear)

Luminaire: Ledil oy CA10561_OSS-2-RS (Golden Dragon+) LOR=92%
Lamps: 1 x Osram Golden Dragon+ 67lm @ 250mA

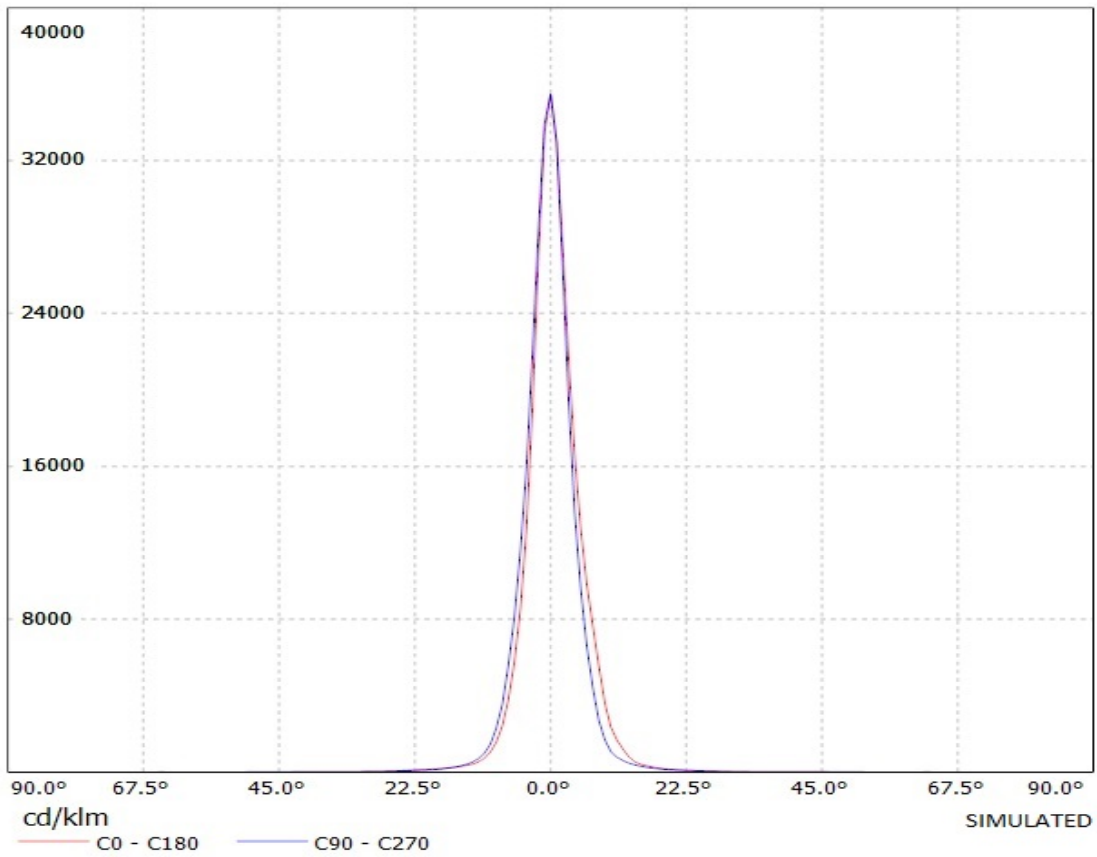

Ledil Oy FA10300_OSS-D FA10300_OSS-D / LDC (Linear)

Luminaire: Ledil Oy FA10300_OSS-D FA10300_OSS-D
Lamps: 1 x OSRAM-OS GOLDEN DRAGON+ (white)

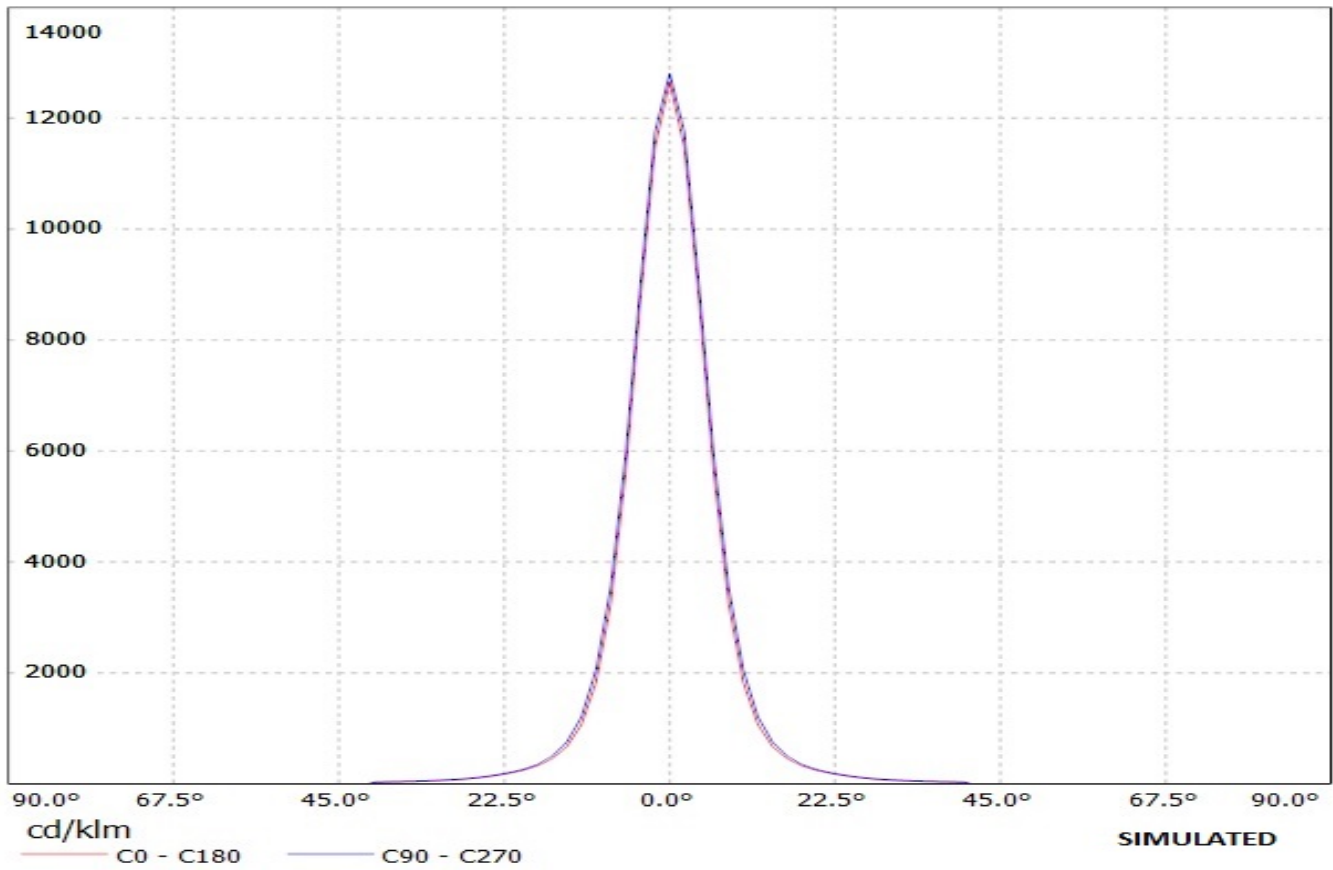

Ledil Oy FA10327_OSS-SS FA10327_OSS-SS / LDC (Linear)

Luminaire: Ledil Oy FA10327_OSS-SS FA10327_OSS-SS
Lamps: 1 x Osram-os Golden Dragon+

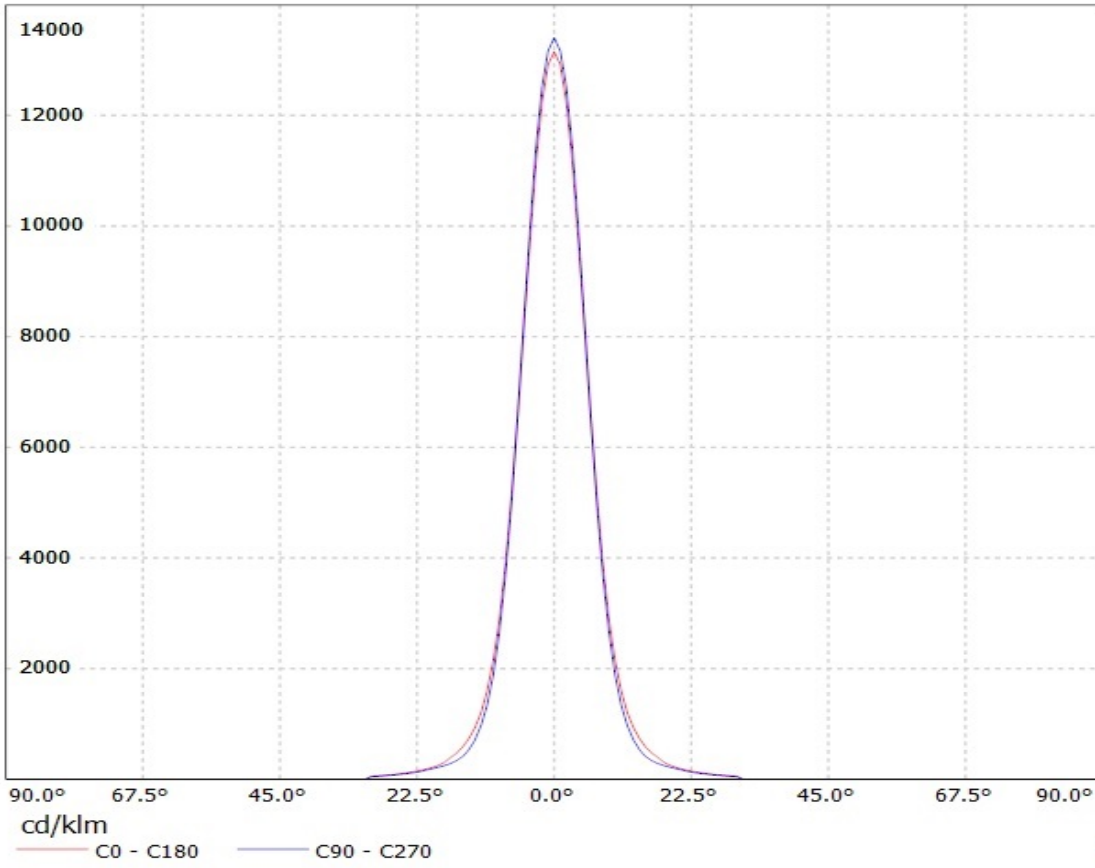

Ledil oy CA10559_OSS-2-D (Golden Dragon+) LOR=92% / LDC (Linear)

Luminaire: Ledil oy CA10559_OSS-2-D (Golden Dragon+) LOR=92%
Lamps: 1 x Osram Golden Dragon+ 67lm @ 250mA

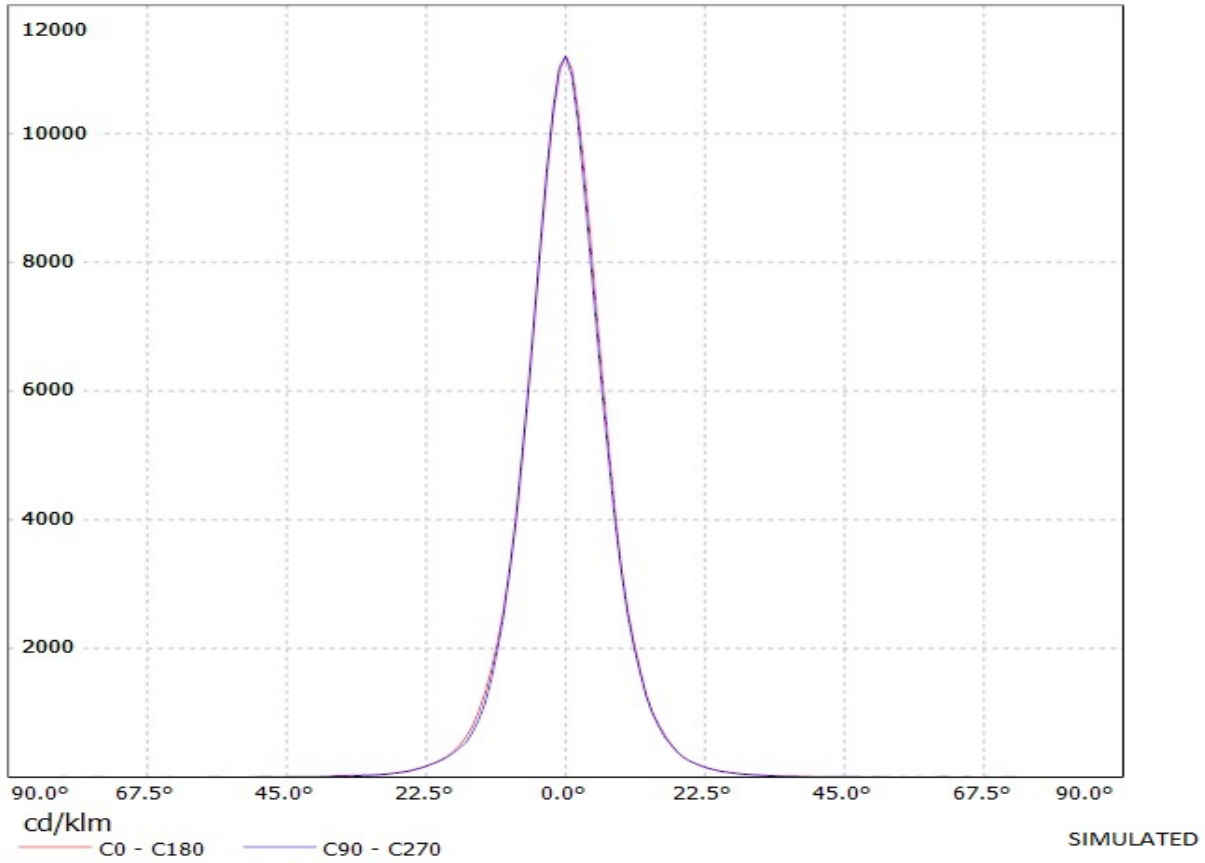

Ledil Oy CA10572-OSS-2-O LOR=93% / LDC (Linear)

Luminaire: Ledil Oy CA10572-OSS-2-O LOR=93%
Lamps: 1 x Golden dragon plus 80lm 250mA

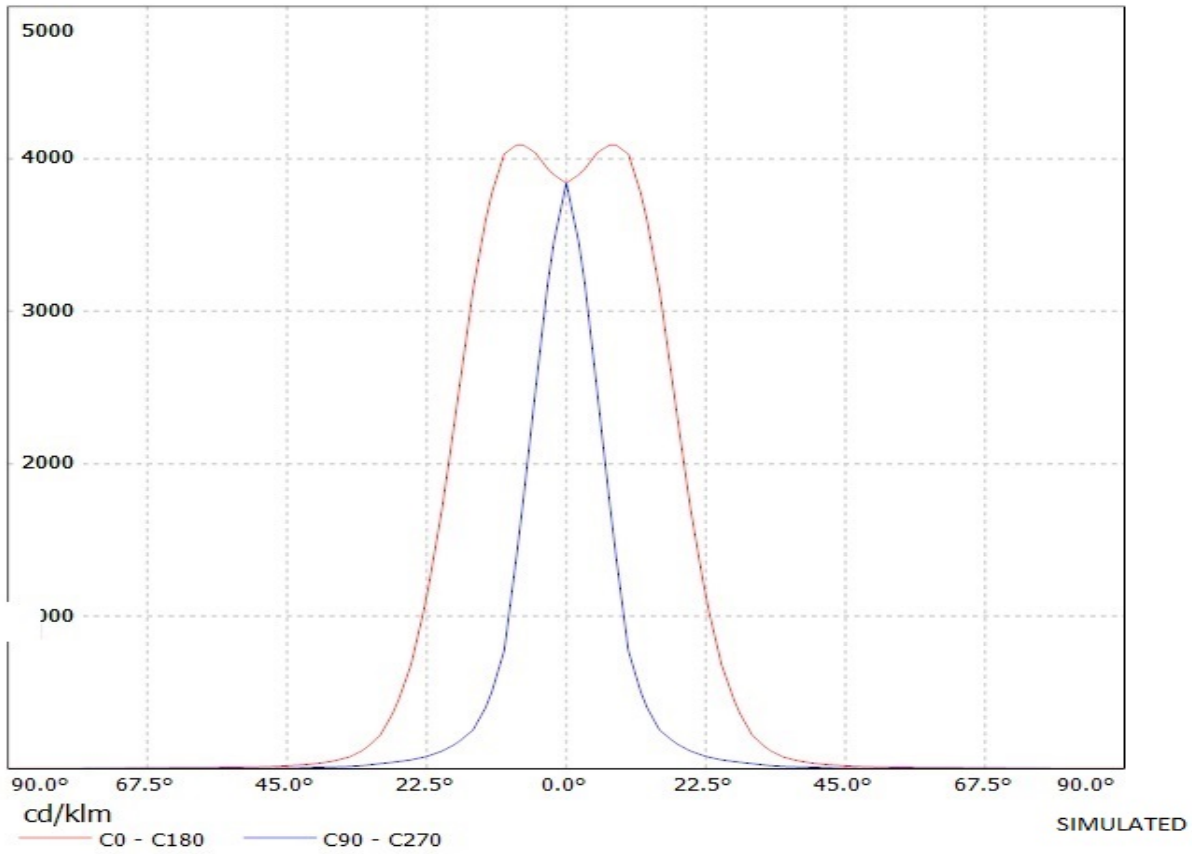

Ledil Oy CA10569_OSS-2-M-GD+_SIMULATED / LDC (Linear)

Luminaire: Ledil Oy CA10569_OSS-2-M-GD+_SIMULATED
Lamps: 1 x Golden Dragon Plus 100lm

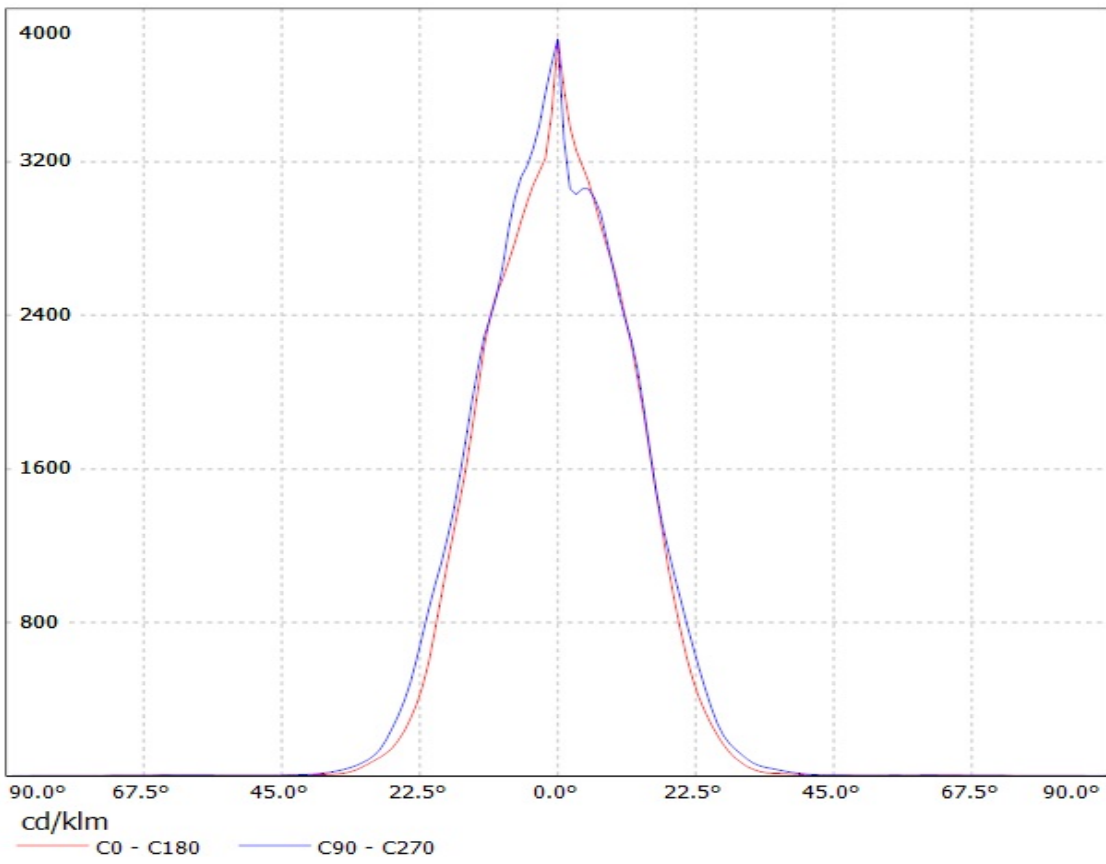

Ledil Oy FA10301_OSS-M FA10301_OSS-M / LDC (Linear)

Luminaire: Ledil Oy FA10301_OSS-M FA10301_OSS-M
Lamps: 1 x Osram-os Golden Dragon+

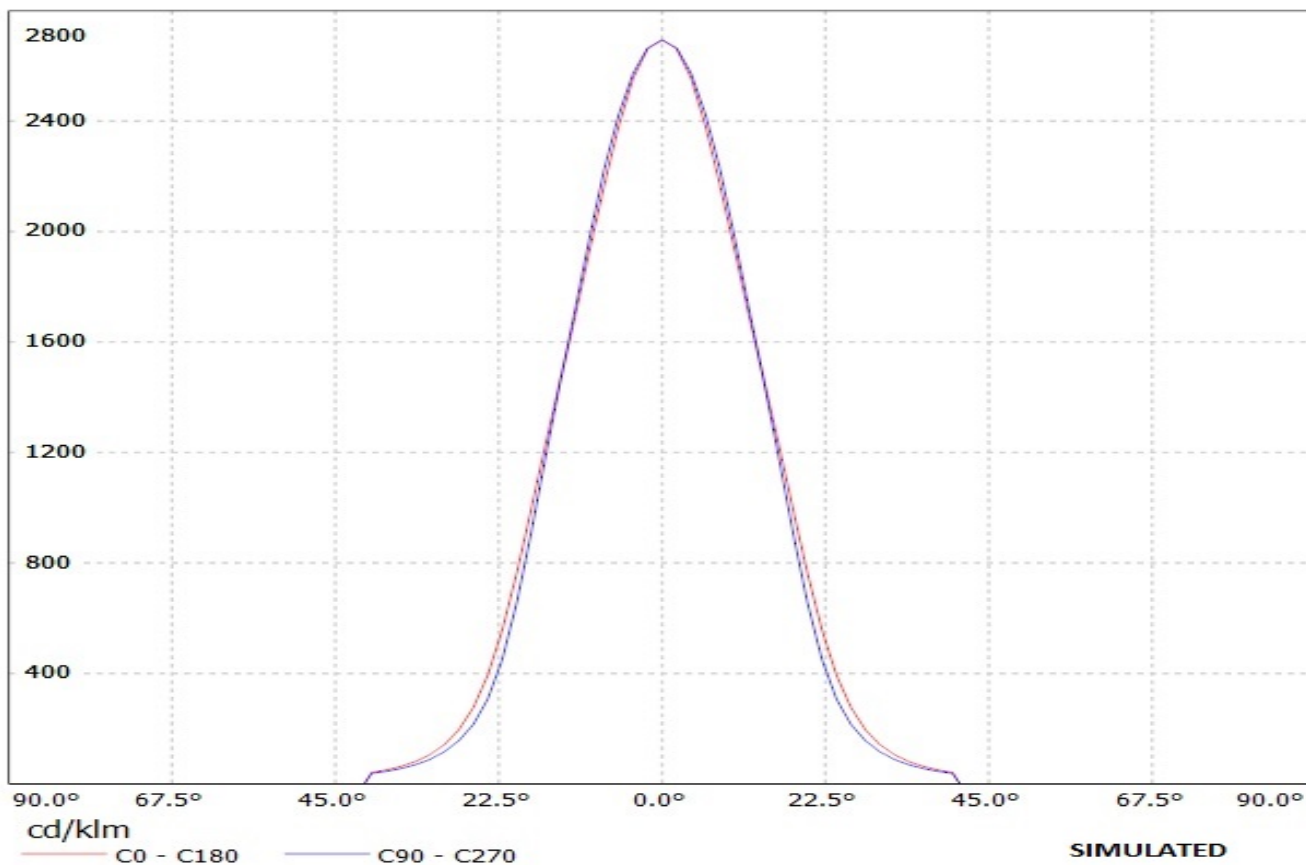

Ledil Oy FA10302_OSS-O FA10302_OSS-O / LDC (Linear)

Luminaire: Ledil Oy FA10302_OSS-O FA10302_OSS-O
Lamps: 1 x OSRAM-OS GOLDEN DRAGON+ (white)

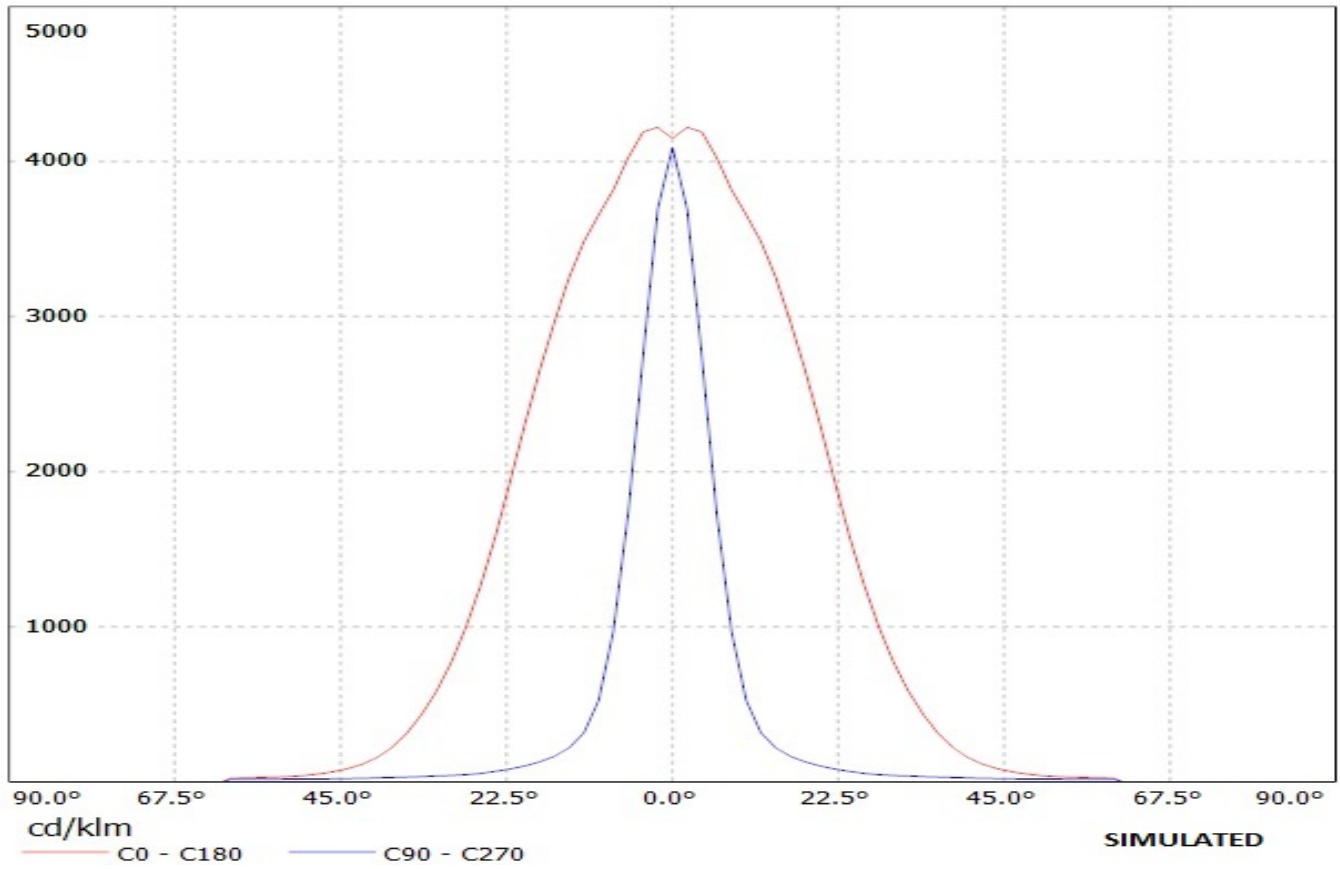

Ledil Oy FA10299_OSS-RS FA10299_OSS-RS / LDC (Polar)

Luminaire: Ledil Oy FA10299_OSS-RS FA10299_OSS-RS
Lamps: 1 x Osram-os Golden Dragon+

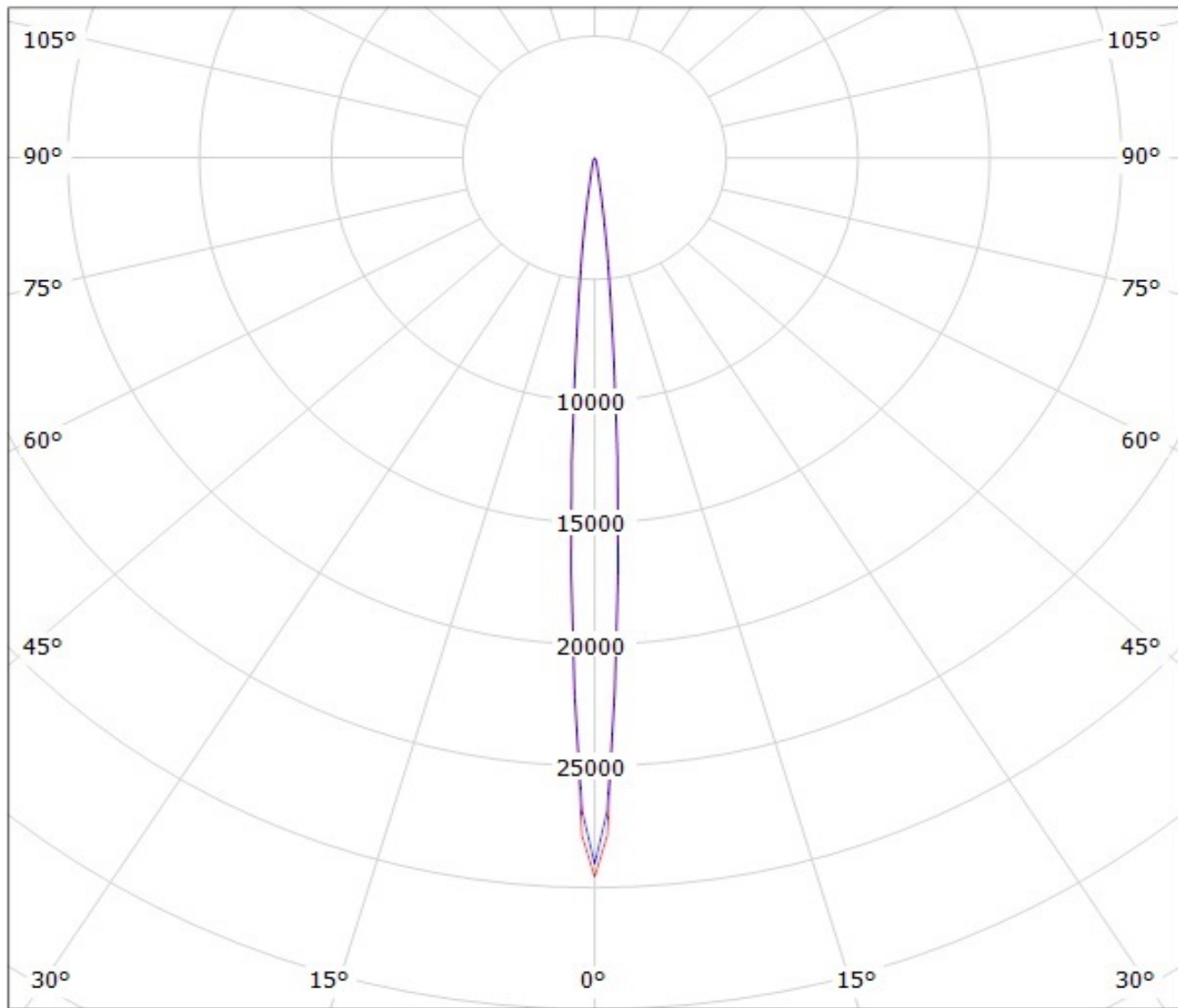

cd/klm

— C0 - C180

— C90 - C270

SIMULATED

Ledil oy CA10561_OSS-2-RS (Golden Dragon+) LOR=92% / LDC (Polar)

Luminaire: Ledil oy CA10561_OSS-2-RS (Golden Dragon+) LOR=92%
Lamps: 1 x Osram Golden Dragon+ 67lm @ 250mA

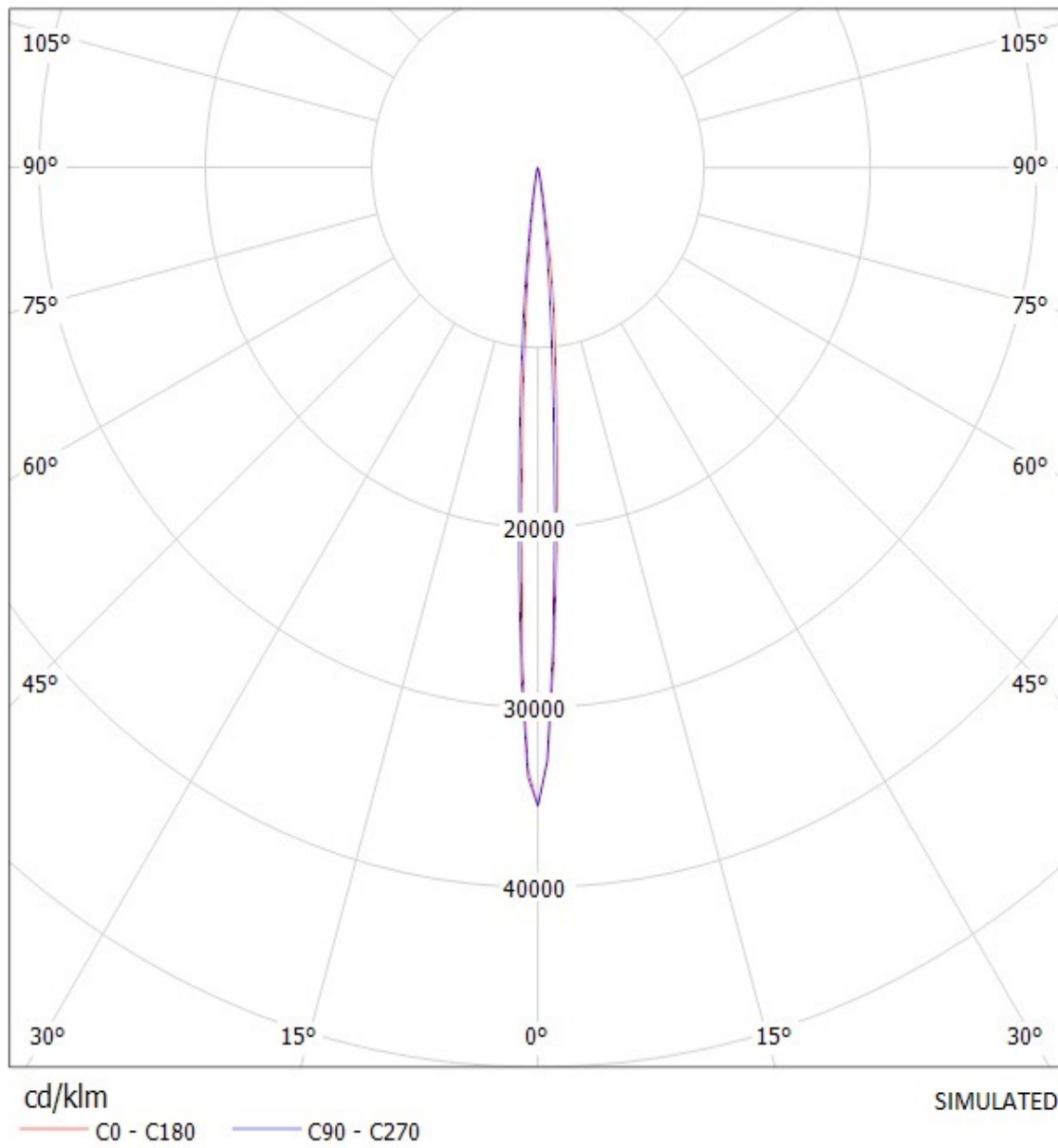

Ledil Oy FA10300_OSS-D FA10300_OSS-D / LDC (Polar)

Luminaire: Ledil Oy FA10300_OSS-D FA10300_OSS-D

Lamps: 1 x OSRAM-OS GOLDEN DRAGON+ (white)

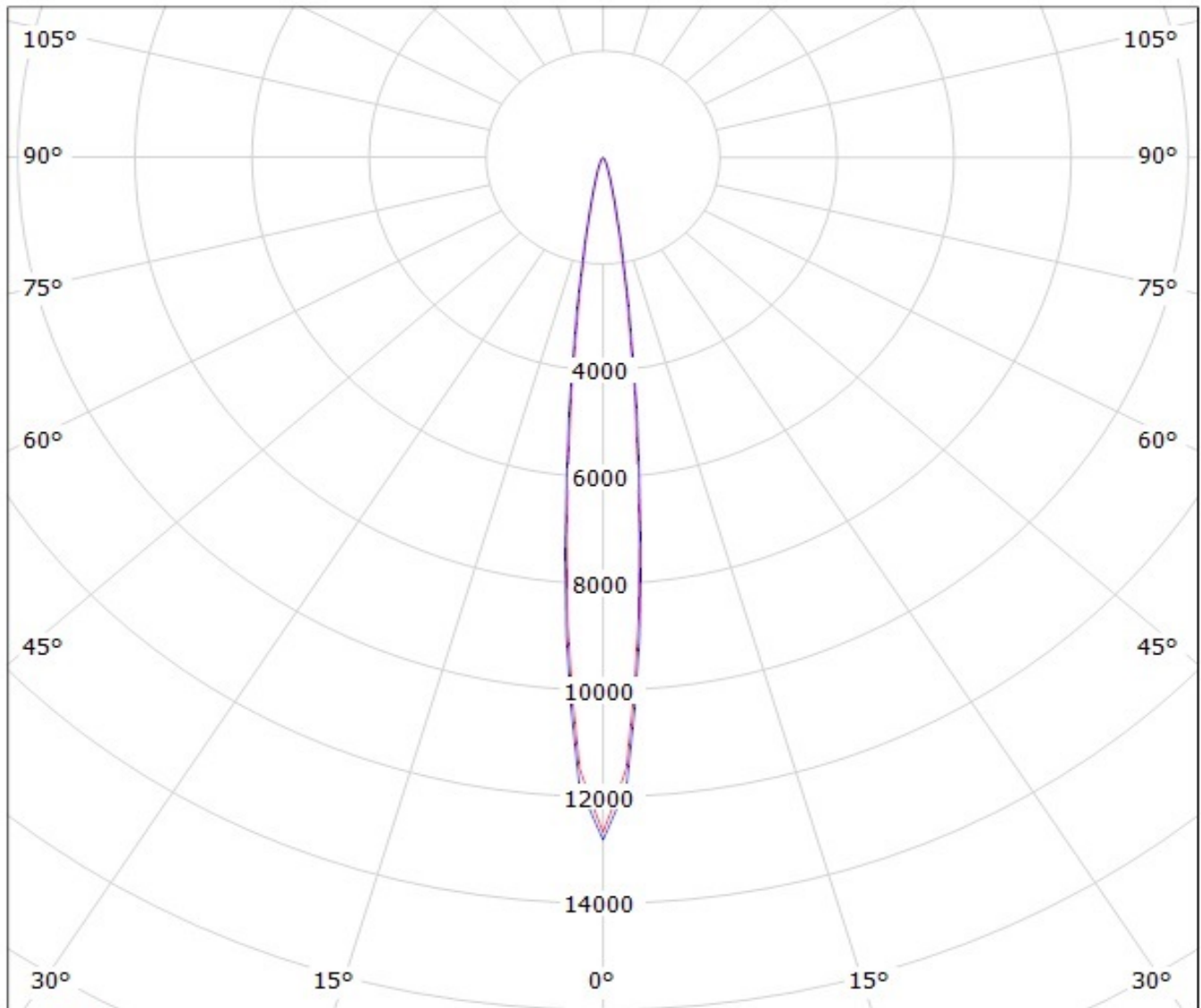

cd/klm

— C0 - C180

— C90 - C270

SIMULATED

Ledil Oy FA10327_OSS-SS FA10327_OSS-SS / LDC (Polar)

Luminaire: Ledil Oy FA10327_OSS-SS FA10327_OSS-SS

Lamps: 1 x Osram-os Golden Dragon+

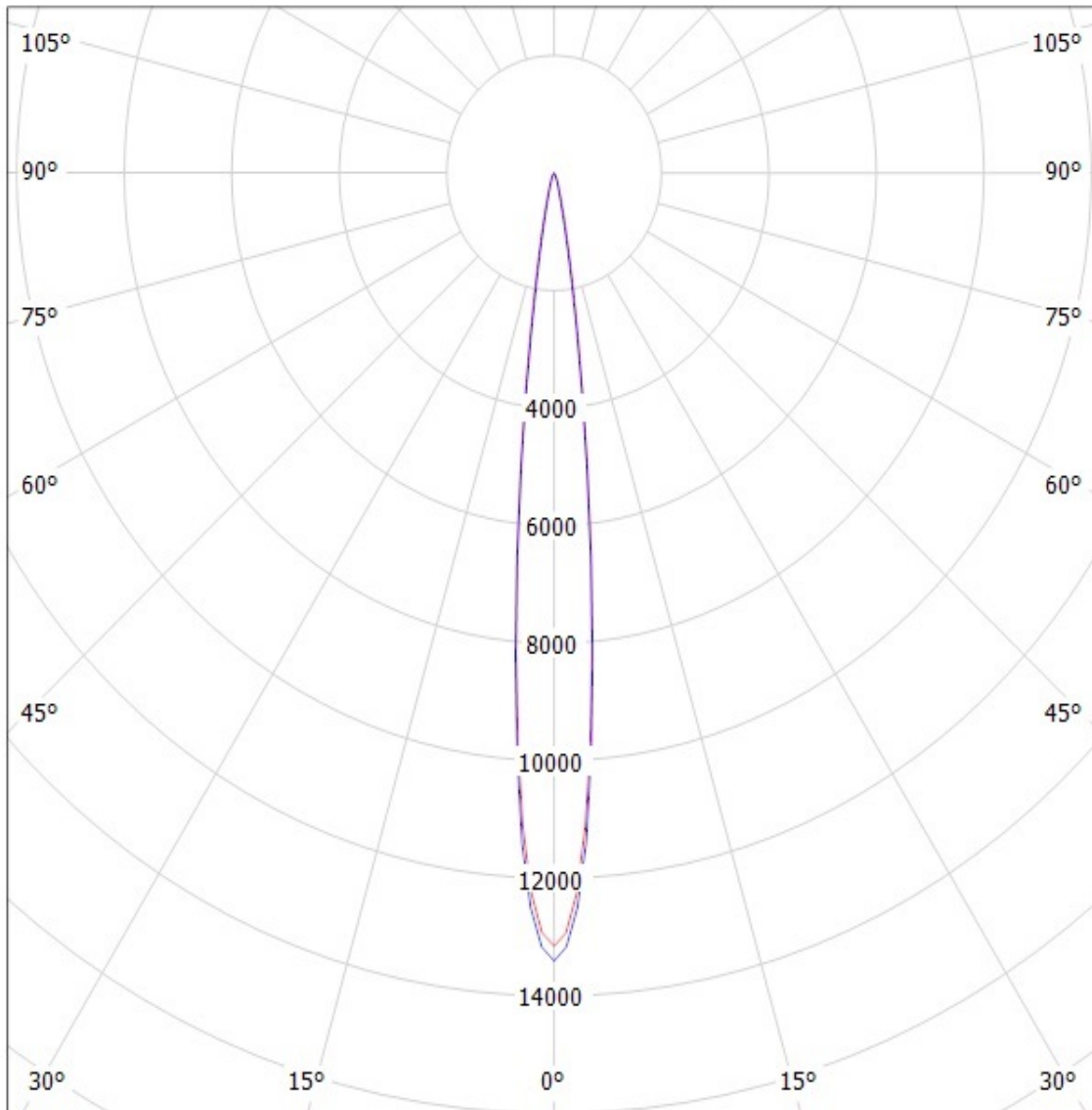

cd/klm

— C0 - C180 — C90 - C270

SIMULATED

Ledil oy CA10559_OSS-2-D (Golden Dragon+) LOR=92% / LDC (Polar)

Luminaire: Ledil oy CA10559_OSS-2-D (Golden Dragon+) LOR=92%

Lamps: 1 x Osram Golden Dragon+ 67lm @ 250mA

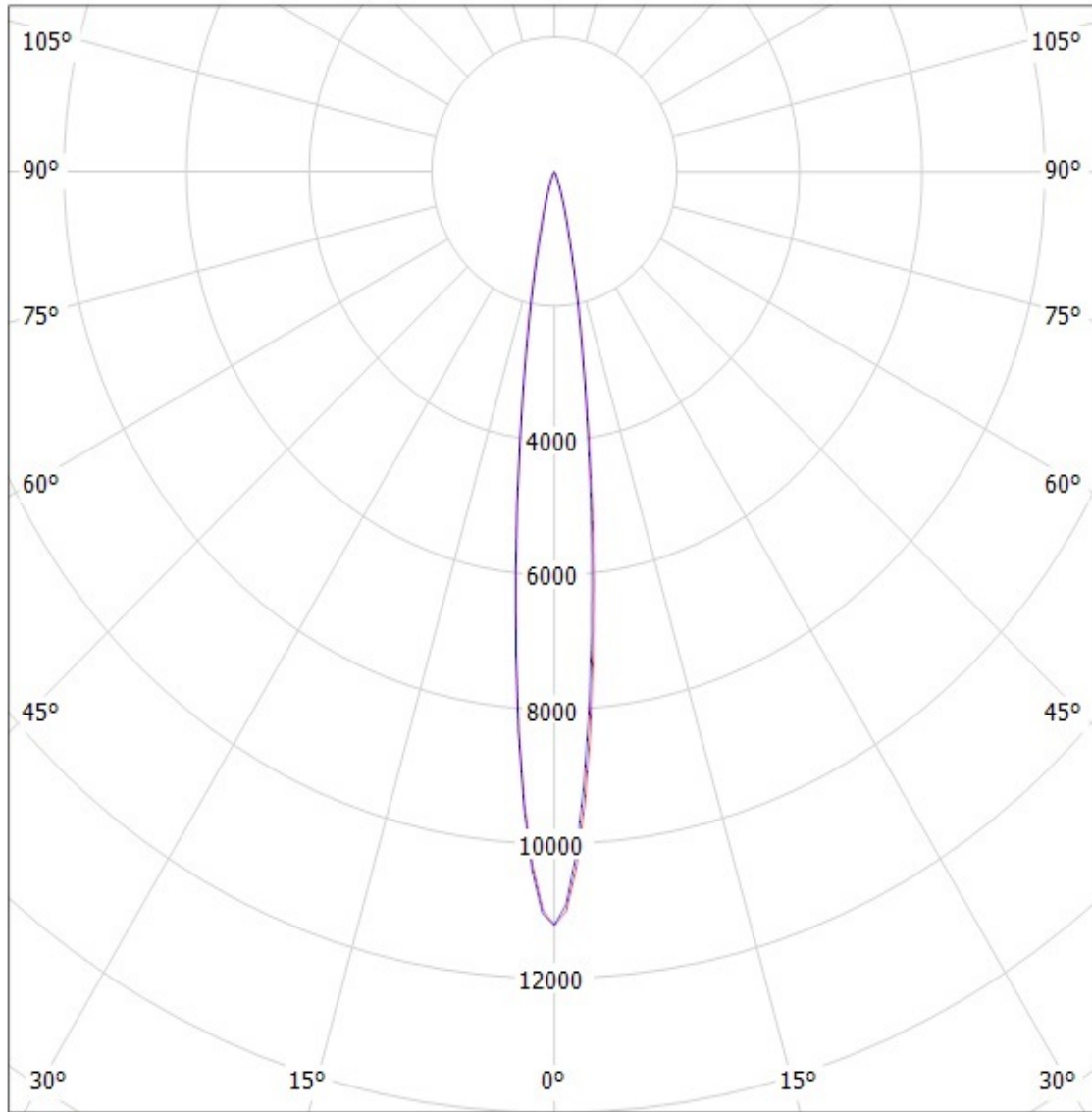

cd/klm

SIMULATED

— C0 - C180 — C90 - C270

Ledil Oy CA10572-OSS-2-O LOR=93% / LDC (Polar)

Luminaire: Ledil Oy CA10572-OSS-2-O LOR=93%

Lamps: 1 x Golden dragon plus 80lm 250mA

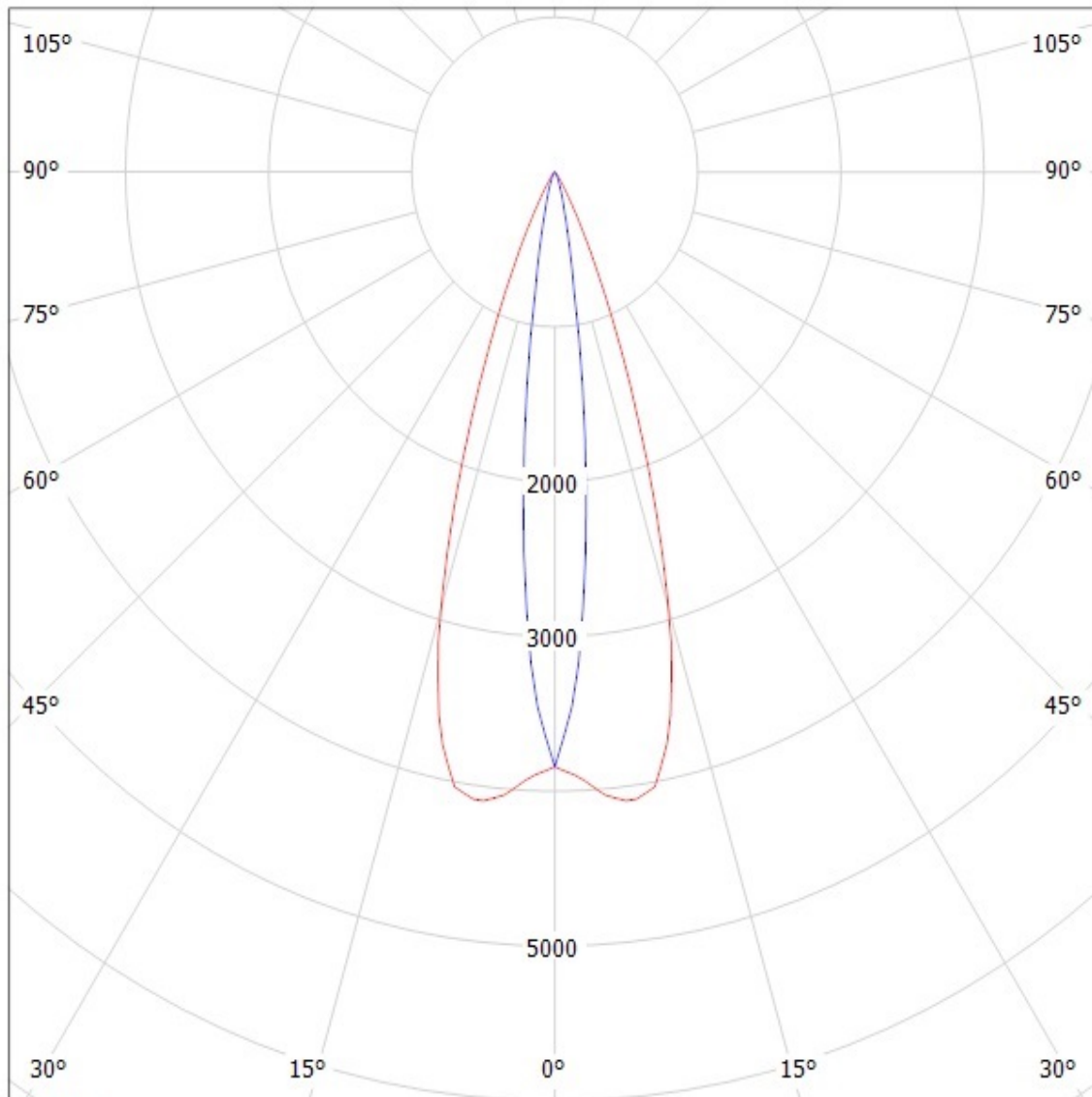

cd/klm

— C0 - C180

— C90 - C270

SIMULATED

Ledil Oy CA10569_OSS-2-M-GD+_SIMULATED / LDC (Polar)

Luminaire: Ledil Oy CA10569_OSS-2-M-GD+_SIMULATED

Lamps: 1 x Golden Dragon Plus 100lm

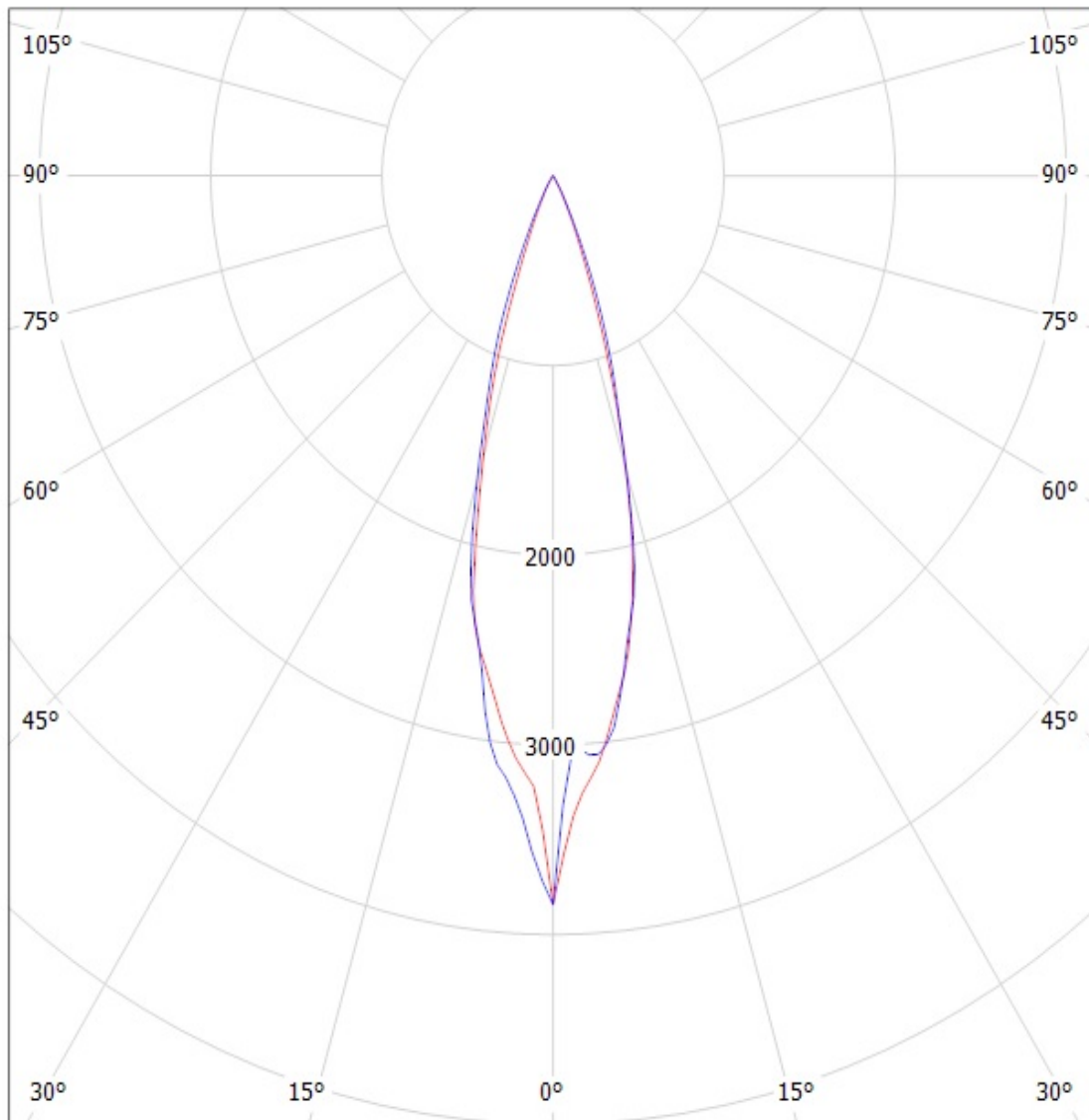

cd/klm

— C0 - C180

— C90 - C270

Ledil Oy FA10301_OSS-M FA10301_OSS-M / LDC (Polar)

Luminaire: Ledil Oy FA10301_OSS-M FA10301_OSS-M

Lamps: 1 x Osram-os Golden Dragon+

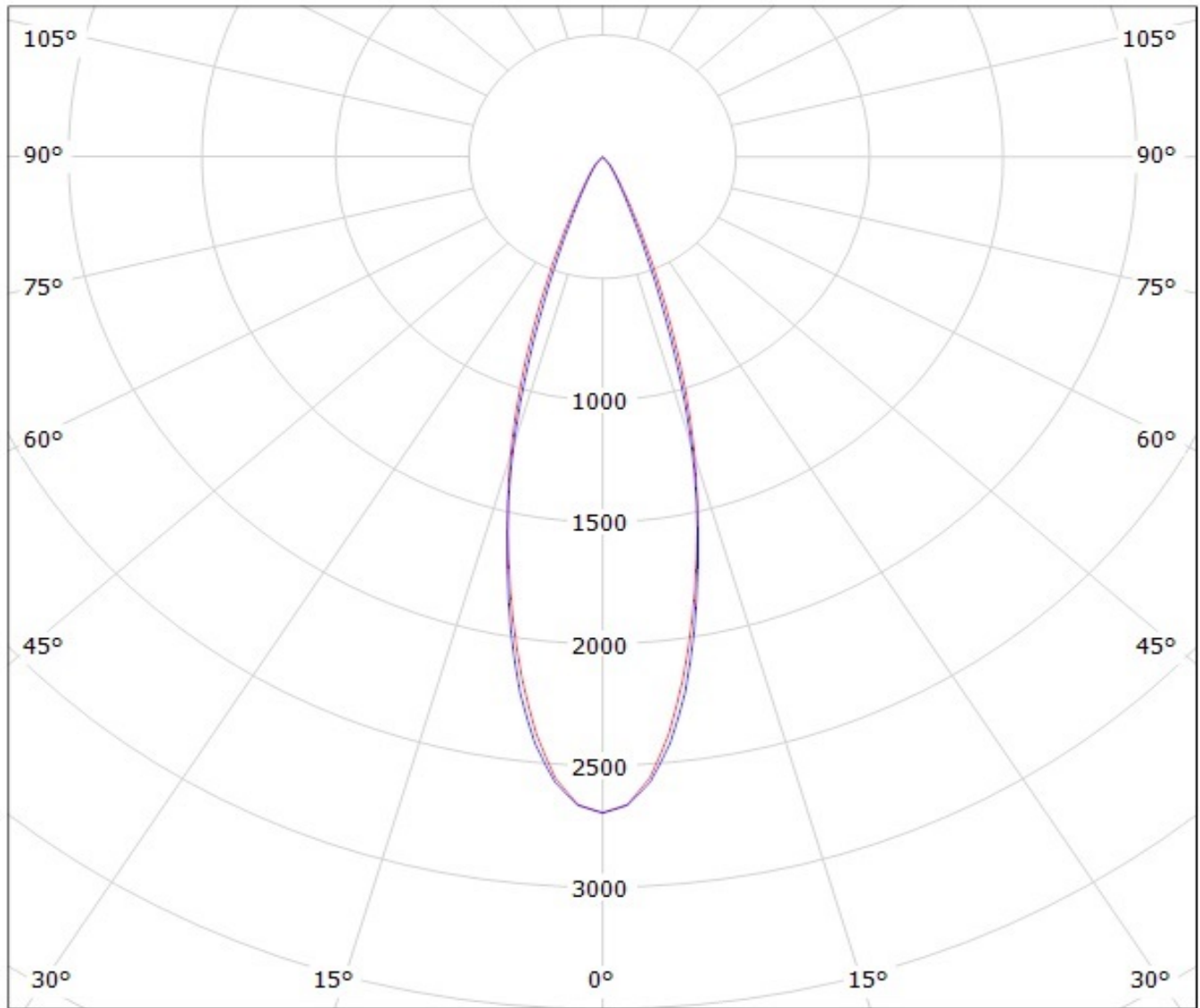

cd/klm

— C0 - C180

— C90 - C270

SIMULATED

Ledil Oy FA10302_OSS-O FA10302_OSS-O / LDC (Polar)

Luminaire: Ledil Oy FA10302_OSS-O FA10302_OSS-O
Lamps: 1 x OSRAM-OS GOLDEN DRAGON+ (white)

