

MIRELLA-G2-W

~35° wide beam. Compatible with LEDiL HEKLA.

TECHNICAL SPECIFICATIONS:

Dimensions	Ø 49.9 mm
Height	22.6 mm
Fastening	socket
ROHS compliant	yes ⓘ

MATERIAL SPECIFICATIONS:

Component	Type	Material	Colour	Finish	Coating
MIRELLA-G2-W	Reflector	PC	metal		

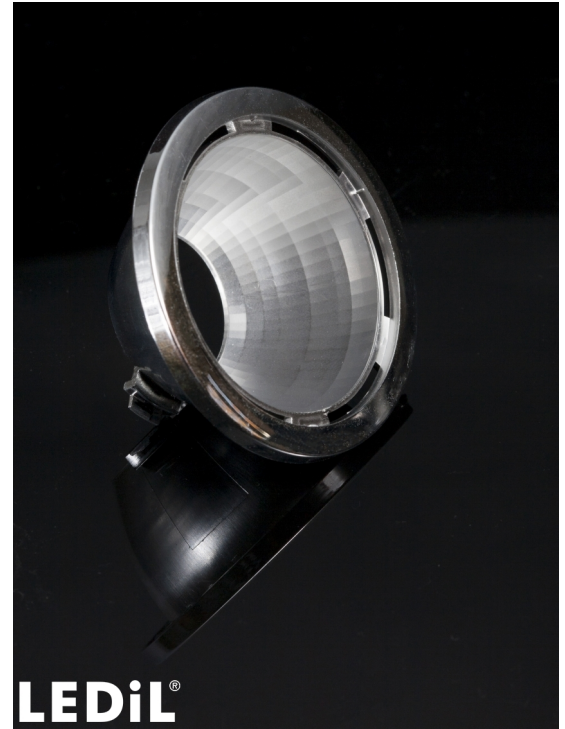

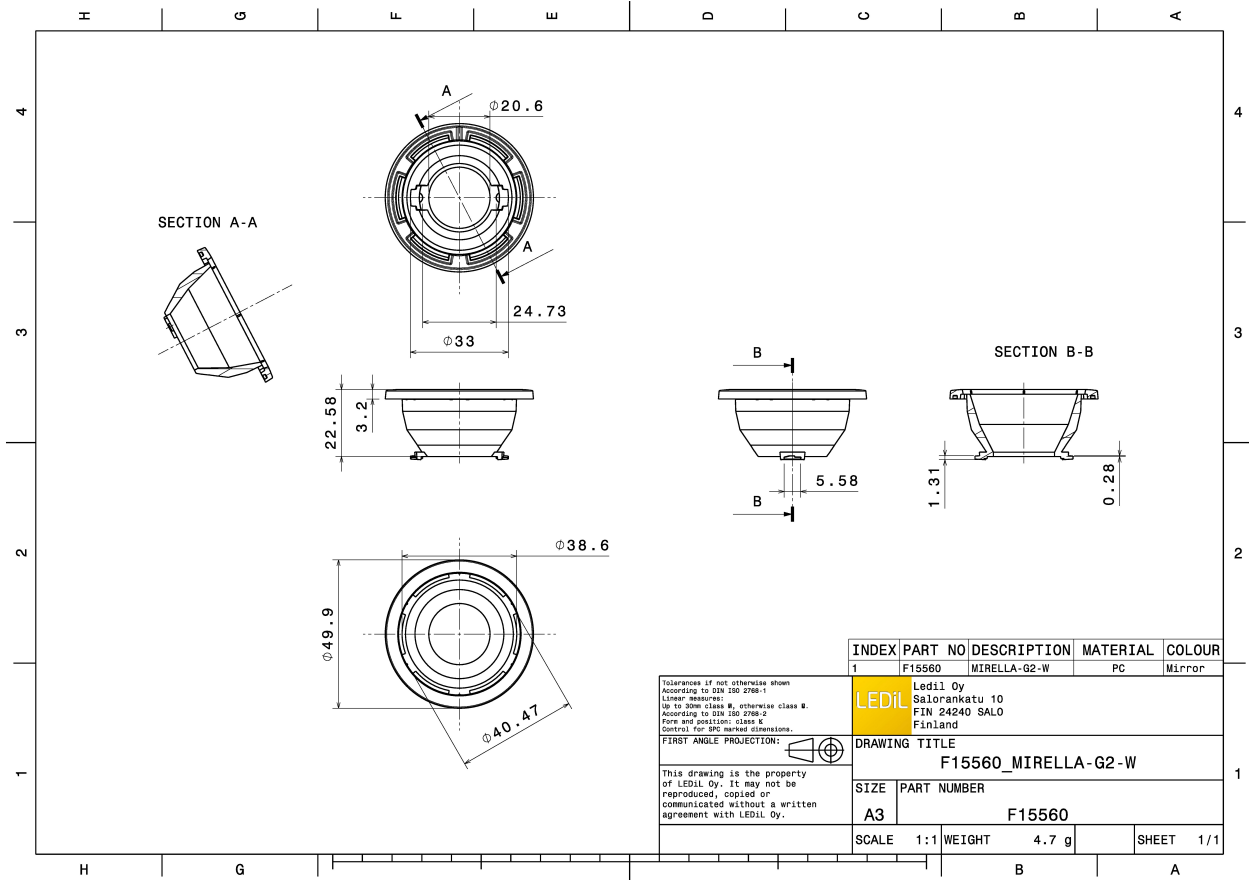

ORDERING INFORMATION:

Component	Qty in box	MOQ	MPQ	Box weight (kg)
F15560_MIRELLA-G2-W » Box size: 480 x 280 x 300 mm	336		28	3.3





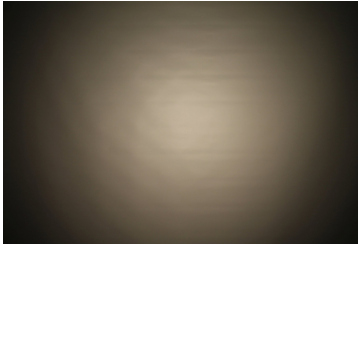
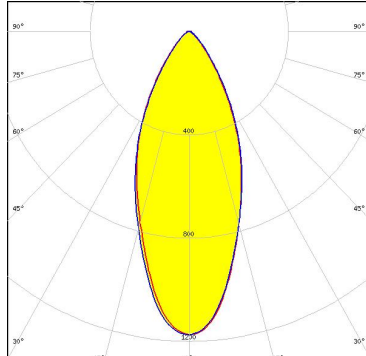

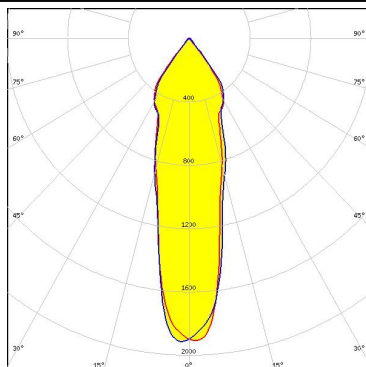
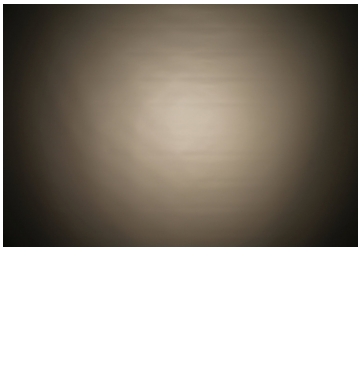
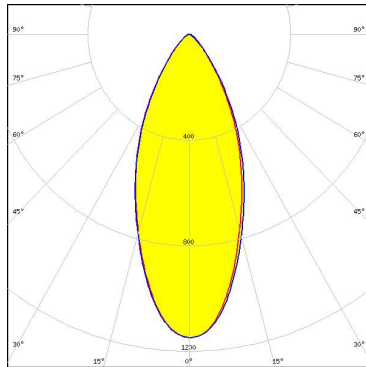
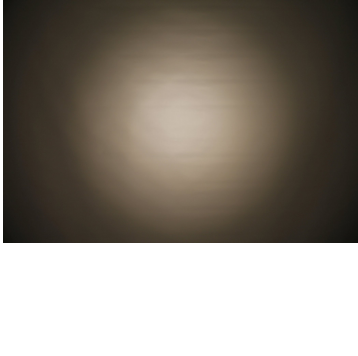
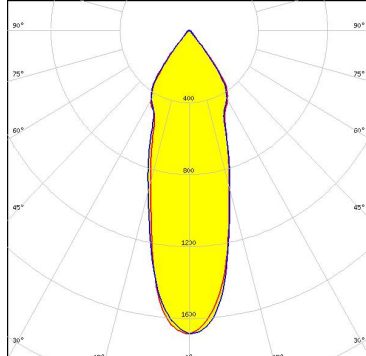
See also our general installation guide: www.ledil.com/installation_guide



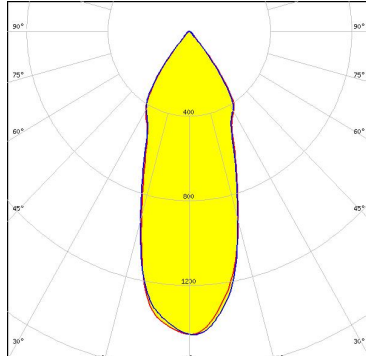

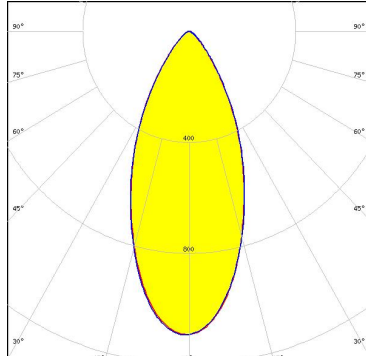
PHOTOMETRIC DATA (MEASURED):

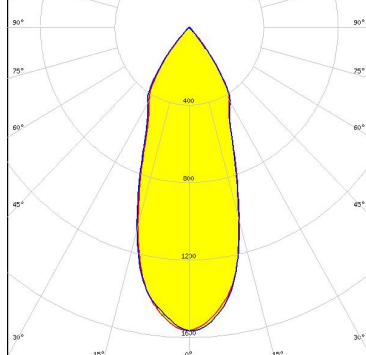
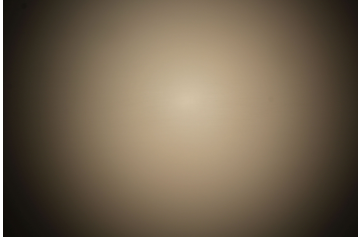
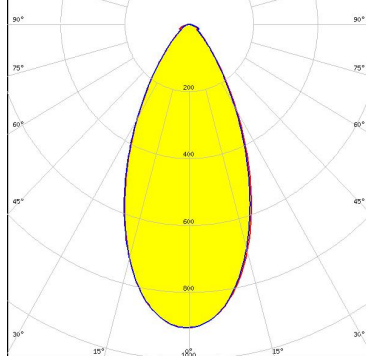
<p>bridgelux.</p> <p>LED V4 HD FWHM 42.0° Efficiency 80 % Peak intensity 1.2 cd/lm LEDs/each optic 1 Light colour White Required components: F15253_HEKLA-SOCKET-A C13723_MIRELLA-RZL</p>		
<p>bridgelux.</p> <p>LED V4 HD FWHM 26.0° Efficiency 89 % Peak intensity 1.9 cd/lm LEDs/each optic 1 Light colour White Required components: F15253_HEKLA-SOCKET-A</p>		
<p>bridgelux.</p> <p>LED V6 HD FWHM 43.0° Efficiency 80 % Peak intensity 1.2 cd/lm LEDs/each optic 1 Light colour White Required components: F15255_HEKLA-SOCKET-C C13723_MIRELLA-RZL</p>		
<p>bridgelux.</p> <p>LED V6 HD FWHM 32.0° Efficiency 88 % Peak intensity 1.7 cd/lm LEDs/each optic 1 Light colour White Required components: F15255_HEKLA-SOCKET-C</p>		



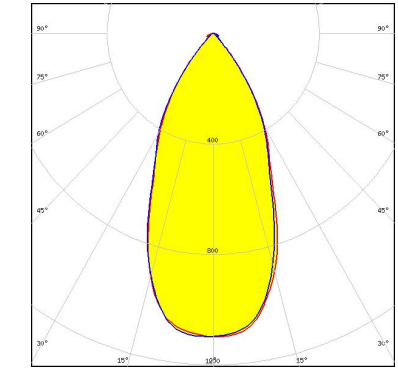

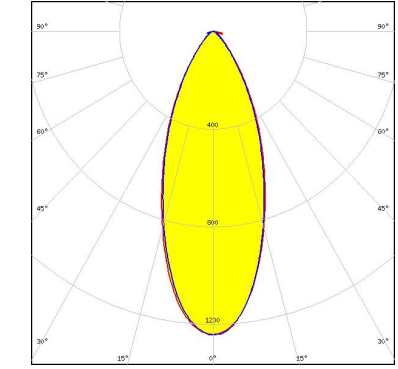
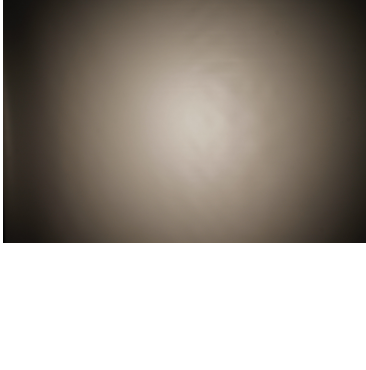
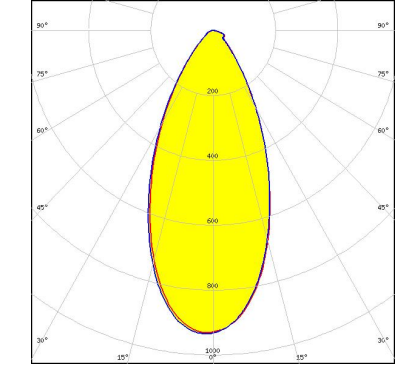
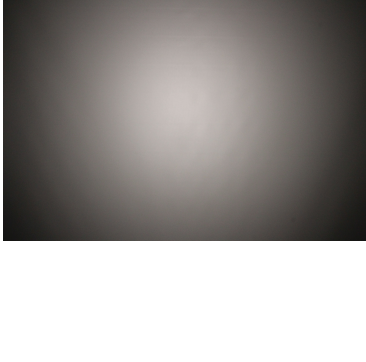
PHOTOMETRIC DATA (MEASURED):

<p>bridgelux.</p> <p>LED V9 HD FWHM 37.0° Efficiency 87 % Peak intensity 1.4 cd/lm LEDs/each optic 1 Light colour White Required components: F15859_HEKLA-SOCKET-I</p>		
<p>bridgelux.</p> <p>LED V9 HD FWHM 45.0° Efficiency 79 % Peak intensity 1.1 cd/lm LEDs/each optic 1 Light colour White Required components: F15859_HEKLA-SOCKET-I C13723_MIRELLA-RZL</p>		
<p>bridgelux.</p> <p>LED VERO10 FWHM 38.0° Efficiency 91 % Peak intensity 1.6 cd/lm LEDs/each optic 1 Light colour White Required components: F15616_HEKLA-SOCKET-F</p>		
<p>bridgelux.</p> <p>LED Vesta DTW 13mm (21W) FWHM 49.0° Efficiency 75 % Peak intensity 0.9 cd/lm LEDs/each optic 1 Light colour Tunable White Required components: C16142_HEKLA-SOCKET-K C13723_MIRELLA-RZL Bender Wirth: 491 Typ L8</p>		

PHOTOMETRIC DATA (MEASURED):

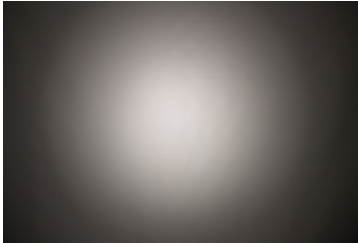
<p>bridgelux.</p> <p>LED Vesta DTW 13mm (21W) FWHM 47.0° Efficiency 84 % Peak intensity 1.1 cd/lm LEDs/each optic 1 Light colour Tunable White Required components: C16142_HEKLA-SOCKET-K Bender Wirth: 491 Typ L8</p>		
<p>bridgelux.</p> <p>LED Vesta DTW 9mm (4W/6W/12W) FWHM 41.0° Efficiency 80 % Peak intensity 1.2 cd/lm LEDs/each optic 1 Light colour White Required components: C16142_HEKLA-SOCKET-K C13723_MIRELLA-RZL Bender Wirth: 492 Typ L8</p>		
<p>bridgelux.</p> <p>LED Vesta TW 13mm (25W) CSP FWHM 47.0° Efficiency 75 % Peak intensity 0.9 cd/lm LEDs/each optic 1 Light colour White Required components: C16142_HEKLA-SOCKET-K C13723_MIRELLA-RZL Bender Wirth: 492 Typ L8</p>		
<p>bridgelux.</p> <p>LED Vesta TW 6mm DP FWHM 41.0° Efficiency 75 % Peak intensity 1.1 cd/lm LEDs/each optic 1 Light colour White Required components: C16142_HEKLA-SOCKET-K C13723_MIRELLA-RZL Bender Wirth: 504 Typ L8</p>		

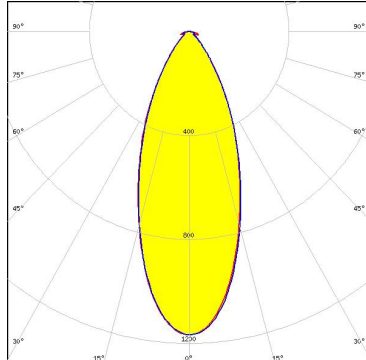
PHOTOMETRIC DATA (MEASURED):

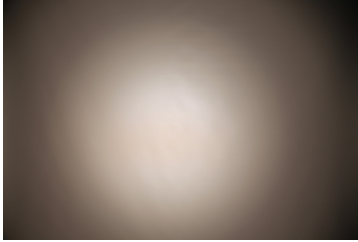
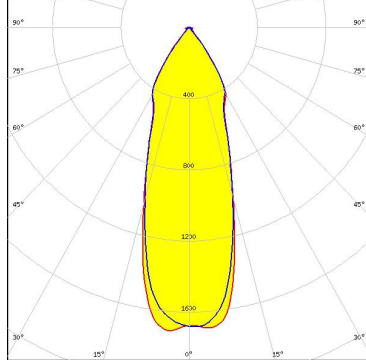
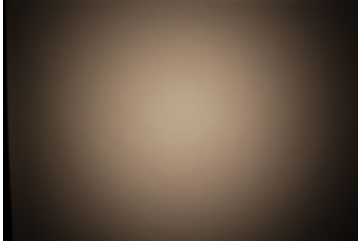
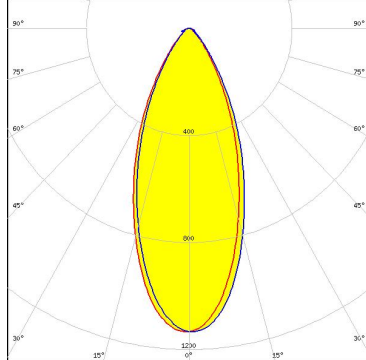
<p> LED Vesta TW 6mm DP FWHM 29.0° Efficiency 83 % Peak intensity 1.8 cd/lm LEDs/each optic 1 Light colour White Required components: C16142_HEKLA-SOCKET-K Bender Wirth: 504 Typ L8</p>		
<p> LED Vesta TW 9mm (12W) CSP FWHM 40.0° Efficiency 78 % Peak intensity 1.2 cd/lm LEDs/each optic 1 Light colour White Required components: C16142_HEKLA-SOCKET-K C13723_MIRELLA-RZL Bender Wirth: 489 Typ L8</p>		
<p> LED Vesta TW 9mm (12W) CSP FWHM 34.0° Efficiency 88 % Peak intensity 1.7 cd/lm LEDs/each optic 1 Light colour White Required components: C16142_HEKLA-SOCKET-K Bender Wirth: 490 Typ L8</p>		
<p>CITIZEN LED CLC020 Series (Dim-To-Warm) FWHM 42.0° Efficiency 77 % Peak intensity 1.1 cd/lm LEDs/each optic 1 Light colour White Required components: C16142_HEKLA-SOCKET-K C13723_MIRELLA-RZL Bender Wirth: 487 Typ L8</p>		

PHOTOMETRIC DATA (MEASURED):

CITIZEN

LED CLC020 Series (Dim-To-Warm)
 FWHM 36.0°
 Efficiency 85 %
 Peak intensity 1.6 cd/lm
 LEDs/each optic 1
 Light colour White
 Required components:
 C16142_HEKLA-SOCKET-K

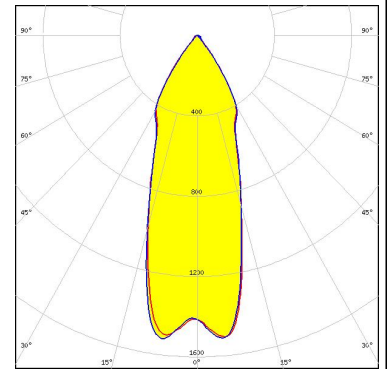
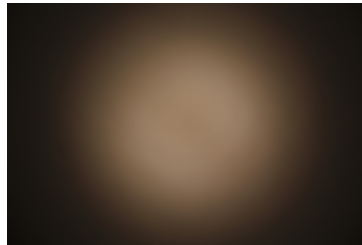

CITIZEN

LED CLU025/CLU027 (LES 6)
 FWHM 31.0°
 Efficiency 90 %
 Peak intensity 1.9 cd/lm
 LEDs/each optic 1
 Light colour White
 Required components:
 F15255_HEKLA-SOCKET-C

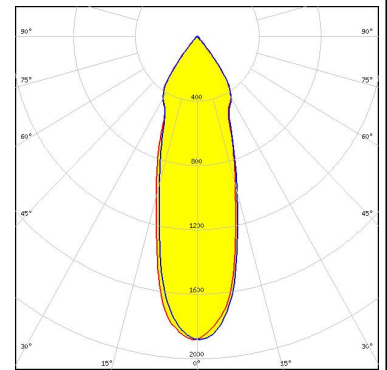
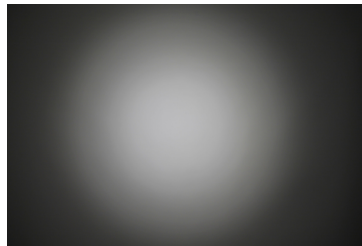

CITIZEN

LED CLU700/701/702
 FWHM 29.0°
 Efficiency 92 %
 Peak intensity 2 cd/lm
 LEDs/each optic 1
 Light colour White
 Required components:
 F15255_HEKLA-SOCKET-C

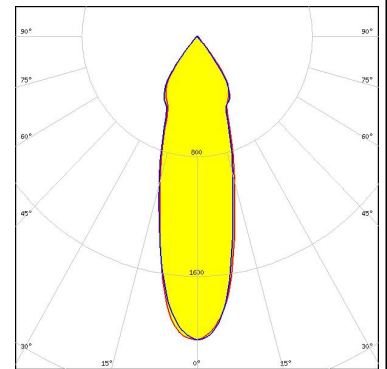
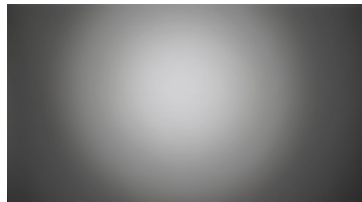

CITIZEN

LED CLU700/701/702
 FWHM 29.0°
 Efficiency 91 %
 Peak intensity 2 cd/lm
 LEDs/each optic 1
 Light colour White
 Required components:
 F15255_HEKLA-SOCKET-C
 C13723_MIRELLA-RZL

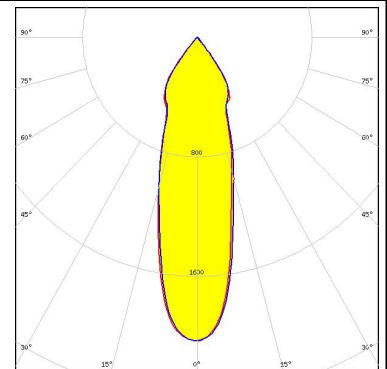
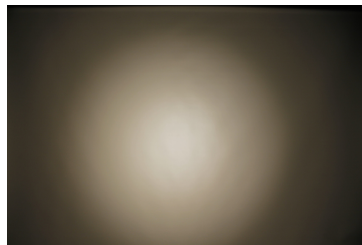

PHOTOMETRIC DATA (MEASURED):

CITIZEN

LED CLU710/711
 FWHM 37.0°
 Efficiency 87 %
 Peak intensity 1.5 cd/lm
 LEDs/each optic 1
 Light colour White
 Required components:
 F15859_HEKLA-SOCKET-I

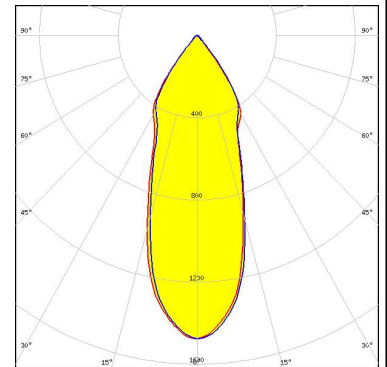
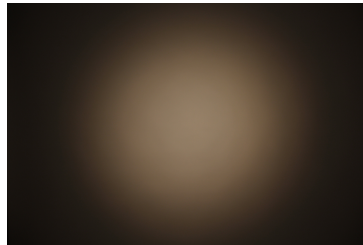

CITIZEN

LED CLU7A2 (LES 4.2mm)
 FWHM 24.0°
 Efficiency 89 %
 Peak intensity 2.1 cd/lm
 LEDs/each optic 1
 Light colour White
 Required components:
 F15255_HEKLA-SOCKET-C

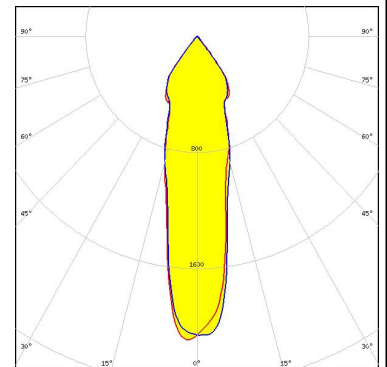
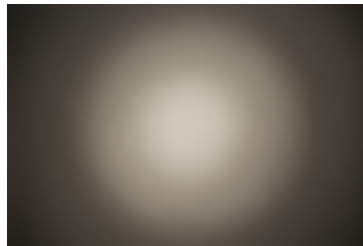

CITIZEN

LED LCN-C01B (Tunable White)
 FWHM 42.0°
 Efficiency 77 %
 Peak intensity 1.1 cd/lm
 LEDs/each optic 1
 Light colour White
 Required components:
 C16142_HEKLA-SOCKET-K
 C13723_MIRELLA-RZL
 Bender Wirth: 481 Typ L8

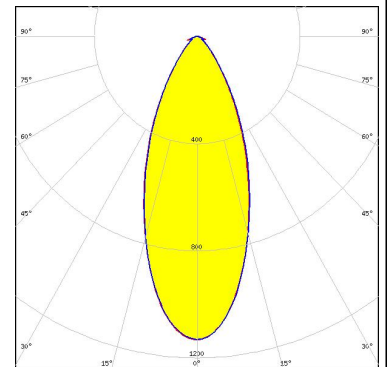
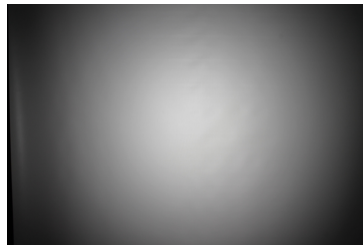

CITIZEN

LED LCN-C01B (Tunable White)
 FWHM 42.0°
 Efficiency 77 %
 Peak intensity 1.1 cd/lm
 LEDs/each optic 1
 Light colour White
 Required components:
 C16142_HEKLA-SOCKET-K
 C13723_MIRELLA-RZL
 Bender Wirth: 481 Typ L8

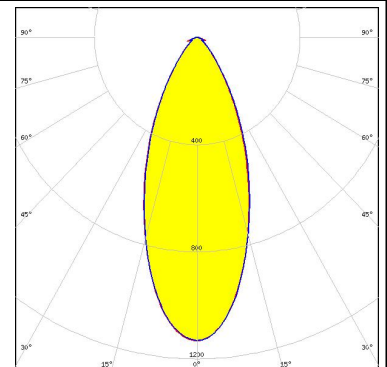
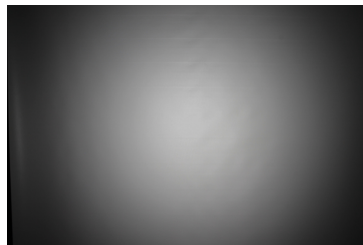

PHOTOMETRIC DATA (MEASURED):



LED CMA1516
 FWHM 40.0°
 Efficiency 88 %
 Peak intensity 1.3 cd/lm
 LEDs/each optic 1
 Light colour White
 Required components:
 F15256_HEKLA-SOCKET-D

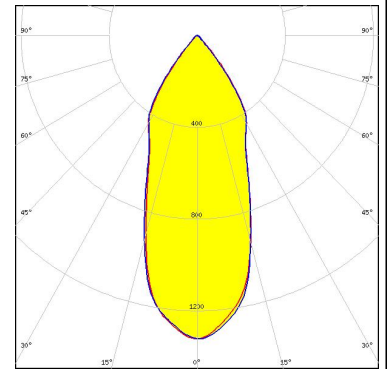
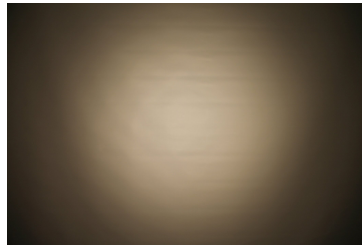

LED CMT14xx
 FWHM 41.0°
 Efficiency 88 %
 Peak intensity 1.3 cd/lm
 LEDs/each optic 1
 Light colour White
 Required components:
 F15255_HEKLA-SOCKET-C

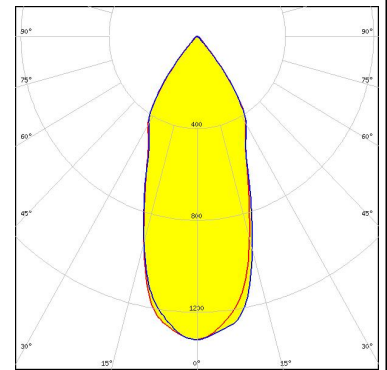
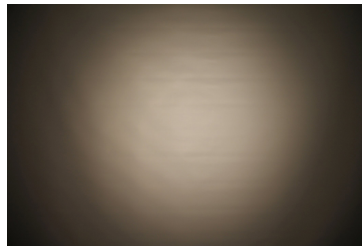

LED CXA/B 13xx
 FWHM 30.0°
 Efficiency 92 %
 Peak intensity 1.9 cd/lm
 LEDs/each optic 1
 Light colour White
 Required components:
 F15956_HEKLA-SOCKET-J
 C13333_MIRELLA-CL

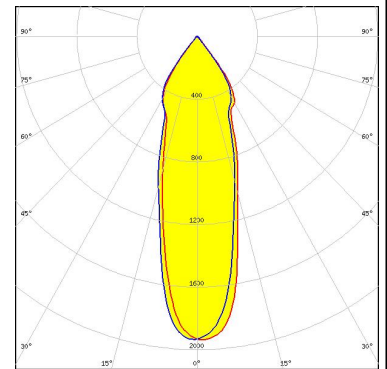

LED CXA/B 13xx
 FWHM 32.0°
 Efficiency 91 %
 Peak intensity 1.8 cd/lm
 LEDs/each optic 1
 Light colour White
 Required components:
 F15956_HEKLA-SOCKET-J

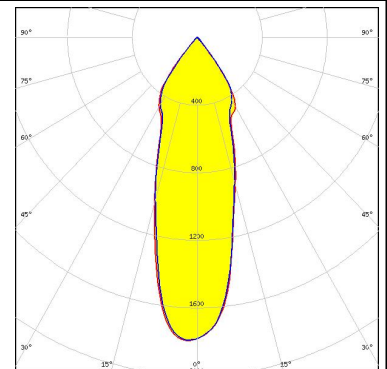
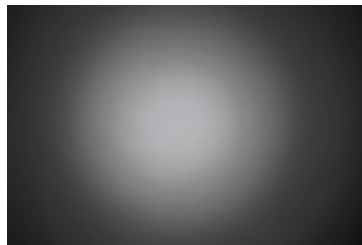

PHOTOMETRIC DATA (MEASURED):



LED CXA/B 15xx
 FWHM 37.0°
 Efficiency 91 %
 Peak intensity 1.6 cd/lm
 LEDs/each optic 1
 Light colour White
 Required components:
 F15256_HEKLA-SOCKET-D

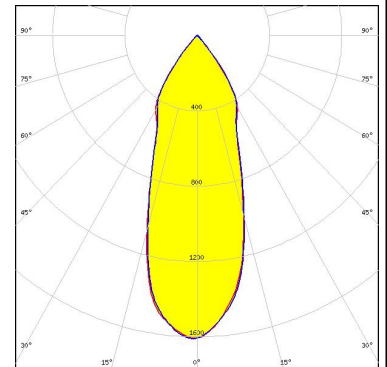
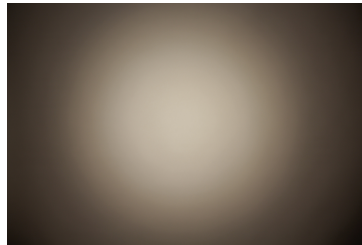

LED LUXEON CoB 1202/1203
 FWHM 38.0°
 Efficiency 90 %
 Peak intensity 1.5 cd/lm
 LEDs/each optic 1
 Light colour White
 Required components:
 F15858_HEKLA-SOCKET-H

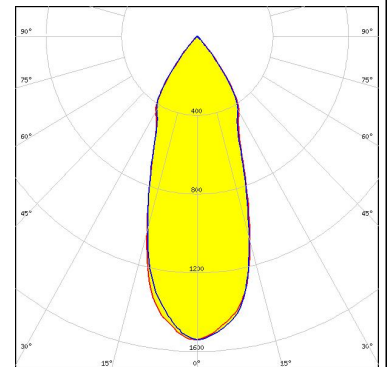
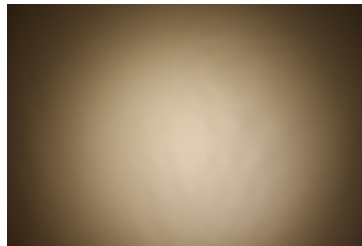



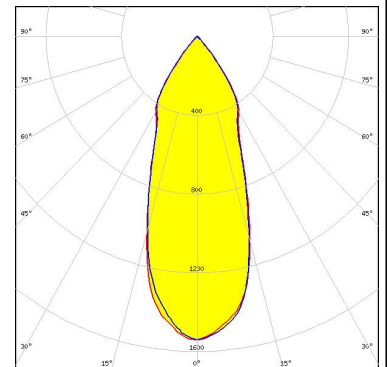
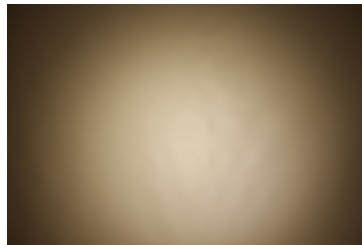

LED LUXEON CoB 1202/1203
 FWHM 38.0°
 Efficiency 90 %
 Peak intensity 1.5 cd/lm
 LEDs/each optic 1
 Light colour White
 Required components:
 F15858_HEKLA-SOCKET-H

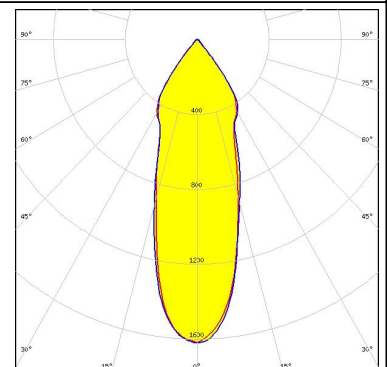
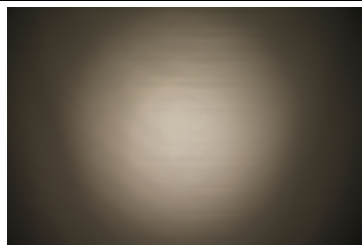

LED LUXEON CoB 1202HD
 FWHM 33.0°
 Efficiency 88 %
 Peak intensity 1.6 cd/lm
 LEDs/each optic 1
 Light colour White
 Required components:
 F15848_HEKLA-SOCKET-G

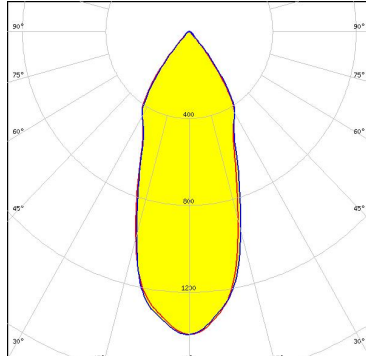

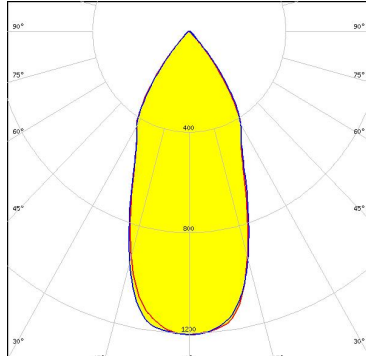
PHOTOMETRIC DATA (MEASURED):

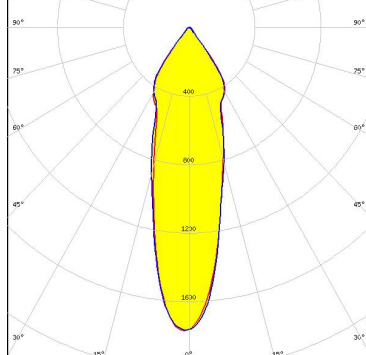
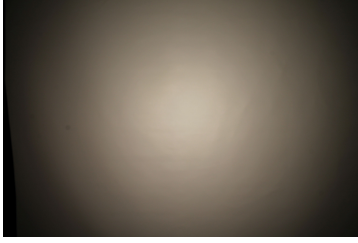
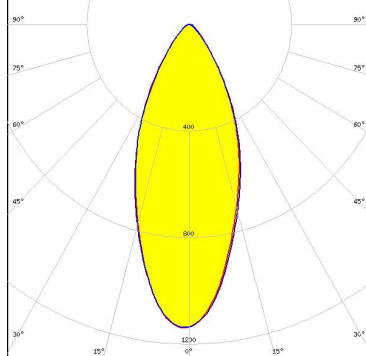
<p>LUMILEDS</p> <p>LED LUXEON CoB 1204HD FWHM 40.0° Efficiency 89 % Peak intensity 1.4 cd/lm LEDs/each optic 1 Light colour White Required components: F15858_HEKLA-SOCKET-H</p>		
<p>LUMILEDS</p> <p>LED LUXEON CoB 1205HD FWHM 44.0° Efficiency 87 % Peak intensity 1.2 cd/lm LEDs/each optic 1 Light colour White Required components: F15858_HEKLA-SOCKET-H</p>		
<p>LUMILEDS</p> <p>LED LUXEON CX Plus CoB - HD S01H4 FWHM 28.0° Efficiency 84 % Peak intensity 1.8 cd/lm LEDs/each optic 1 Light colour White Required components: Bender Wirth: 634c Hekla</p>		
<p>LUMILEDS</p> <p>LED LUXEON CX Plus CoB - HD S01H4 FWHM 42.0° Efficiency 76 % Peak intensity 1.1 cd/lm LEDs/each optic 1 Light colour White Required components: C13723_MIRELLA-RZL Bender Wirth: 634c Hekla</p>		

PHOTOMETRIC DATA (MEASURED):

LUMILEDS

LED LUXEON CX Plus CoB - HD S01H6 / HD S02H6
 FWHM 42.0°
 Efficiency 77 %
 Peak intensity 1.2 cd/lm
 LEDs/each optic 1
 Light colour White
 Required components:
 C13723_MIRELLA-RZL
 Bender Wirth: 634c Hekla

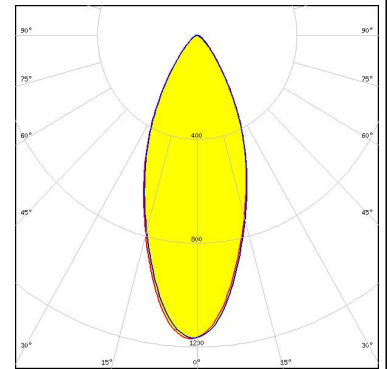

LUMILEDS

LED LUXEON CX Plus CoB - HD S01H6 / HD S02H6
 FWHM 29.0°
 Efficiency 84 %
 Peak intensity 1.8 cd/lm
 LEDs/each optic 1
 Light colour White
 Required components:
 Bender Wirth: 634c Hekla

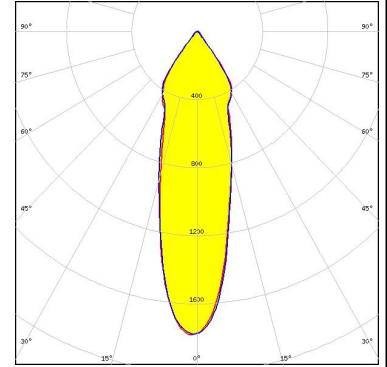

LUMILEDS

LED LUXEON CX Plus CoB - HD S04H9
 FWHM 46.0°
 Efficiency 78 %
 Peak intensity 1.1 cd/lm
 LEDs/each optic 1
 Light colour White
 Required components:
 C13723_MIRELLA-RZL
 Bender Wirth: 634c Hekla

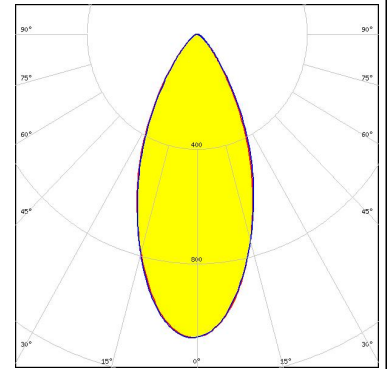
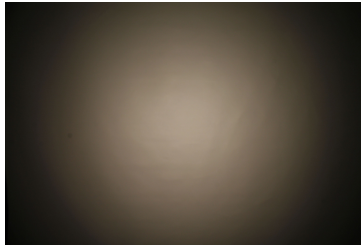



LUMILEDS

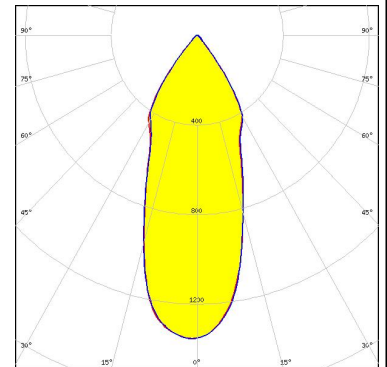
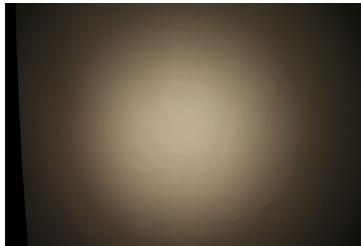

LED LUXEON CX Plus CoB - HD S04H9
 FWHM 38.0°
 Efficiency 85 %
 Peak intensity 1.4 cd/lm
 LEDs/each optic 1
 Light colour White
 Required components:
 Bender Wirth: 634c Hekla

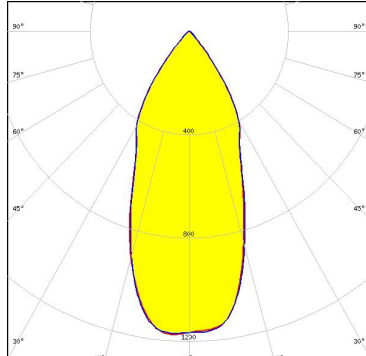

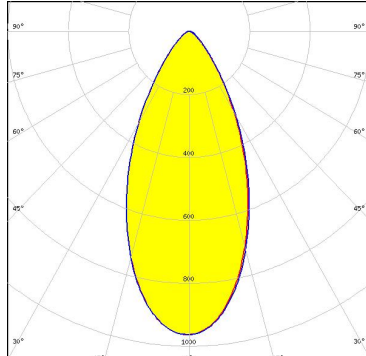
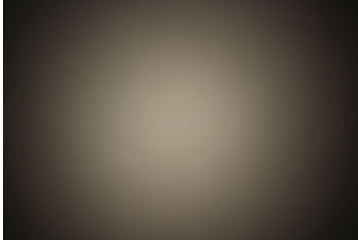
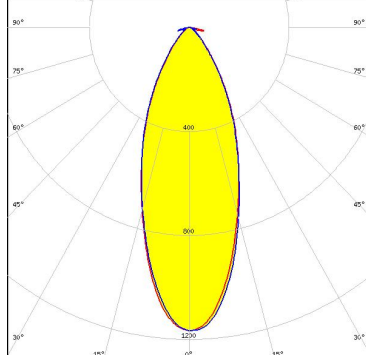
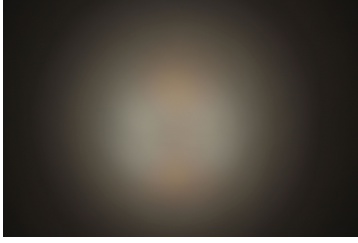
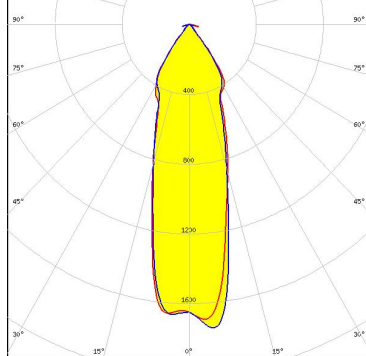

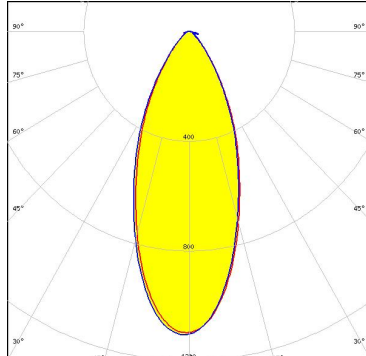

PHOTOMETRIC DATA (MEASURED):

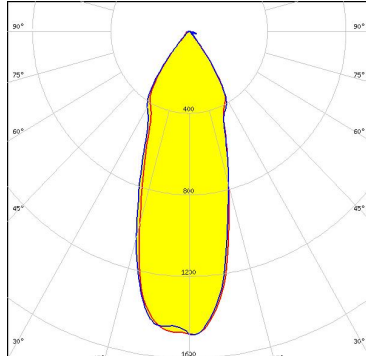
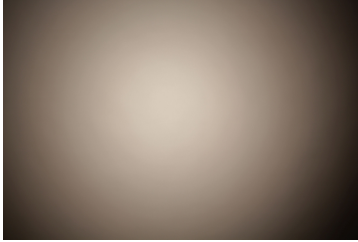
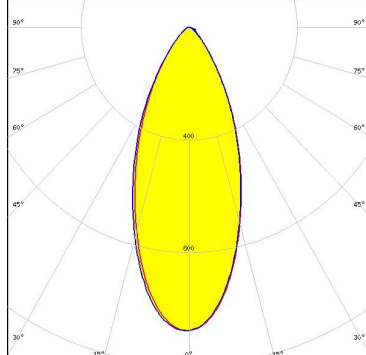
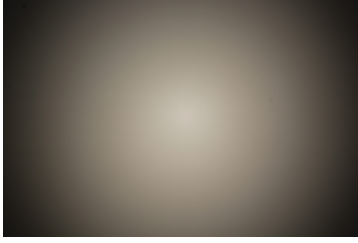
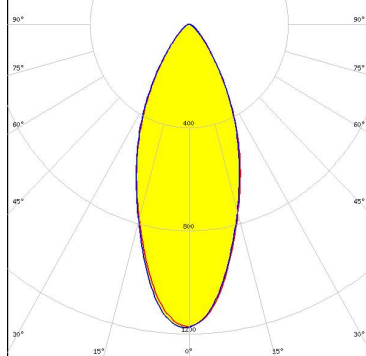
<p>LUMILEDS</p> <p>LED LUXEON CX Plus CoB L04 / L05 (Gen2)</p> <p>FWHM 44.0°</p> <p>Efficiency 83 %</p> <p>Peak intensity 1.2 cd/lm</p> <p>LEDs/each optic 1</p> <p>Light colour White</p> <p>Required components: Bender Wirth: 637a Hekla</p>		
<p>LUMILEDS</p> <p>LED LUXEON CX Plus CoB L04 / L05 (Gen2)</p> <p>FWHM 48.0°</p> <p>Efficiency 75 %</p> <p>Peak intensity 1 cd/lm</p> <p>LEDs/each optic 1</p> <p>Light colour White</p> <p>Required components: C13723_MIRELLA-RZL Bender Wirth: 637a Hekla</p>		
<p>LUMINUS</p> <p>LED CDM-6 (Dim-To-Warm)</p> <p>FWHM 39.0°</p> <p>Efficiency 76 %</p> <p>Peak intensity 1.2 cd/lm</p> <p>LEDs/each optic 1</p> <p>Light colour White</p> <p>Required components: C16142_HEKLA-SOCKET-K C13723_MIRELLA-RZL Bender Wirth: 490 Typ L8</p>		
<p>LUMINUS</p> <p>LED CDM-6 (Dim-To-Warm)</p> <p>FWHM 30.0°</p> <p>Efficiency 84 %</p> <p>Peak intensity 1.8 cd/lm</p> <p>LEDs/each optic 1</p> <p>Light colour White</p> <p>Required components: C16142_HEKLA-SOCKET-K Bender Wirth: 490 Typ L8</p>		



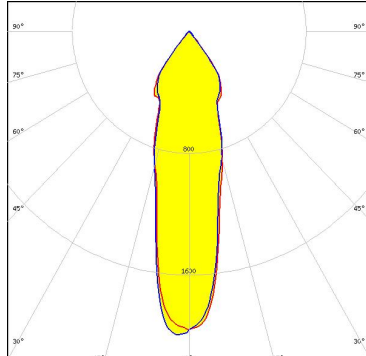

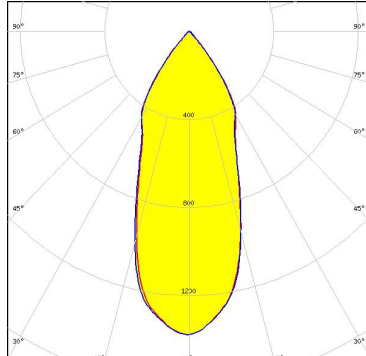
PHOTOMETRIC DATA (MEASURED):

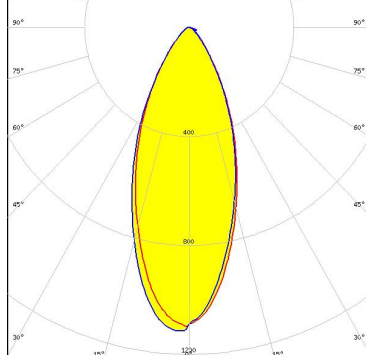
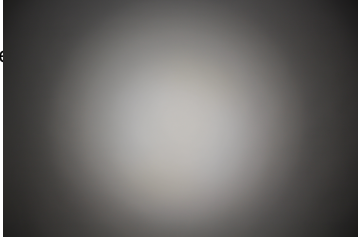
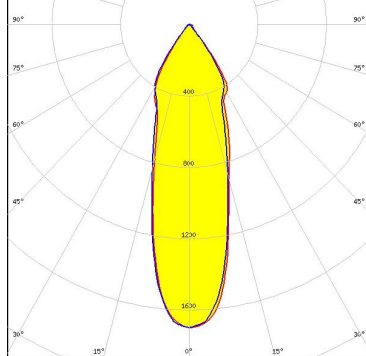
<p>LUMINUS</p> <p>LED CDM-9 (Dim-To-Warm) FWHM 42.0° Efficiency 75 % Peak intensity 1.1 cd/lm LEDs/each optic 1 Light colour White</p> <p>Required components: C16142_HEKLA-SOCKET-K C13723_MIRELLA-RZL Bender Wirth: 490 Typ L8</p>		
<p>LUMINUS</p> <p>LED CDM-9 (Dim-To-Warm) FWHM 35.0° Efficiency 83 % Peak intensity 1.5 cd/lm LEDs/each optic 1 Light colour White</p> <p>Required components: C16142_HEKLA-SOCKET-K Bender Wirth: 490 Typ L8</p>		
<p>LUMINUS</p> <p>LED CTM-9 (Tunable White) FWHM 43.0° Efficiency 75 % Peak intensity 1.1 cd/lm LEDs/each optic 1 Light colour White</p> <p>Required components: C16142_HEKLA-SOCKET-K C13723_MIRELLA-RZL Bender Wirth: 495 Typ L8</p>		
<p>LUMINUS</p> <p>LED CXM-4 FWHM 41.0° Efficiency 79 % Peak intensity 1.2 cd/lm LEDs/each optic 1 Light colour White</p> <p>Required components: F15255_HEKLA-SOCKET-C C13723_MIRELLA-RZL</p>		

PHOTOMETRIC DATA (MEASURED):

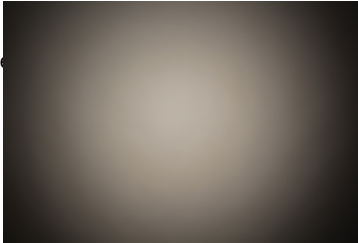
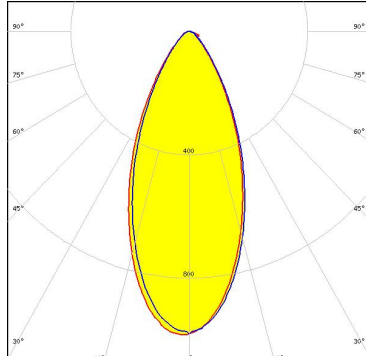
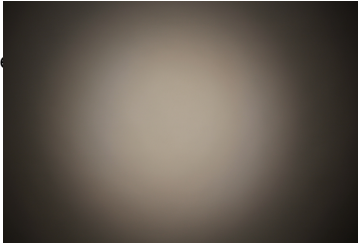
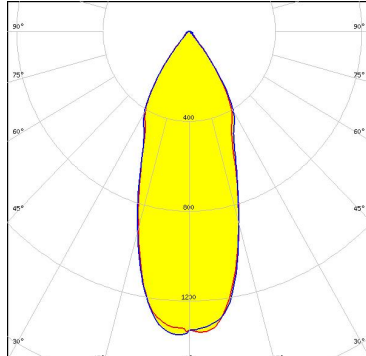
<p>LUMINUS</p> <p>LED CXM-4 FWHM 26.0° Efficiency 88 % Peak intensity 2 cd/lm LEDs/each optic 1 Light colour White Required components: F15255_HEKLA-SOCKET-C</p>		
<p>LUMINUS</p> <p>LED CxM-9 (13.5x13.5) FWHM 40.0° Efficiency 89 % Peak intensity 1.4 cd/lm LEDs/each optic 1 Light colour White Required components: F15255_HEKLA-SOCKET-C</p>		
<p>NICHIA</p> <p>LED NJCWL024Z-V1MT: COB L-Type Tunable White FWHM 41.0° Efficiency 74 % Peak intensity 1.1 cd/lm LEDs/each optic 1 Light colour White Required components: C16142_HEKLA-SOCKET-K C13723_MIRELLA-RZL Bender Wirth: 497 Typ L8</p>		
<p>NICHIA</p> <p>LED NJCWL024Z-V1MT: COB L-Type Tunable White FWHM 30.0° Efficiency 83 % Peak intensity 1.7 cd/lm LEDs/each optic 1 Light colour White Required components: C16142_HEKLA-SOCKET-K Bender Wirth: 497 Typ L8</p>		

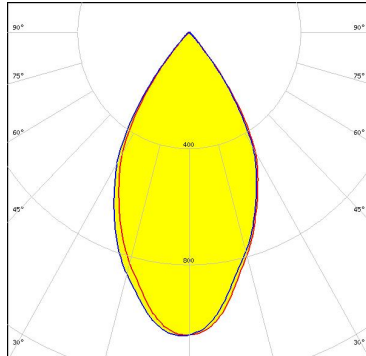
PHOTOMETRIC DATA (MEASURED):

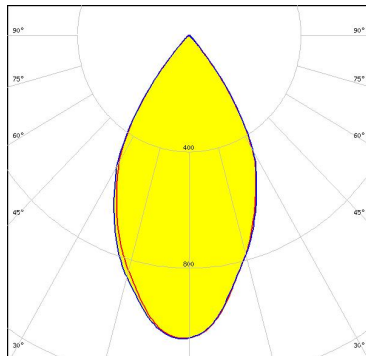
<p>NICHIA</p> <p>LED NVCWJ024Z-V1MT: COB J-Type Tunable White</p> <p>FWHM 45.0°</p> <p>Efficiency 74 %</p> <p>Peak intensity 1 cd/lm</p> <p>LEDs/each optic 1</p> <p>Light colour White</p> <p>Required components: C16142_HEKLA-SOCKET-K C13723_MIRELLA-RZL Bender Wirth: 498 Typ L8</p>		
<p>NICHIA</p> <p>LED NVCWJ024Z-V1MT: COB J-Type Tunable White</p> <p>FWHM 39.0°</p> <p>Efficiency 84 %</p> <p>Peak intensity 1.3 cd/lm</p> <p>LEDs/each optic 1</p> <p>Light colour White</p> <p>Required components: C16142_HEKLA-SOCKET-K Bender Wirth: 498 Typ L8</p>		
<p>OSRAM <small>Opto Semiconductors</small></p> <p>LED Soleriq S9</p> <p>FWHM 57.0°</p> <p>Efficiency 84 %</p> <p>Peak intensity 1 cd/lm</p> <p>LEDs/each optic 1</p> <p>Light colour White</p> <p>Required components: F15255_HEKLA-SOCKET-C C12479_MIRELLA-DL</p>		
<p>OSRAM <small>Opto Semiconductors</small></p> <p>LED Soleriq S9</p> <p>FWHM 57.0°</p> <p>Efficiency 84 %</p> <p>Peak intensity 1 cd/lm</p> <p>LEDs/each optic 1</p> <p>Light colour White</p> <p>Required components: F15255_HEKLA-SOCKET-C</p>		

PHOTOMETRIC DATA (MEASURED):

PHILIPS

LED Fortimo SLM L09 CoB
 FWHM 46.0°
 Efficiency 79 %
 Peak intensity 1.1 cd/lm
 LEDs/each optic 1
 Light colour White
 Required components:
 F15858_HEKLA-SOCKET-H
 C13723_MIRELLA-RZL

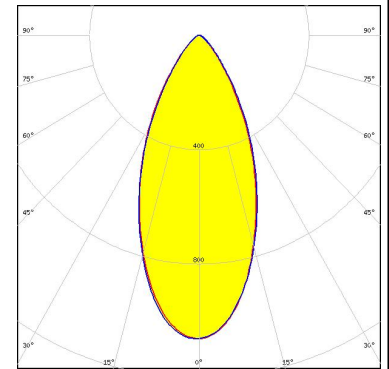
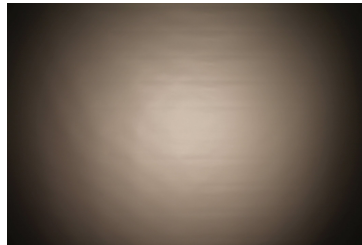

PHILIPS

LED Fortimo SLM L09 CoB
 FWHM 39.0°
 Efficiency 88 %
 Peak intensity 1.4 cd/lm
 LEDs/each optic 1
 Light colour White
 Required components:
 F15858_HEKLA-SOCKET-H

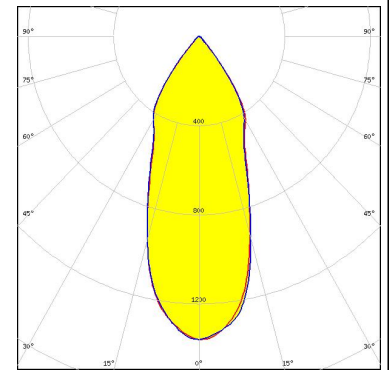
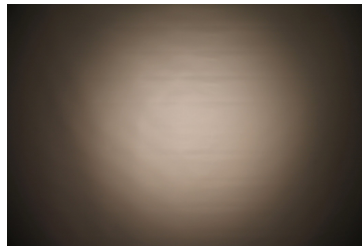

PHILIPS

LED Fortimo SLM L13 CoB
 FWHM 47.0°
 Efficiency 83 %
 Peak intensity 1.1 cd/lm
 LEDs/each optic 1
 Light colour White
 Required components:
 C16142_HEKLA-SOCKET-K
 Bender Wirth: 432 Typ L8

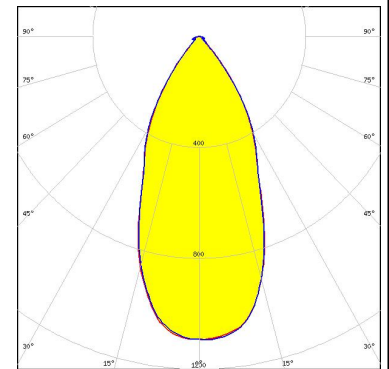
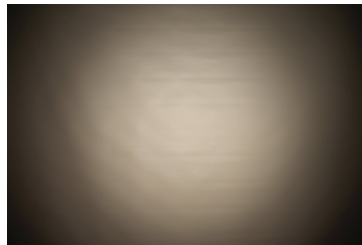

PHILIPS

LED Fortimo SLM L13 CoB
 FWHM 47.0°
 Efficiency 83 %
 Peak intensity 1.1 cd/lm
 LEDs/each optic 1
 Light colour White
 Required components:
 C16142_HEKLA-SOCKET-K
 Bender Wirth: 432 Typ L8

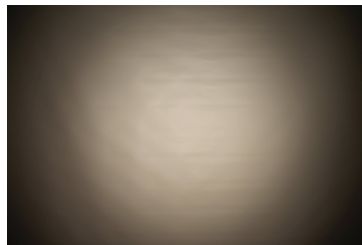

PHOTOMETRIC DATA (MEASURED):

PHILIPS

LED Fortimo SLM L13 CoB
 FWHM 49.0°
 Efficiency 77 %
 Peak intensity 0.9 cd/lm
 LEDs/each optic 1
 Light colour White
 Required components:
 C16142_HEKLA-SOCKET-K
 C13723_MIRELLA-RZL
 Bender Wirth: 432 Typ L8

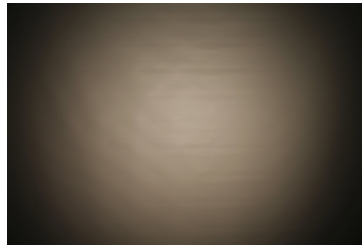

PHILIPS

LED Fortimo SLM L13 CoB
 FWHM 49.0°
 Efficiency 77 %
 Peak intensity 0.9 cd/lm
 LEDs/each optic 1
 Light colour White
 Required components:
 C16142_HEKLA-SOCKET-K
 C13723_MIRELLA-RZL
 Bender Wirth: 432 Typ L8

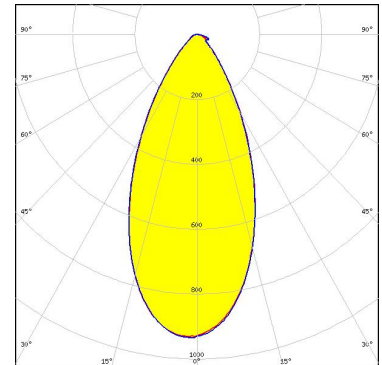
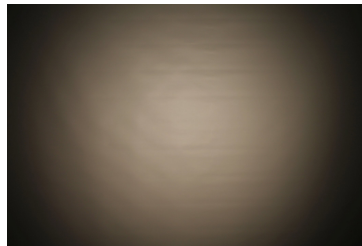

SAMSUNG

LED LC010C G2
 FWHM 29.0°
 Efficiency 88 %
 Peak intensity 1.8 cd/lm
 LEDs/each optic 1
 Light colour White
 Required components:
 F15255_HEKLA-SOCKET-C

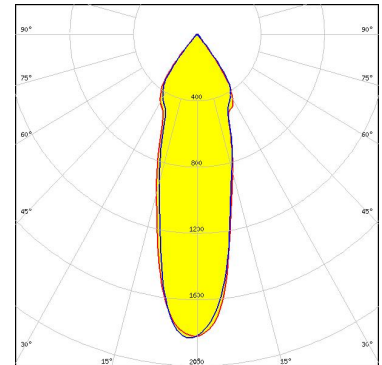
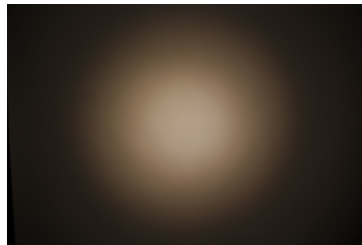

SAMSUNG

LED LC010T (Tunable White)
 FWHM 37.0°
 Efficiency 79 %
 Peak intensity 1.3 cd/lm
 LEDs/each optic 1
 Light colour Tunable White
 Required components:
 C16142_HEKLA-SOCKET-K
 C14658_BARBARA-RZ-LENS
 Bender Wirth: 501 Typ L8

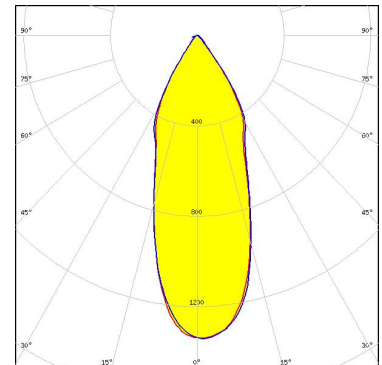
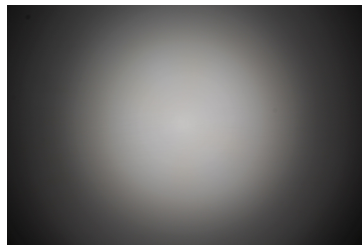

PHOTOMETRIC DATA (MEASURED):

SAMSUNG

LED LC010T (Tunable White)
 FWHM 36.0°
 Efficiency 84 %
 Peak intensity 1.4 cd/lm
 LEDs/each optic 1
 Light colour Tunable White
 Required components:
 C16142_HEKLA-SOCKET-K
 Bender Wirth: 501 Typ L8

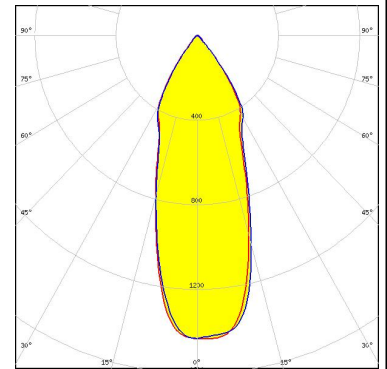
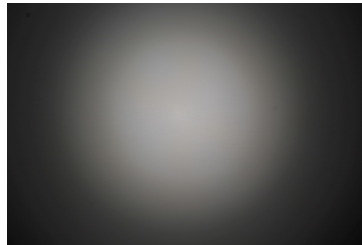

SAMSUNG

LED LC016D / LC019D / LC026D / LC033D
 FWHM 53.0°
 Efficiency 79 %
 Peak intensity 0.9 cd/lm
 LEDs/each optic 1
 Light colour White
 Required components:
 F15859_HEKLA-SOCKET-I
 C12479_MIRELLA-DL

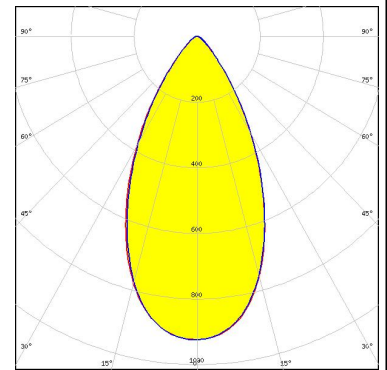
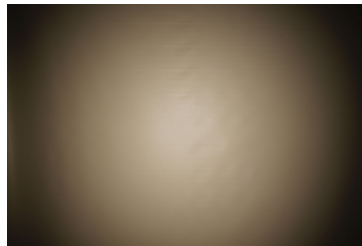

SAMSUNG

LED LC016D / LC019D / LC026D / LC033D
 FWHM 52.0°
 Efficiency 87 %
 Peak intensity 1.1 cd/lm
 LEDs/each optic 1
 Light colour White
 Required components:
 F15859_HEKLA-SOCKET-I

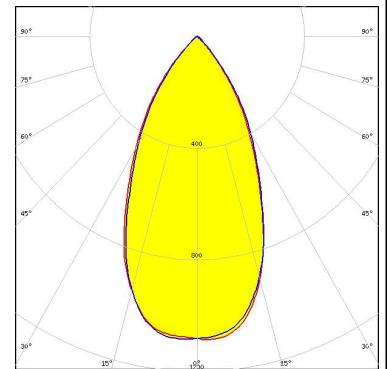
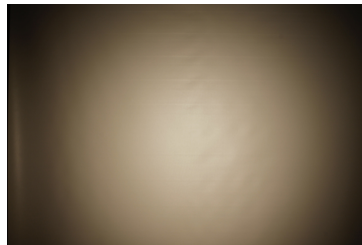

SAMSUNG

LED LC016D / LC019D / LC026D / LC033D
 FWHM 51.0°
 Efficiency 77 %
 Peak intensity 0.9 cd/lm
 LEDs/each optic 1
 Light colour White
 Required components:
 F15859_HEKLA-SOCKET-I
 C13723_MIRELLA-RZL

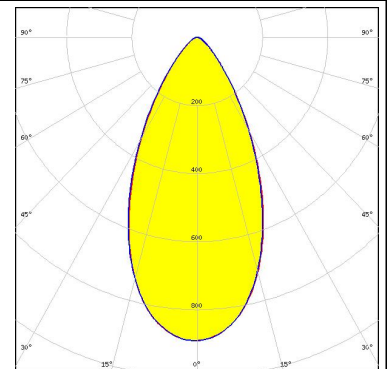
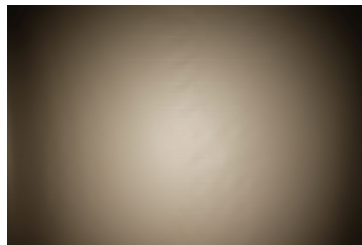

PHOTOMETRIC DATA (MEASURED):

SAMSUNG

LED LC016D / LC019D / LC026D / LC033D
 FWHM 53.0°
 Efficiency 82 %
 Peak intensity 1 cd/lm
 LEDs/each optic 1
 Light colour White
 Required components:
 F15859_HEKLA-SOCKET-I
 C13333_MIRELLA-CL

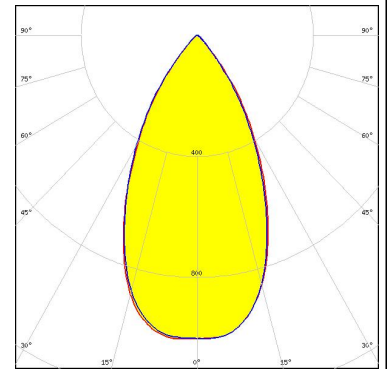
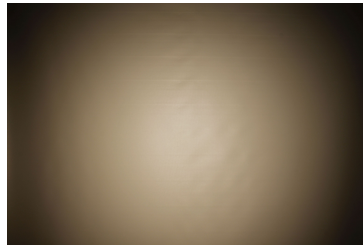

SAMSUNG

LED LC020C
 FWHM 36.0°
 Efficiency 90 %
 Peak intensity 1.6 cd/lm
 LEDs/each optic 1
 Light colour White
 Required components:
 F15848_HEKLA-SOCKET-G

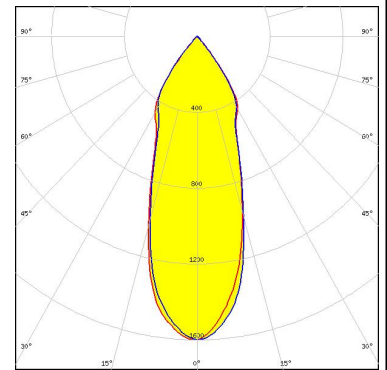
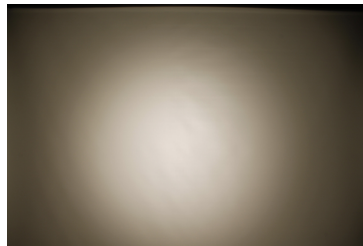

SAMSUNG

LED LC020C G2
 FWHM 38.0°
 Efficiency 87 %
 Peak intensity 1.4 cd/lm
 LEDs/each optic 1
 Light colour White
 Required components:
 F15859_HEKLA-SOCKET-I

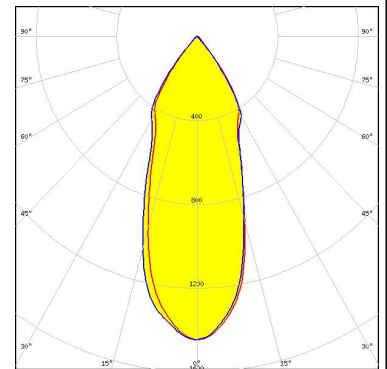
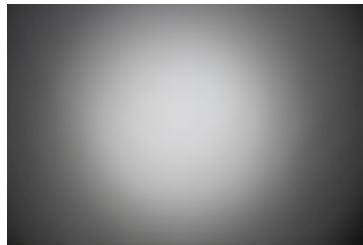

TRIDONIC

LED SLE G7 LES09
 FWHM 46.0°
 Efficiency 82 %
 Peak intensity 1.1 cd/lm
 LEDs/each optic 1
 Light colour White
 Required components:
 F15255_HEKLA-SOCKET-C
 C13723_MIRELLA-RZL

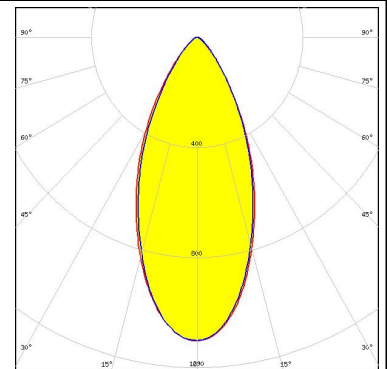
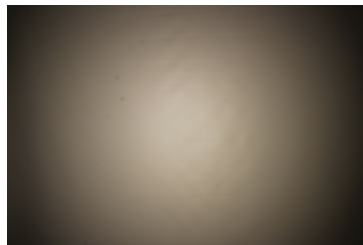

PHOTOMETRIC DATA (MEASURED):

TRIDONIC

LED SLE G7 LES09
 FWHM 38.0°
 Efficiency 90 %
 Peak intensity 1.5 cd/lm
 LEDs/each optic 1
 Light colour White
 Required components:
 F15255_HEKLA-SOCKET-C

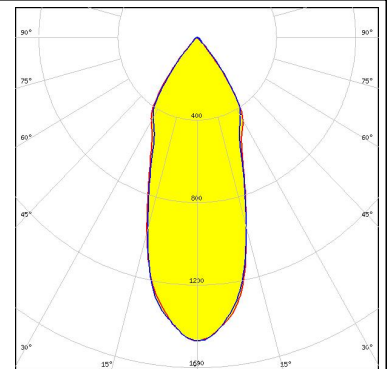
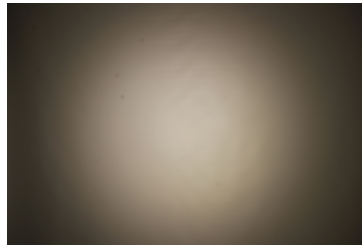

TRIDONIC

LED SLE G7 LES13
 FWHM 48.0°
 Efficiency 86 %
 Peak intensity 1.1 cd/lm
 LEDs/each optic 1
 Light colour White
 Required components:
 F15859_HEKLA-SOCKET-I

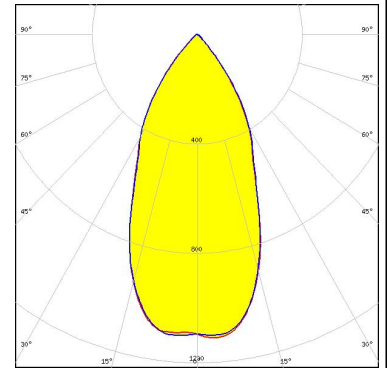
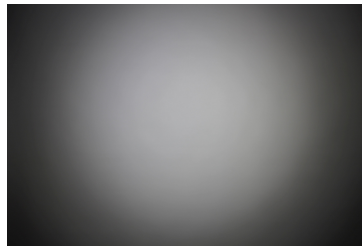

TRIDONIC

LED SLE G7 LES13
 FWHM 50.0°
 Efficiency 77 %
 Peak intensity 0.9 cd/lm
 LEDs/each optic 1
 Light colour White
 Required components:
 F15859_HEKLA-SOCKET-I
 C13723_MIRELLA-RZL

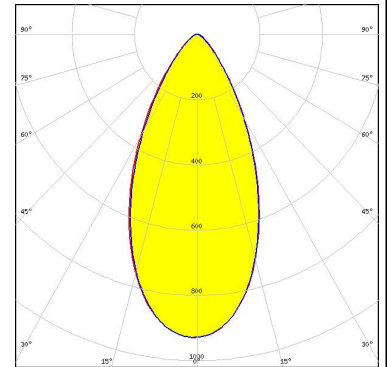
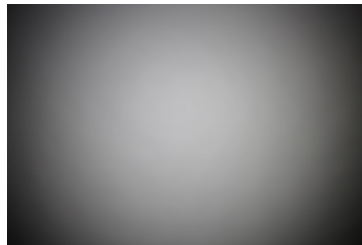

XICATO

LED XOB 14.5 mm
 FWHM 51.0°
 Efficiency 78 %
 Peak intensity 0.9 cd/lm
 LEDs/each optic 1
 Light colour White
 Required components:
 F15859_HEKLA-SOCKET-I
 C13723_MIRELLA-RZL

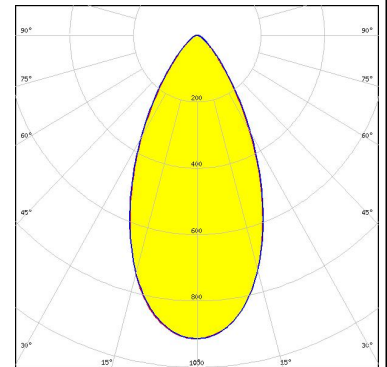
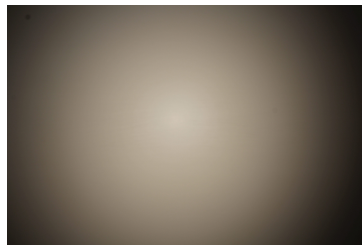

PHOTOMETRIC DATA (MEASURED):

XICATO

LED XOB 14.5 mm
 FWHM 52.0°
 Efficiency 86 %
 Peak intensity 1.1 cd/lm
 LEDs/each optic 1
 Light colour White
 Required components:
 F15859_HEKLA-SOCKET-I

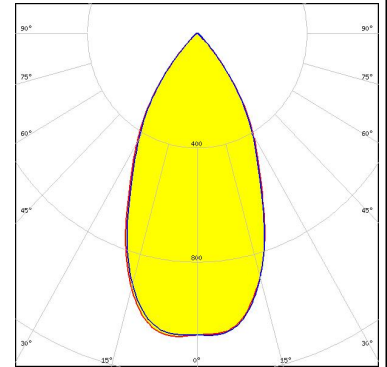

XICATO

LED XOB 6 mm
 FWHM 44.0°
 Efficiency 78 %
 Peak intensity 1.1 cd/lm
 LEDs/each optic 1
 Light colour White
 Required components:
 F15255_HEKLA-SOCKET-C
 C13723_MIRELLA-RZL

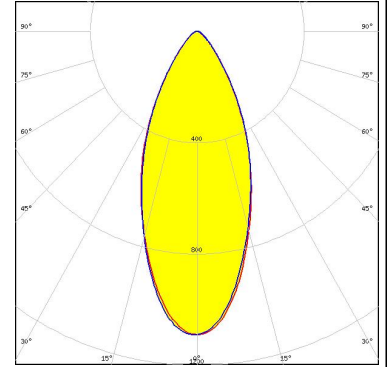

XICATO

LED XOB 6 mm
 FWHM 32.0°
 Efficiency 88 %
 Peak intensity 1.7 cd/lm
 LEDs/each optic 1
 Light colour White
 Required components:
 F15255_HEKLA-SOCKET-C

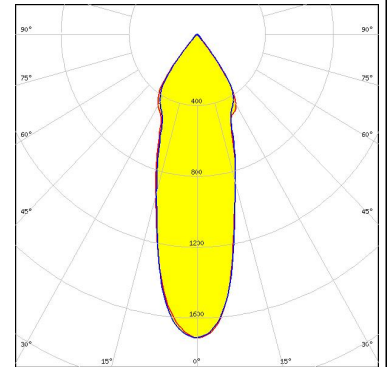
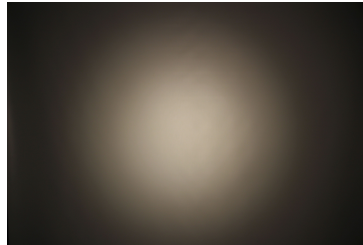

XICATO

LED XOB 9.8 mm
 FWHM 47.0°
 Efficiency 80 %
 Peak intensity 1.1 cd/lm
 LEDs/each optic 1
 Light colour White
 Required components:
 F15255_HEKLA-SOCKET-C
 C13723_MIRELLA-RZL

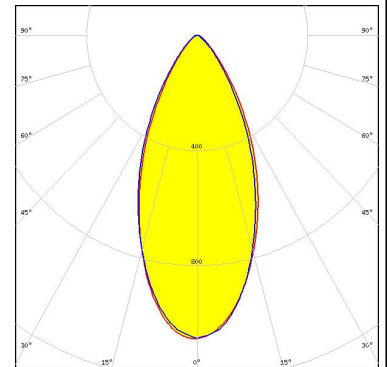
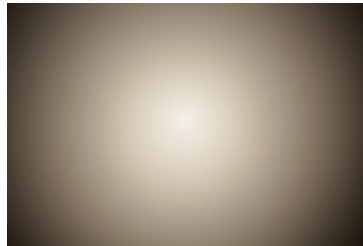

PHOTOMETRIC DATA (MEASURED):

XICATO

LED XOB 9.8 mm
FWHM 39.0°
Efficiency 88 %
Peak intensity 1.4 cd/lm
LEDs/each optic 1
Light colour White
Required components:
F15255_HEKLA-SOCKET-C
C13723_MIRELLA-RZL

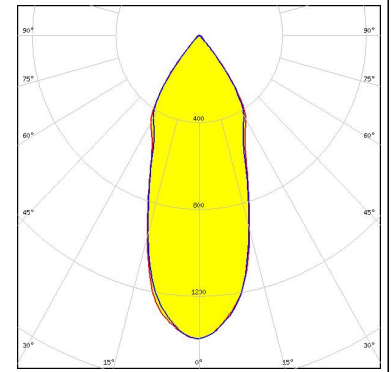

PHOTOMETRIC DATA (SIMULATED):



LED VERO13
FWHM 39.0°
Efficiency 87 %
Peak intensity 1.5 cd/lm
LEDs/each optic 1
Light colour White
Required components:
 C16142_HEKLA-SOCKET-K

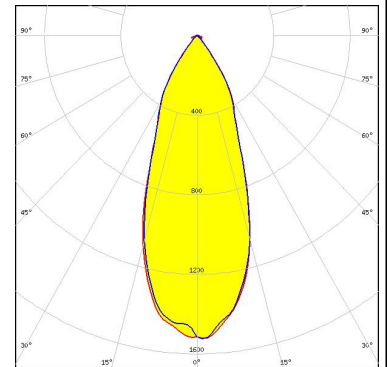

CITIZEN

LED CLL02x/CLU02x (LES10)
FWHM 37.2°
Efficiency 88 %
Peak intensity 1.7 cd/lm
LEDs/each optic 1
Light colour White
Required components:
 F15255_HEKLA-SOCKET-C

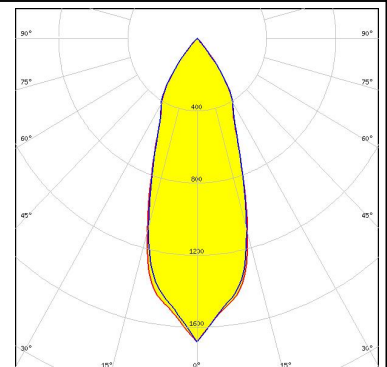

LED COB L-Type (LES 11)
FWHM 42.0°
Efficiency 90 %
Peak intensity 1.5 cd/lm
LEDs/each optic 1
Light colour White
Required components:
 F15858_HEKLA-SOCKET-H

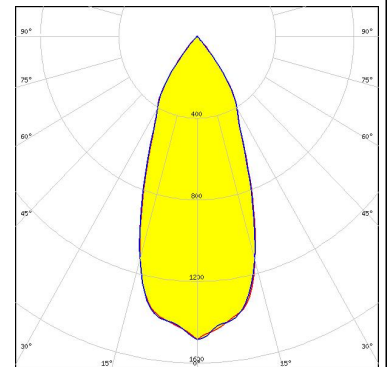

LED COB T-Type
FWHM 30.0°
Efficiency 88 %
Peak intensity 2 cd/lm
LEDs/each optic 1
Light colour White
Required components:
 F15848_HEKLA-SOCKET-G

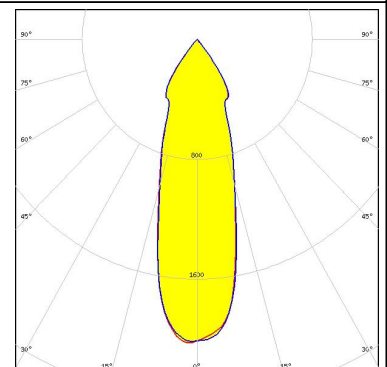

GENERAL INFORMATION:

NOTE: The typical beam angle will be changed by different color, chip size and chip position tolerance. The typical total beam angle is the full angle measured where the luminous intensity is half of the peak value.

Due to use of high power COB's with this product, special attention to proper thermal design is highly recommended. LEDiL has no liability for direct, indirect or consecutive damages arising from the LEDiL products being used outside of the recommended temperature range.

MATERIALS:

As part of our continuous research and improvement processes, and to ensure the best possible quality and availability of our products, LEDiL reserves the right to change material grades without notice.

PRODUCT DATA USER AGREEMENT AND DISCLAIMER:

The measured data in the provided downloadable LEDiL Product Datasheets and Mechanical 2D-Drawings is rounded and provided as reference for planning. LEDiL Oy's optical specifications have been verified by conducting performance testing of the products in accordance with the company's quality system. The reported data are averaged results of multiple measurements with typical variation. LEDiL Oy reserves the right to without prior notification make changes and improvements to its products.

LEDiL Oy assumes neither warranty, nor guarantee nor any other liability of any kind for the contents and correctness of the provided data. The provided data has been generated with highest diligence but the provided data may in reality not represent the complete possible variation range of all intrinsic parameters. Therefore, in certain cases a deviation from the provided data could occur.

LEDiL Oy reserves the right to undertake technical changes of its products without further notification which could lead to changes in the provided data. LEDiL Oy assumes no liability of any kind for the possible deviation from any provided data or any other damage resulting from the usage of the provided data.

The user agrees to this disclaimer and user agreement with the download or usage of the provided files.

LEDiL Oy

Joensuunkatu 13
FI-24240 SALO
Finland

LEDiL Inc.

228 West Page Street
Suite D
Sycamore IL 60178
USA

Ledil Optics Technology (Shenzhen) Co., Ltd.

405 , Block B
Casic Motor Building
Shenzhen 518057
P.R.CHINA

Local sales and technical support

[www.ledil.com/
where_to_buy](http://www.ledil.com/where_to_buy)

Shipping locations

Salo, Finland
Hong Kong, China

Distribution Partners

[www.ledil.com/
where_to_buy](http://www.ledil.com/where_to_buy)