

DS RELAYS

High sensitivity 200 mW Rated operating power, 1 Form C, 2A relays

Protective construction : Sealed type

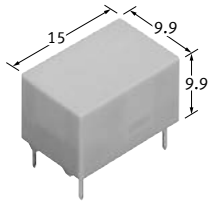

(Unit : mm)

FEATURES

- **High sensitivity: 200 mW rated operating power (High sensitivity type, single side stable)**

TYPICAL APPLICATIONS

- Telecommunications
- Measurement equipment
- OA equipment
- Information related equipment
- Industrial machines

ORDERING INFORMATION (PART NO.)

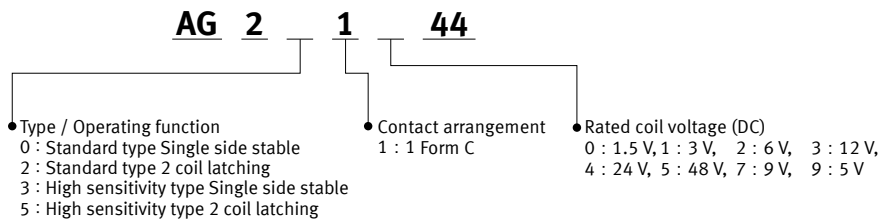

ORDERING INFORMATION (TYPE NO.)

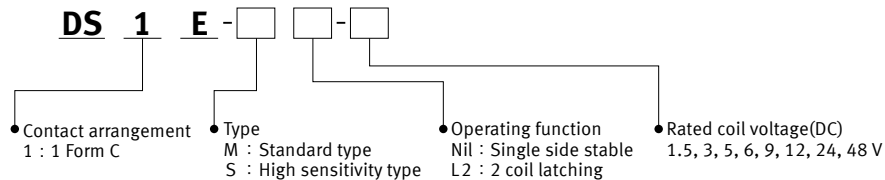

Signal Relays (2A or less) DS RELAYS

TYPES

■ PC board terminal

● Standard type (M): Carton

Contact arrangement	Rated coil voltage	Single side stable		2 coil latching		Standard packing	
		Type No.	Part No.	Type No.	Part No.	Inner carton	Outer carton
1 Form C	1.5 V DC	DS1E-M-DC1.5V	AG201044	DS1E-ML2-DC1.5V	AG221044	50 pcs.	500 pcs.
	3 V DC	DS1E-M-DC3V	AG201144	DS1E-ML2-DC3V	AG221144		
	5 V DC	DS1E-M-DC5V	AG201944	DS1E-ML2-DC5V	AG221944		
	6 V DC	DS1E-M-DC6V	AG201244	DS1E-ML2-DC6V	AG221244		
	9 V DC	DS1E-M-DC9V	AG201744	DS1E-ML2-DC9V	AG221744		
	12 V DC	DS1E-M-DC12V	AG201344	DS1E-ML2-DC12V	AG221344		
	24 V DC	DS1E-M-DC24V	AG201444	DS1E-ML2-DC24V	AG221444		
	48 V DC	DS1E-M-DC48V	AG201544	DS1E-ML2-DC48V	AG221544		

● High sensitivity type (S): Carton

Contact arrangement	Rated coil voltage	Single side stable		2 coil latching		Standard packing	
		Type No.	Part No.	Type No.	Part No.	Inner carton	Outer carton
1 Form C	1.5 V DC	DS1E-S-DC1.5V	AG231044	DS1E-SL2-DC1.5V	AG251044	50 pcs.	500 pcs.
	3 V DC	DS1E-S-DC3V	AG231144	DS1E-SL2-DC3V	AG251144		
	5 V DC	DS1E-S-DC5V	AG231944	DS1E-SL2-DC5V	AG251944		
	6 V DC	DS1E-S-DC6V	AG231244	DS1E-SL2-DC6V	AG251244		
	9 V DC	DS1E-S-DC9V	AG231744	DS1E-SL2-DC9V	AG251744		
	12 V DC	DS1E-S-DC12V	AG231344	DS1E-SL2-DC12V	AG251344		
	24 V DC	DS1E-S-DC24V	AG231444	DS1E-SL2-DC24V	AG251444		
	48 V DC	DS1E-S-DC48V	AG231544	DS1E-SL2-DC48V	AG251544		

RATING

■ Coil data

- Operating characteristics such as "Operate voltage" and "Release voltage" are influenced by mounting conditions or ambient temperature, etc.

Therefore, please use the relay within $\pm 5\%$ of rated coil voltage.

- "Initial" means the condition of products at the time of delivery.

● Single side stable

Type	Rated coil voltage	Operate voltage* (at 20°C)	Release voltage* (at 20°C)	Rated operating current ($\pm 10\%$, at 20°C)	Coil resistance ($\pm 10\%$, at 20°C)	Rated operating power	Max. allowable voltage (at 50°C)
Standard type (M)	1.5 V DC	Max. 70% V of rated coil voltage (Initial)	Min. 10% V of rated coil voltage (Initial)	266.7 mA	5.63 Ω	400 mW	120% V of rated coil voltage
	3 V DC			133.3 mA	22.5 Ω		
	5 V DC			80 mA	62.5 Ω		
	6 V DC			66.7 mA	90 Ω		
	9 V DC			44.4 mA	203 Ω		
	12 V DC			33.3 mA	360 Ω		
	24 V DC			16.7 mA	1,440 Ω		
	48 V DC			8.3 mA	5,760 Ω		
High sensitive type (S)	1.5 V DC	Max. 80% V of rated coil voltage (Initial)	Min. 10% V of rated coil voltage (Initial)	133.3 mA	11.3 Ω	200 mW	160% V of rated coil voltage
	3 V DC			66.7 mA	45 Ω		
	5 V DC			40 mA	125 Ω		
	6 V DC			33.3 mA	180 Ω		
	9 V DC			22.2 mA	405 Ω		
	12 V DC			16.7 mA	720 Ω		
	24 V DC			8.3 mA	2,880 Ω		
	48 V DC			4.2 mA	11,520 Ω		

*square, pulse drive (JIS C 5442)

● 2 coil latching

Type	Rated coil voltage	Set voltage* (at 20°C)	Reset voltage* (at 20°C)	Rated operating current ($\pm 10\%$, at 20°C)		Coil resistance ($\pm 10\%$, at 20°C)		Rated operating power		Max. allowable voltage (at 50°C)
				Set coil	Reset coil	Set coil	Reset coil	Set coil	Reset coil	
Standard type (M)	1.5 V DC	Max. 70% V of rated coil voltage (Initial)	Max. 70% V of rated coil voltage (Initial)	240 mA	240 mA	6.25 Ω	6.25 Ω	360 mW	360 mW	120% V of rated coil voltage
	3 V DC			120 mA	120 mA	25 Ω	25 Ω			
	5 V DC			72 mA	72 mA	69.4 Ω	69.4 Ω			
	6 V DC			60 mA	60 mA	100 Ω	100 Ω			
	9 V DC			40 mA	40 mA	225 Ω	225 Ω			
	12 V DC			30 mA	30 mA	400 Ω	400 Ω			
	24 V DC			15 mA	15 mA	1,600 Ω	1,600 Ω			
	48 V DC			7.5 mA	7.5 mA	6,400 Ω	6,400 Ω			
High sensitive type (S)	1.5 V DC	Max. 80% V of rated coil voltage (Initial)	Max. 80% V of rated coil voltage (Initial)	120 mA	120 mA	12.5 Ω	12.5 Ω	180 mW	180 mW	160% V of rated coil voltage
	3 V DC			60 mA	60 mA	50 Ω	50 Ω			
	5 V DC			36 mA	36 mA	139 Ω	139 Ω			
	6 V DC			30 mA	30 mA	200 Ω	200 Ω			
	9 V DC			20 mA	20 mA	450 Ω	450 Ω			
	12 V DC			15 mA	15 mA	800 Ω	800 Ω			
	24 V DC			7.5 mA	7.5 mA	3,200 Ω	3,200 Ω			
	48 V DC			3.75 mA	3.75 mA	12,800 Ω	12,800 Ω			

*square, pulse drive (JIS C 5442)

Signal Relays (2A or less) DS RELAYS

■ Specifications

Item		Specifications
Contact data	Contact arrangement	1 Form C
	Contact resistance (initial)	Max. 50 mΩ (by voltage drop 6 V DC 1 A)
	Contact material	Ag+Au clad
	Contact rating (resistive)	2 A 30 V DC
	Max. switching power (resistive)	60 W, 125 VA
	Max. switching voltage	220 V DC, 250 V AC
	Max. switching current	3 A
	Min. switching load (reference value)*1	10 μA 10 mV DC
Insulation resistance (initial)		Min. 100 MΩ (at 500 V DC, Measured portion is the same as the case of dielectric strength.)
Dielectric strength (initial)	Between open contacts	Standard type (M): 1,000 Vrms for 1 min (detection current: 10 mA) High sensitive type (S): 500 Vrms for 1 min (detection current: 10 mA)
	Between contact and coil	Standard type (M): 1,500 Vrms for 1 min (detection current: 10 mA) High sensitive type (S): 1,000 Vrms for 1 min (detection current: 10 mA)
Time characteristics (initial)	Operate [Set] time	Max. 10 ms at rated coil voltage (at 20°C, without bounce) [Max. 10 ms (at 20°C, without bounce)]
	Release [Reset] time	Max. 5 ms at rated coil voltage (at 20°C, without bounce, without diode) [Max. 10 ms (at 20°C, without bounce)]
Shock resistance	Functional	490 m/s ² (half-sine shock pulse: 11 ms, detection time: 10 μs)
	Destructive	980 m/s ² (half-sine shock pulse: 6 ms)
Vibration resistance	Functional	10 to 55 Hz (at double amplitude of: 3.3 mm, detection time: 10 μs)
	Destructive	10 to 55 Hz (at double amplitude of: 5 mm)
Expected life	Mechanical life	Single side stable: Min. 10 ⁸ Latching: Min. 10 ⁷ (at 600 times/min)
Conditions	Conditions for usage, transport and storage*2	Ambient temperature: -40 to +70°C Humidity: 5 to 85% RH (Avoid icing and condensation)
Unit weight		Approx. 3 g

*1. This value is a rough indication of the lower limit at which switching is possible at micro load level.

This value can change due to the switching frequency, environmental conditions, and desired reliability level, therefore it is recommended to check this with the actual load.
TX/TX-S/TX-D relay AgPd contact type are available for low level load analog circuit (10 V DC, 10 mA max. level).

*2. For ambient temperature, please refer to the "GUIDELINES FOR RELAY USAGE".

■ Electrical life

Conditions: Resistive load, at 60 times/min.

Type	Switching capacity	Number of operations
1 Form C	2 A 30 V DC	Min. 5 x 10 ⁶

REFERENCE DATA

1. Max. switching capacity

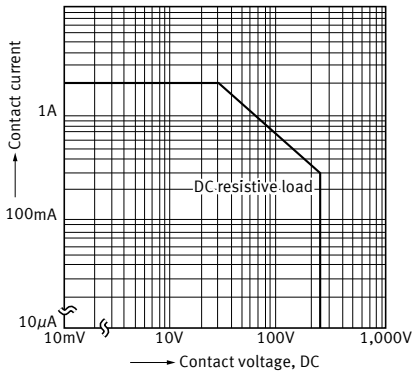

2. Switching life curve

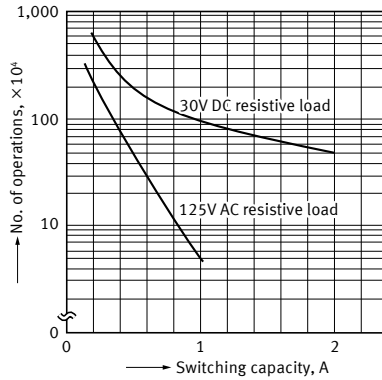

3. Coil temperature rise value (High sensitive Single side stable)

Tested sample : AG231344 5 pcs.
Point measured : Inside the Coil
Contact current : 0A, 2A, 3A
Ambient temperature : 25°C

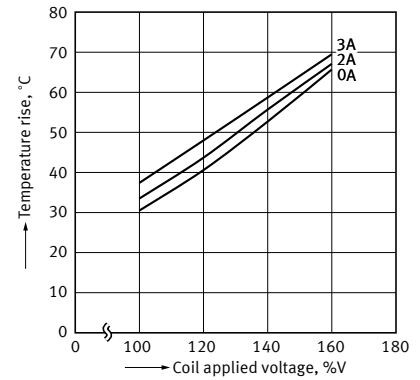

4. Mechanical life (High sensitivity Single side stable)

Tested sample : AG231344 6 pcs.
Operating speed : 1,800 cpm.

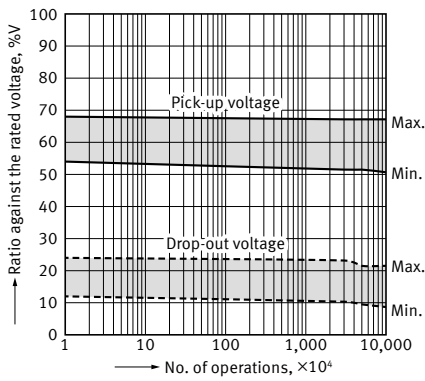

5. Influence of proximity mounting

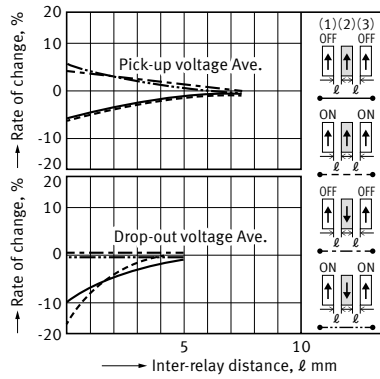

6. Contact reliability test

Operating speed : 20 cpm.
Detection level : 200 mΩ

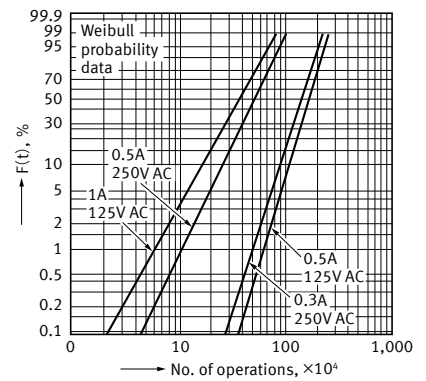

Signal Relays (2A or less) DS RELAYS

DIMENSIONS

CAD The CAD data of the products with a "CAD" mark can be downloaded from our Website.

Unit: mm

● Single side stable/2 coil latching

CAD

External dimensions

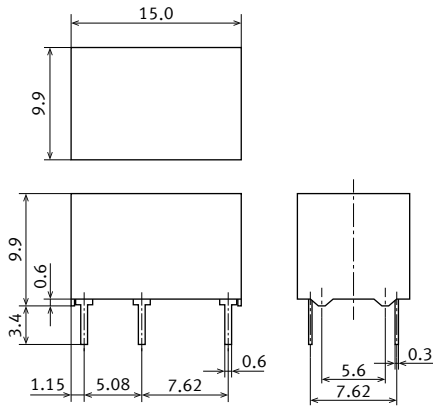

General tolerance : ± 0.3

Suggested PC board pattern

(BOTTOM VIEW)
Single side stable

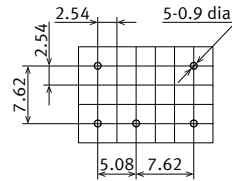

General tolerance : ± 0.1

2 coil latching

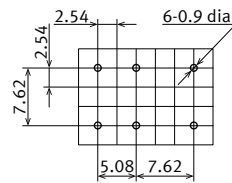

General tolerance : ± 0.1

Schematic
(BOTTOM VIEW)
Single side stable
(Deenergized condition)

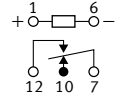

2 coil latching
(Reset condition)

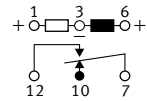

SAFETY STANDARDS

■ UL/C-UL (Recognized)

File No.	Contact rating	Operations	Ambient temperature
E43149	2 A 30 V DC Resistive	10 ⁵	40°C
	0.6 A 110 V DC Resistive	10 ⁵	40°C
	0.6 A 125 V AC General use	10 ⁵	40°C

■ CSA (Certified)

File No.	Contact rating (Certified)	Operations	Ambient temperature
LR26550 etc.	2 A 30 V DC	10 ⁵	40°C
	0.6 A 110 V DC	10 ⁵	40°C
	0.6 A 125 V AC	10 ⁵	40°C

GUIDELINES FOR USAGE

■ For cautions for use, please read "GUIDELINES FOR SIGNAL RELAYS USAGE" and "GUIDELINES FOR RELAY USAGE".

■ Cautions for usage of DS relay

● Latching

- Use latching when conditions involve continuous carrying current.
- Regarding the set and reset pulse time, for the purpose of reliable operation under ambient temperature fluctuations and different operating conditions, we recommend setting the coil applied set and reset pulse time to 10 ms or more at the rated coil voltage.
- The relay is shipped in the reset position. But jolts during transport or impacts during installation can change the reset position. It is, therefore, advisable to build a circuit in which the relay can be initialized (set and reset) just after turning on the power.

Please refer to "the latest product specifications" when designing your product.

•Requests to customers:

<https://industrial.panasonic.com/ac/e/salespolicies/>

GUIDELINES FOR RELAY USAGE

■ For cautions for use, please read "GUIDELINES FOR RELAY USAGE".

https://industrial.panasonic.com/ac/e/control/relay/cautions_use/index.jsp

PRECAUTIONS FOR COIL INPUT

■ Long term current carrying

A circuit that will be carrying a current continuously for long periods without relay switching operation. (circuits for emergency lamps, alarm devices and error inspection that, for example, revert only during malfunction and output warnings with form B contacts)

Continuous, long-term current to the coil will facilitate deterioration of coil insulation and characteristics due to heating of the coil itself. For circuits such as these, please use a magnetic-hold type latching relay. If you need to use a single stable relay, use a sealed type relay that is not easily affected by ambient conditions and make a failsafe circuit design that considers the possibility of contact failure or disconnection.

■ DC Coil operating power

Steady state DC current should be applied to the coil.

The wave form should be rectangular. If it includes ripple, the ripple factor should be less than 5%. However, please check with the actual circuit since the electrical characteristics may vary.

The rated coil voltage should be applied to the coil and the set/reset pulse time of latching type relay differs for each relays, please refer to the relay's individual specifications.

■ Coil connection

When connecting coils of polarized relays, please check coil polarity(+,-) at the internal connection diagram (Schematic). If any wrong connection is made, it may cause unexpected malfunction, like abnormal heat, fire and so on, and circuit do not work.

Avoid impressing voltages to the set coil and reset coil at the same time.

■ Maximum allowable voltage and temperature rise

Proper usage requires that the rated coil voltage be impressed on the coil.

Note, however, that if a voltage greater than or equal to the maximum continuous voltage is impressed on the coil, the coil may burn or its layers short due to the temperature rise.

Furthermore, do not exceed the usable ambient temperature range listed in the catalog.

● Temperature rise due to pulse voltage

When a pulse voltage with ON time of less than 2 minutes is used, the coil temperature rise bears no relationship to the ON time.

This varies with the ratio of ON time to OFF time, and compared with continuous current passage, it is rather small.

The various relays are essentially the same in this respect.

Current passage time	%
For continuous passage	Temperature rise value is 100%
ON : OFF = 3 : 1	About 80%
ON : OFF = 1 : 1	About 50%
ON : OFF = 1 : 3	About 35%

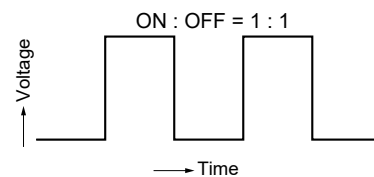

● Operate voltage change due to coil temperature rise (hot start)

In DC relays, after continuous passage of current in the coil, if the current is turned OFF, then immediately turned ON again, due to the temperature rise in the coil, the operate voltage will become somewhat higher. Also, it will be the same as using it in a higher temperature atmosphere.

The resistance/temperature relationship for copper wire is about 0.4% for 1°C, and with this ratio the coil resistance increases.

That is, in order to operate of the relay, it is necessary that the voltage be higher than the operate voltage and the operate voltage rises in accordance with the increase in the resistance value.

However, for some polarized relays, this rate of change is considerably smaller.

NOTES

■ Usage, Storage, and Transport Conditions

During usage, storage, or transportation, avoid locations subject to direct sunlight and maintain normal temperature, humidity, and pressure conditions.

The allowable specifications for environments suitable for usage, storage, and transportation are given below.

1) Temperature: The allowable temperature range differs for each relay, so refer to the relay's individual specifications. In addition, when transporting or storing relays while they are tube packaged, there are cases when the temperature may differ from the allowable range. In this situation, be sure to consult the individual specifications.

2) Humidity: 5 to 85% RH

The humidity range varies with the temperature.
Use within the range indicated in the graph.
(The allowable temperature depends on the relays.)

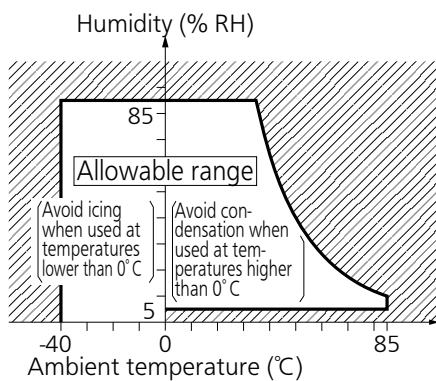

3) Pressure: 86 to 106 kPa

● Condensation

Condensation occurs when the ambient temperature drops suddenly from a high temperature and humidity, or the relay and microwave device is suddenly transferred from a low ambient temperature to a high temperature and humidity.

Condensation causes the failures like insulation deterioration, wire disconnection and rust etc.

Panasonic Corporation does not guarantee the failures caused by condensation.

The heat conduction by the equipment may accelerate the cooling of device itself, and the condensation may occur.

Please conduct product evaluations in the worst condition of the actual usage. (Special attention should be paid when high temperature heating parts are close to the device. Also please consider the condensation may occur inside of the device.)

● Icing

Condensation or other moisture may freeze on relays when the temperature become lower than 0°C.

This icing causes the sticking of movable portion, the operation delay and the contact conduction failure etc.

Panasonic Corporation does not guarantee the failures caused by the icing.

The heat conduction by the equipment may accelerate the cooling of relay itself and the icing may occur.

Please conduct product evaluations in the worst condition of the actual usage.

● Low temperature and low humidity

The plastic becomes brittle if the switch is exposed to a low temperature, low humidity environment for long periods of time.

● High temperature and high humidity

Storage for extended periods of time (including transportation periods) at high temperature or high humidity levels or in atmospheres with organic gases or sulfide gases may cause a sulfide film or oxide film to form on the surfaces of the contacts and/or it may interfere with the functions.

Check out the atmosphere in which the units are to be stored and transported.

● Package

In terms of the packing format used, make every effort to keep the effects of moisture, organic gases and sulfide gases to the absolute minimum.

● Storage requirements

Since the surface-mount terminal type is sensitive to humidity it is packaged with tightly sealed anti-humidity packaging. However, when storing, please be careful of the following.

- 1) Please use promptly once the anti-humidity pack is opened. (within 72 hours, Max. 30°C / 70% RH).
If left with the pack open, the relay will absorb moisture which will cause thermal stress when reflow mounting and thus cause the case to expand. As a result, the seal may break.
- 2) If relays will not be used within 72 hours, please store relays in a humidity controlled desiccator or in an anti-humidity bag to which silica gel has been added.

* If the relay is to be soldered after it has been exposed to excessive humidity atmosphere, cracks and leaks can occur.
Be sure to mount the relay under the required mounting conditions.

- 3) When relays (which is packaged with humidity indicator and silica gel) meeting one of below criteria, please bake (dry) before use.
 - When the storage conditions specified in 1) are exceeded.
 - When humidity indicator is in III or IV status according to judgement standard.

<How to judge>

Please check humidity indicator color and decide if baking is necessary or not.

● : indicate brown, ○ : Other than brown (blueish color)

	5%	10%	60%	Bake treatment necessity judgment
I	●	●	●	No need to bake
II	○	●	●	No need to bake
III	○	○	●	Need to bake
IV	○	○	○	Need to bake

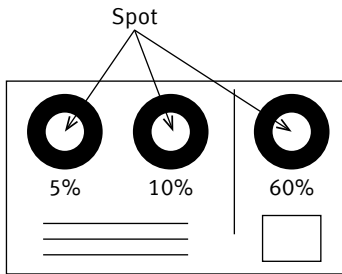

Humidity indicator card

<Baking (Drying) conditions>

- With reel : 45°C, 96 hours or more.

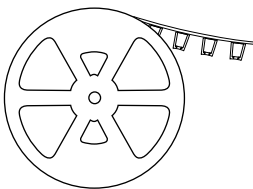

- Without reel (including relay only) : 60°C, 35 hours or more.

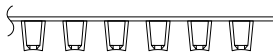

- 4) The following cautionary label is affixed to the anti-humidity pack.

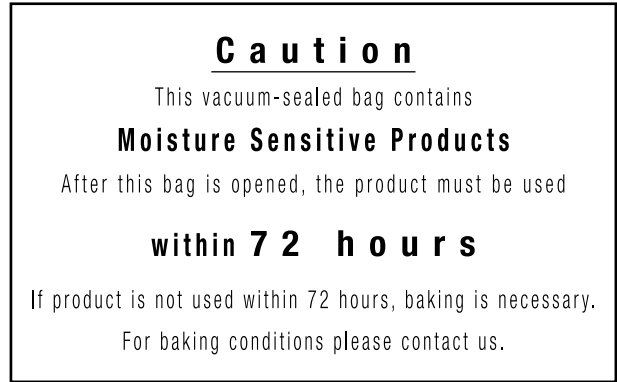

● Silicon

When a source of silicone substances (silicone rubber, silicone oil, silicone coating materials and silicone filling materials etc.) is used around the relay, the silicone gas (low molecular siloxane etc.) may be produced

This silicone gas may penetrate into the inside of the relay. When the relay is kept and used in this condition, silicone compound may adhere to the relay contacts which may cause the contact failure.

Do not use any sources of silicone gas around the relay (Including plastic seal types).

● NOx Generation

When relay is used in an atmosphere high in humidity to switch a load which easily produces an arc, the NOx created by the arc and the water absorbed from outside the relay combine to produce nitric acid.

This corrodes the internal metal parts and adversely affects operation.

Avoid use at an ambient humidity of 85% RH or higher (at 20°C).

If use at high humidity is unavoidable, please contact our sales representative.

OTHERS

■Cleaning

- 1) Although the environmentally sealed type relay (plastic sealed type, etc.) can be cleaned, avoid immersing the relay into cold liquid (such as cleaning solvent) immediately after soldering. Doing so may deteriorate the sealing performance.
- 2) Surface-mount terminal type relay is sealed type and it can be cleaned by immersion.
Use pure water or alcohol-based cleaning solvent.
- 3) Cleaning with the boiling method is recommended (The temperature of cleaning liquid should be 40°C or lower). Avoid ultrasonic cleaning on relays.
Use of ultrasonic cleaning may cause breaks in the coil or slight sticking of the contacts due to the ultrasonic energy.

Please refer to **"the latest product specifications"** when designing your product.

•Requests to customers:

<https://industrial.panasonic.com/ac/e/salespolicies/>

Please contact

Panasonic Corporation

Electromechanical Control Business Division

■1006, Oaza Kadoma, Kadoma-shi, Osaka 571-8506, Japan
industrial.panasonic.com/ac/e/

Panasonic[®]

©Panasonic Corporation 2020