



## Miniature Basic Switch

# Miniature Basic Switch that Offers High Reliability and Security

- Wide variation of best-selling microswitches with switching currents of 10 to 21 A.
- Can be used for interrupting current when doors are opened or closed.
- Available in two types of cases: thermoplastic resin and thermosetting resin.

RoHS Compliant

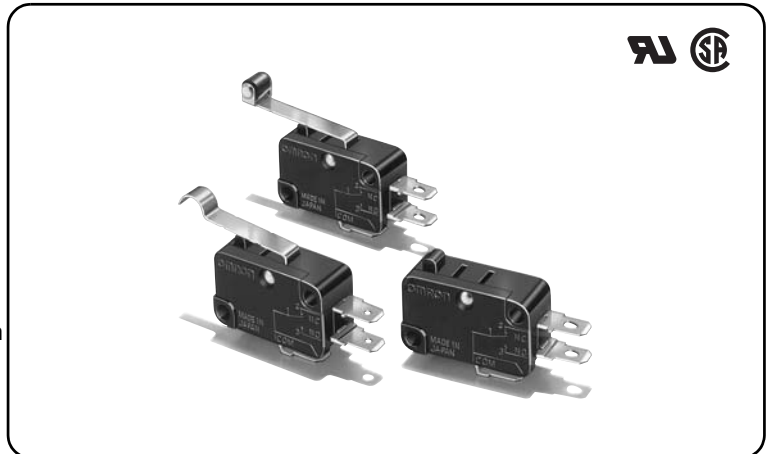

## Model Number Legend

V-1 2 - 3 4 5 6

### 1. Ratings

- 21: 21 A at 250 VAC
- 16: 16 A at 250 VAC
- 15: 15 A at 250 VAC
- 10: 10 A at 250 VAC

### 2. Actuator

- None : Pin plunger
- 1 : Short hinge lever
- 2 : Hinge lever
- 3 : Long hinge lever
- 4 : Simulated roller lever
- 5 : Short hinge roller lever
- 6 : Hinge roller lever

### 3. Contact Form

- 1: SPDT
- 2: SPST-NC
- 3: SPST-NO

### 4. Terminals

- A : Solder terminals
- C2 : Quick-connect terminals (#187)
- C : Quick-connect terminals (#250)

### 5. Maximum Operating Force

- 6: 3.92 N {400 gf}
  - 5: 1.96 N {200 gf}
  - 4: 0.98 N {100 gf}
- Note: These values are for the pin plunger models.

### 6. Heat Resistance



- None : Standard (80°C)
- T : Heat-resistive (150°C)

## List of Models



### Thermoplastic Case

| Actuator   | Terminals                           | Contact form | Maximum operating force (OF) | Ratings         |                  |
|--|-------------------------------------|--------------|------------------------------|-----------------|------------------|
|  |                                     |              |                              | 21A             | 16A              |
| Pin plunger<br> | Solder terminals (A)                | SPDT         | 3.92N                        | ---             | <b>V-16-1A6</b>  |
|  |                                     | SPST-NC      |                              | ---             | <b>V-16-2A6</b>  |
|  |                                     | SPST-NO      |                              | ---             | <b>V-16-3A6</b>  |
|  |                                     | SPDT         | 1.96N                        | ---             | <b>V-16-1A5</b>  |
|  |                                     | SPST-NC      |                              | ---             | <b>V-16-2A5</b>  |
|  |                                     | SPST-NO      |                              | ---             | <b>V-16-3A5</b>  |
|  |                                     | SPDT         | 0.98N                        | ---             | ---              |
|  |                                     | SPST-NC      |                              | ---             | ---              |
|  |                                     | SPST-NO      |                              | ---             | ---              |
|  | Quick-connect terminals (#187) (C2) | SPDT         | 3.92N                        | ---             | <b>V-16-1C26</b> |
|  |                                     | SPST-NC      |                              | ---             | <b>V-16-2C26</b> |
|  |                                     | SPST-NO      |                              | ---             | <b>V-16-3C26</b> |
|  |                                     | SPDT         | 1.96N                        | ---             | <b>V-16-1C25</b> |
|  |                                     | SPST-NC      |                              | ---             | <b>V-16-2C25</b> |
|  |                                     | SPST-NO      |                              | ---             | <b>V-16-3C25</b> |
|  |                                     | SPDT         | 0.98N                        | ---             | ---              |
|  |                                     | SPST-NC      |                              | ---             | ---              |
|  |                                     | SPST-NO      |                              | ---             | ---              |
|  | Quick-connect terminals (#250) (C)  | SPDT         | 3.92N                        | <b>V-21-1C6</b> | <b>V-16-1C6</b>  |
|  |                                     | SPST-NC      |                              | <b>V-21-2C6</b> | <b>V-16-2C6</b>  |
|  |                                     | SPST-NO      |                              | <b>V-21-3C6</b> | <b>V-16-3C6</b>  |
|  |                                     | SPDT         | 1.96N                        | ---             | <b>V-16-1C5</b>  |
|  |                                     | SPST-NC      |                              | ---             | <b>V-16-2C5</b>  |
|  |                                     | SPST-NO      |                              | ---             | <b>V-16-3C5</b>  |
| SPDT   |                                     | 0.98N        | ---                          | ---             |                  |
| SPST-NC  |                                     |              | ---                          | ---             |                  |
| SPST-NO  |                                     |              | ---                          | ---             |                  |



Refer to "**Micro Switch Common Accessories**" for Separators (sold separately), Actuators (sold separately) and Terminal Connectors (sold separately).

| Actuator   | Terminals                           | Contact form | Ratings                      |           |            |
|--|-------------------------------------|--------------|------------------------------|-----------|------------|
|  |                                     |              | Maximum operating force (OF) | 21A       | 16A        |
| Short hinge lever<br> | Solder terminals (A)                | SPDT         | 3.92N                        | ---       | V-161-1A6  |
|  |                                     | SPST-NC      |                              | ---       | V-161-2A6  |
|  |                                     | SPST-NO      |                              | ---       | V-161-3A6  |
|  |                                     | SPDT         | 1.96N                        | ---       | V-161-1A5  |
|  |                                     | SPST-NC      |                              | ---       | V-161-2A5  |
|  |                                     | SPST-NO      |                              | ---       | V-161-3A5  |
|  |                                     | SPDT         | 0.98N                        | ---       | ---        |
|  |                                     | SPST-NC      |                              | ---       | ---        |
|  |                                     | SPST-NO      |                              | ---       | ---        |
|  | Quick-connect terminals (#187) (C2) | SPDT         | 3.92N                        | ---       | V-161-1C26 |
|  |                                     | SPST-NC      |                              | ---       | V-161-2C26 |
|  |                                     | SPST-NO      |                              | ---       | V-161-3C26 |
|  |                                     | SPDT         | 1.96N                        | ---       | V-161-1C25 |
|  |                                     | SPST-NC      |                              | ---       | V-161-2C25 |
|  |                                     | SPST-NO      |                              | ---       | V-161-3C25 |
|  |                                     | SPDT         | 0.98N                        | ---       | ---        |
|  |                                     | SPST-NC      |                              | ---       | ---        |
|  |                                     | SPST-NO      |                              | ---       | ---        |
|  | Quick-connect terminals (#250) (C)  | SPDT         | 3.92N                        | V-211-1C6 | V-161-1C6  |
|  |                                     | SPST-NC      |                              | V-211-2C6 | V-161-2C6  |
|  |                                     | SPST-NO      |                              | V-211-3C6 | V-161-3C6  |
|  |                                     | SPDT         | 1.96N                        | ---       | V-161-1C5  |
|  |                                     | SPST-NC      |                              | ---       | V-161-2C5  |
|  |                                     | SPST-NO      |                              | ---       | V-161-3C5  |
| SPDT   |                                     | 0.98N        | ---                          | ---       |            |
| SPST-NC  |                                     |              | ---                          | ---       |            |
| SPST-NO  |                                     |              | ---                          | ---       |            |
| Hinge lever<br>     | Solder terminals (A)                | SPDT         | 2.45N                        | ---       | V-162-1A6  |
|  |                                     | SPST-NC      |                              | ---       | V-162-2A6  |
|  |                                     | SPST-NO      |                              | ---       | V-162-3A6  |
|  |                                     | SPDT         | 1.23N                        | ---       | V-162-1A5  |
|  |                                     | SPST-NC      |                              | ---       | V-162-2A5  |
|  |                                     | SPST-NO      |                              | ---       | V-162-3A5  |
|  |                                     | SPDT         | 0.59N                        | ---       | ---        |
|  |                                     | SPST-NC      |                              | ---       | ---        |
|  |                                     | SPST-NO      |                              | ---       | ---        |
|  | Quick-connect terminals (#187) (C2) | SPDT         | 2.45N                        | ---       | V-162-1C26 |
|  |                                     | SPST-NC      |                              | ---       | V-162-2C26 |
|  |                                     | SPST-NO      |                              | ---       | V-162-3C26 |
|  |                                     | SPDT         | 1.23N                        | ---       | V-162-1C25 |
|  |                                     | SPST-NC      |                              | ---       | V-162-2C25 |
|  |                                     | SPST-NO      |                              | ---       | V-162-3C25 |
|  |                                     | SPDT         | 0.59N                        | ---       | ---        |
|  |                                     | SPST-NC      |                              | ---       | ---        |
|  |                                     | SPST-NO      |                              | ---       | ---        |
|  | Quick-connect terminals (#250) (C)  | SPDT         | 2.45N                        | V-212-1C6 | V-162-1C6  |
|  |                                     | SPST-NC      |                              | V-212-2C6 | V-162-2C6  |
|  |                                     | SPST-NO      |                              | V-212-3C6 | V-162-3C6  |
|  |                                     | SPDT         | 1.23N                        | ---       | V-162-1C5  |
|  |                                     | SPST-NC      |                              | ---       | V-162-2C5  |
|  |                                     | SPST-NO      |                              | ---       | V-162-3C5  |
| SPDT   |                                     | 0.59N        | ---                          | ---       |            |
| SPST-NC  |                                     |              | ---                          | ---       |            |
| SPST-NO  |                                     |              | ---                          | ---       |            |

Refer to "Micro Switch Common Accessories" for Separators (sold separately), Actuators (sold separately) and Terminal Connectors (sold separately).



| Actuator  | Terminals                           | Contact form | Maximum operating force (OF) | Ratings   |            |
|---|-------------------------------------|--------------|------------------------------|-----------|------------|
|   |                                     |              |                              | 21A       | 16A        |
| Long hinge lever<br>         | Solder terminals (A)                | SPDT         | 1.27N                        | ---       | V-163-1A6  |
|   |                                     | SPST-NC      |                              | ---       | V-163-2A6  |
|   |                                     | SPST-NO      |                              | ---       | V-163-3A6  |
|   |                                     | SPDT         | 0.69N                        | ---       | V-163-1A5  |
|   |                                     | SPST-NC      |                              | ---       | V-163-2A5  |
|   |                                     | SPST-NO      |                              | ---       | V-163-3A5  |
|   |                                     | SPDT         | 0.34N                        | ---       | ---        |
|   |                                     | SPST-NC      |                              | ---       | ---        |
|   |                                     | SPST-NO      |                              | ---       | ---        |
|   | Quick-connect terminals (#187) (C2) | SPDT         | 1.27N                        | ---       | V-163-1C26 |
|   |                                     | SPST-NC      |                              | ---       | V-163-2C26 |
|   |                                     | SPST-NO      |                              | ---       | V-163-3C26 |
|   |                                     | SPDT         | 0.69N                        | ---       | V-163-1C25 |
|   |                                     | SPST-NC      |                              | ---       | V-163-2C25 |
|   |                                     | SPST-NO      |                              | ---       | V-163-3C25 |
|   |                                     | SPDT         | 0.34N                        | ---       | ---        |
|   |                                     | SPST-NC      |                              | ---       | ---        |
|   |                                     | SPST-NO      |                              | ---       | ---        |
|   | Quick-connect terminals (#250) (C)  | SPDT         | 1.27N                        | V-213-1C6 | V-163-1C6  |
|   |                                     | SPST-NC      |                              | V-213-2C6 | V-163-2C6  |
|   |                                     | SPST-NO      |                              | V-213-3C6 | V-163-3C6  |
|   |                                     | SPDT         | 0.69N                        | ---       | V-163-1C5  |
|   |                                     | SPST-NC      |                              | ---       | V-163-2C5  |
|   |                                     | SPST-NO      |                              | ---       | V-163-3C5  |
| SPDT  |                                     | 0.34N        | ---                          | ---       |            |
| SPST-NC   |                                     |              | ---                          | ---       |            |
| SPST-NO   |                                     |              | ---                          | ---       |            |
| Simulated roller lever<br> | Solder terminals (A)                | SPDT         | 2.45N                        | ---       | V-164-1A6  |
|   |                                     | SPST-NC      |                              | ---       | V-164-2A6  |
|   |                                     | SPST-NO      |                              | ---       | V-164-3A6  |
|   |                                     | SPDT         | 1.23N                        | ---       | V-164-1A5  |
|   |                                     | SPST-NC      |                              | ---       | V-164-2A5  |
|   |                                     | SPST-NO      |                              | ---       | V-164-3A5  |
|   |                                     | SPDT         | 0.59N                        | ---       | ---        |
|   |                                     | SPST-NC      |                              | ---       | ---        |
|   |                                     | SPST-NO      |                              | ---       | ---        |
|   | Quick-connect terminals (#187) (C2) | SPDT         | 2.45N                        | ---       | V-164-1C26 |
|   |                                     | SPST-NC      |                              | ---       | V-164-2C26 |
|   |                                     | SPST-NO      |                              | ---       | V-164-3C26 |
|   |                                     | SPDT         | 1.23N                        | ---       | V-164-1C25 |
|   |                                     | SPST-NC      |                              | ---       | V-164-2C25 |
|   |                                     | SPST-NO      |                              | ---       | V-164-3C25 |
|   |                                     | SPDT         | 0.59N                        | ---       | ---        |
|   |                                     | SPST-NC      |                              | ---       | ---        |
|   |                                     | SPST-NO      |                              | ---       | ---        |
|   | Quick-connect terminals (#250) (C)  | SPDT         | 2.45N                        | V-214-1C6 | V-164-1C6  |
|   |                                     | SPST-NC      |                              | V-214-2C6 | V-164-2C6  |
|   |                                     | SPST-NO      |                              | V-214-3C6 | V-164-3C6  |
|   |                                     | SPDT         | 1.23N                        | ---       | V-164-1C5  |
|   |                                     | SPST-NC      |                              | ---       | V-164-2C5  |
|   |                                     | SPST-NO      |                              | ---       | V-164-3C5  |
| SPDT  |                                     | 0.59N        | ---                          | ---       |            |
| SPST-NC   |                                     |              | ---                          | ---       |            |
| SPST-NO   |                                     |              | ---                          | ---       |            |

Refer to "Micro Switch Common Accessories" for Separators (sold separately), Actuators (sold separately) and Terminal Connectors (sold separately).



| Actuator  | Terminals                           | Contact form | Maximum operating force (OF) | Ratings   |            |
|---|-------------------------------------|--------------|------------------------------|-----------|------------|
|   |                                     |              |                              | 21A       | 16A        |
| Short hinge roller lever<br> | Solder terminals (A)                | SPDT         | 4.71N                        | ---       | V-165-1A6  |
|   |                                     | SPST-NC      |                              | ---       | V-165-2A6  |
|   |                                     | SPST-NO      |                              | ---       | V-165-3A6  |
|   |                                     | SPDT         | 2.35N                        | ---       | V-165-1A5  |
|   |                                     | SPST-NC      |                              | ---       | V-165-2A5  |
|   |                                     | SPST-NO      |                              | ---       | V-165-3A5  |
|   |                                     | SPDT         | 1.18N                        | ---       | ---        |
|   |                                     | SPST-NC      |                              | ---       | ---        |
|   |                                     | SPST-NO      |                              | ---       | ---        |
|   | Quick-connect terminals (#187) (C2) | SPDT         | 4.71N                        | ---       | V-165-1C26 |
|   |                                     | SPST-NC      |                              | ---       | V-165-2C26 |
|   |                                     | SPST-NO      |                              | ---       | V-165-3C26 |
|   |                                     | SPDT         | 2.35N                        | ---       | V-165-1C25 |
|   |                                     | SPST-NC      |                              | ---       | V-165-2C25 |
|   |                                     | SPST-NO      |                              | ---       | V-165-3C25 |
|   |                                     | SPDT         | 1.18N                        | ---       | ---        |
|   |                                     | SPST-NC      |                              | ---       | ---        |
|   |                                     | SPST-NO      |                              | ---       | ---        |
|   | Quick-connect terminals (#250) (C)  | SPDT         | 4.71N                        | V-215-1C6 | V-165-1C6  |
|   |                                     | SPST-NC      |                              | V-215-2C6 | V-165-2C6  |
|   |                                     | SPST-NO      |                              | V-215-3C6 | V-165-3C6  |
|   |                                     | SPDT         | 2.35N                        | ---       | V-165-1C5  |
|   |                                     | SPST-NC      |                              | ---       | V-165-2C5  |
|   |                                     | SPST-NO      |                              | ---       | V-165-3C5  |
| SPDT  |                                     | 1.18N        | ---                          | ---       |            |
| SPST-NC   |                                     |              | ---                          | ---       |            |
| SPST-NO   |                                     |              | ---                          | ---       |            |
| Hinge roller lever<br>     | Solder terminals (A)                | SPDT         | 2.45N                        | ---       | V-166-1A6  |
|   |                                     | SPST-NC      |                              | ---       | V-166-2A6  |
|   |                                     | SPST-NO      |                              | ---       | V-166-3A6  |
|   |                                     | SPDT         | 1.23N                        | ---       | V-166-1A5  |
|   |                                     | SPST-NC      |                              | ---       | V-166-2A5  |
|   |                                     | SPST-NO      |                              | ---       | V-166-3A5  |
|   |                                     | SPDT         | 0.59N                        | ---       | ---        |
|   |                                     | SPST-NC      |                              | ---       | ---        |
|   |                                     | SPST-NO      |                              | ---       | ---        |
|   | Quick-connect terminals (#187) (C2) | SPDT         | 2.45N                        | ---       | V-166-1C26 |
|   |                                     | SPST-NC      |                              | ---       | V-166-2C26 |
|   |                                     | SPST-NO      |                              | ---       | V-166-3C26 |
|   |                                     | SPDT         | 1.23N                        | ---       | V-166-1C25 |
|   |                                     | SPST-NC      |                              | ---       | V-166-2C25 |
|   |                                     | SPST-NO      |                              | ---       | V-166-3C25 |
|   |                                     | SPDT         | 0.59N                        | ---       | ---        |
|   |                                     | SPST-NC      |                              | ---       | ---        |
|   |                                     | SPST-NO      |                              | ---       | ---        |
|   | Quick-connect terminals (#250) (C)  | SPDT         | 2.45N                        | V-216-1C6 | V-166-1C6  |
|   |                                     | SPST-NC      |                              | V-216-2C6 | V-166-2C6  |
|   |                                     | SPST-NO      |                              | V-216-3C6 | V-166-3C6  |
|   |                                     | SPDT         | 1.23N                        | ---       | V-166-1C5  |
|   |                                     | SPST-NC      |                              | ---       | V-166-2C5  |
|   |                                     | SPST-NO      |                              | ---       | V-166-3C5  |
| SPDT  |                                     | 0.59N        | ---                          | ---       |            |
| SPST-NC   |                                     |              | ---                          | ---       |            |
| SPST-NO   |                                     |              | ---                          | ---       |            |

Refer to "Micro Switch Common Accessories" for Separators (sold separately), Actuators (sold separately) and Terminal Connectors (sold separately).

Thermosetting case



| Actuator   | Terminals                           | Contact form | Ratings<br>Maximum operating force (OF) | 15A        | 10A        | Heat-resistive |              |
|--|-------------------------------------|--------------|---|------------|------------|----------------|--------------|
|  |                                     |              |   |            |            | 15A            | 10A          |
| Pin plunger<br>         | Solder terminals (A)                | SPDT         | 3.92N                                   | V-15-1A6   | ---        | V-15-1A6-T     | ---          |
|  |                                     | SPST-NC      |   | V-15-2A6   | ---        | ---            | ---          |
|  |                                     | SPST-NO      |   | V-15-3A6   | ---        | ---            | ---          |
|  |                                     | SPDT         | 1.96N                                   | V-15-1A5   | V-10-1A5   | V-15-1A5-T     | V-10-1A5-T   |
|  |                                     | SPST-NC      |   | V-15-2A5   | V-10-2A5   | ---            | ---          |
|  |                                     | SPST-NO      |   | V-15-3A5   | V-10-3A5   | ---            | ---          |
|  |                                     | SPDT         | 0.98N                                   | ---        | V-10-1A4   | ---            | V-10-1A4-T   |
|  |                                     | SPST-NC      |   | ---        | V-10-2A4   | ---            | V-10-2A4-T   |
|  |                                     | SPST-NO      |   | ---        | V-10-3A4   | ---            | V-10-3A4-T   |
|  | Quick-connect terminals (#187) (C2) | SPDT         | 3.92N                                   | V-15-1C26  | ---        | V-15-1C26-T    | ---          |
|  |                                     | SPST-NC      |   | V-15-2C26  | ---        | ---            | ---          |
|  |                                     | SPST-NO      |   | V-15-3C26  | ---        | ---            | ---          |
|  |                                     | SPDT         | 1.96N                                   | V-15-1C25  | V-10-1C25  | V-15-1C25-T    | V-10-1C25-T  |
|  |                                     | SPST-NC      |   | V-15-2C25  | V-10-2C25  | ---            | ---          |
|  |                                     | SPST-NO      |   | V-15-3C25  | V-10-3C25  | ---            | ---          |
|  |                                     | SPDT         | 0.98N                                   | ---        | V-10-1C24  | ---            | V-10-1C24-T  |
|  |                                     | SPST-NC      |   | ---        | V-10-2C24  | ---            | ---          |
|  |                                     | SPST-NO      |   | ---        | V-10-3C24  | ---            | ---          |
|  | Quick-connect terminals (#250) (C)  | SPDT         | 3.92N                                   | V-15-1C6   | ---        | V-15-1C6-T     | ---          |
|  |                                     | SPST-NC      |   | V-15-2C6   | ---        | ---            | ---          |
|  |                                     | SPST-NO      |   | V-15-3C6   | ---        | ---            | ---          |
|  |                                     | SPDT         | 1.96N                                   | V-15-1C5   | V-10-1C5   | V-15-1C5-T     | V-10-1C5-T   |
|  |                                     | SPST-NC      |   | V-15-2C5   | V-10-2C5   | ---            | ---          |
|  |                                     | SPST-NO      |   | V-15-3C5   | V-10-3C5   | ---            | ---          |
| SPDT   |                                     | 0.98N        | ---                                     | V-10-1C4   | ---        | V-10-1C4-T     |              |
| SPST-NC  |                                     |              | ---                                     | V-10-2C4   | ---        | ---            |              |
| SPST-NO  |                                     |              | ---                                     | V-10-3C4   | ---        | ---            |              |
| Short hinge lever<br> | Solder terminals (A)                | SPDT         | 3.92N                                   | V-151-1A6  | ---        | V-151-1A6-T    | ---          |
|  |                                     | SPST-NC      |   | V-151-2A6  | ---        | ---            | ---          |
|  |                                     | SPST-NO      |   | V-151-3A6  | ---        | ---            | ---          |
|  |                                     | SPDT         | 1.96N                                   | V-151-1A5  | V-101-1A5  | V-151-1A5-T    | V-101-1A5-T  |
|  |                                     | SPST-NC      |   | V-151-2A5  | V-101-2A5  | ---            | ---          |
|  |                                     | SPST-NO      |   | V-151-3A5  | V-101-3A5  | ---            | ---          |
|  |                                     | SPDT         | 0.98N                                   | ---        | V-101-1A4  | ---            | V-101-1A4-T  |
|  |                                     | SPST-NC      |   | ---        | V-101-2A4  | ---            | ---          |
|  |                                     | SPST-NO      |   | ---        | V-101-3A4  | ---            | ---          |
|  | Quick-connect terminals (#187) (C2) | SPDT         | 3.92N                                   | V-151-1C26 | ---        | V-151-1C26-T   | ---          |
|  |                                     | SPST-NC      |   | V-151-2C26 | ---        | ---            | ---          |
|  |                                     | SPST-NO      |   | V-151-3C26 | ---        | ---            | ---          |
|  |                                     | SPDT         | 1.96N                                   | V-151-1C25 | V-101-1C25 | V-151-1C25-T   | V-101-1C25-T |
|  |                                     | SPST-NC      |   | V-151-2C25 | V-101-2C25 | ---            | ---          |
|  |                                     | SPST-NO      |   | V-151-3C25 | V-101-3C25 | ---            | ---          |
|  |                                     | SPDT         | 0.98N                                   | ---        | V-101-1C24 | ---            | V-101-1C24-T |
|  |                                     | SPST-NC      |   | ---        | V-101-2C24 | ---            | ---          |
|  |                                     | SPST-NO      |   | ---        | V-101-3C24 | ---            | ---          |
|  | Quick-connect terminals (#250) (C)  | SPDT         | 3.92N                                   | V-151-1C6  | ---        | V-151-1C6-T    | ---          |
|  |                                     | SPST-NC      |   | V-151-2C6  | ---        | ---            | ---          |
|  |                                     | SPST-NO      |   | V-151-3C6  | ---        | ---            | ---          |
|  |                                     | SPDT         | 1.96N                                   | V-151-1C5  | V-101-1C5  | V-151-1C5-T    | V-101-1C5-T  |
|  |                                     | SPST-NC      |   | V-151-2C5  | V-101-2C5  | ---            | ---          |
|  |                                     | SPST-NO      |   | V-151-3C5  | V-101-3C5  | ---            | ---          |
| SPDT   |                                     | 0.98N        | ---                                     | V-101-1C4  | ---        | V-101-1C4-T    |              |
| SPST-NC  |                                     |              | ---                                     | V-101-2C4  | ---        | ---            |              |
| SPST-NO  |                                     |              | ---                                     | V-101-3C4  | ---        | ---            |              |

Refer to "Micro Switch Common Accessories" for Separators (sold separately), Actuators (sold separately) and Terminal Connectors (sold separately).

| Actuator  | Terminals                           | Contact form | Ratings<br>Maximum operating force (OF) | 15A        | 10A        | Heat-resistive |              |
|---|-------------------------------------|--------------|---|------------|------------|----------------|--------------|
|   |                                     |              |   |            |            | 15A            | 10A          |
|    | Solder terminals (A)                | SPDT         | 2.45N                                   | V-152-1A6  | ---        | V-152-1A6-T    | ---          |
|   |                                     | SPST-NC      |   | V-152-2A6  | ---        | ---            | ---          |
|   |                                     | SPST-NO      |   | V-152-3A6  | ---        | ---            |              |
|   |                                     | SPDT         | 1.23N                                   | V-152-1A5  | V-102-1A5  | V-152-1A5-T    | V-102-1A5-T  |
|   |                                     | SPST-NC      |   | V-152-2A5  | V-102-2A5  | ---            | ---          |
|   |                                     | SPST-NO      |   | V-152-3A5  | V-102-3A5  | ---            | ---          |
|   |                                     | SPDT         | 0.59N                                   | ---        | V-102-1A4  | ---            | V-102-1A4-T  |
|   |                                     | SPST-NC      |   | ---        | V-102-2A4  | ---            | ---          |
|   |                                     | SPST-NO      |   | ---        | V-102-3A4  | ---            | ---          |
|   | Quick-connect terminals (#187) (C2) | SPDT         | 2.45N                                   | V-152-1C26 | ---        | V-152-1C26-T   | ---          |
|   |                                     | SPST-NC      |   | V-152-2C26 | ---        | ---            | ---          |
|   |                                     | SPST-NO      |   | V-152-3C26 | ---        | ---            | ---          |
|   |                                     | SPDT         | 1.23N                                   | V-152-1C25 | V-102-1C25 | V-152-1C25-T   | V-102-1C25-T |
|   |                                     | SPST-NC      |   | V-152-2C25 | V-102-2C25 | ---            | ---          |
|   |                                     | SPST-NO      |   | V-152-3C25 | V-102-3C25 | ---            | ---          |
|   |                                     | SPDT         | 0.59N                                   | ---        | V-102-1C24 | ---            | V-102-1C24-T |
|   |                                     | SPST-NC      |   | ---        | V-102-2C24 | ---            | ---          |
|   |                                     | SPST-NO      |   | ---        | V-102-3C24 | ---            | ---          |
|   | Quick-connect terminals (#250) (C)  | SPDT         | 2.45N                                   | V-152-1C6  | ---        | V-152-1C6-T    | ---          |
|   |                                     | SPST-NC      |   | V-152-2C6  | ---        | ---            | ---          |
|   |                                     | SPST-NO      |   | V-152-3C6  | ---        | ---            | ---          |
|   |                                     | SPDT         | 1.23N                                   | V-152-1C5  | V-102-1C5  | V-152-1C5-T    | V-102-1C5-T  |
|   |                                     | SPST-NC      |   | V-152-2C5  | V-102-2C5  | ---            | ---          |
|   |                                     | SPST-NO      |   | V-152-3C5  | V-102-3C5  | ---            | ---          |
| SPDT  |                                     | 0.59N        | ---                                     | V-102-1C4  | ---        | V-102-1C4-T    |              |
| SPST-NC   |                                     |              | ---                                     | V-102-2C4  | ---        | ---            |              |
| SPST-NO   |                                     |              | ---                                     | V-102-3C4  | ---        | ---            |              |
|  | Solder terminals (A)                | SPDT         | 1.27N                                   | V-153-1A6  | ---        | V-153-1A6-T    | ---          |
|   |                                     | SPST-NC      |   | V-153-2A6  | ---        | ---            | ---          |
|   |                                     | SPST-NO      |   | V-153-3A6  | ---        | ---            | ---          |
|   |                                     | SPDT         | 0.69N                                   | V-153-1A5  | V-103-1A5  | V-153-1A5-T    | V-103-1A5-T  |
|   |                                     | SPST-NC      |   | V-153-2A5  | V-103-2A5  | ---            | ---          |
|   |                                     | SPST-NO      |   | V-153-3A5  | V-103-3A5  | ---            | ---          |
|   |                                     | SPDT         | 0.34N                                   | ---        | V-103-1A4  | ---            | V-103-1A4-T  |
|   |                                     | SPST-NC      |   | ---        | V-103-2A4  | ---            | ---          |
|   |                                     | SPST-NO      |   | ---        | V-103-3A4  | ---            | ---          |
|   | Quick-connect terminals (#187) (C2) | SPDT         | 1.27N                                   | V-153-1C26 | ---        | V-153-1C26-T   | ---          |
|   |                                     | SPST-NC      |   | V-153-2C26 | ---        | ---            | ---          |
|   |                                     | SPST-NO      |   | V-153-3C26 | ---        | ---            | ---          |
|   |                                     | SPDT         | 0.69N                                   | V-153-1C25 | V-103-1C25 | V-153-1C25-T   | V-103-1C25-T |
|   |                                     | SPST-NC      |   | V-153-2C25 | V-103-2C25 | ---            | ---          |
|   |                                     | SPST-NO      |   | V-153-3C25 | V-103-3C25 | ---            | ---          |
|   |                                     | SPDT         | 0.34N                                   | ---        | V-103-1C24 | ---            | V-103-1C24-T |
|   |                                     | SPST-NC      |   | ---        | V-103-2C24 | ---            | ---          |
|   |                                     | SPST-NO      |   | ---        | V-103-3C24 | ---            | ---          |
|   | Quick-connect terminals (#250) (C)  | SPDT         | 1.27N                                   | V-153-1C6  | ---        | V-153-1C6-T    | ---          |
|   |                                     | SPST-NC      |   | V-153-2C6  | ---        | ---            | ---          |
|   |                                     | SPST-NO      |   | V-153-3C6  | ---        | ---            | ---          |
|   |                                     | SPDT         | 0.69N                                   | V-153-1C5  | V-103-1C5  | V-153-1C5-T    | V-103-1C5-T  |
|   |                                     | SPST-NC      |   | V-153-2C5  | V-103-2C5  | ---            | ---          |
|   |                                     | SPST-NO      |   | V-153-3C5  | V-103-3C5  | ---            | ---          |
| SPDT  |                                     | 0.34N        | ---                                     | V-103-1C4  | ---        | V-103-1C4-T    |              |
| SPST-NC   |                                     |              | ---                                     | V-103-2C4  | ---        | ---            |              |
| SPST-NO   |                                     |              | ---                                     | V-103-3C4  | ---        | ---            |              |

V

Refer to "Micro Switch Common Accessories" for Separators (sold separately), Actuators (sold separately) and Terminal Connectors (sold separately).

| Actuator  | Terminals                           | Contact form | Ratings<br>Maximum operating force (OF) | 15A        | 10A        | Heat-resistive |              |
|---|-------------------------------------|--------------|---|------------|------------|----------------|--------------|
|   |                                     |              |   |            |            | 15A            | 10A          |
| Simulated roller lever<br>     | Solder terminals (A)                | SPDT         | 2.45N                                   | V-154-1A6  | ---        | V-154-1A6-T    | ---          |
|   |                                     | SPST-NC      |   | V-154-2A6  | ---        | ---            | ---          |
|   |                                     | SPST-NO      |   | V-154-3A6  | ---        | ---            |              |
|   |                                     | SPDT         | 1.23N                                   | V-154-1A5  | V-104-1A5  | V-154-1A5-T    | V-104-1A5-T  |
|   |                                     | SPST-NC      |   | V-154-2A5  | V-104-2A5  | ---            | ---          |
|   |                                     | SPST-NO      |   | V-154-3A5  | V-104-3A5  | ---            | ---          |
|   |                                     | SPDT         | 0.59N                                   | ---        | V-104-1A4  | ---            | V-104-1A4-T  |
|   |                                     | SPST-NC      |   | ---        | V-104-2A4  | ---            | ---          |
|   |                                     | SPST-NO      |   | ---        | V-104-3A4  | ---            | ---          |
|   | Quick-connect terminals (#187) (C2) | SPDT         | 2.45N                                   | V-154-1C26 | ---        | V-154-1C26-T   | ---          |
|   |                                     | SPST-NC      |   | V-154-2C26 | ---        | ---            | ---          |
|   |                                     | SPST-NO      |   | V-154-3C26 | ---        | ---            |              |
|   |                                     | SPDT         | 1.23N                                   | V-154-1C25 | V-104-1C25 | V-154-1C25-T   | V-104-1C25-T |
|   |                                     | SPST-NC      |   | V-154-2C25 | V-104-2C25 | ---            | ---          |
|   |                                     | SPST-NO      |   | V-154-3C25 | V-104-3C25 | ---            | ---          |
|   |                                     | SPDT         | 0.59N                                   | ---        | V-104-1C24 | ---            | V-104-1C24-T |
|   |                                     | SPST-NC      |   | ---        | V-104-2C24 | ---            | ---          |
|   |                                     | SPST-NO      |   | ---        | V-104-3C24 | ---            | ---          |
|   | Quick-connect terminals (#250) (C)  | SPDT         | 2.45N                                   | V-154-1C6  | ---        | V-154-1C6-T    | ---          |
|   |                                     | SPST-NC      |   | V-154-2C6  | ---        | ---            |              |
|   |                                     | SPST-NO      |   | V-154-3C6  | ---        | ---            |              |
|   |                                     | SPDT         | 1.23N                                   | V-154-1C5  | V-104-1C5  | V-154-1C5-T    | V-104-1C5-T  |
|   |                                     | SPST-NC      |   | V-154-2C5  | V-104-2C5  | ---            | ---          |
|   |                                     | SPST-NO      |   | V-154-3C5  | V-104-3C5  | ---            | ---          |
| SPDT  |                                     | 0.59N        | ---                                     | V-104-1C4  | ---        | V-104-1C4-T    |              |
| SPST-NC   |                                     |              | ---                                     | V-104-2C4  | ---        | ---            |              |
| SPST-NO   |                                     |              | ---                                     | V-104-3C4  | ---        | ---            |              |
| Short hinge roller lever<br> | Solder terminals (A)                | SPDT         | 4.71N                                   | V-155-1A6  | ---        | V-155-1A6-T    | ---          |
|   |                                     | SPST-NC      |   | V-155-2A6  | ---        | ---            | ---          |
|   |                                     | SPST-NO      |   | V-155-3A6  | ---        | ---            |              |
|   |                                     | SPDT         | 2.35N                                   | V-155-1A5  | V-105-1A5  | V-155-1A5-T    | V-105-1A5-T  |
|   |                                     | SPST-NC      |   | V-155-2A5  | V-105-2A5  | ---            | ---          |
|   |                                     | SPST-NO      |   | V-155-3A5  | V-105-3A5  | ---            | ---          |
|   |                                     | SPDT         | 1.18N                                   | ---        | V-105-1A4  | ---            | V-105-1A4-T  |
|   |                                     | SPST-NC      |   | ---        | V-105-2A4  | ---            | ---          |
|   |                                     | SPST-NO      |   | ---        | V-105-3A4  | ---            | ---          |
|   | Quick-connect terminals (#187) (C2) | SPDT         | 4.71N                                   | V-155-1C26 | ---        | V-155-1C26-T   | ---          |
|   |                                     | SPST-NC      |   | V-155-2C26 | ---        | ---            |              |
|   |                                     | SPST-NO      |   | V-155-3C26 | ---        | ---            |              |
|   |                                     | SPDT         | 2.35N                                   | V-155-1C25 | V-105-1C25 | V-155-1C25-T   | V-105-1C25-T |
|   |                                     | SPST-NC      |   | V-155-2C25 | V-105-2C25 | ---            | ---          |
|   |                                     | SPST-NO      |   | V-155-3C25 | V-105-3C25 | ---            | ---          |
|   |                                     | SPDT         | 1.18N                                   | ---        | V-105-1C24 | ---            | V-105-1C24-T |
|   |                                     | SPST-NC      |   | ---        | V-105-2C24 | ---            | ---          |
|   |                                     | SPST-NO      |   | ---        | V-105-3C24 | ---            | ---          |
|   | Quick-connect terminals (#250) (C)  | SPDT         | 4.71N                                   | V-155-1C6  | ---        | V-155-1C6-T    | ---          |
|   |                                     | SPST-NC      |   | V-155-2C6  | ---        | ---            |              |
|   |                                     | SPST-NO      |   | V-155-3C6  | ---        | ---            |              |
|   |                                     | SPDT         | 2.35N                                   | V-155-1C5  | V-105-1C5  | V-155-1C5-T    | V-105-1C5-T  |
|   |                                     | SPST-NC      |   | V-155-2C5  | V-105-2C5  | ---            | ---          |
|   |                                     | SPST-NO      |   | V-155-3C5  | V-105-3C5  | ---            | ---          |
| SPDT  |                                     | 1.18N        | ---                                     | V-105-1C4  | ---        | V-105-1C4-T    |              |
| SPST-NC   |                                     |              | ---                                     | V-105-2C4  | ---        | ---            |              |
| SPST-NO   |                                     |              | ---                                     | V-105-3C4  | ---        | ---            |              |

Refer to "Micro Switch Common Accessories" for Separators (sold separately), Actuators (sold separately) and Terminal Connectors (sold separately).



| Actuator  | Terminals                           | Contact form | Ratings<br>Maximum operating force (OF) | 15A        | 10A        | Heat-resistive |              |
|---|-------------------------------------|--------------|---|------------|------------|----------------|--------------|
|   |                                     |              |   |            |            | 15A            | 10A          |
| Hinge roller lever<br> | Solder terminals (A)                | SPDT         | 2.45N                                   | V-156-1A6  | ---        | V-156-1A6-T    | ---          |
|   |                                     | SPST-NC      |   | V-156-2A6  | ---        | ---            | ---          |
|   |                                     | SPST-NO      |   | V-156-3A6  | ---        | ---            |              |
|   |                                     | SPDT         | 1.23N                                   | V-156-1A5  | V-106-1A5  | V-156-1A5-T    | V-106-1A5-T  |
|   |                                     | SPST-NC      |   | V-156-2A5  | V-106-2A5  | ---            | ---          |
|   |                                     | SPST-NO      |   | V-156-3A5  | V-106-3A5  | ---            | ---          |
|   |                                     | SPDT         | 0.59N                                   | ---        | V-106-1A4  | ---            | V-106-1A4-T  |
|   |                                     | SPST-NC      |   | ---        | V-106-2A4  | ---            | ---          |
|   |                                     | SPST-NO      |   | ---        | V-106-3A4  | ---            | ---          |
|   | Quick-connect terminals (#187) (C2) | SPDT         | 2.45N                                   | V-156-1C26 | ---        | V-156-1C26-T   | ---          |
|   |                                     | SPST-NC      |   | V-156-2C26 | ---        | ---            | ---          |
|   |                                     | SPST-NO      |   | V-156-3C26 | ---        | ---            |              |
|   |                                     | SPDT         | 1.23N                                   | V-156-1C25 | V-106-1C25 | V-156-1C25-T   | V-106-1C25-T |
|   |                                     | SPST-NC      |   | V-156-2C25 | V-106-2C25 | ---            | ---          |
|   |                                     | SPST-NO      |   | V-156-3C25 | V-106-3C25 | ---            | ---          |
|   |                                     | SPDT         | 0.59N                                   | ---        | V-106-1C24 | ---            | V-106-1C24-T |
|   |                                     | SPST-NC      |   | ---        | V-106-2C24 | ---            | ---          |
|   |                                     | SPST-NO      |   | ---        | V-106-3C24 | ---            | ---          |
|   | Quick-connect terminals (#250) (C)  | SPDT         | 2.45N                                   | V-156-1C6  | ---        | V-156-1C6-T    | ---          |
|   |                                     | SPST-NC      |   | V-156-2C6  | ---        | ---            | ---          |
|   |                                     | SPST-NO      |   | V-156-3C6  | ---        | ---            |              |
|   |                                     | SPDT         | 1.23N                                   | V-156-1C5  | V-106-1C5  | V-156-1C5-T    | V-106-1C5-T  |
|   |                                     | SPST-NC      |   | V-156-2C5  | V-106-2C5  | ---            | ---          |
|   |                                     | SPST-NO      |   | V-156-3C5  | V-106-3C5  | ---            | ---          |
|   |                                     | SPDT         | 0.59N                                   | ---        | V-106-1C4  | ---            | V-106-1C4-T  |
|   |                                     | SPST-NC      |   | ---        | V-106-2C4  | ---            | ---          |
|   |                                     | SPST-NO      |   | ---        | V-106-3C4  | ---            | ---          |

### Contact form

SPDT

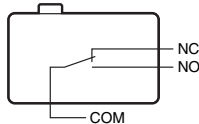

SPST-NC

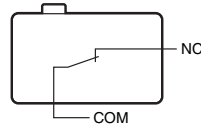

SPST-NO

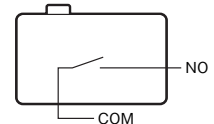

Refer to "**Micro Switch Common Accessories**" for Separators (sold separately), Actuators (sold separately) and Terminal Connectors (sold separately).

## Contact Specifications

| Item                                      | Model                | V-21         | V-16      | V-15      | V-10      |
|---|----------------------|--------------|-----------|-----------|-----------|
| Contact                                   | Specification        | Rivet        |           |           |           |
|   | Material             | Silver alloy |           |           | Silver    |
|   | Gap (standard value) | 1 mm         |           |           |           |
| Inrush current                            | NC                   | 50 A max.    | 40 A max. | 30 A max. | 24 A max. |
|   | NO                   |              |           |           |           |
| Minimum applicable load (reference value) |                      | DC5V 160mA   |           |           |           |

## Ratings

| Model | Rated voltage | Item | Resistive load |
|-------|---------------|------|----------------|
| V-21  | AC250V        |      | 21 A           |
|       | DC125V        |      | 0.6 A          |
|       | DC250V        |      | 0.3 A          |
| V-16  | AC250V        |      | 16 A           |
|       | DC125V        |      | 0.6 A          |
|       | DC250V        |      | 0.3 A          |
| V-15  | AC250V        |      | 15 A           |
|       | DC125V        |      | 0.6 A          |
|       | DC250V        |      | 0.3 A          |
| V-10  | AC250V        |      | 10 A           |
|       | DC125V        |      | 0.6 A          |
|       | DC250V        |      | 0.3 A          |

Note. The above rating values apply under the following test conditions.

- (1) Ambient temperature: 20±2°C
- (2) Ambient humidity: 65±5% RH
- (3) Operating frequency: 30 operations/min

## Characteristics

| Item  | Model   | V-10   | V-15   | V-16  | V-21        |
|---|---|--|--|---|-------------|
| Permissible operating speed                 |   | 0.1mm to 1 m/s max. (pin plunger models)   |  |   |             |
| Permissible operating frequency             | Mechanical  | 600 operations/min max. (pin plunger models)   |  |   |             |
|   | Electrical  | 60 operations/min  |  |   |             |
| Insulation resistance                       |   | 100MΩ min. (at 500 VDC with insulation tester)   |  |   |             |
| Contact resistance (initial value)          |   | 15mΩ max.  |  |   |             |
| Dielectric strength *1                      | Between terminals of the same polarity                      | AC1,000V 50/60Hz 1min  |  |   |             |
|   | Between current-carrying metal parts and ground             | AC1,500V 50/60Hz 1min  | AC1,500V 50/60Hz 1min  | AC2,000V 50/60Hz 1min                       |             |
|   | Between each terminals and non-current-carrying metal parts | AC1,500V 50/60Hz 1min  | AC1,500V 50/60Hz 1min  | AC2,000V 50/60Hz 1min                       |             |
| Vibration resistance *2                     | Malfunction   | 10 to 55 Hz, 1.5-mm double amplitude   |  |   |             |
| Shock resistance *2                         | Durability  | 1,000 m/s <sup>2</sup> {approx. 100 G} max.  |  |   |             |
|   | Malfunction   | 200 m/s <sup>2</sup> {approx. 20G} max.  | 300 m/s <sup>2</sup> {approx. 30 G} max.   |   |             |
| Durability *3                               | Mechanical  | 50,000,000 operations min. (60 operations/min)   |  |   |             |
|   | Electrical  | 300,000 operations min. (30 operations/min)<br>Heat resistive: 50,000 operations min (30 operations/min) | 100,000 operations min. (30 operations/min)<br>Heat resistive: 20,000 operations min (30 operations/min) | 100,000 operations min. (30 operations/min) |             |
| Degree of protection                        |   | IEC IP40   |  |   |             |
| Degree of protection against electric shock |   | Class I  |  |   |             |
| Proof tracking index (PTI)                  |   | 175  |  |   |             |
| Ambient operating temperature               |   | -25 to 105°C (Heat resistive: -25 to 150°C)  |  | -25 to 105°C                                | -25 to 80°C |
| Ambient operating humidity                  |   | (at ambient humidity of 60% max.) (with no icing or condensation)<br>85% max. (for 5 to 35°C)            |  |   |             |
| Weight                                      |   | Approx. 6.2g (pin plunger models)  |  |   |             |

Note. The data given above are initial values.

- \*1. The dielectric strength shown in the table indicates a value for models with a Separator.
- \*2. For the pin plunger models, the above values apply for use at the free position and total travel position. For the lever models, they apply at the total travel position. Close or open circuit of the contact is shorter than 1 ms.
- \*3. For testing conditions, consult your OMRON sales representative.

## Approved Standards

### UL (UL1054)/CSA (CSA C22.2 No.55)

| Rated voltage      | Model | V-21         | V-16      | V-15      | V-10      |
|--------------------|-------|--------------|-----------|-----------|-----------|
| 125 VAC<br>250 VAC |       | 21A 1/2HP    | 16A 1/2HP | 15A 1/2HP | 10A 1/2HP |
| 125 VDC<br>250 VDC |       | 0.6A<br>0.3A |           |           |           |

### VDE (EN61058-1)

Consult your OMRON sales representative for specific models with VDE approvals.

| Rated voltage | Model | V-21   | V-16   |
|---------------|-------|--------|--------|
| AC250V        |       | 20(4)A | 16(4)A |

Testing conditions: 5E4 (50,000 operations), for models of V-21: T80 (0 to 80°C), for models of V-16: T105 (0 to 105°C)

**Terminals and Appearance (Unit: mm)**

| Solder terminals (A)  | Quick-connect terminals (#187) (C2)                         | Quick-connect terminals (#250) (C)                            |
|---|---|---|
| <p>t=0.5 (10)<br/>Three, solder terminals</p>                     | <p>t=0.5 (10)<br/>Three, quick-connect terminals (#187)</p> | <p>t=0.8 (12.0)<br/>Three, quick-connect terminals (#250)</p> |
| <p>* Indicates the length to the center of the 1.6-dia. holes</p> | <p>1.6-dia. terminal hole</p>                               | <p>1.65-dia. terminal hole</p>                                |

Note. The above is for the SPDT contact specifications. Two terminals will be available for SPST-NO or SPST-NC contact specifications. For terminal positions, refer to Contact form on page 9.

**Mounting Holes (Unit: mm)**

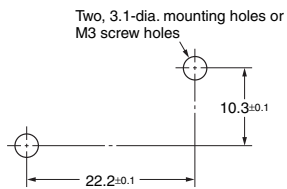

## Dimensions and Operating Characteristics

### Thermoplastic Case V-21/-16 Models

The following illustrations and drawings are for quick-connect terminals #250 (terminals C). V models with a switching current of 16 A and 11 A incorporate solder terminals (A) and quick-connect terminals #187 (C2). These models are different from #250 models in terminal size only. Dimensions of solder terminals (A) and quick-connect terminal #187 (C2) are omitted. Please refer to the "Terminals and Shapes" on previous page.

The □ is replaced with the code for the terminals. See the "List of Models" for available combinations of shapes.

#### ●Pin plunger

V-21-1□6

V-16-1□6

V-16-1□5

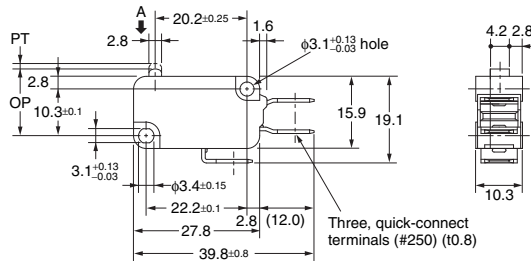
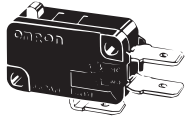

| Operating characteristics | Model | V-21-1□6<br>V-16-1□6 | V-16-1□5 |
|---------------------------|-------|----------------------|----------|
| OF max.                   |       | 3.92N                | 1.96N    |
| RF min.                   |       | 0.78N                | 0.49N    |
| PT max.                   |       | 1.2mm                |          |
| OT min.                   |       | 1.0mm                |          |
| MD max.                   |       | 0.4mm                |          |
| OP                        |       | 14.7±0.4mm           |          |

#### ●Short hinge lever

V-211-1□6

V-161-1□6

V-161-1□5

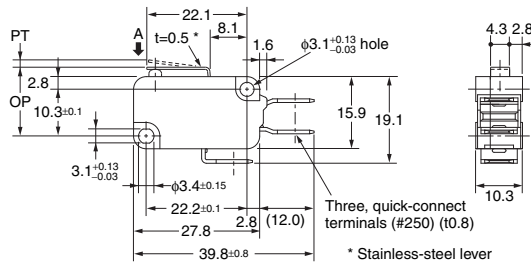
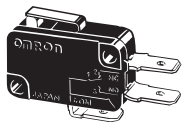

| Operating characteristics | Model | V-211-1□6<br>V-161-1□6 | V-161-1□5 |
|---------------------------|-------|------------------------|-----------|
| OF max.                   |       | 3.92N                  | 1.96N     |
| RF min.                   |       | 0.49N                  | 0.49N     |
| PT max.                   |       | 1.6mm                  |           |
| OT min.                   |       | 0.8mm                  |           |
| MD max.                   |       | 0.6mm                  |           |
| OP                        |       | 15.2±0.5mm             |           |

#### ●Hinge lever

V-212-1□6

V-162-1□6

V-162-1□5

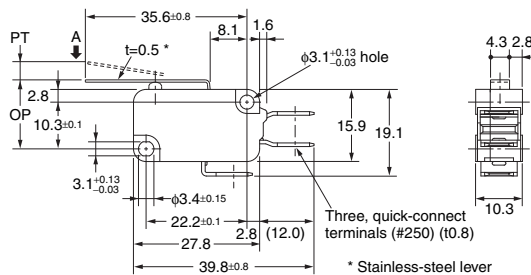
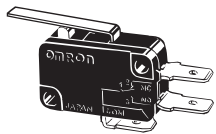

| Operating characteristics | Model | V-212-1□6<br>V-162-1□6 | V-162-1□5 |
|---------------------------|-------|------------------------|-----------|
| OF max.                   |       | 2.45N                  | 1.23N     |
| RF min.                   |       | 0.25N                  | 0.14N     |
| PT max.                   |       | 4.0mm                  |           |
| OT min.                   |       | 1.6mm                  |           |
| MD max.                   |       | 1.5mm                  |           |
| OP                        |       | 15.2±1.2mm             |           |

#### ●Long Hinge Lever Models

V-213-1□6

V-163-1□6

V-163-1□5

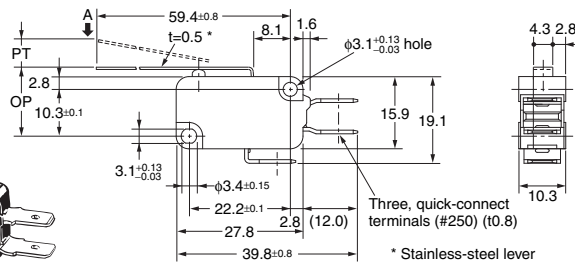
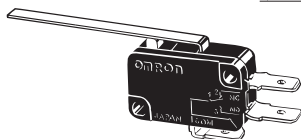

| Operating characteristics | Model | V-213-1□6<br>V-163-1□6                    | V-163-1□5 |
|---------------------------|-------|---|-----------|
| OF max.                   |       | 1.27N                                     | 0.69N     |
| RF min.                   |       | 0.12N                                     | 0.06N     |
| PT max.                   |       | 9.0mm                                     |           |
| OT min.                   |       | 2.0mm                                     |           |
| MD max.                   |       | 2.8mm                                     |           |
| OP                        |       | 15.2 <sup>+2.6</sup> / <sub>-3.2</sub> mm |           |

Note 1. Unless otherwise specified, a tolerance of ±0.4 mm applies to all dimensions.

Note 2. The operating characteristics are for operation in the A direction (↓).

● Simulated roller lever

V-214-1□6  
V-164-1□6  
V-164-1□5

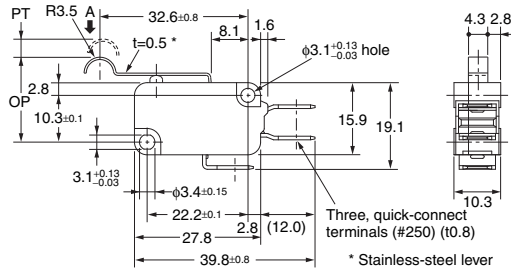
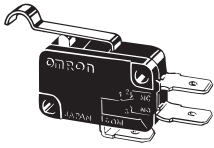

| Operating characteristics | Model | V-214-1□6<br>V-164-1□6 | V-164-1□5 |
|---------------------------|-------|------------------------|-----------|
| OF max.                   |       | 2.45N                  | 1.23N     |
| RF min.                   |       | 0.25N                  | 0.14N     |
| PT max.                   |       | 4.0mm                  |           |
| OT min.                   |       | 1.6mm                  |           |
| MD max.                   |       | 1.5mm                  |           |
| OP                        |       | 18.7±1.2mm             |           |

● Short hinge roller lever

V-215-1□6  
V-165-1□6  
V-165-1□5

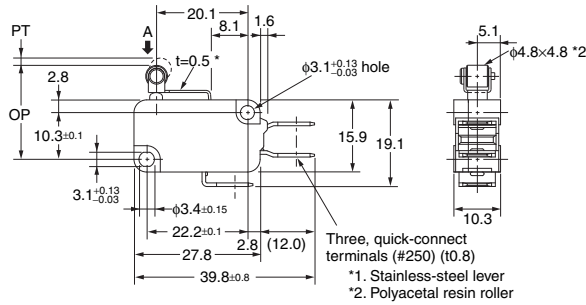
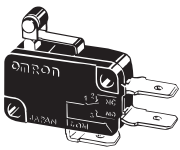

| Operating characteristics | Model | V-215-1□6<br>V-165-1□6 | V-165-1□5 |
|---------------------------|-------|------------------------|-----------|
| OF max.                   |       | 4.71N                  | 2.35N     |
| RF min.                   |       | 0.49N                  | 0.49N     |
| PT max.                   |       | 1.6mm                  |           |
| OT min.                   |       | 0.8mm                  |           |
| MD max.                   |       | 0.6mm                  |           |
| OP                        |       | 20.7±0.6mm             |           |

● Hinge roller lever

V-216-1□6  
V-166-1□6  
V-166-1□5

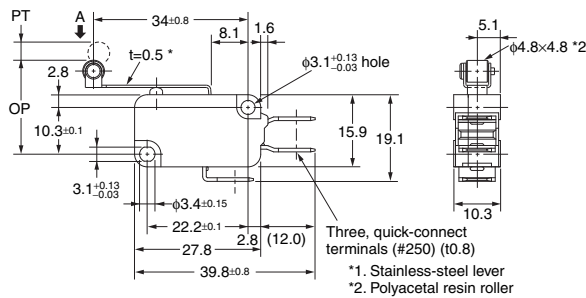
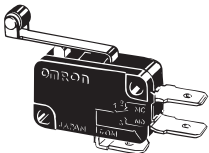

| Operating characteristics | Model | V-216-1□6<br>V-166-1□6 | V-166-1□5 |
|---------------------------|-------|------------------------|-----------|
| OF max.                   |       | 2.45N                  | 1.23N     |
| RF min.                   |       | 0.25N                  | 0.14N     |
| PT max.                   |       | 4.0mm                  |           |
| OT min.                   |       | 1.6mm                  |           |
| MD max.                   |       | 1.5mm                  |           |
| OP                        |       | 20.7±1.2mm             |           |

Note 1. Unless otherwise specified, a tolerance of ±0.4 mm applies to all dimensions.  
Note 2. The operating characteristics are for operation in the A direction (↓).

## Thermosetting Case (V-15/V-10 Models) Applicable to both Standard (105°C) and Heat-resistant (150°C) models

The following dimensions and Operating Characteristics are for both "Not specified: Standard (105°C)" and "-T: Heat-resistant (150°C)" models. The following illustrations and drawings are for solder terminals (Terminal A). V models with a switching current of 15A and 10A have quick-connect terminals #187 (C2). These models are different from solder terminal models in terminal size only. Illustrations for quick-connect terminals #187 (C2) are omitted. Please refer to "Terminals and Shapes" on page 8.

The □ is replaced with the code for the terminals. See the "List of Models" for available combinations of shapes.

### ●Pin plunger

- V-15-1□6
- V-15-1□5
- V-10-1□5
- V-10-1□4

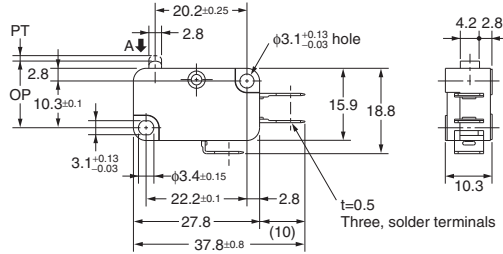
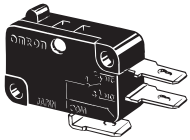

| Operating characteristics | Model | V-15-1□6   | V-15-1□5<br>V-10-1□5 | V-10-1□4 |
|---------------------------|-------|------------|----------------------|----------|
| OF max.                   |       | 3.92N      | 1.96N                | 0.98N    |
| RF min.                   |       | 078N       | 0.49N                | 0.20N    |
| PT max.                   |       | 1.2mm      |                      |          |
| OT min.                   |       | 1.0mm      |                      |          |
| MD max.                   |       | 0.4mm      |                      |          |
| OP                        |       | 14.7±0.4mm |                      |          |

### ●Short hinge lever

- V-151-1□6
- V-151-1□5
- V-101-1□5
- V-101-1□4

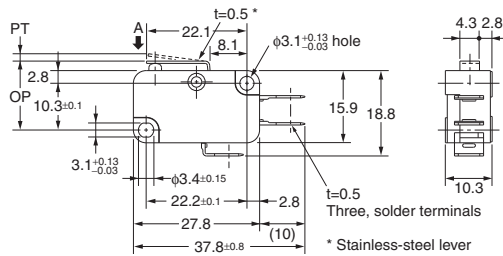
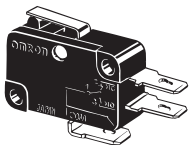

| Operating characteristics | Model | V-151-1□6  | V-151-1□5<br>V-101-1□5 | V-101-1□4 |
|---------------------------|-------|------------|------------------------|-----------|
| OF max.                   |       | 3.92N      | 1.96N                  | 0.98N     |
| RF min.                   |       | 0.49N      | 0.49N                  | 0.15N     |
| PT max.                   |       | 1.6mm      |                        |           |
| OT min.                   |       | 0.8mm      |                        |           |
| MD max.                   |       | 0.6mm      |                        |           |
| OP                        |       | 15.2±0.5mm |                        |           |

### ●Hinge lever

- V-152-1□6
- V-152-1□5
- V-102-1□5
- V-102-1□4

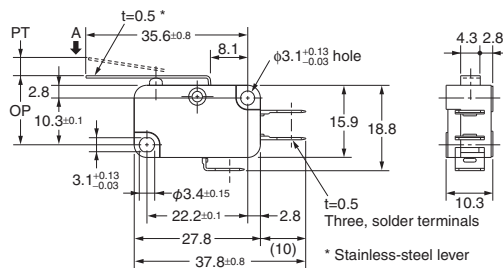
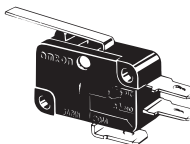

| Operating characteristics | Model | V-152-1□6  | V-152-1□5<br>V-102-1□5 | V-102-1□4 |
|---------------------------|-------|------------|------------------------|-----------|
| OF max.                   |       | 2.45N      | 1.23N                  | 0.59N     |
| RF min.                   |       | 0.25N      | 0.14N                  | 0.06N     |
| PT max.                   |       | 4.0mm      |                        |           |
| OT min.                   |       | 1.6mm      |                        |           |
| MD max.                   |       | 1.5mm      |                        |           |
| OP                        |       | 15.2±1.2mm |                        |           |

### ●Long Hinge Lever Models

- V-153-1□6
- V-153-1□5
- V-103-1□5
- V-103-1□4

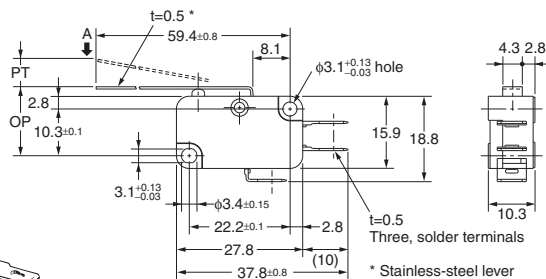
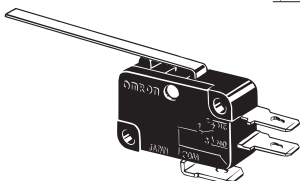

| Operating characteristics | Model | V-153-1□6                                 | V-153-1□5<br>V-103-1□5 | V-103-1□4   |
|---------------------------|-------|---|------------------------|-------------|
| OF max.                   |       | 1.27N                                     | 0.69N                  | 0.34N       |
| RF min.                   |       | 0.12N                                     | 0.06N                  | -           |
| PT max.                   |       | 9.0mm                                     |                        |             |
| OT min.                   |       | 2.0mm                                     |                        |             |
| MD max.                   |       | 2.8mm                                     |                        |             |
| OP                        |       | 15.2 <sup>+2.6</sup> / <sub>-3.2</sub> mm |                        | 15.2±2.6 mm |

Note 1. Unless otherwise specified, a tolerance of ±0.4 mm applies to all dimensions.  
 Note 2. The operating characteristics are for operation in the A direction (↓).

● Simulated roller lever

- V-154-1□6
- V-154-1□5
- V-104-1□5
- V-104-1□4

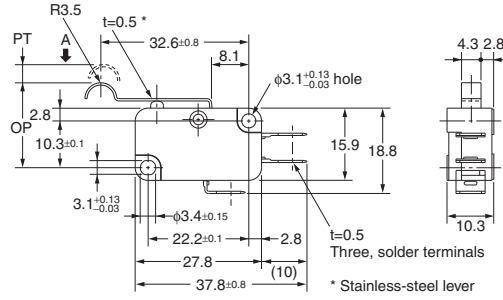
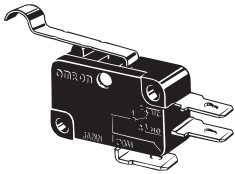

| Operating characteristics | Model | V-154-1□6  | V-154-1□5<br>V-104-1□5 | V-104-1□4 |
|---------------------------|-------|------------|------------------------|-----------|
| OF max.                   |       | 2.45N      | 1.23N                  | 0.59N     |
| RF min.                   |       | 0.25N      | 0.14N                  | 0.06N     |
| PT max.                   |       | 4.0mm      |                        |           |
| OT min.                   |       | 1.6mm      |                        |           |
| MD max.                   |       | 1.5mm      |                        |           |
| OP                        |       | 18.7±1.2mm |                        |           |

● Short hinge roller lever

- V-155-1□6
- V-155-1□5
- V-105-1□5
- V-105-1□4

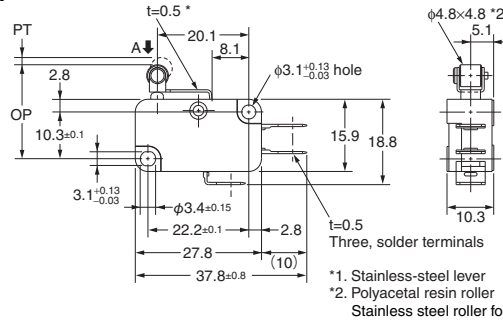
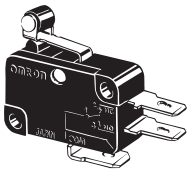

| Operating characteristics | Model | V-155-1□6  | V-155-1□5<br>V-105-1□5 | V-105-1□4 |
|---------------------------|-------|------------|------------------------|-----------|
| OF max.                   |       | 4.71N      | 2.35N                  | 1.18N     |
| RF min.                   |       | 0.49N      | 0.49N                  | 0.15N     |
| PT max.                   |       | 1.6mm      |                        |           |
| OT min.                   |       | 0.8mm      |                        |           |
| MD max.                   |       | 0.6mm      |                        |           |
| OP                        |       | 20.7±0.6mm |                        |           |

● Hinge roller lever

- V-156-1□6
- V-156-1□5
- V-106-1□5
- V-106-1□4

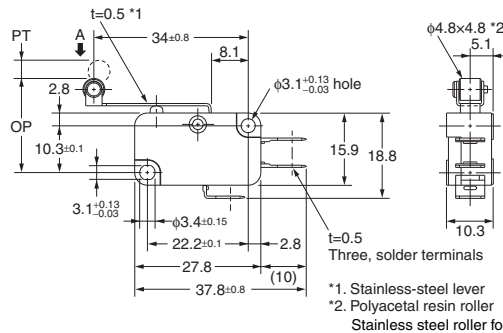
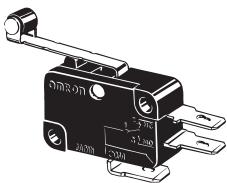

| Operating characteristics | Model | V-156-1□6  | V-156-1□5<br>V-106-1□5 | V-106-1□4 |
|---------------------------|-------|------------|------------------------|-----------|
| OF max.                   |       | 2.45N      | 1.23N                  | 0.59N     |
| RF min.                   |       | 0.25N      | 0.14N                  | 0.06N     |
| PT max.                   |       | 4.0mm      |                        |           |
| OT min.                   |       | 1.6mm      |                        |           |
| MD max.                   |       | 1.5mm      |                        |           |
| OP                        |       | 20.7±1.2mm |                        |           |

Note 1. Unless otherwise specified, a tolerance of ±0.4 mm applies to all dimensions.  
 Note 2. The operating characteristics are for operation in the A direction (↓).

Precautions

★ Please read "Common Precautions" for correct use.

Precautions for Safe Use

● Soldering

- Connecting to Solder Terminals  
 Complete the soldering at the iron tip temperature of 250 to 350°C (60W) within 5 seconds, and do not apply any external force for 1 minute after soldering.  
 Be sure to apply only the minimum required amount of flux. It may result in contact failure once the flux penetrates into the internal part of the Switch.
- Connecting to Quick-connect Terminals #187  
 Insert the receptacle of quick-connect terminal #187 straight toward the terminal.  
 Applying excessive external force horizontally or vertically may cause deformation of terminals and may damage the housings.
- Connecting to Quick-connect Terminals #250  
 Insert the receptacle of quick-connect terminal #250 straight toward the terminal.  
 Applying excessive external force horizontally or vertically may cause deformation of terminals and may damage the housings.

Precautions for Correct Use

● Mounting

Use M3 mounting screw with plane washers or spring washers to securely mount the Switch. Tighten the screws to a torque of 0.39 to 0.59N·m {4 to 6 kgf·cm}.

- Application examples provided in this document are for reference only. In actual applications, confirm equipment functions and safety before using the product.
- Consult your OMRON representative before using the product under conditions which are not described in the manual or applying the product to nuclear control systems, railroad systems, aviation systems, vehicles, combustion systems, medical equipment, amusement machines, safety equipment, and other systems or equipment that may have a serious influence on lives and property if used improperly. Make sure that the ratings and performance characteristics of the product provide a margin of safety for the system or equipment, and be sure to provide the system or equipment with double safety mechanisms.

**Note: Do not use this document to operate the Unit.**