

Dimension:

Pos	Dim.A	Dim.B	Pos	Dim.A	Dim.B
02	—	5.4	14	25.2	30.6
04	4.2	9.6	16	29.4	34.8
06	8.4	13.8	18	33.6	39.0
08	12.6	18.0	20	37.8	43.2
10	16.8	22.2	22	42.0	47.4
12	21.0	26.4	24	46.2	51.6

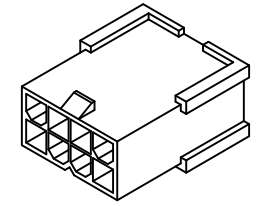

Specifications:

Current Rating: 4.5~12A AC/DC
 Voltage Rating: 600V AC/DC
 Contact Resistance: 10m Ohm. Max.
 Insulation Resistance: 1000M Ohm. Min.
 Withstanding Voltage: 1500V AC/Minute
 Operating Temperature Range: -40°C To +105°C

Material:

Insulator: Nylon 66 (UL94V-0)
 Insulator Color: White

MAXIMUM CURRENT RATING:

WIRE SIZE	WIRE-TO-WIRE					
	Dual Row Circuit Sizes					
	2	4	6,8	10,12	14,16,18	20,22,24
16 AWG	12A	11A	10A	9.5A	9A	8.5A
18 AWG	10A	9A	8A	7.5A	7A	6.5A
20 AWG	8.5A	7.5A	7A	6.5A	6A	5.5A

WIRE SIZE	WIRE-TO-BOARD					
	Dual Row Circuit Sizes					
	2	4	6,8	10,12	14,16,18	20,22,24
16 AWG	11.5A	10.5A	9A	8A	7.5A	7A
18 AWG	9.5A	8.5A	7.5A	7A	6.5A	6A
20 AWG	8A	7A	6A	5.5A	5A	4.5A

RoHS Compliant

				DRAWN: Cherry	GENERAL TOLERANCE: .X=±0.40 .XX=±0.30	<h1 style="color: red; text-align: center;">CnC Tech</h1> <p style="text-align: center;">Industrial Cable and Connector Technology</p>	
				CHECKED: Dennis Lin			
B	04-DEC-2023		Zongyi	APPROVAL: Mike Wu	SCALE: 1:1	PART NO: 4282-3-XX-D	SIZE A4
A	10-Jan-2020		Andrew		SHEET: 1 / 3		
REV	DATE	FILE	BY		PROJECTION:		

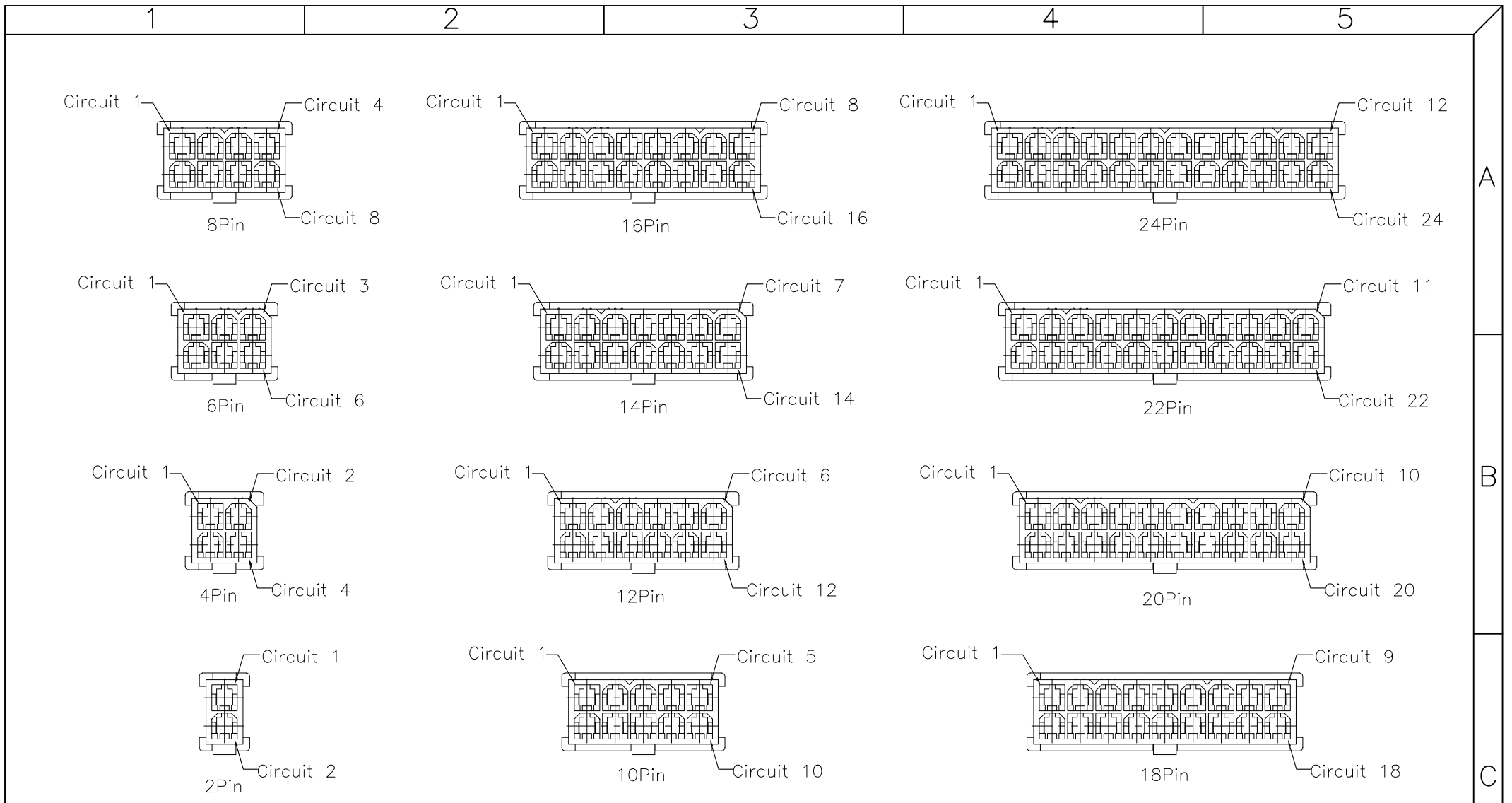

2~24P Protection Key Drawing(Ref.)

RoHS Compliant

				DRAWN: Cherry	GENERAL TOLERANCE: .X=±0.40 .XX=±0.30	<h1 style="color: red; text-align: center;">CnC Tech</h1> <p style="text-align: center;">Industrial Cable and Connector Technology</p>	
				CHECKED: Dennis Lin	UNIT: MM SCALE:1:1		
B	04-DEC-2023		Zongyi	APPROVAL: Mike Wu	SHEET: 2 / 3	PART NO: 4282-3-XX-D	D
A	10-Jan-2020		Andrew		PROJECTION:		
REV	DATE	FILE	BY				

1

2

3

4

5

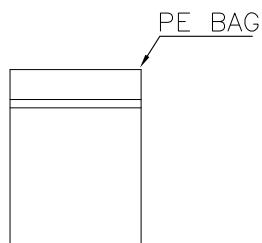
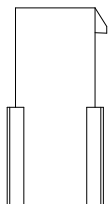
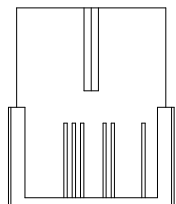
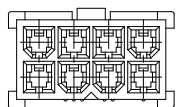

Note:

1.Dimension:

Pe Bag Size:XX*XX (mm)

Carton Size:400*280*280(mm)

Pin.	Pcs/Bag	Pcs/Carton	Pin.	Pcs/Bag	Pcs/Carton
2	200	5600	14	100	1600
4	200	4600	16	100	1200
6	100	3000	18	100	1000
8	100	2400	20	100	1000
10	100	2000	22	50	800
12	100	1800	24	50	800

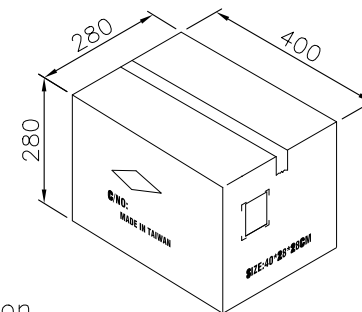
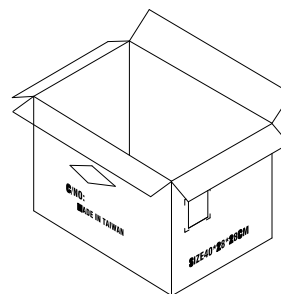

Carton

				DRAWN: Cherry	GENERAL TOLERANCE: .X=±0.2 .XX=±0.15	CnC Tech Industrial Cable and Connector Technology	
				CHECKED: Dennis Lin	UNIT: MM		DESCRIPTION: CONN PLUG DUAL 94V-0 PACKING
B	04-DEC-2023		Zongyi	APPROVAL: Mike Wu	SCALE:	PART NO: 4282-3-XX-D	
A	10-Jan-2020		Andrew		SHEET: 3 / 3		
REV	DATE	FILE	BY		PROJECTION:		