

# CSTCR4M00G55-R0

In Production RoHS REACH

## Appearance & Shape

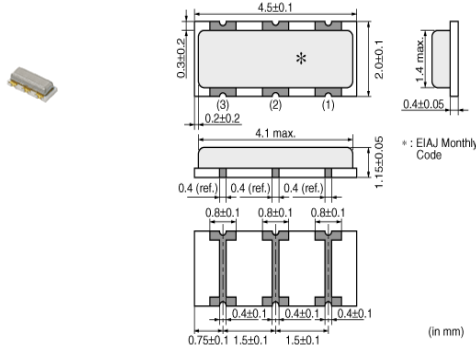

## Features

MURATA's package technology expertise has enabled the development of the Chip "CERALOCK" with built-in load capacitors. High-density mounting can be realized because of the small package and the elimination of the need for an external load capacitor.

### Features

1. Oscillation circuits do not require external load capacitors.
2. The series is available in a wide frequency range.
3. The resonators are extremely small and have a low profile.
4. No adjustment is necessary for oscillation circuits.

## Applications

Other Usage	Consumer/Industrial
-------------	---------------------

## Packaging Information

Packaging	Specifications	Minimum Order Quantity
-R0	180mm Embossed Tape	3000

### Attention

1. This datasheet is downloaded from the website of Murata Manufacturing Co., Ltd. Therefore, its specifications are subject to change or our products may be discontinued without advance notice. Please check with our sales representatives or product engineers before ordering.  
 2. This datasheet has only typical specifications because there is no space for detailed specifications.  
 Therefore, please review our product specifications or consult the approval sheet for product specifications before ordering.

# CSTCR4M00G55-R0

## Specifications

Shape	SMD
Frequency	4.000MHz
Frequency Tolerance	±0.5%
Operating Temperature Range	-20°C to 80°C
Frequency Shift by Temperature	±0.2%
Frequency Aging	±0.1%
Wash	Not available
Resonant Impedance	60Ω
Built-in Load Capacitance	39pF

### Attention

1.This datasheet is downloaded from the website of Murata Manufacturing Co., Ltd. Therefore, it's specifications are subject to change or our products may be discontinued without advance notice. Please check with our sales representatives or product engineers before ordering.  
2.This datasheet has only typical specifications because there is no space for detailed specifications.  
Therefore, please review our product specifications or consult the approval sheet for product specifications before ordering.

# CSTCR4M00G55-R0

## Product Data

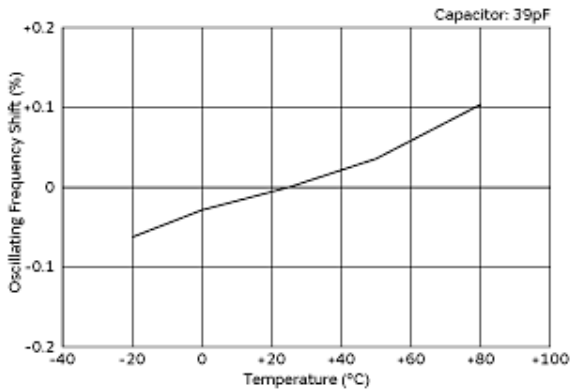

Temperature Characteristics

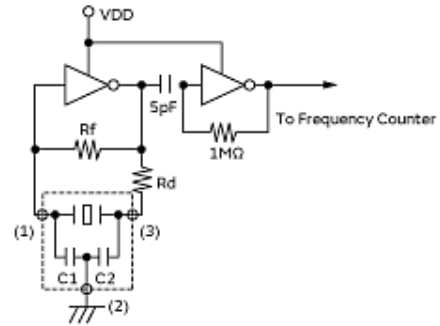

Regarding CERALOCK<sup>®</sup> with built-in capacitors, the terminal (1) and (3) are interchangeable, but if connection is interchanged, the specification of initial tolerance frequency may not be guaranteed.  
\*Please see dimensions about terminal numbers.

Measurement Circuit

**Attention**

1. This datasheet is downloaded from the website of Murata Manufacturing Co., Ltd. Therefore, its specifications are subject to change or our products may be discontinued without advance notice. Please check with our sales representatives or product engineers before ordering.  
2. This datasheet has only typical specifications because there is no space for detailed specifications.  
Therefore, please review our product specifications or consult the approval sheet for product specifications before ordering.