

CSD13381F4 12 V N-Channel FemtoFET™ MOSFET

1 Features

- Low On-Resistance
- Low Q_g and Q_{gd}
- Low Threshold Voltage
- Ultra-Small Footprint (0402 Case Size)
 - 1.0 mm x 0.6 mm
- Ultra-Low Profile
 - 0.35 mm Height
- Integrated ESD Protection Diode
 - Rated >4 kV HBM
 - Rated >2 kV CDM
- Lead and Halogen Free
- RoHS Compliant

2 Applications

- Optimized for Load Switch Applications
- Optimized for General Purpose Switching Applications
- Single-Cell Battery Applications
- Handheld and Mobile Applications

3 Description

This 140 m Ω , 12 V N-channel FemtoFET™ MOSFET technology is designed and optimized to minimize the footprint in many handheld and mobile applications. This technology is capable of replacing standard small signal MOSFETs while providing at least a 60% reduction in footprint size.

Typical Part Dimensions

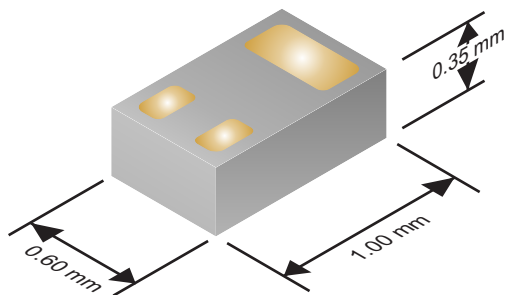

Product Summary

$T_A = 25^\circ\text{C}$		TYPICAL VALUE		UNIT
V_{DS}	Drain-to-Source Voltage	12		V
Q_g	Gate Charge Total (4.5 V)	1060		pC
Q_{gd}	Gate Charge Gate-to-Drain	140		pC
$R_{DS(on)}$	Drain-to-Source On-Resistance	$V_{GS} = 1.8\text{ V}$	310	m Ω
		$V_{GS} = 2.5\text{ V}$	170	m Ω
		$V_{GS} = 4.5\text{ V}$	140	m Ω
$V_{GS(th)}$	Threshold Voltage	0.85		V

Ordering Information⁽¹⁾

Device	Qty	Media	Package	Ship
CSD13381F4	3000	7-Inch Reel	Femto (0402) 1.0 mm x 0.6 mm SMD Lead Less	Tape and Reel
CSD13381F4T	250			

(1) For all available packages, see the orderable addendum at the end of the data sheet.

Absolute Maximum Ratings

$T_A = 25^\circ\text{C}$ unless otherwise stated		VALUE	UNIT
V_{DS}	Drain-to-Source Voltage	12	V
V_{GS}	Gate-to-Source Voltage	8	V
I_D	Continuous Drain Current, $T_A = 25^\circ\text{C}^{(1)}$	2.1	A
I_{DM}	Pulsed Drain Current, $T_A = 25^\circ\text{C}^{(2)}$	7	A
I_G	Continuous Gate Clamp Current	35	mA
	Pulsed Gate Clamp Current ⁽²⁾	350	
P_D	Power Dissipation ⁽¹⁾	500	mW
ESD Rating	Human Body Model (HBM)	4	kV
	Charged Device Model (CDM)	2	kV
T_J, T_{stg}	Operating Junction and Storage Temperature Range	-55 to 150	$^\circ\text{C}$
E_{AS}	Avalanche Energy, single pulse $I_D = 7.4\text{ A}$, $L = 0.1\text{ mH}$, $R_G = 25\ \Omega$	2.7	mJ

(1) Typical $R_{\theta JA} = 90^\circ\text{C/W}$ on 1 inch² (6.45 cm²), 2 oz. (0.071 mm thick) Cu pad on a 0.06 inch (1.52 mm) thick FR4 PCB.

(2) Pulse duration $\leq 300\ \mu\text{s}$, duty cycle $\leq 2\%$

Top View

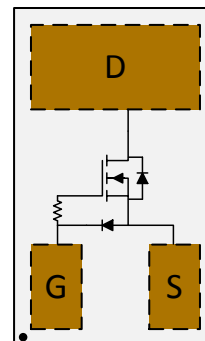

Table of Contents

1 Features	1	6.1 Trademarks	7
2 Applications	1	6.2 Electrostatic Discharge Caution	7
3 Description	1	6.3 Glossary	7
4 Revision History	2	7 Mechanical Data	8
5 Specifications	3	7.1 Mechanical Dimensions	8
5.1 Electrical Characteristics	3	7.2 Recommended Minimum PCB Layout	9
5.2 Thermal Information	3	7.3 Recommended Stencil Pattern	9
5.3 Typical MOSFET Characteristics	4	7.4 CSD13381F4 Embossed Carrier Tape Dimensions	10
6 Device and Documentation Support	7		

4 Revision History

NOTE: Page numbers for previous revisions may differ from page numbers in the current version.

Changes from Revision C (September 2014) to Revision D Page

- Corrected typo for I_{GSS} Test Condition

3

Changes from Revision B (February 2014) to Revision C Page

- Corrected timing V_{DS} to read 6 V

3

Changes from Revision A (November 2013) to Revision B Page

- Added I_G parameter
- Lowered I_{DSS} limit
- Lowered I_{GSS} limit

1

3

3

Changes from Original (July 2013) to Revision A Page

- Updated device ordering information
- Changed test voltage conditions
- Changed [Figure 4](#) Gate Charge graph

1

3

5

5 Specifications

5.1 Electrical Characteristics

($T_A = 25^\circ\text{C}$ unless otherwise stated)

PARAMETER		TEST CONDITIONS	MIN	TYP	MAX	UNIT
STATIC CHARACTERISTICS						
V_{DSS}	Drain-to-Source Voltage	$V_{GS} = 0\text{ V}, I_{DS} = 250\ \mu\text{A}$	12			V
I_{DSS}	Drain-to-Source Leakage Current	$V_{GS} = 0\text{ V}, V_{DS} = 9.6\text{ V}$			100	nA
I_{GSS}	Gate-to-Source Leakage Current	$V_{DS} = 0\text{ V}, V_{GS} = 8\text{ V}$			50	nA
$V_{GS(th)}$	Gate-to-Source Threshold Voltage	$V_{DS} = V_{GS}, I_{DS} = 250\ \mu\text{A}$	0.65	0.85	1.10	V
$R_{DS(on)}$	Drain-to-Source On-Resistance	$V_{GS} = 1.8\text{ V}, I_{DS} = 0.5\text{ A}$		310	400	m Ω
		$V_{GS} = 2.5\text{ V}, I_{DS} = 0.5\text{ A}$		170	225	m Ω
		$V_{GS} = 4.5\text{ V}, I_{DS} = 0.5\text{ A}$		140	180	m Ω
g_{fs}	Transconductance	$V_{DS} = 6\text{ V}, I_{DS} = 0.5\text{ A}$		3.2		S
DYNAMIC CHARACTERISTICS						
C_{iss}	Input Capacitance	$V_{GS} = 0\text{ V}, V_{DS} = 6\text{ V}, f = 1\text{ MHz}$		155	200	pF
C_{oss}	Output Capacitance			47	62	pF
C_{rss}	Reverse Transfer Capacitance			2.5	3.3	pF
R_G	Series Gate Resistance			23		Ω
Q_g	Gate Charge Total (4.5 V)	$V_{DS} = 6\text{ V}, I_{DS} = 0.5\text{ A}$		1060	1400	pC
Q_{gd}	Gate Charge Gate-to-Drain			140		pC
Q_{gs}	Gate Charge Gate-to-Source			230		pC
$Q_{g(th)}$	Gate Charge at V_{th}			155		pC
Q_{oss}	Output Charge	$V_{DS} = 6\text{ V}, V_{GS} = 0\text{ V}$		1120		pC
$t_{d(on)}$	Turn On Delay Time	$V_{DS} = 6\text{ V}, V_{GS} = 4.5\text{ V}, I_{DS} = 0.5\text{ A}, R_G = 2\ \Omega$		3.7		ns
t_r	Rise Time			1.5		ns
$t_{d(off)}$	Turn Off Delay Time			11.0		ns
t_f	Fall Time			3.8		ns
DIODE CHARACTERISTICS						
V_{SD}	Diode Forward Voltage	$I_{SD} = 0.5\text{ A}, V_{GS} = 0\text{ V}$		0.73	0.9	V
Q_{rr}	Reverse Recovery Charge	$V_{DS} = 6\text{ V}, I_F = 0.5\text{ A}, di/dt = 300\text{ A}/\mu\text{s}$		1550		pC
t_{rr}	Reverse Recovery Time			6		ns

5.2 Thermal Information

($T_A = 25^\circ\text{C}$ unless otherwise stated)

THERMAL METRIC		TYPICAL VALUES	UNIT
$R_{\theta JA}$	Junction-to-Ambient Thermal Resistance ⁽¹⁾	90	$^\circ\text{C}/\text{W}$
	Junction-to-Ambient Thermal Resistance ⁽²⁾	250	

(1) Device mounted on FR4 material with 1 inch² (6.45 cm²), 2 oz. (0.071 mm thick) Cu.

(2) Device mounted on FR4 material with minimum Cu mounting area.

5.3 Typical MOSFET Characteristics

($T_A = 25^\circ\text{C}$ unless otherwise stated)

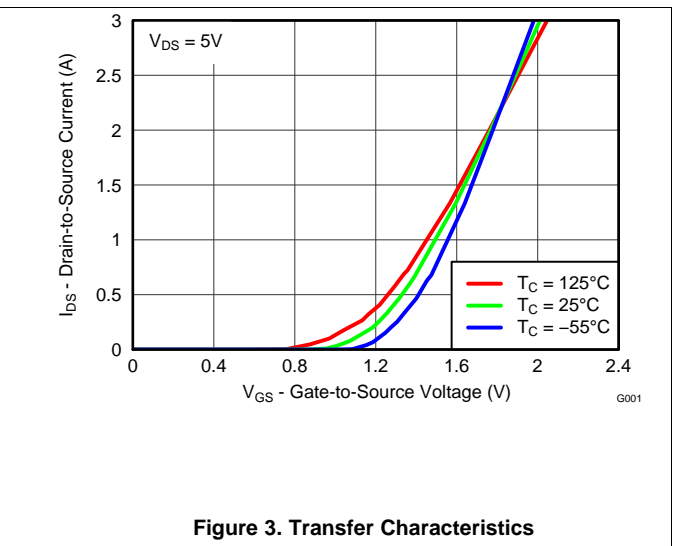
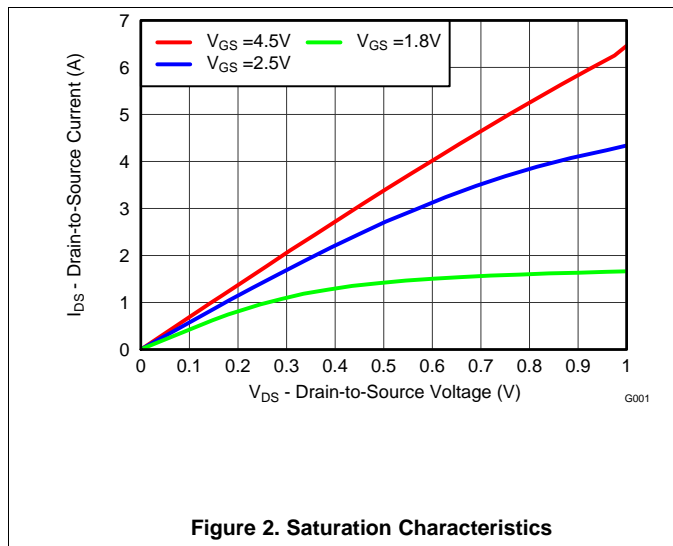
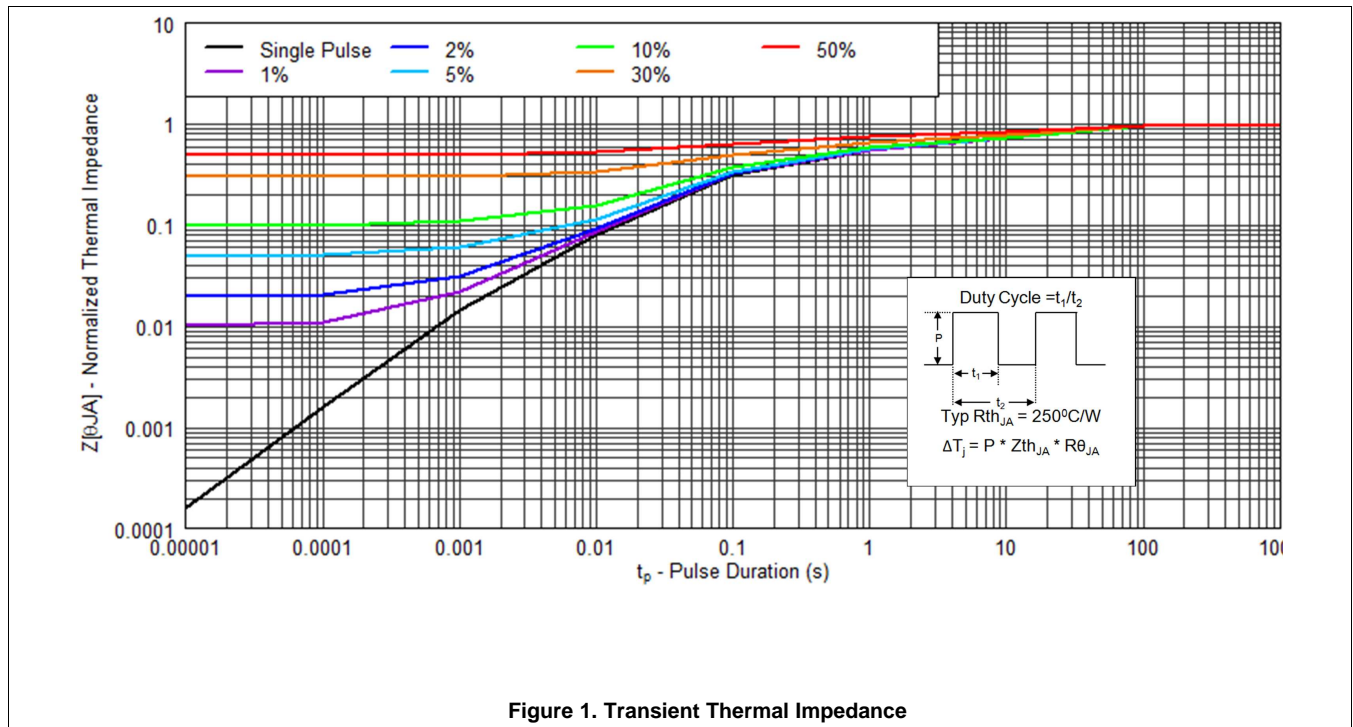

Typical MOSFET Characteristics (continued)

($T_A = 25^\circ\text{C}$ unless otherwise stated)

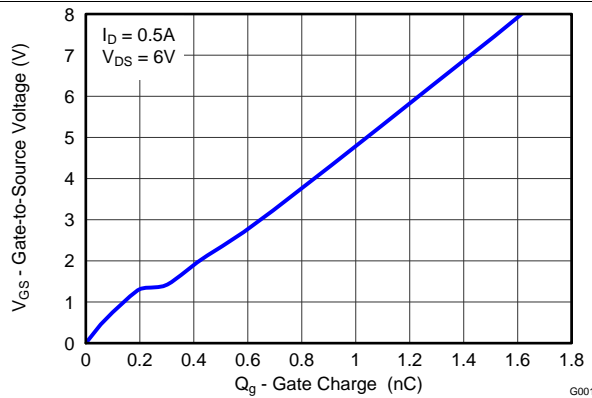

Figure 4. Gate Charge

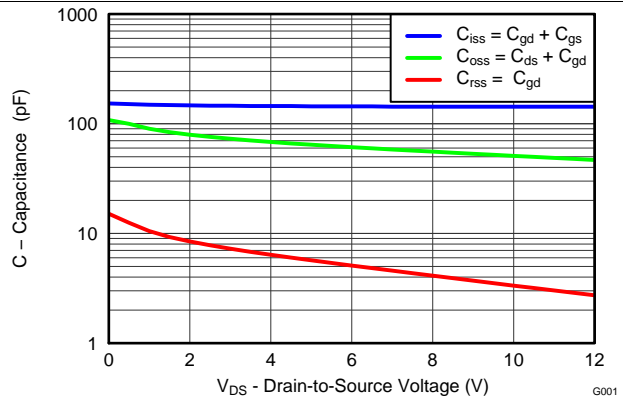

Figure 5. Capacitance

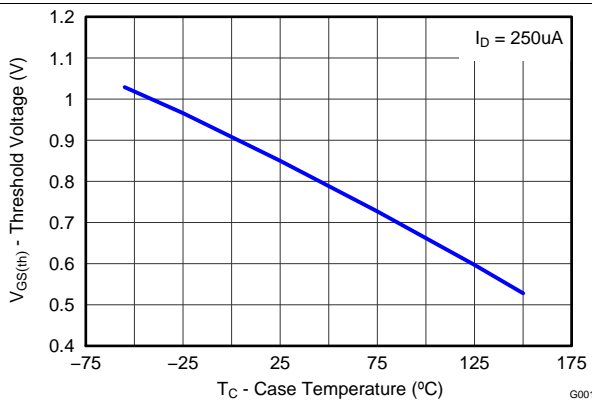

Figure 6. Threshold Voltage vs Temperature

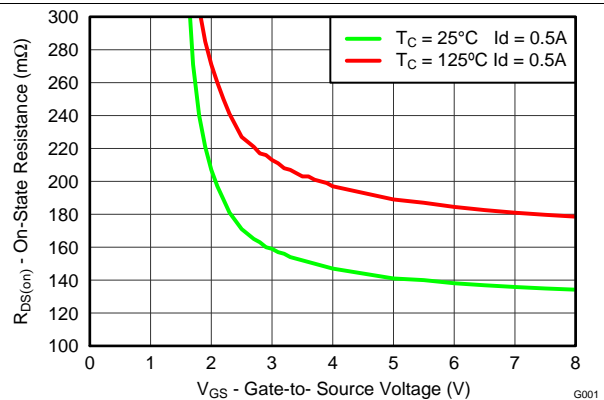

Figure 7. On-State Resistance vs Gate-to-Source Voltage

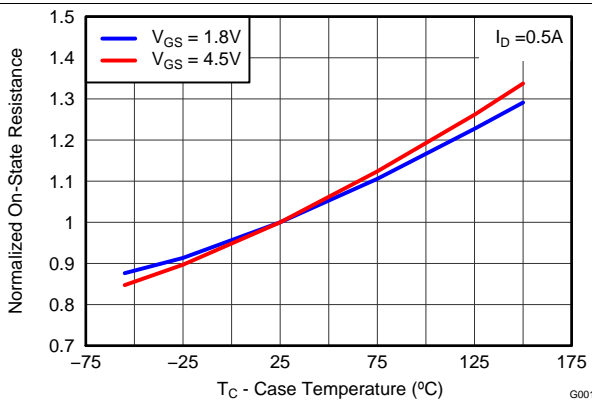

Figure 8. Normalized On-State Resistance vs Temperature

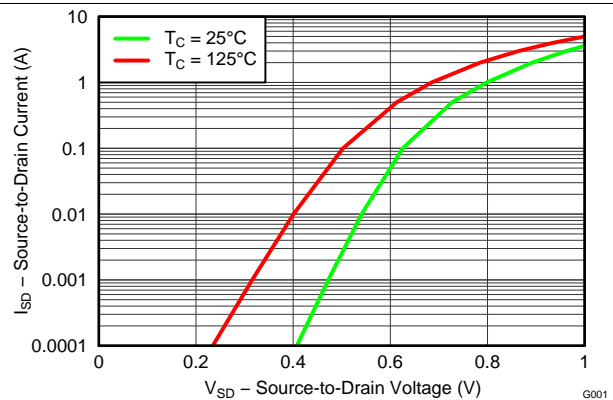
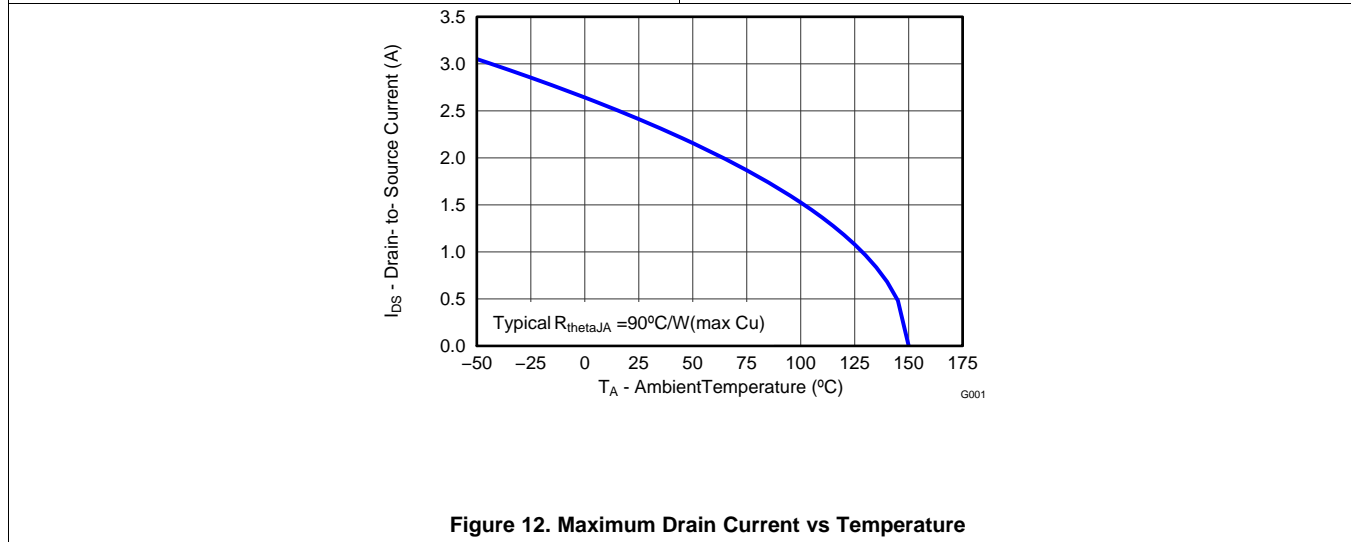
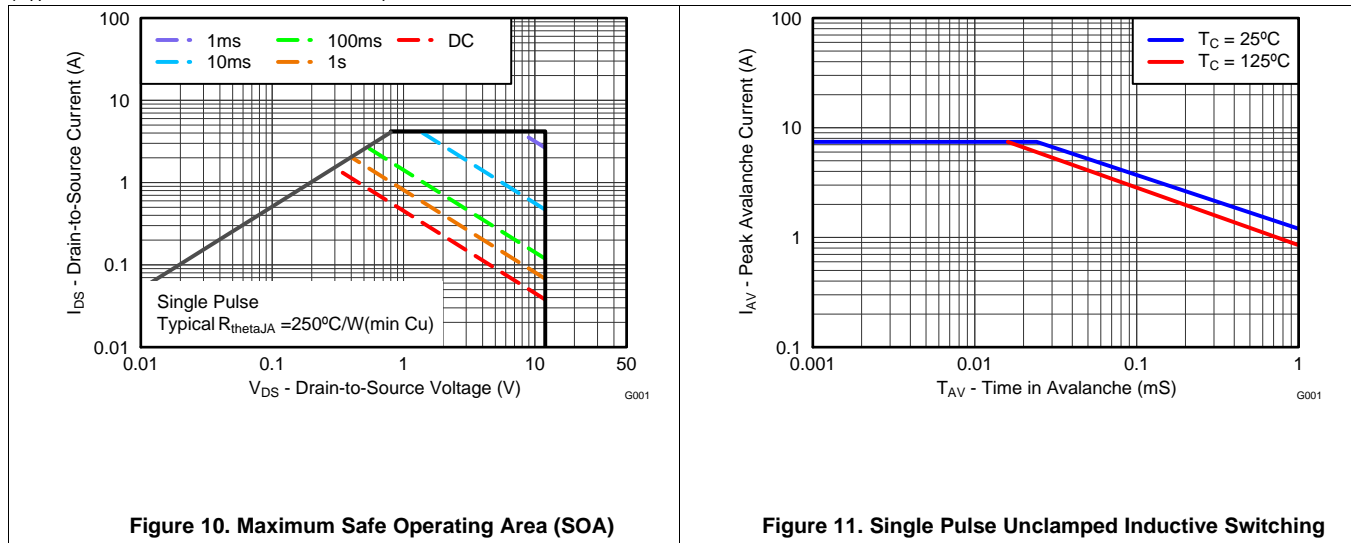

Figure 9. Typical Diode Forward Voltage

Typical MOSFET Characteristics (continued)

($T_A = 25^\circ\text{C}$ unless otherwise stated)



6 Device and Documentation Support

6.1 Trademarks

FemtoFET is a trademark of Texas Instruments.
All other trademarks are the property of their respective owners.

6.2 Electrostatic Discharge Caution



These devices have limited built-in ESD protection. The leads should be shorted together or the device placed in conductive foam during storage or handling to prevent electrostatic damage to the MOS gates.

6.3 Glossary

[SLYZ022](#) — *TI Glossary*.

This glossary lists and explains terms, acronyms, and definitions.

7 Mechanical Data

The following pages include mechanical, packaging, and orderable information. This information is the most current data available for the designated devices. This data is subject to change without notice and revision of this document. For browser-based versions of this data sheet, refer to the left-hand navigation.

7.1 Mechanical Dimensions

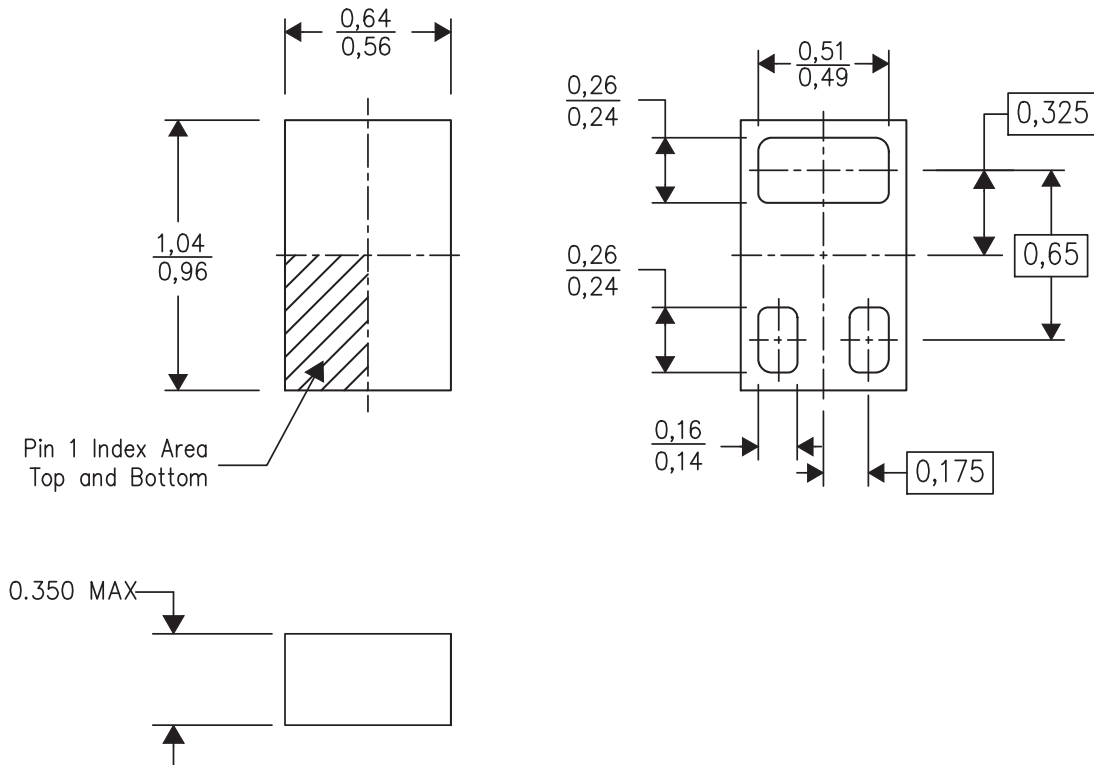

- (1) All linear dimensions are in millimeters (dimensions and tolerancing per AME T14.5M-1994).
- (2) This drawing is subject to change without notice.
- (3) This package is a PB-free solder land design.

7.2 Recommended Minimum PCB Layout

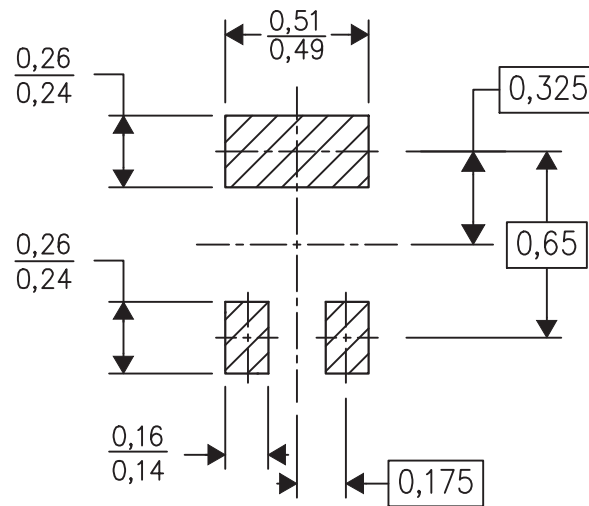

(1) All dimensions are in millimeters.

7.3 Recommended Stencil Pattern

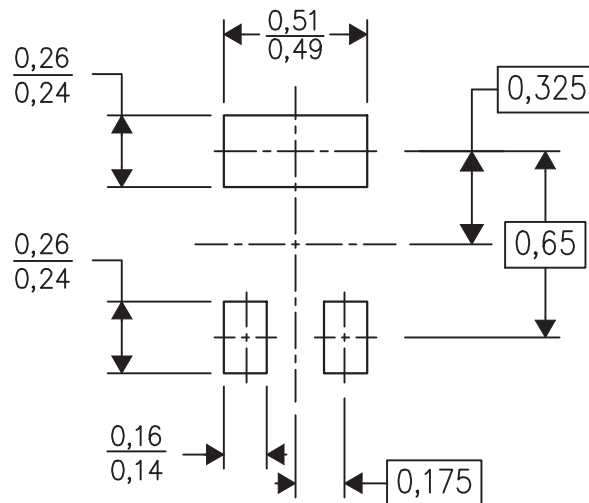

(1) All dimensions are in millimeters.

CSD13381F4

SLPS448D – JULY 2013 – REVISED MAY 2015

www.ti.com

7.4 CSD13381F4 Embossed Carrier Tape Dimensions

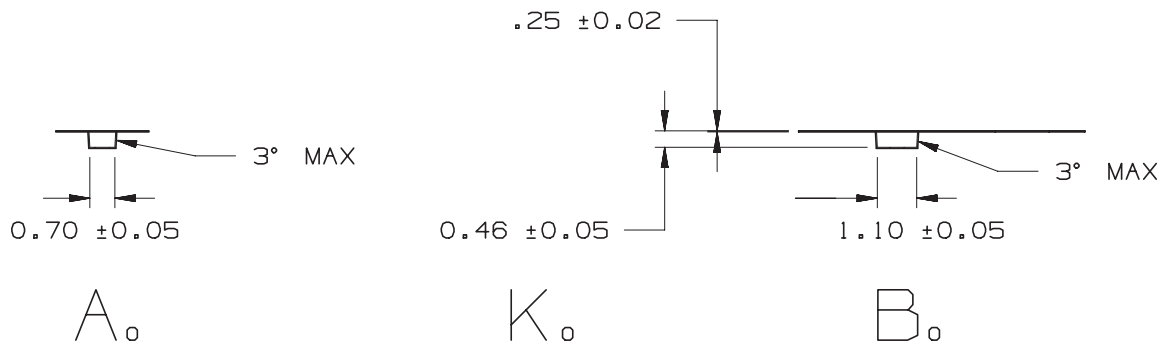
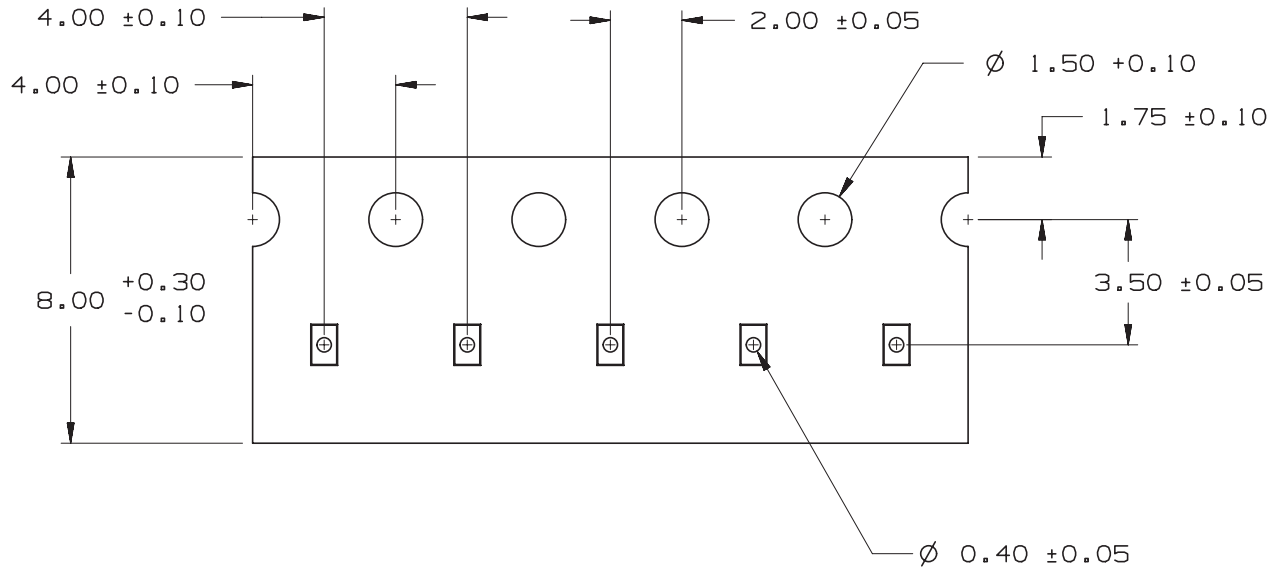

- (1) Pin 1 is oriented in the top-right quadrant of the tape enclosure (quadrant 2), closest to the carrier tape sprocket holes.

PACKAGING INFORMATION

Orderable Device	Status (1)	Package Type	Package Drawing	Pins	Package Qty	Eco Plan (2)	Lead/Ball Finish (6)	MSL Peak Temp (3)	Op Temp (°C)	Device Marking (4/5)	Samples
CSD13381F4	ACTIVE	PICOSTAR	YJC	3	3000	Green (RoHS & no Sb/Br)	Call TI	Level-1-260C-UNLIM	-55 to 150	DQ	Samples
CSD13381F4T	ACTIVE	PICOSTAR	YJC	3	250	Green (RoHS & no Sb/Br)	Call TI	Level-1-260C-UNLIM	-55 to 150	DQ	Samples

(1) The marketing status values are defined as follows:

ACTIVE: Product device recommended for new designs.

LIFEBUY: TI has announced that the device will be discontinued, and a lifetime-buy period is in effect.

NRND: Not recommended for new designs. Device is in production to support existing customers, but TI does not recommend using this part in a new design.

PREVIEW: Device has been announced but is not in production. Samples may or may not be available.

OBSELETE: TI has discontinued the production of the device.

(2) Eco Plan - The planned eco-friendly classification: Pb-Free (RoHS), Pb-Free (RoHS Exempt), or Green (RoHS & no Sb/Br) - please check <http://www.ti.com/productcontent> for the latest availability information and additional product content details.

TBD: The Pb-Free/Green conversion plan has not been defined.

Pb-Free (RoHS): TI's terms "Lead-Free" or "Pb-Free" mean semiconductor products that are compatible with the current RoHS requirements for all 6 substances, including the requirement that lead not exceed 0.1% by weight in homogeneous materials. Where designed to be soldered at high temperatures, TI Pb-Free products are suitable for use in specified lead-free processes.

Pb-Free (RoHS Exempt): This component has a RoHS exemption for either 1) lead-based flip-chip solder bumps used between the die and package, or 2) lead-based die adhesive used between the die and leadframe. The component is otherwise considered Pb-Free (RoHS compatible) as defined above.

Green (RoHS & no Sb/Br): TI defines "Green" to mean Pb-Free (RoHS compatible), and free of Bromine (Br) and Antimony (Sb) based flame retardants (Br or Sb do not exceed 0.1% by weight in homogeneous material)

(3) MSL, Peak Temp. - The Moisture Sensitivity Level rating according to the JEDEC industry standard classifications, and peak solder temperature.

(4) There may be additional marking, which relates to the logo, the lot trace code information, or the environmental category on the device.

(5) Multiple Device Markings will be inside parentheses. Only one Device Marking contained in parentheses and separated by a "~" will appear on a device. If a line is indented then it is a continuation of the previous line and the two combined represent the entire Device Marking for that device.

(6) Lead/Ball Finish - Orderable Devices may have multiple material finish options. Finish options are separated by a vertical ruled line. Lead/Ball Finish values may wrap to two lines if the finish value exceeds the maximum column width.

Important Information and Disclaimer: The information provided on this page represents TI's knowledge and belief as of the date that it is provided. TI bases its knowledge and belief on information provided by third parties, and makes no representation or warranty as to the accuracy of such information. Efforts are underway to better integrate information from third parties. TI has taken and continues to take reasonable steps to provide representative and accurate information but may not have conducted destructive testing or chemical analysis on incoming materials and chemicals. TI and TI suppliers consider certain information to be proprietary, and thus CAS numbers and other limited information may not be available for release.

In no event shall TI's liability arising out of such information exceed the total purchase price of the TI part(s) at issue in this document sold by TI to Customer on an annual basis.

IMPORTANT NOTICE

Texas Instruments Incorporated and its subsidiaries (TI) reserve the right to make corrections, enhancements, improvements and other changes to its semiconductor products and services per JESD46, latest issue, and to discontinue any product or service per JESD48, latest issue. Buyers should obtain the latest relevant information before placing orders and should verify that such information is current and complete. All semiconductor products (also referred to herein as "components") are sold subject to TI's terms and conditions of sale supplied at the time of order acknowledgment.

TI warrants performance of its components to the specifications applicable at the time of sale, in accordance with the warranty in TI's terms and conditions of sale of semiconductor products. Testing and other quality control techniques are used to the extent TI deems necessary to support this warranty. Except where mandated by applicable law, testing of all parameters of each component is not necessarily performed.

TI assumes no liability for applications assistance or the design of Buyers' products. Buyers are responsible for their products and applications using TI components. To minimize the risks associated with Buyers' products and applications, Buyers should provide adequate design and operating safeguards.

TI does not warrant or represent that any license, either express or implied, is granted under any patent right, copyright, mask work right, or other intellectual property right relating to any combination, machine, or process in which TI components or services are used. Information published by TI regarding third-party products or services does not constitute a license to use such products or services or a warranty or endorsement thereof. Use of such information may require a license from a third party under the patents or other intellectual property of the third party, or a license from TI under the patents or other intellectual property of TI.

Reproduction of significant portions of TI information in TI data books or data sheets is permissible only if reproduction is without alteration and is accompanied by all associated warranties, conditions, limitations, and notices. TI is not responsible or liable for such altered documentation. Information of third parties may be subject to additional restrictions.

Resale of TI components or services with statements different from or beyond the parameters stated by TI for that component or service voids all express and any implied warranties for the associated TI component or service and is an unfair and deceptive business practice. TI is not responsible or liable for any such statements.

Buyer acknowledges and agrees that it is solely responsible for compliance with all legal, regulatory and safety-related requirements concerning its products, and any use of TI components in its applications, notwithstanding any applications-related information or support that may be provided by TI. Buyer represents and agrees that it has all the necessary expertise to create and implement safeguards which anticipate dangerous consequences of failures, monitor failures and their consequences, lessen the likelihood of failures that might cause harm and take appropriate remedial actions. Buyer will fully indemnify TI and its representatives against any damages arising out of the use of any TI components in safety-critical applications.

In some cases, TI components may be promoted specifically to facilitate safety-related applications. With such components, TI's goal is to help enable customers to design and create their own end-product solutions that meet applicable functional safety standards and requirements. Nonetheless, such components are subject to these terms.

No TI components are authorized for use in FDA Class III (or similar life-critical medical equipment) unless authorized officers of the parties have executed a special agreement specifically governing such use.

Only those TI components which TI has specifically designated as military grade or "enhanced plastic" are designed and intended for use in military/aerospace applications or environments. Buyer acknowledges and agrees that any military or aerospace use of TI components which have **not** been so designated is solely at the Buyer's risk, and that Buyer is solely responsible for compliance with all legal and regulatory requirements in connection with such use.

TI has specifically designated certain components as meeting ISO/TS16949 requirements, mainly for automotive use. In any case of use of non-designated products, TI will not be responsible for any failure to meet ISO/TS16949.

Products

Audio	www.ti.com/audio
Amplifiers	amplifier.ti.com
Data Converters	dataconverter.ti.com
DLP® Products	www.dlp.com
DSP	dsp.ti.com
Clocks and Timers	www.ti.com/clocks
Interface	interface.ti.com
Logic	logic.ti.com
Power Mgmt	power.ti.com
Microcontrollers	microcontroller.ti.com
RFID	www.ti-rfid.com
OMAP Applications Processors	www.ti.com/omap
Wireless Connectivity	www.ti.com/wirelessconnectivity

Applications

Automotive and Transportation	www.ti.com/automotive
Communications and Telecom	www.ti.com/communications
Computers and Peripherals	www.ti.com/computers
Consumer Electronics	www.ti.com/consumer-apps
Energy and Lighting	www.ti.com/energy
Industrial	www.ti.com/industrial
Medical	www.ti.com/medical
Security	www.ti.com/security
Space, Avionics and Defense	www.ti.com/space-avionics-defense
Video and Imaging	www.ti.com/video

TI E2E Community

e2e.ti.com