

DETAILS

Product Number	CS12862_STRADA-IP-2X6-DWC
Family	Strada-IP
Type	Assembly
Color	clear
Diameter	173x71,4 mm
Height	7,92 mm
Style	rectang
Optic Material	PMMA
Holder Material	
Fastening	pin, screw
Status	production ready
ROHS Compliant	Yes
Date Updated	4/11/2016



OPTICAL PROPERTIES

LED	Viewing Angle	Light Beam	Efficiency	cd/lm	Connector
XT-E	Asymmetric deg	Asymmetric	94 %	0.540	-
XP-G	Asymmetric deg	Asymmetric	96 %	0.540	-
XP-G2	Asymmetric deg	Asymmetric	94 %	0.600	-
XB-D	sim: Asymmetric	Asymmetric	-	-	-
XP-G3	Asymmetric deg	Asymmetric	94 %	0.520	-
H35C1 (LEMWA33)	Asymmetric deg	Asymmetric	94 %	0.500	-
LUXEON R	Asymmetric deg	Asymmetric	96 %	0.580	-
LUXEON Rebel ES	Asymmetric deg	Asymmetric	96 %	0.560	-
LUXEON T	Asymmetric deg	Asymmetric	95 %	0.580	-
LUXEON H50-2	sim: Asymmetric	Asymmetric	sim: 90 %	-	-
LUXEON TX	sim: Asymmetric	Asymmetric	sim: 89 %	sim: 0.500	-
NVSxx19B/NVSxx19C	Asymmetric deg	Asymmetric	94 %	0.570	-
Oslon Square PC	Asymmetric deg	Asymmetric	96 %	0.570	-
Duris S8	sim: Asymmetric	Asymmetric	sim: 91 %	sim: 0.470	-
Duris P8	sim: Asymmetric	Asymmetric	sim: 90 %	sim: 0.540	-
LH351Z	asymmetric deg	Asymmetric	94 %	0.570	-
Z5M	sim: Asymmetric	Asymmetric	sim: 89 %	sim: 0.490	-
Z5M1/Z5M2	sim: Asymmetric	Asymmetric	sim: 90 %	sim: 0.640	-
Z8Y22P	Asymmetric deg	Asymmetric	94 %	0.530	-
TL1L3	sim: Asymmetric	Asymmetric	sim: 86 %	-	-
TL1L2	sim: Asymmetric	Asymmetric	sim: 88 %	-	-
TL1L4	Asymmetric deg	Asymmetric	94 %	0.570	-

Absolute intensity of CS12862_STRADA-IP-2X6-DWC_(XT-E)

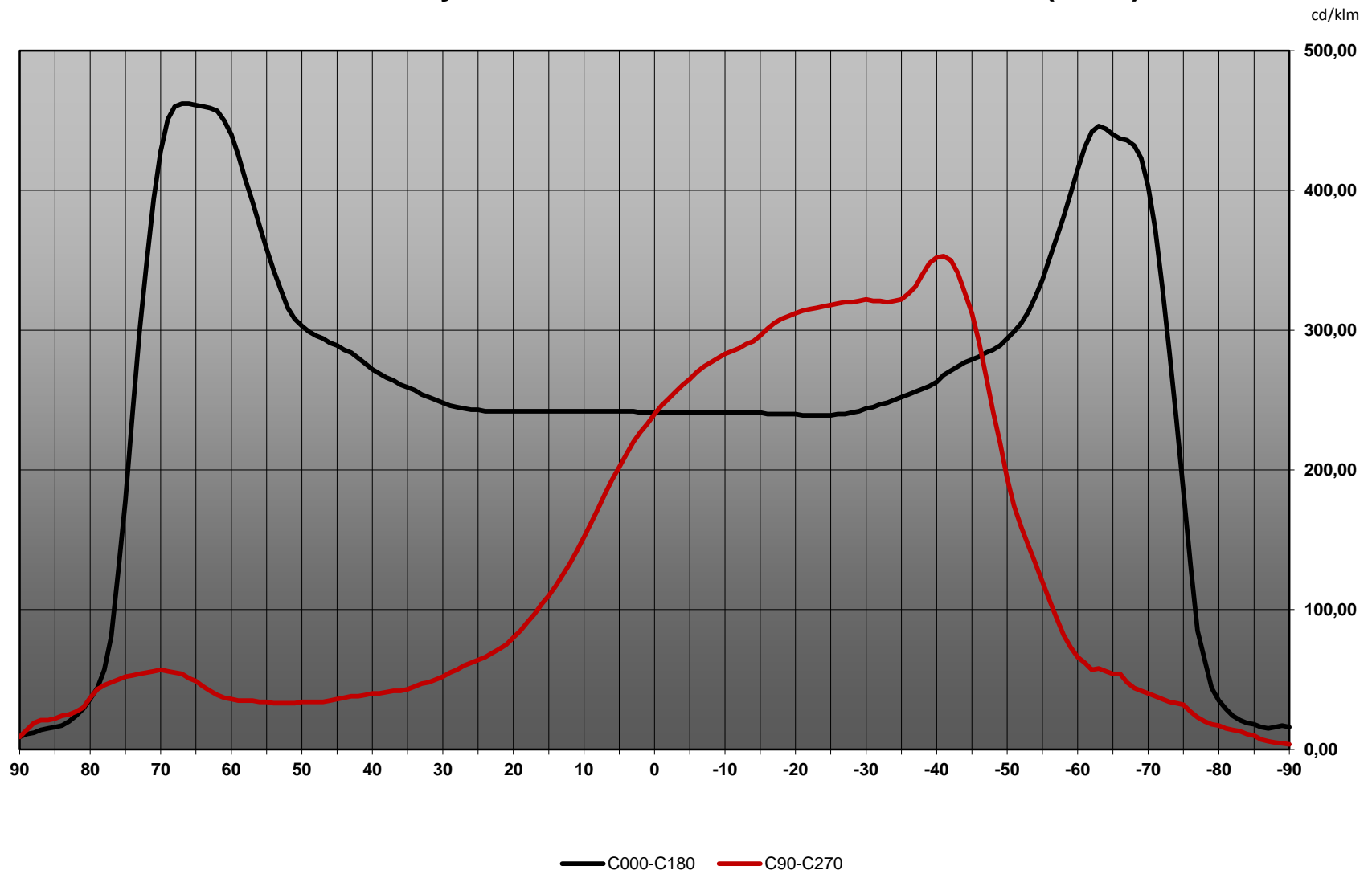

Absolute intensity of CS12862_STRADA-IP-2X6-DWC_(SQ-PC)

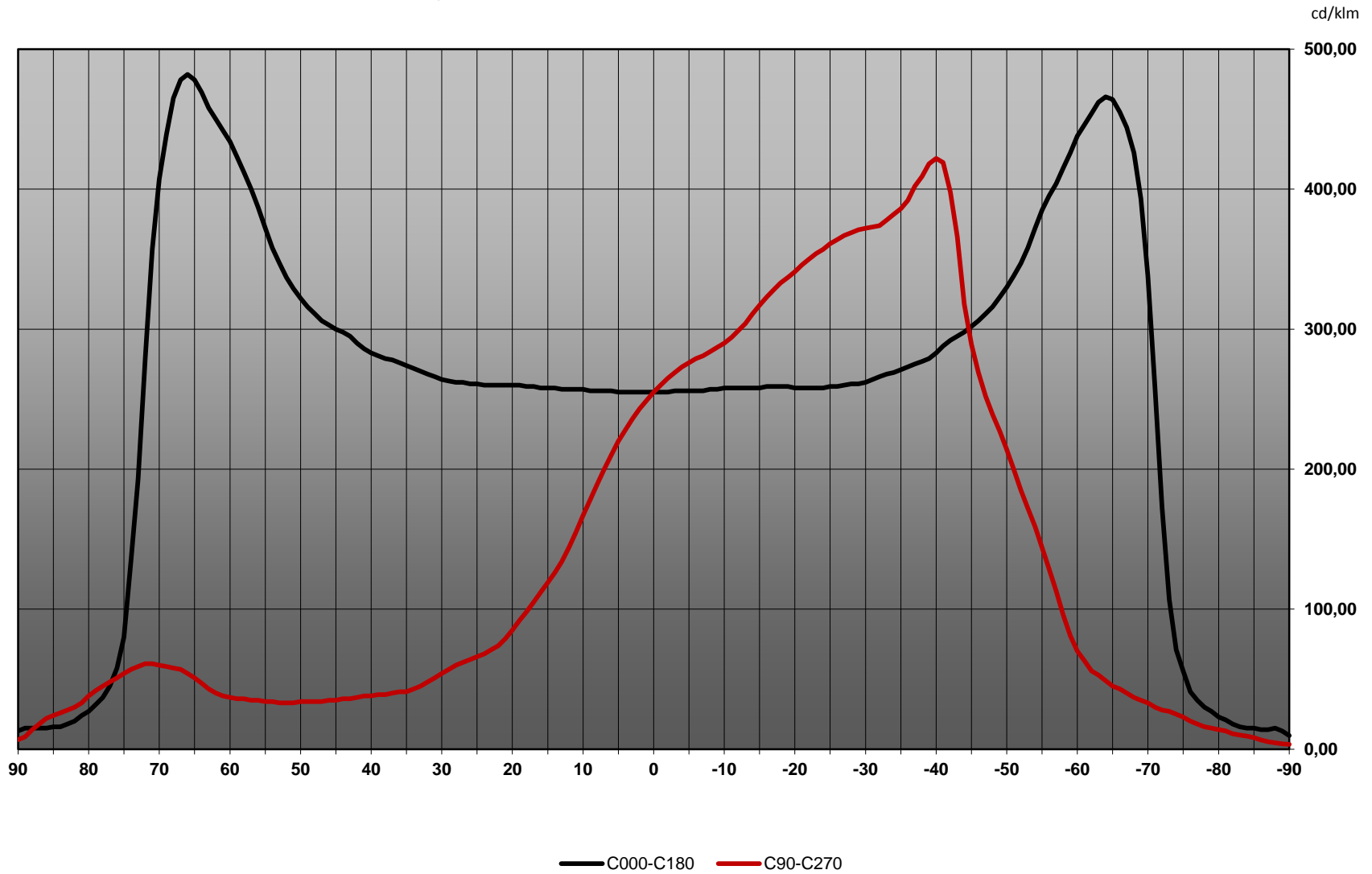

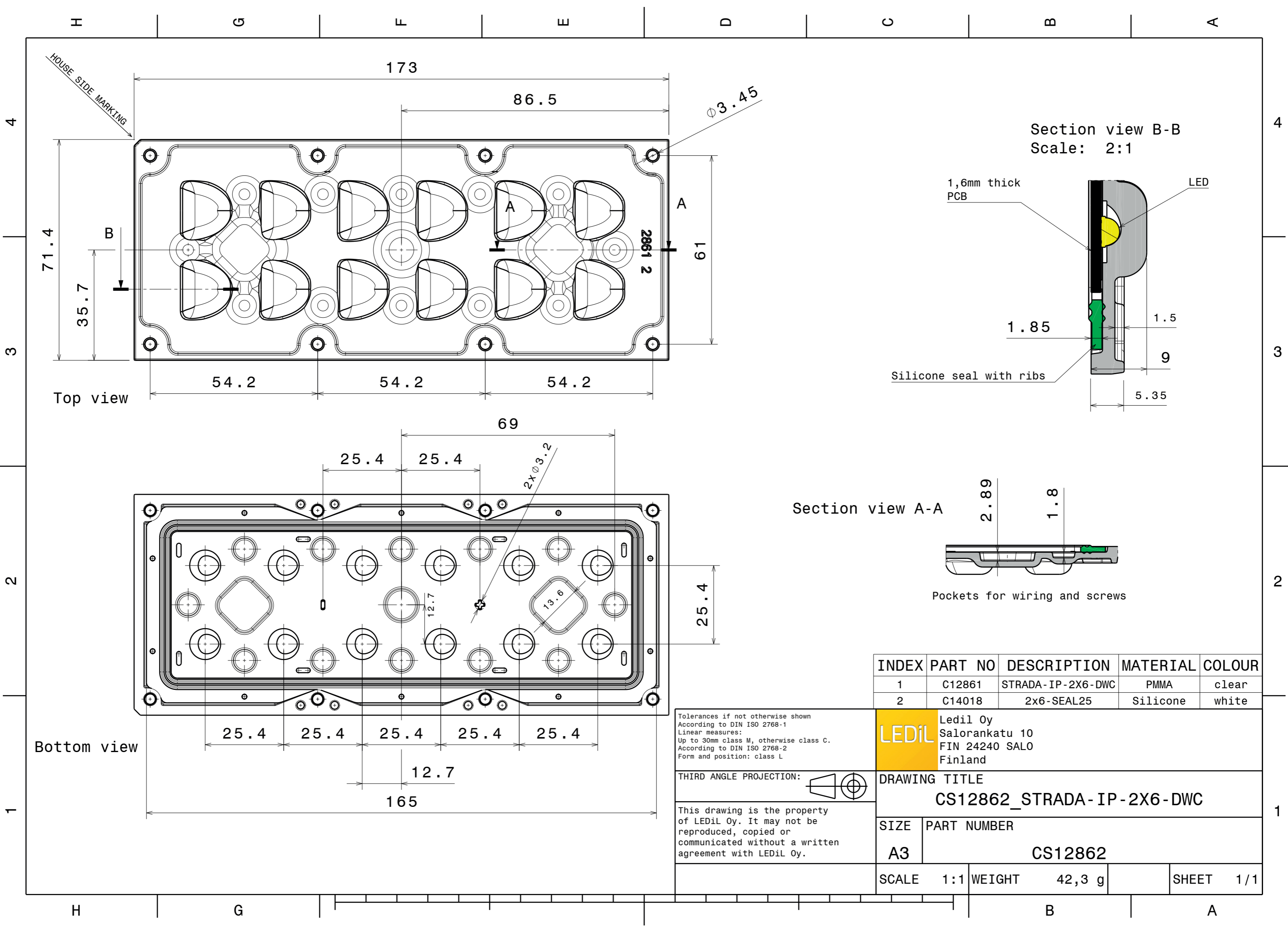

Section view B-B
Scale: 2:1

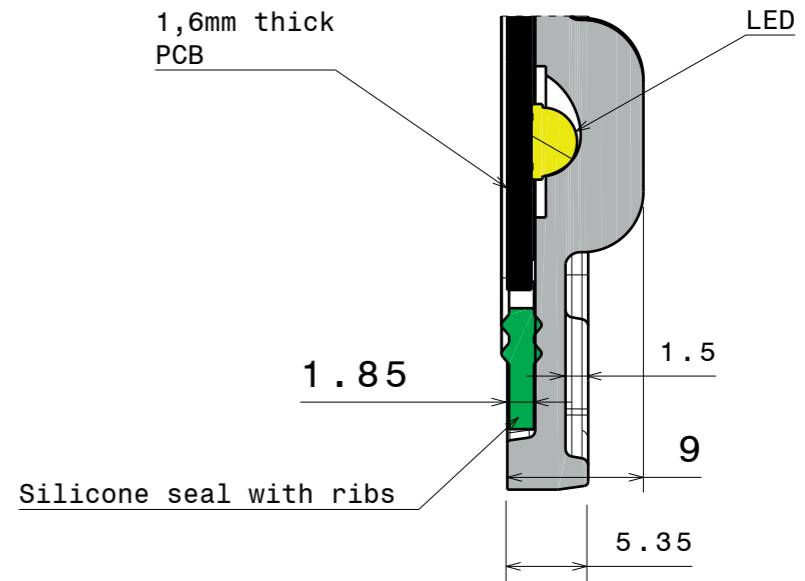

Section view A-A

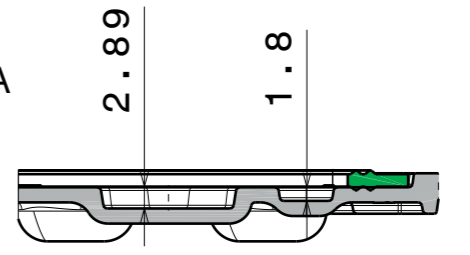

INDEX	PART NO	DESCRIPTION	MATERIAL	COLOUR
1	C12861	STRADA-IP-2X6-DWC	PMMA	clear
2	C14018	2x6-SEAL25	Silicone	white

Tolerances if not otherwise shown
According to DIN ISO 2768-1
Linear measures:
Up to 30mm class M, otherwise class C.
According to DIN ISO 2768-2
Form and position: class L

LEDiL Ledil Oy
Salorankatu 10
FIN 24240 SALO
Finland

THIRD ANGLE PROJECTION:

DRAWING TITLE
CS12862_STRADA-IP-2X6-DWC

This drawing is the property of LEDiL Oy. It may not be reproduced, copied or communicated without a written agreement with LEDiL Oy.

SIZE PART NUMBER
A3 CS12862

SCALE 1:1 WEIGHT 42,3 g SHEET 1/1

Luminaire: LEDIL OY CS12862_STRADA-IP-2X6-DWC_(XT-E) Eff.94.4%
Lamps: 1 x Cree XT-E (1188lm@250mA)

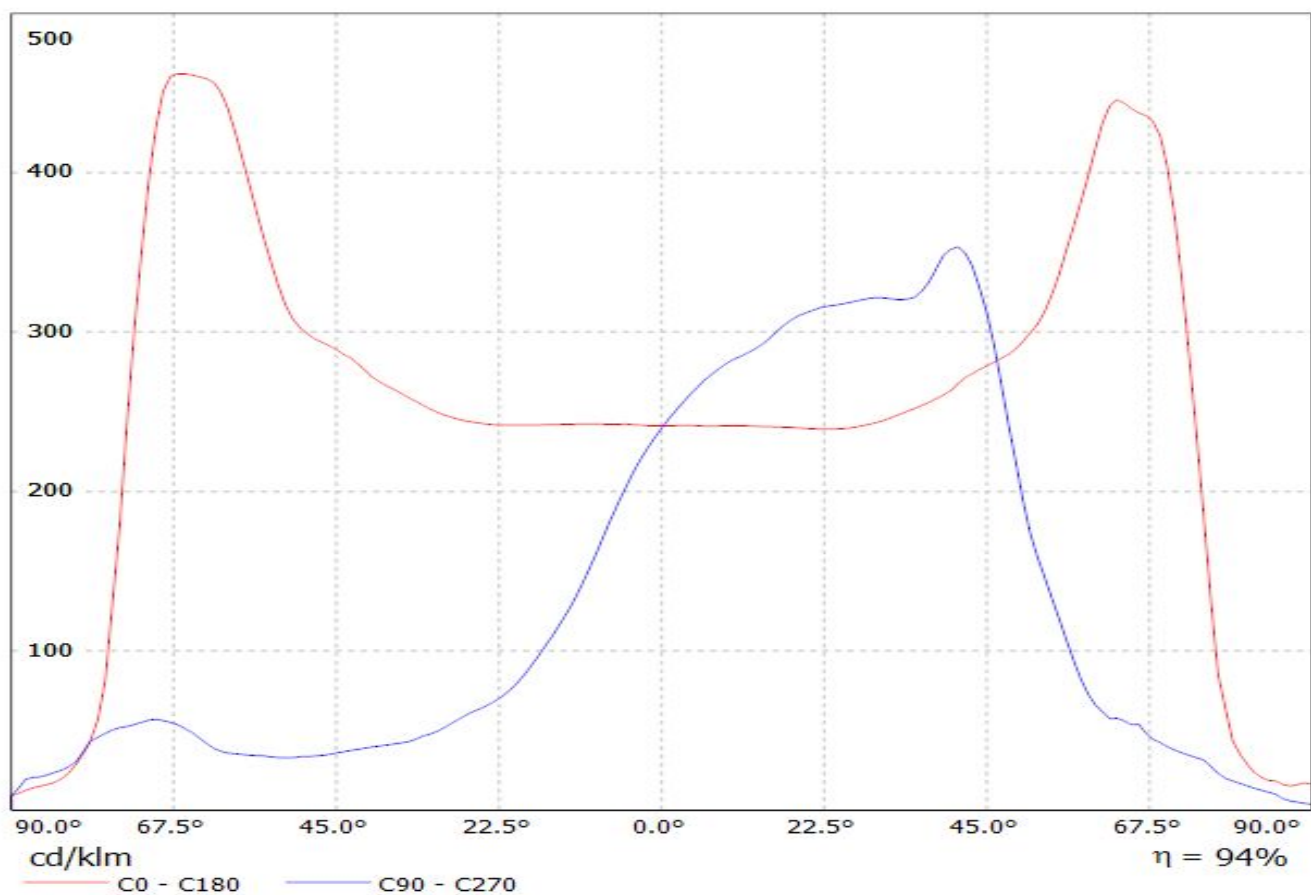

Luminaire: LEDiL Oy CS12862_STRADA-IP-2X6-DWC_(XP-G) Eff.96%
Lamps: 1 x Cree XP-G (787.883lm@250mA)

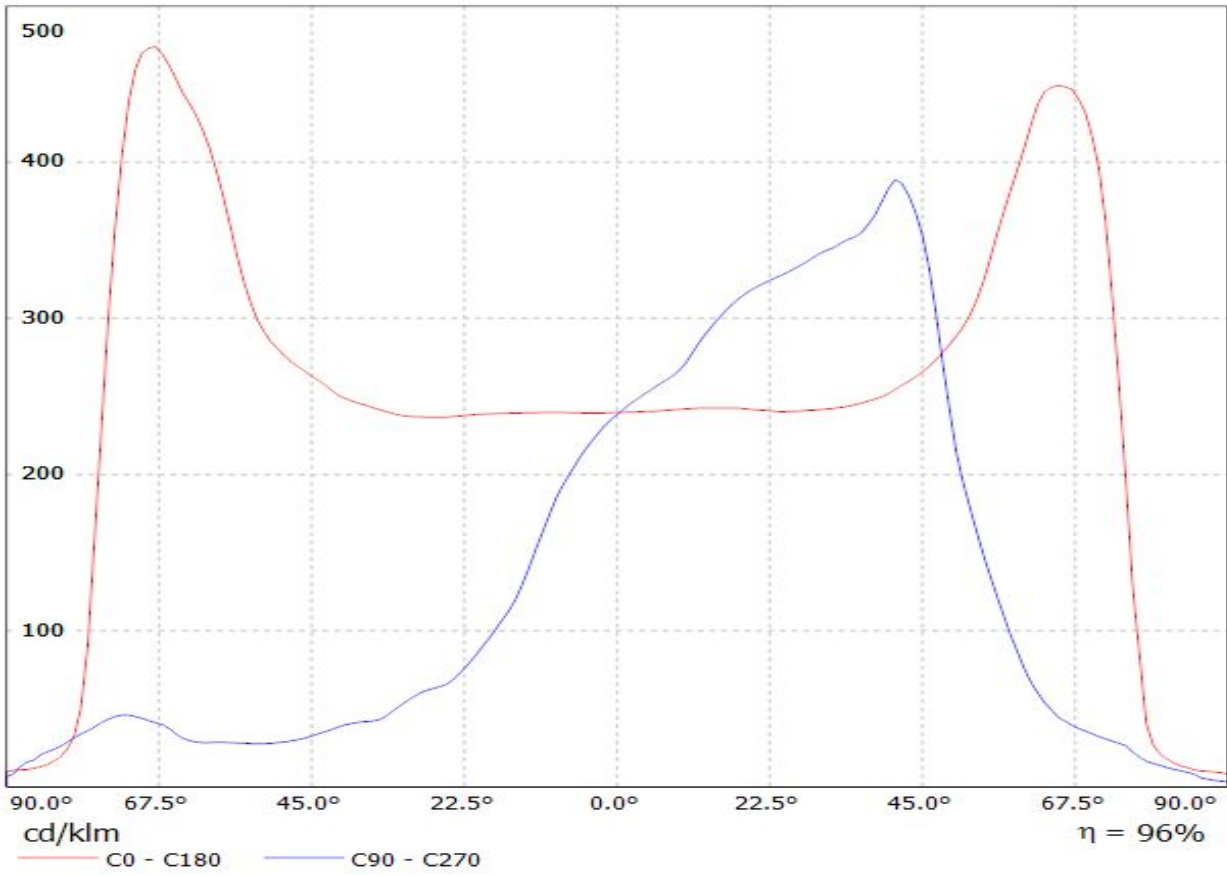

Luminaire: LEDiL Oy CS12862_STRADA-IP-2X6-DWC_(XP-G2) Eff: 94%
Lamps: 1 x CREE_XP-G2_1303lm@250mA_P=8.58363W_I=249.8mA

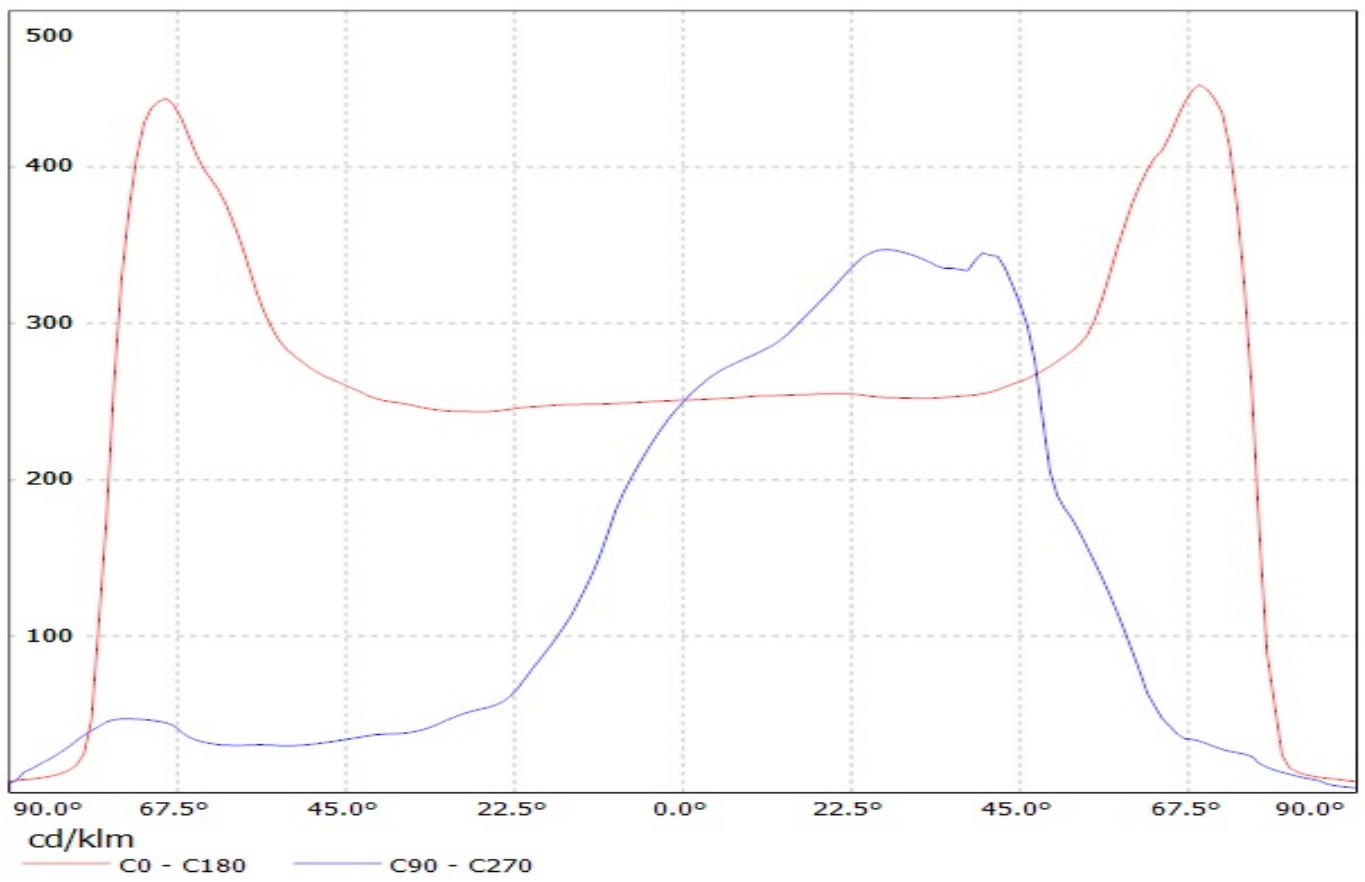

Luminaire: Ledil CS12862_STRADA-IP-2X6-DWC_(XP-G3)

Lamps: 1 x Cree_XP-G3_6x2_(XPGDWT-B1-6C1-S3-0-01)_1521.26lm@250mA_P=8.253W_I=0.25A

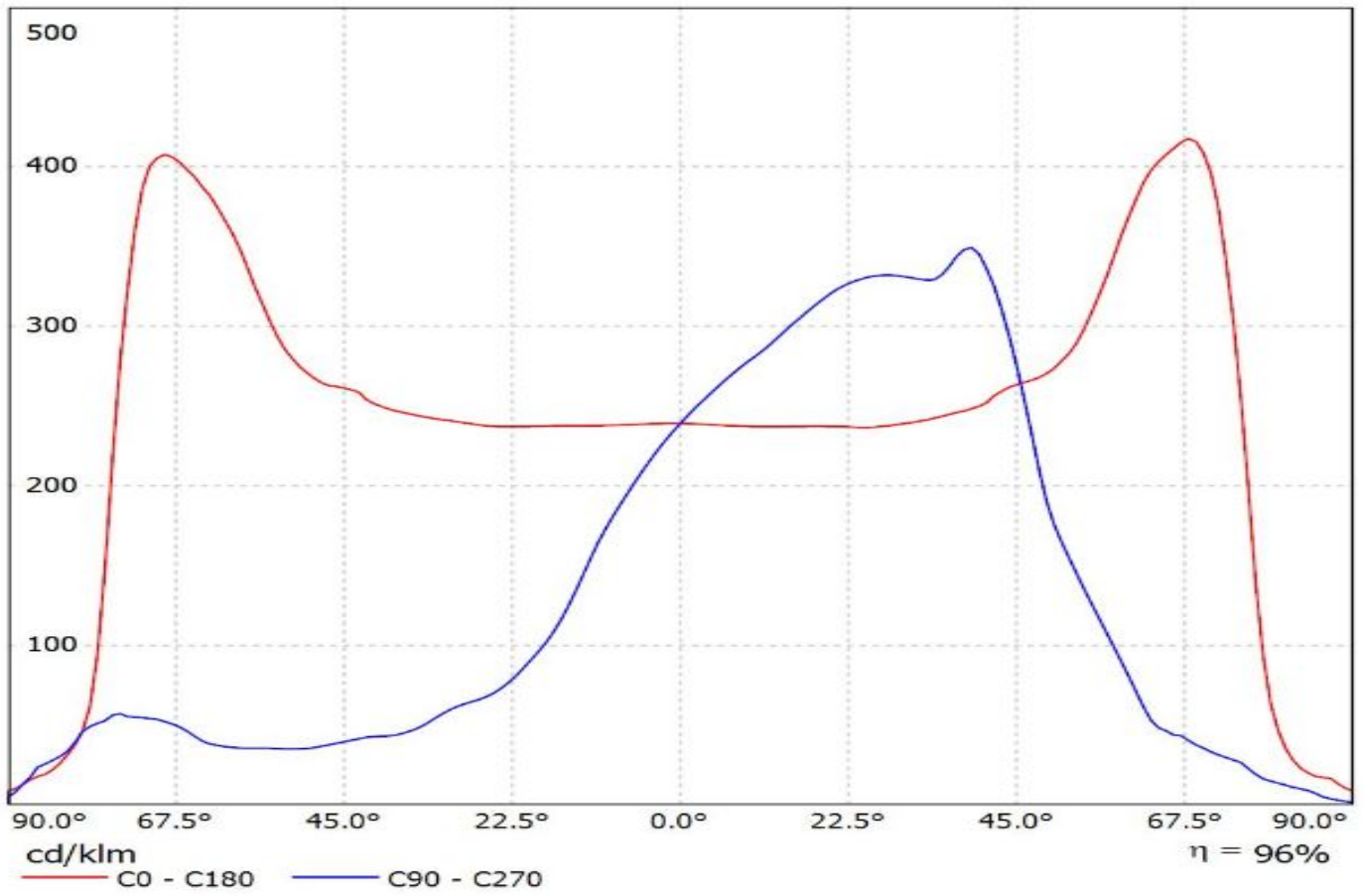

Luminaire: Ledil CS12862_STRADA-IP-2X6-DWC_(H35C1)
Lamps: 1 x LG_H35C1_2x6_1389.53lm@250mA_CCT=5700_P=8.59425W_I=0.250A

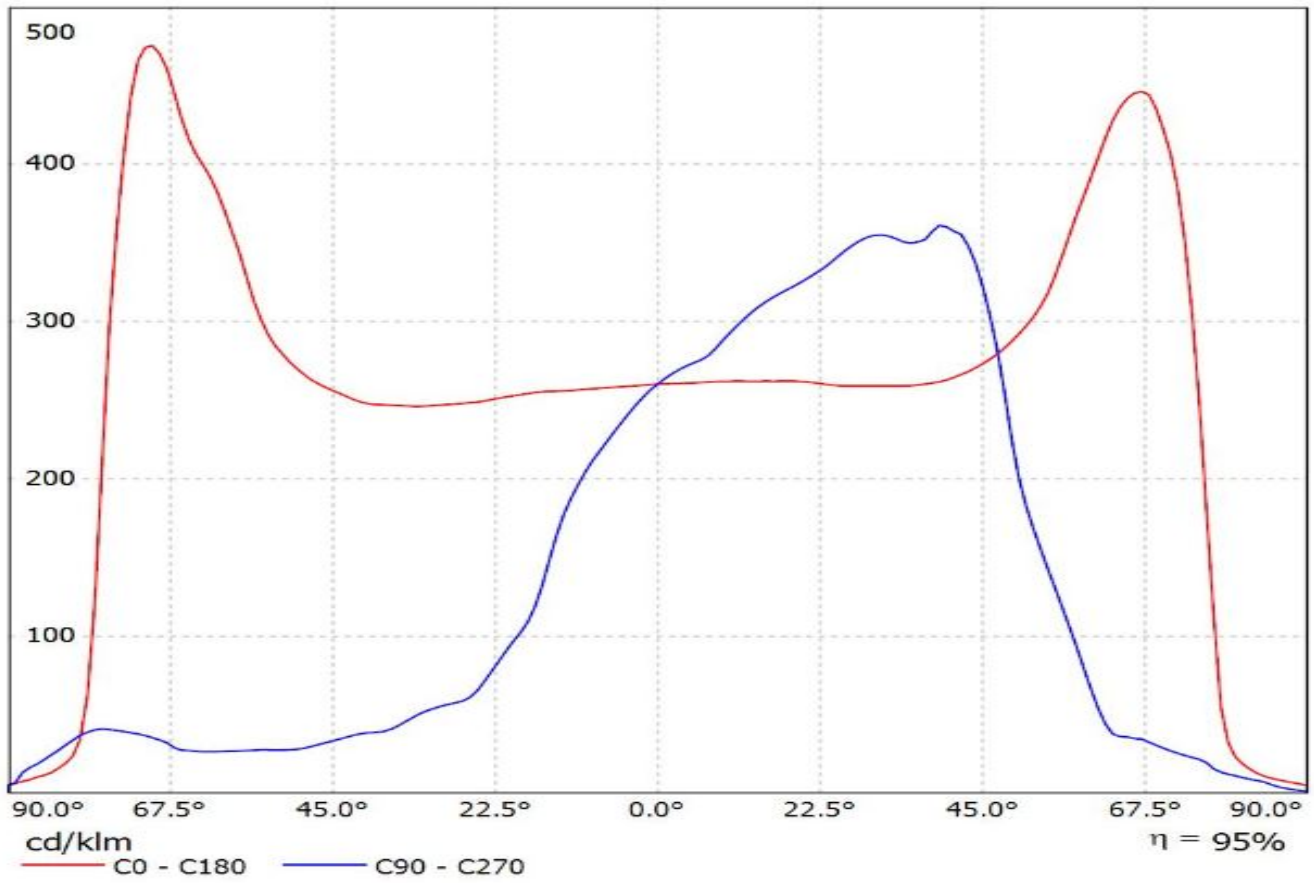

Luminaire: LEDiL Oy CS12862_STRADA-IP-2X6-DWC_(Luxeon_T)_3
Lamps: 1 x Luxeon T 2x6 (LXH8-FW30) 1044.17lm@250mA P=8.46372W I=0.2498A

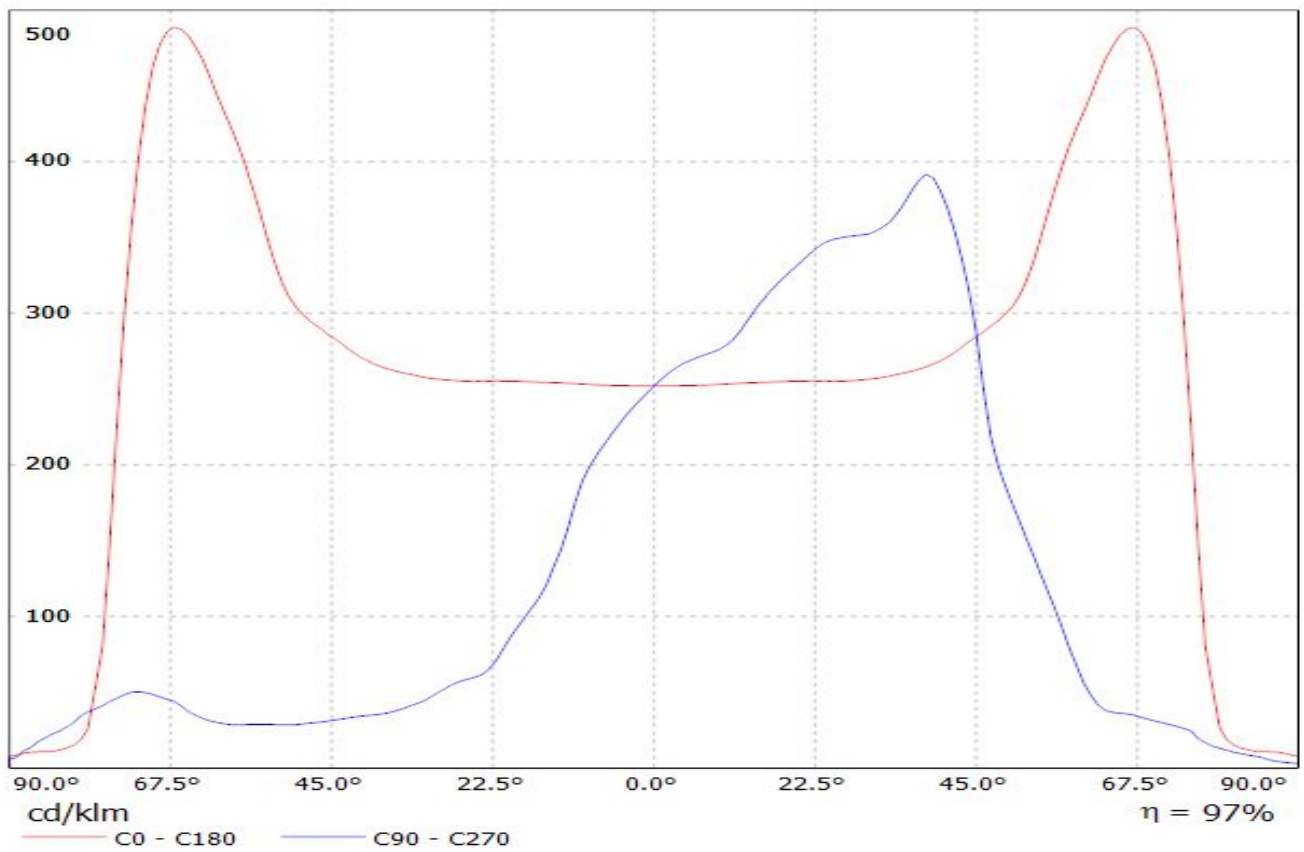

Luminaire: Ledil CS12862_STRADA-IP-2X6-DWC_(NVSL219CT)

Lamps: 1 x Nichia_NVSL219CT_2x6_1262.53lm@250mA_P=8.35825W_I=0.25A

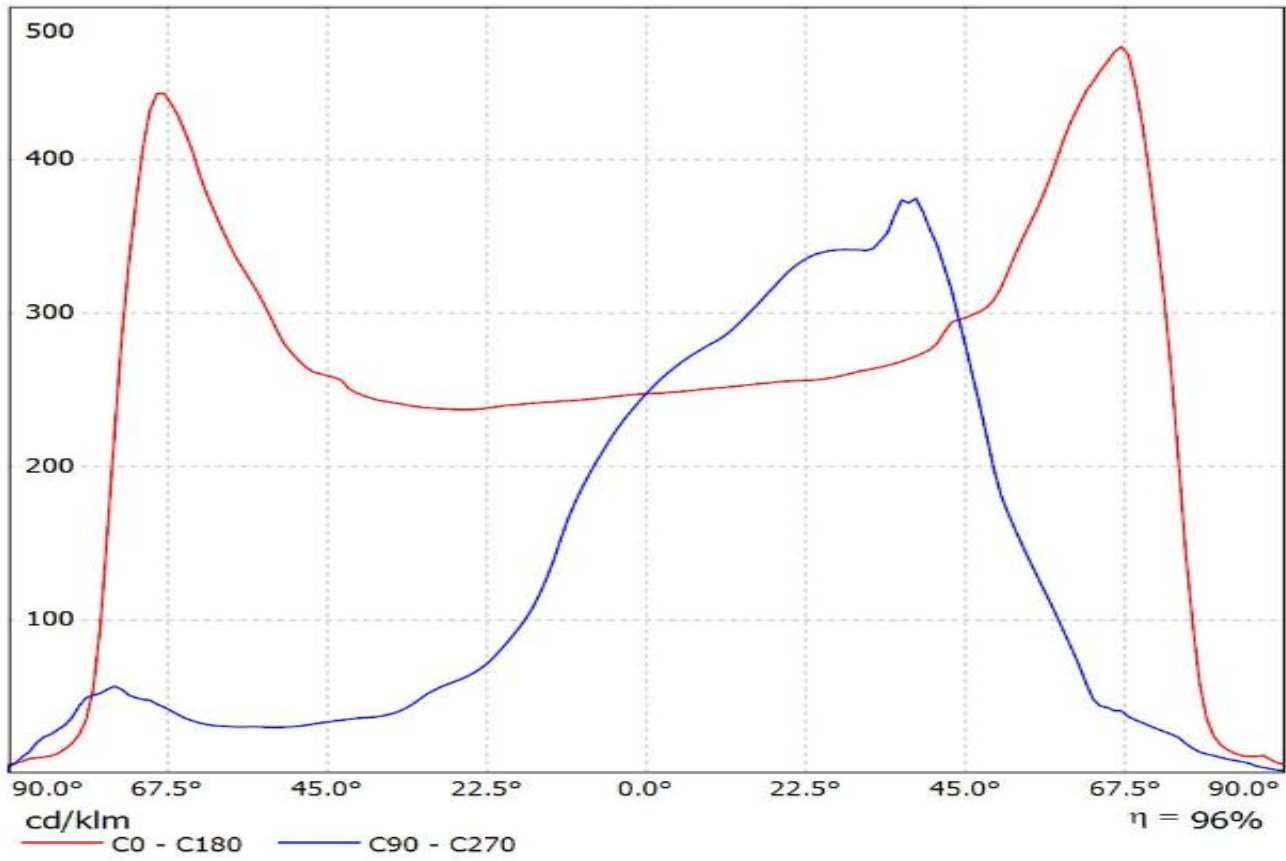

Luminaire: LEDiL Oy CS12862_STRADA-IP-2X6-DWC_(SQ-PC) Eff.96%
Lamps: 1 x Oslon SQ PC (1173.81lm@250mA)

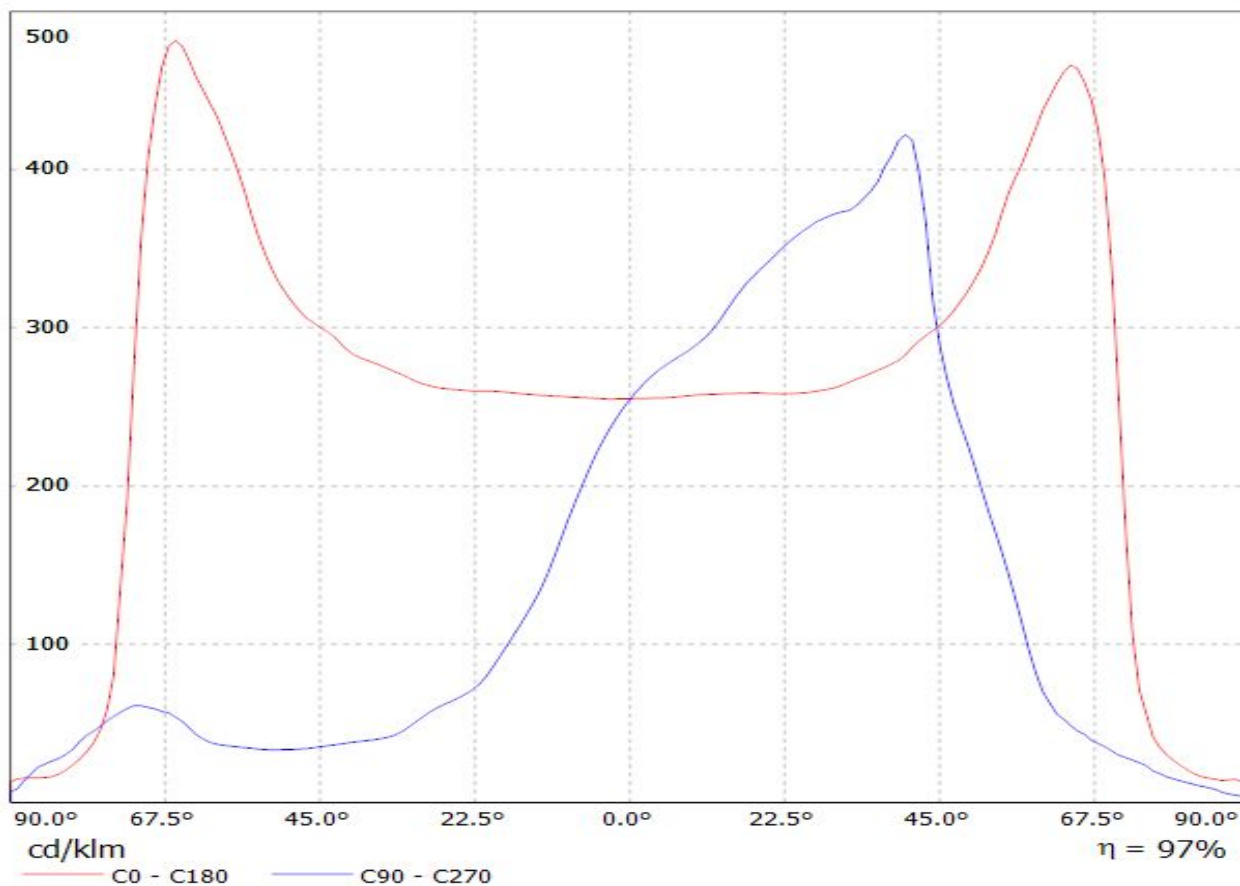

Luminaire: Ledil Oy CS12862_STRADA-IP-2X6-DWC_(Duris_P8)_SIMULATED
Lamps: 1 x Osram Duris P8

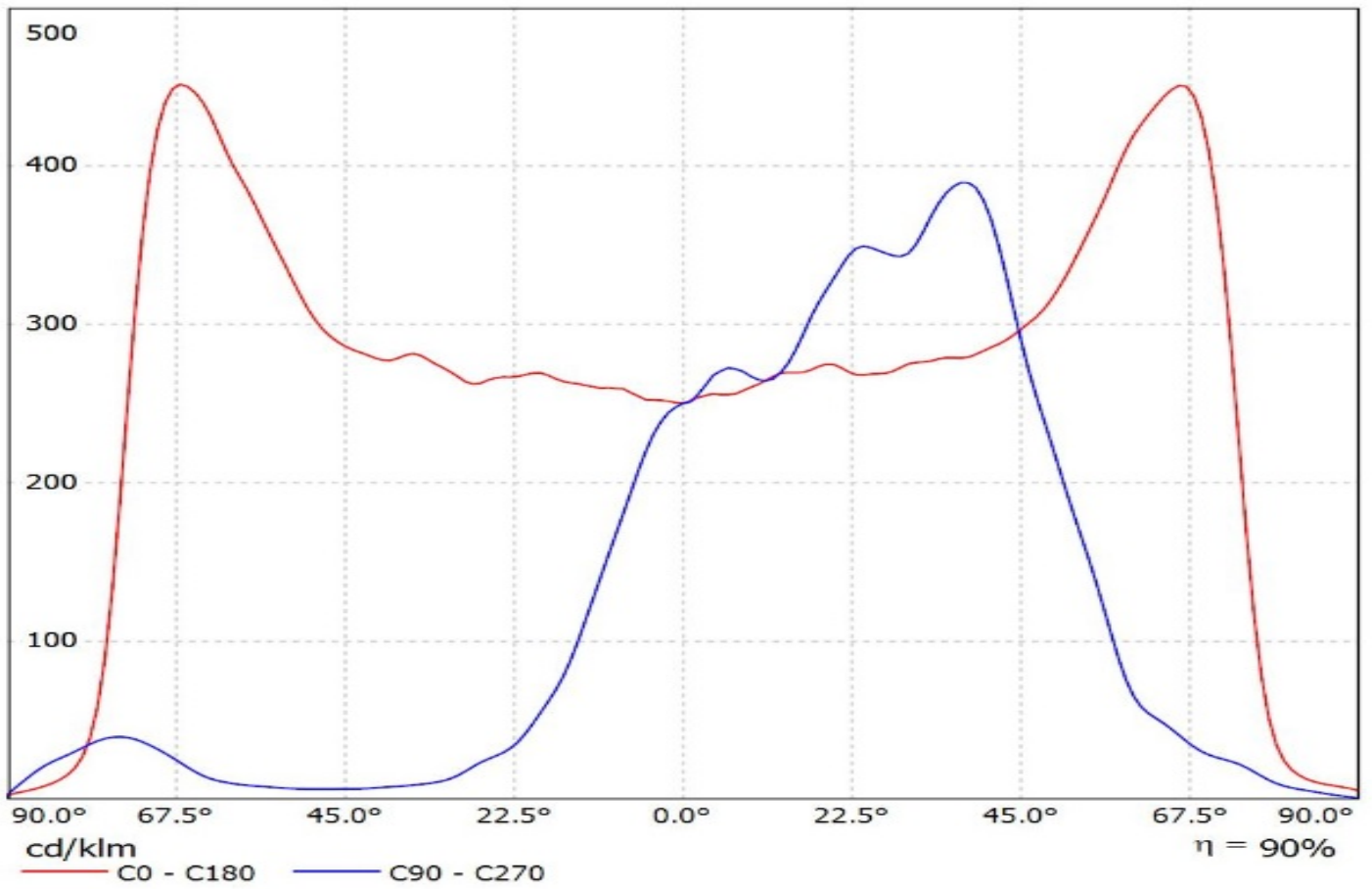

Luminaire: LEDiL Oy CS12862_STRADA-IP-2X6-DWC_(LH351Z)
Lamps: 1 x SAMSUNG_LH351Z_2x6_958.45lm@250mA_P=8.67003W_I=249.9mA

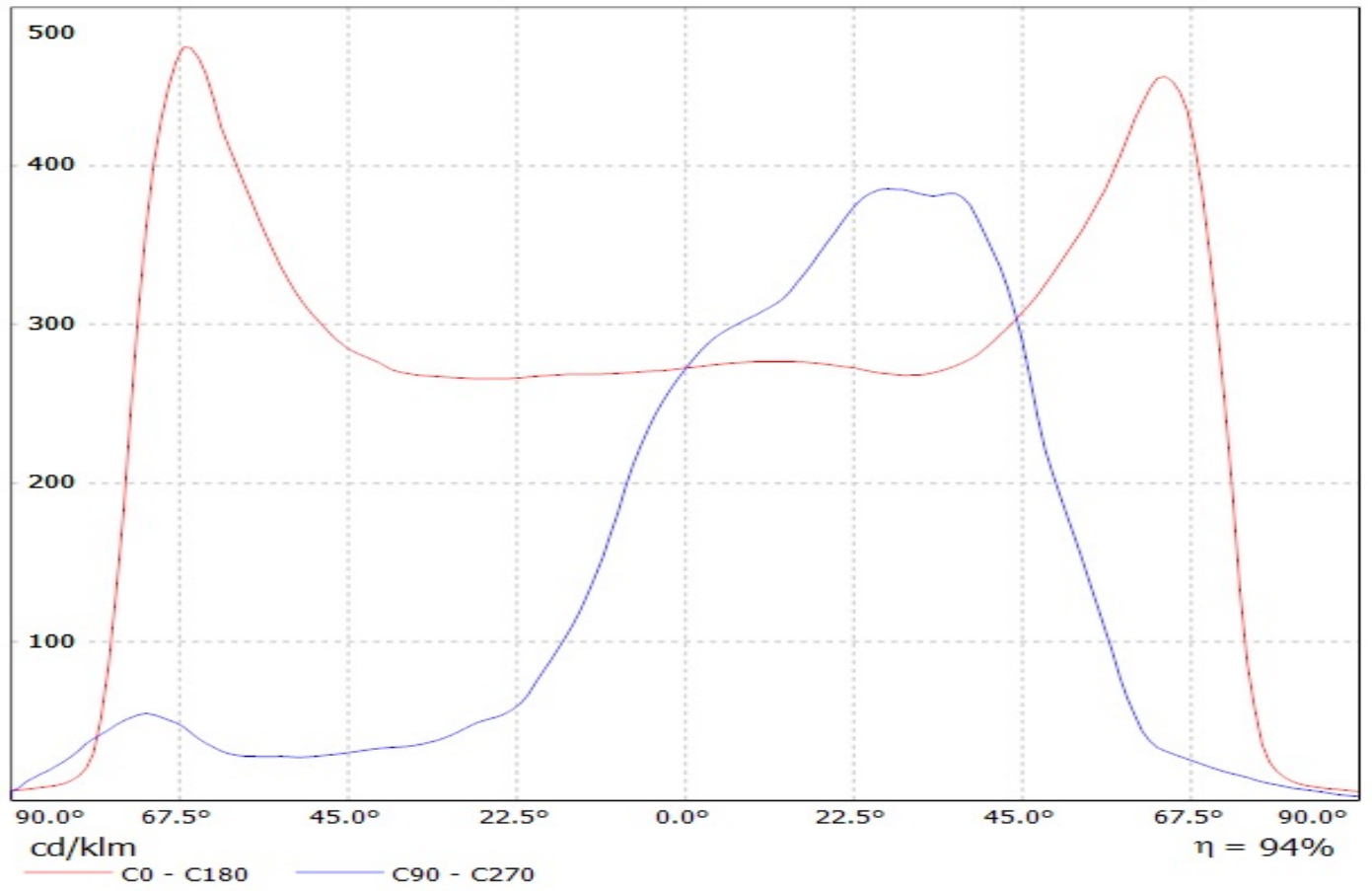

Ledil Oy CS12862_STRADA-IP-2X6-DWC-Seoul-Z5M_SIMULATED / LDC
(Linear)

Luminaire: Ledil Oy CS12862_STRADA-IP-2X6-DWC-Seoul-Z5M_SIMULATED
Lamps: 1 x Seoul Z5M

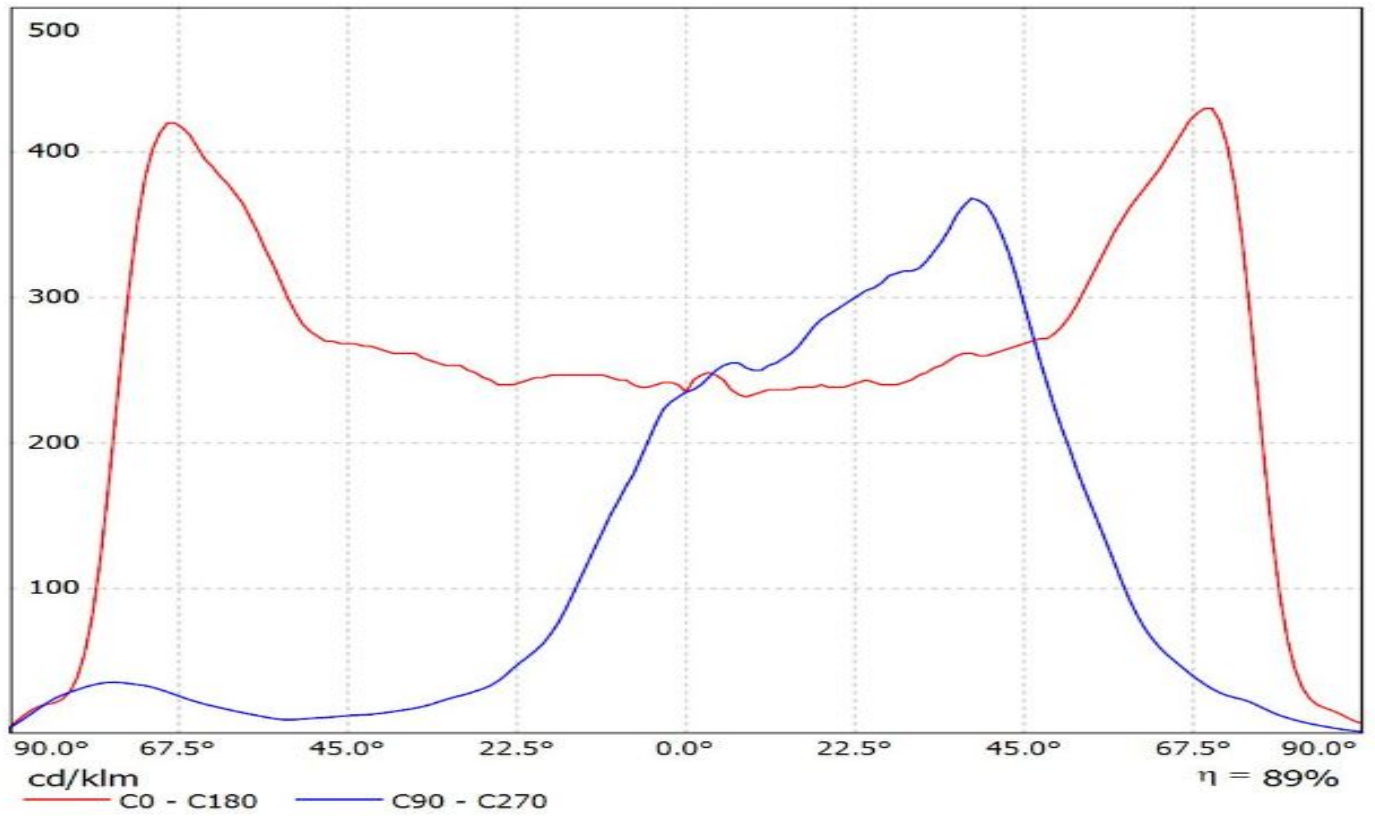

Luminaire: Ledil Oy CS12862_STRADA-IP-2X6-DWC_(Z5M1)_SIMULATED
Lamps: 1 x Seoul Z5M1

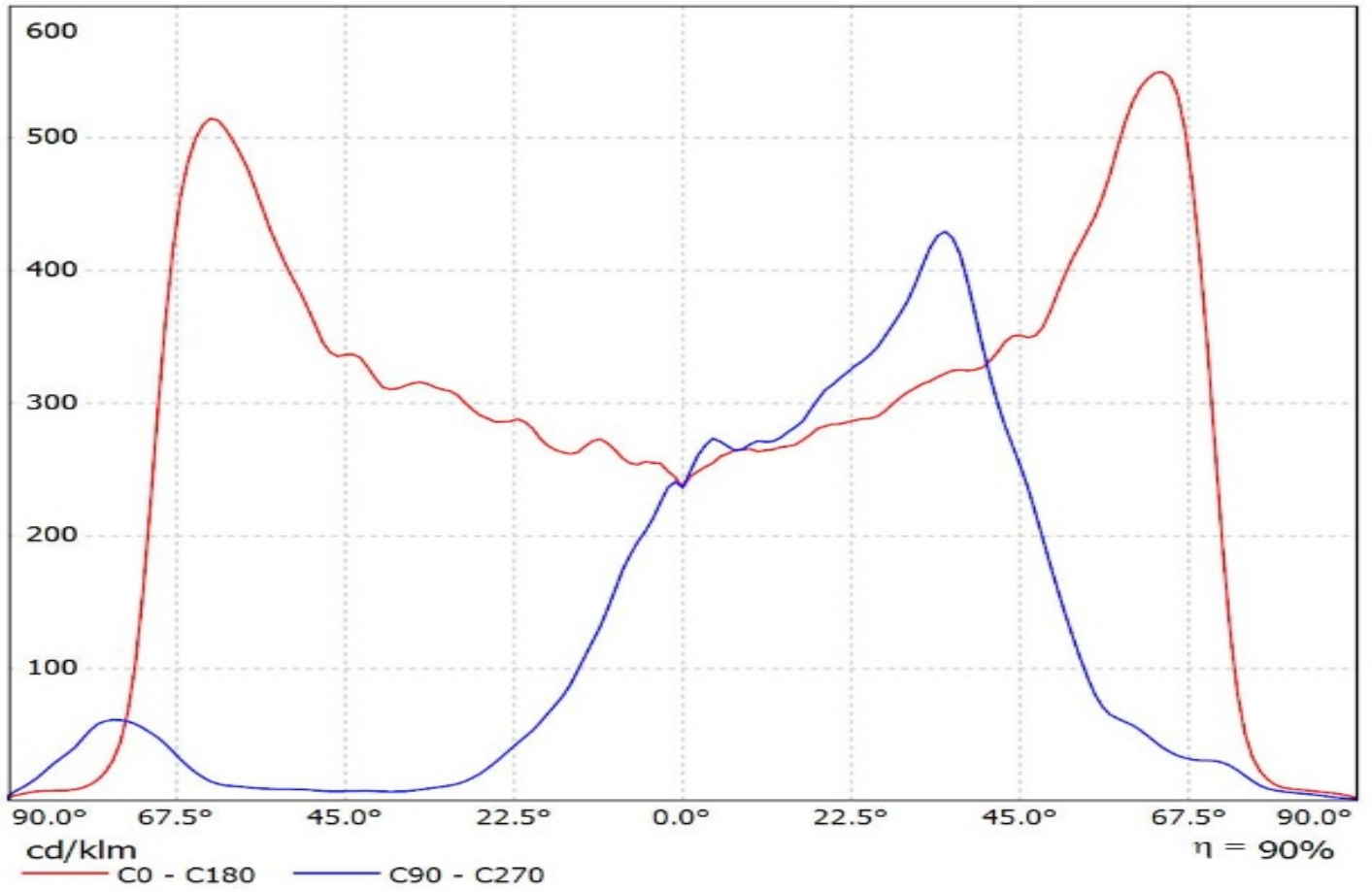

Luminaire: Ledil CS12862_STRADA-IP-2X6-DWC_(Z8Y22_PLUS)

Lamps: 1 x Seoul_Z8Y22_PLUS_2X6_(SZ8-Y22-W0-C7P)1489.65lm@250mA_P=8.30675W_η=0.250A

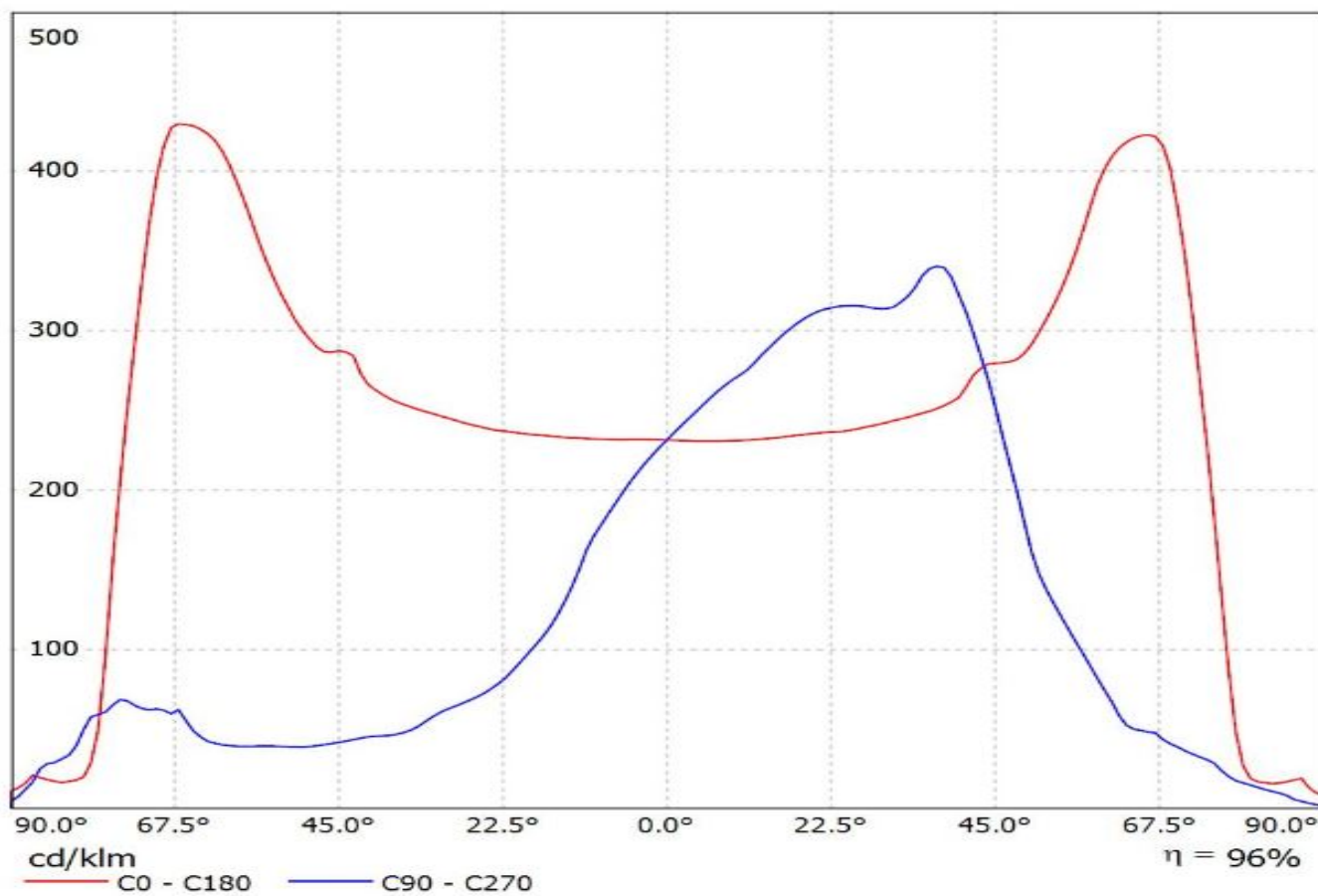

Ledil CS12862_STRADA-IP-2X6-DWC_(TL1L4) / LDC (Linear)

Luminaire: Ledil CS12862_STRADA-IP-2X6-DWC_(TL1L4)

Lamps: 1 x Toshiba_TL1L4_2x6_(TL1L4-DW0)_1346.96lm@250mA_CCT=6500K_P=8.5W_I=0.25A

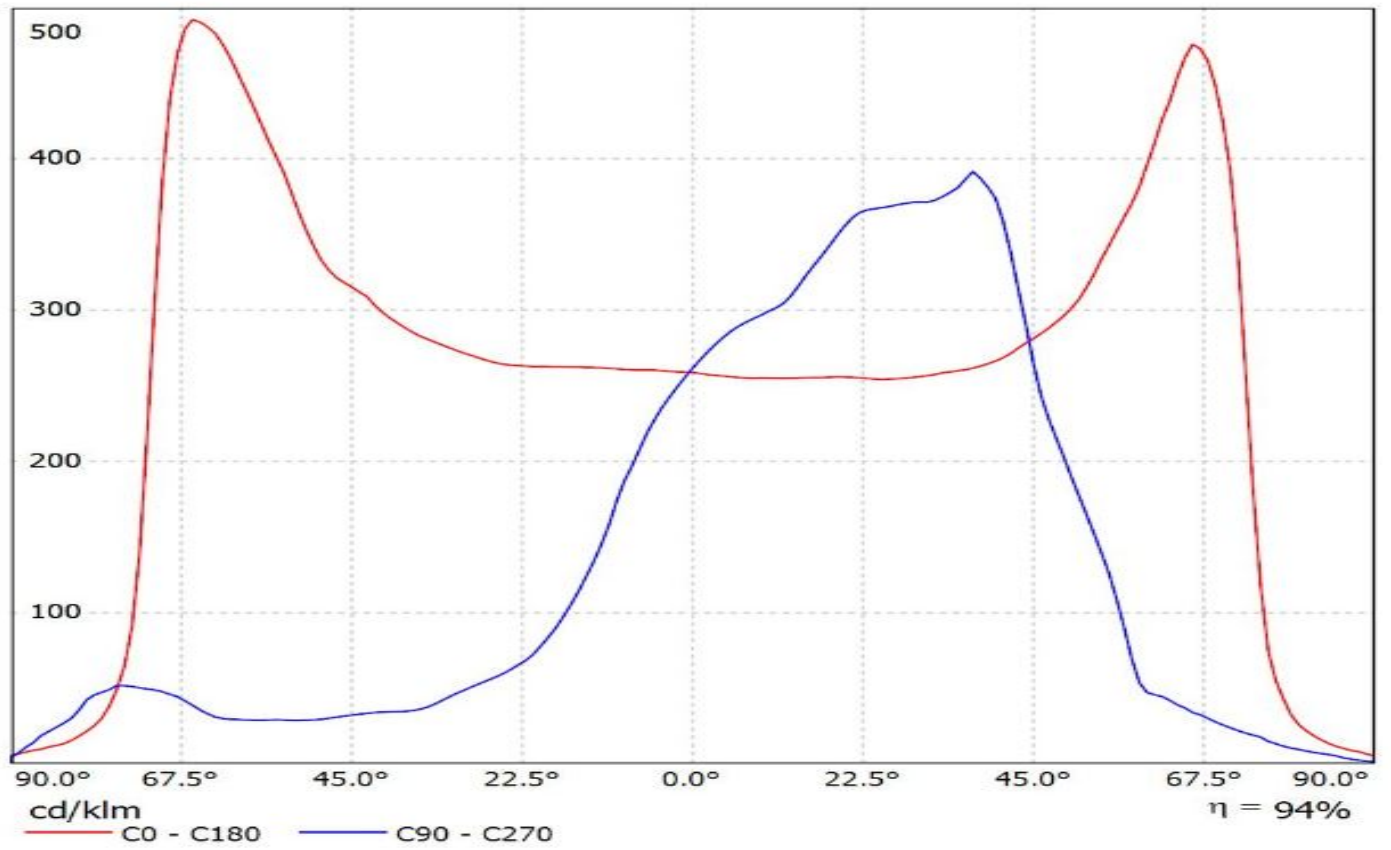

Luminaire: LEDIL OY CS12862_STRADA-IP-2X6-DWC_(XT-E) Eff.94.4%
Lamps: 1 x Cree XT-E (1188lm@250mA)

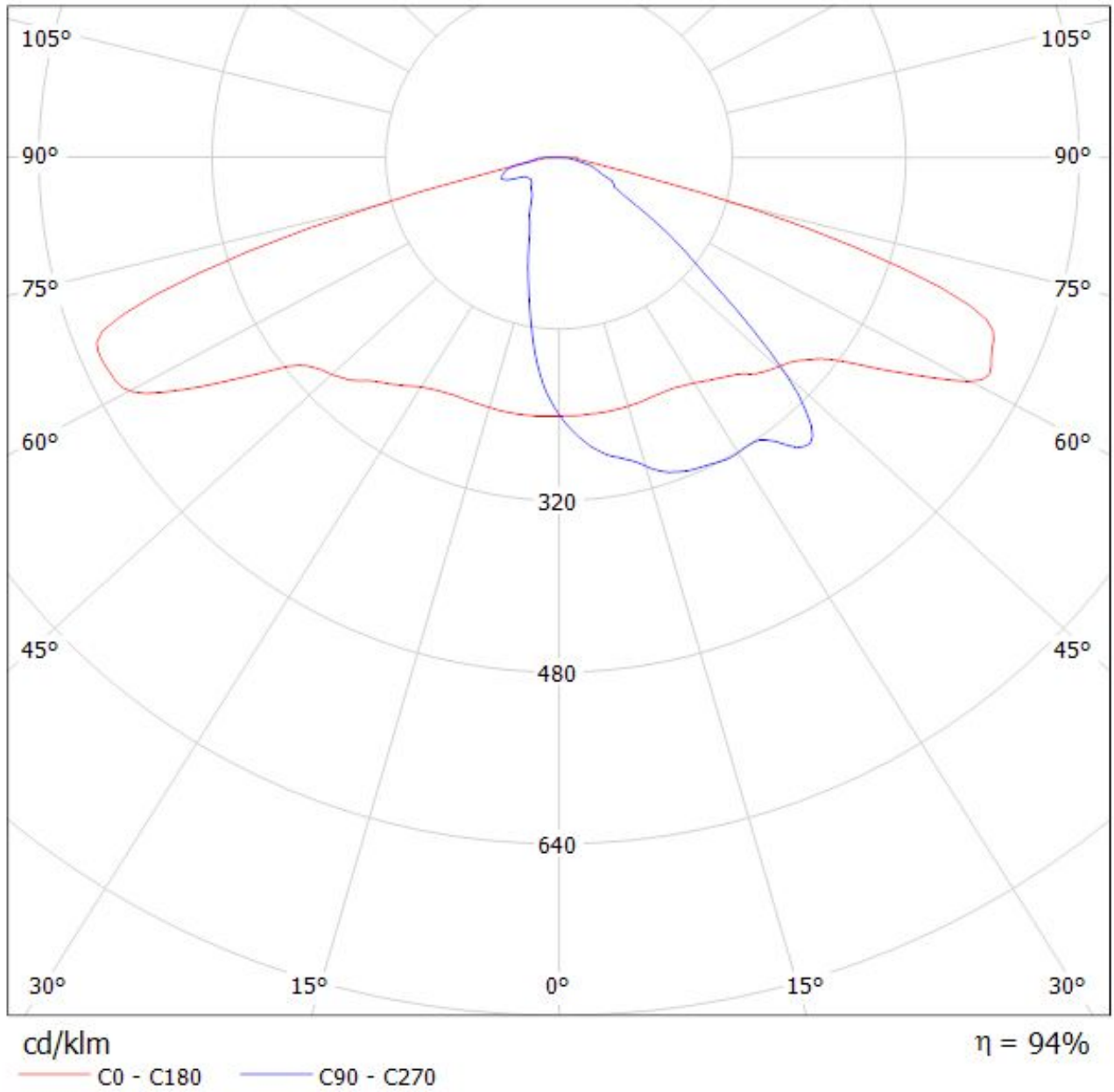

Luminaire: LEDiL Oy CS12862_STRADA-IP-2X6-DWC_(XP-G) Eff.96%
Lamps: 1 x Cree XP-G (787.883lm@250mA)

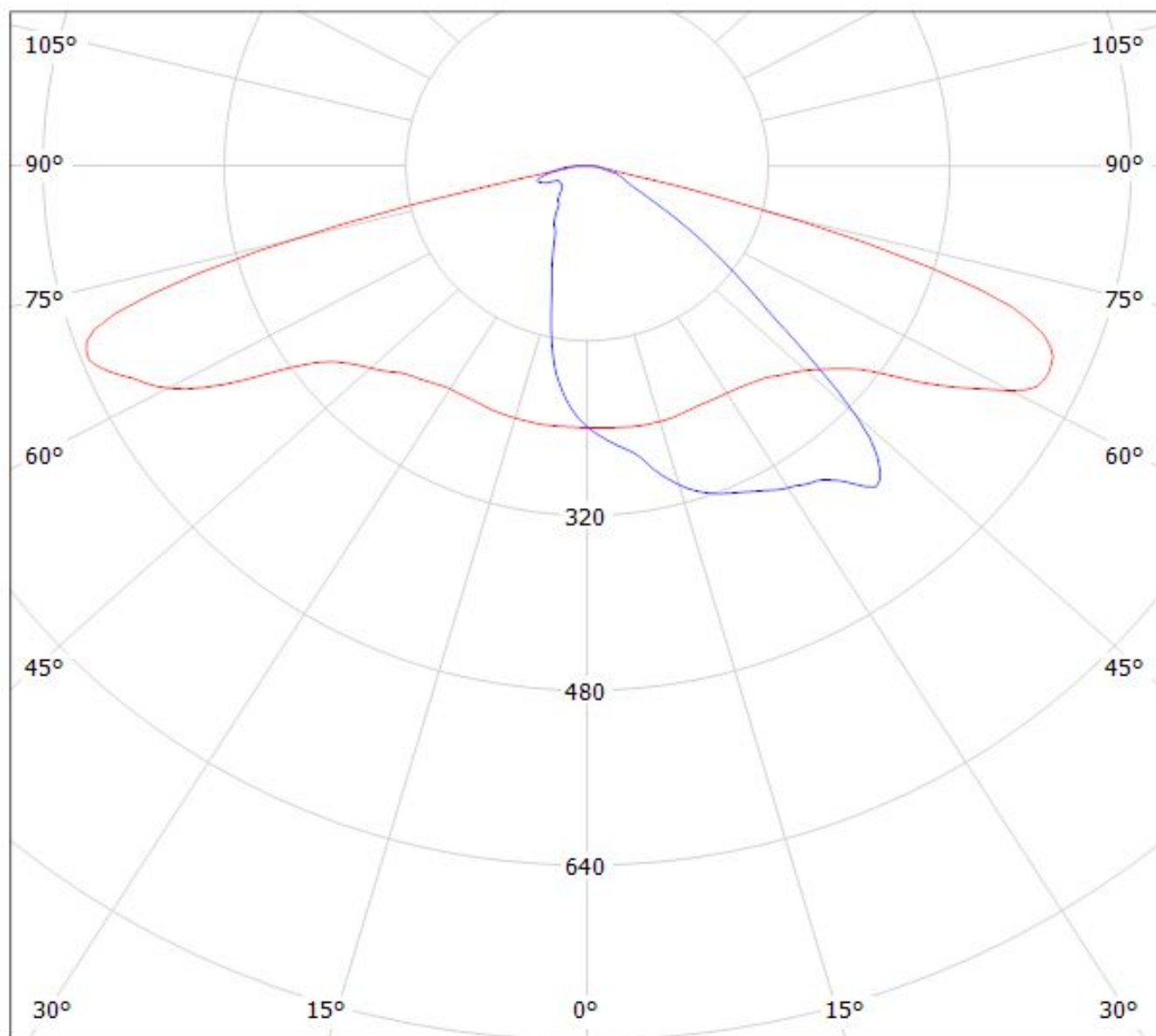

cd/klm

— C0 - C180

— C90 - C270

$\eta = 96\%$

Luminaire: LEDiL Oy CS12862_STRADA-IP-2X6-DWC_(XP-G2) Eff. 94%
Lamps: 1 x CREE_XP-G2_1303lm@250mA_P=8.58363W_I=249.8mA

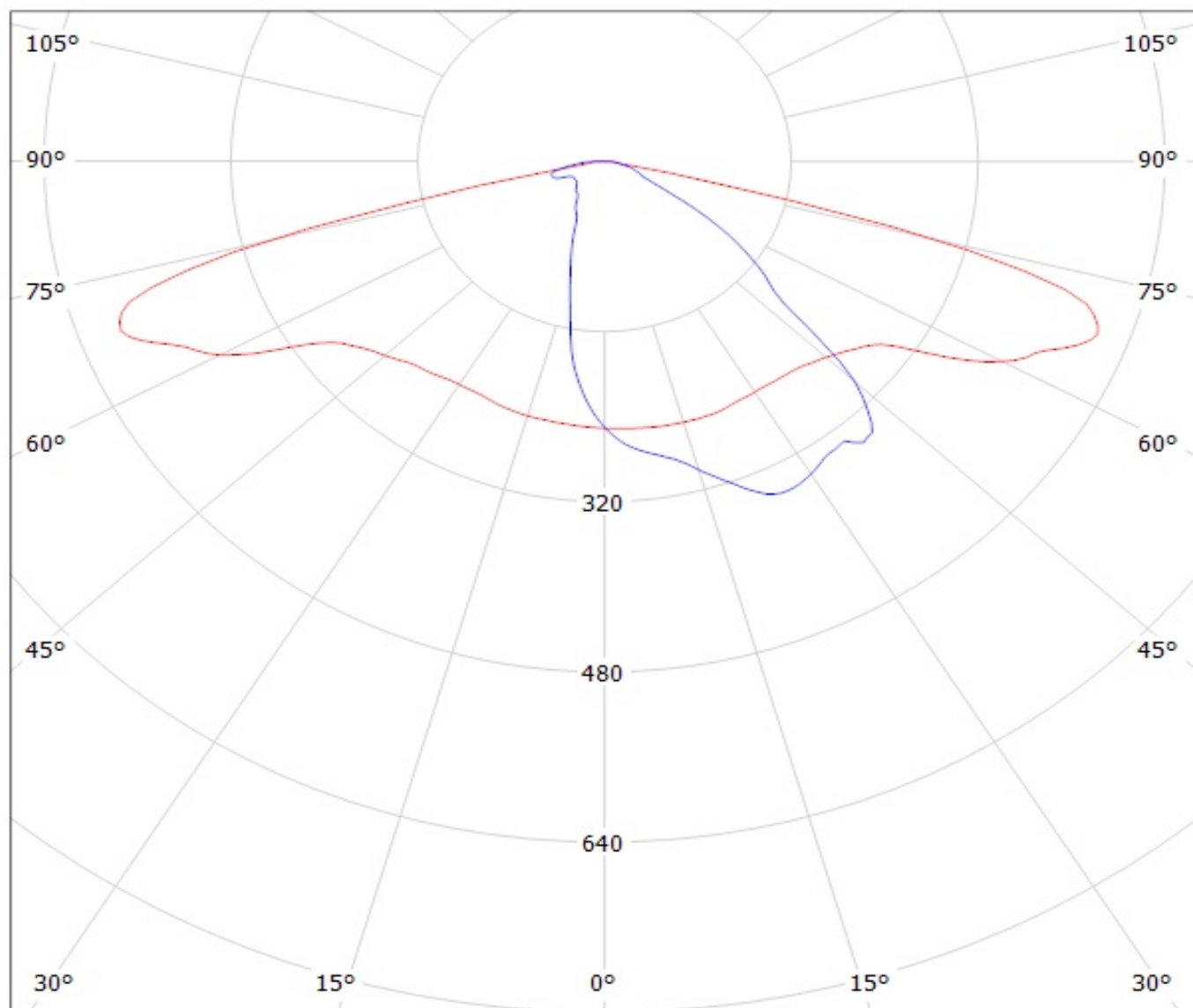

cd/klm

— C0 - C180 — C90 - C270

Luminaire: Ledil CS12862_STRADA-IP-2X6-DWC_(XP-G3)

Lamps: 1 x Cree_XP-G3_6x2_(XPGDWT-B1-6C1-S3-0-01)_1521.26lm@250mA_P=8.253W_I=0.25A

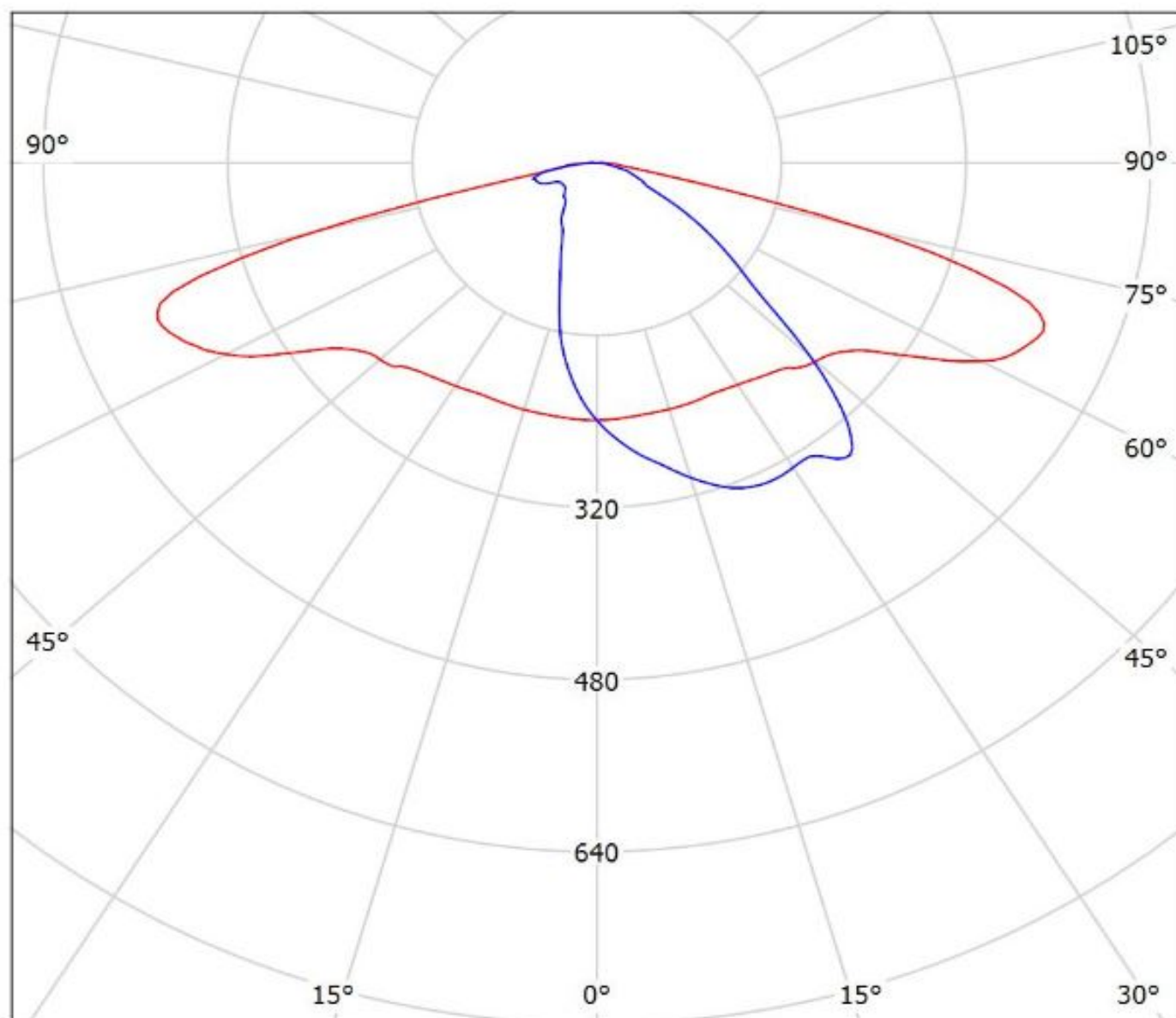

cd/klm

— C0 - C180 — C90 - C270

$\eta = 96\%$

Luminaire: Ledil CS12862_STRADA-IP-2X6-DWC_(H35C1)

Lamps: 1 x LG_H35C1_2x6_1389.53lm@250mA_CCT=5700_P=8.59425W_I=0.250A

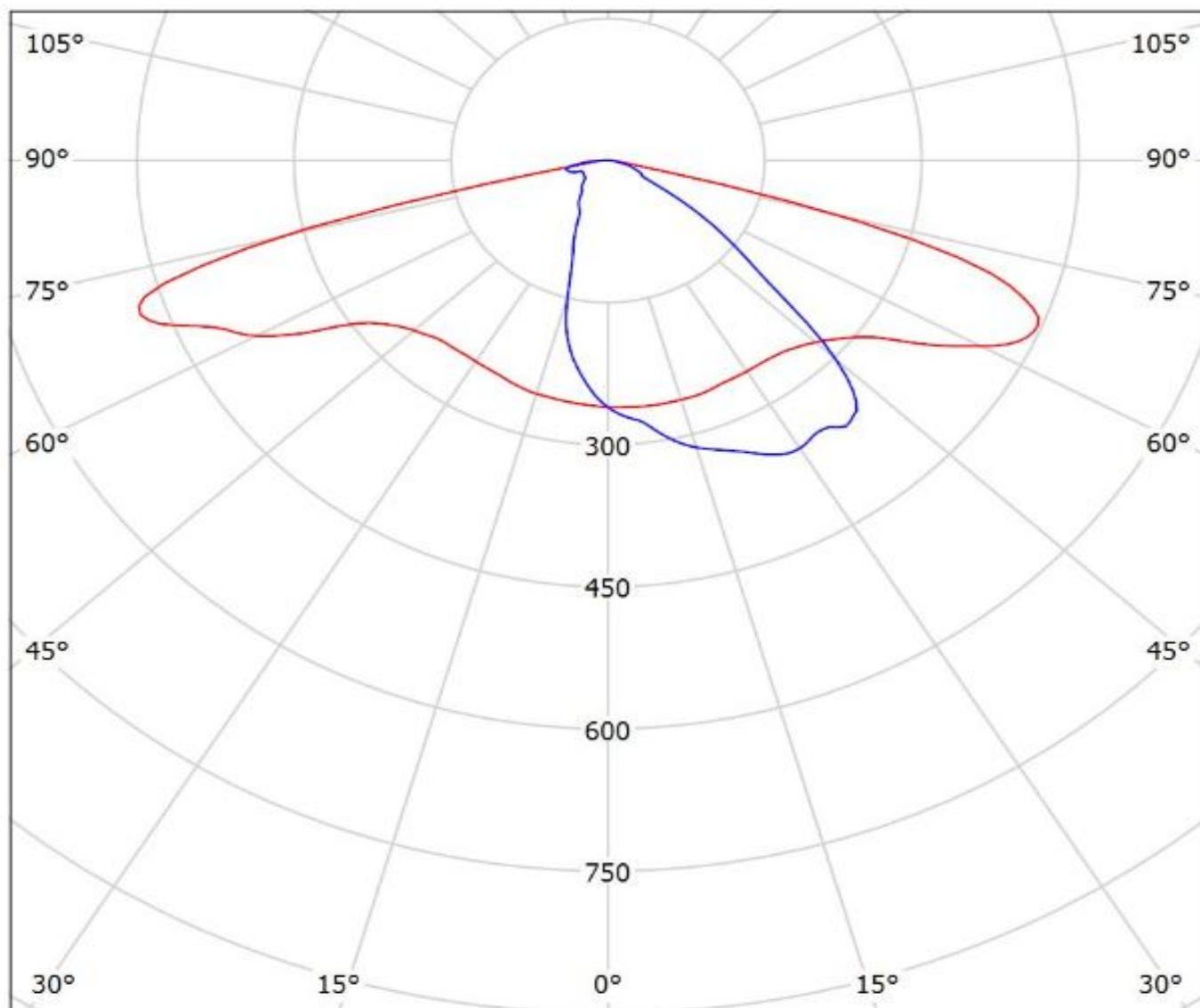

cd/klm

— C0 - C180 — C90 - C270

$\eta = 95\%$

Luminaire: LEDiL Oy CS12862_STRADA-IP-2X6-DWC_(Luxeon_T)_3
Lamps: 1 x Luxeon T 2x6 (LXH8-FW30) 1044.17lm@250mA P=8.46372W I=0.2498A

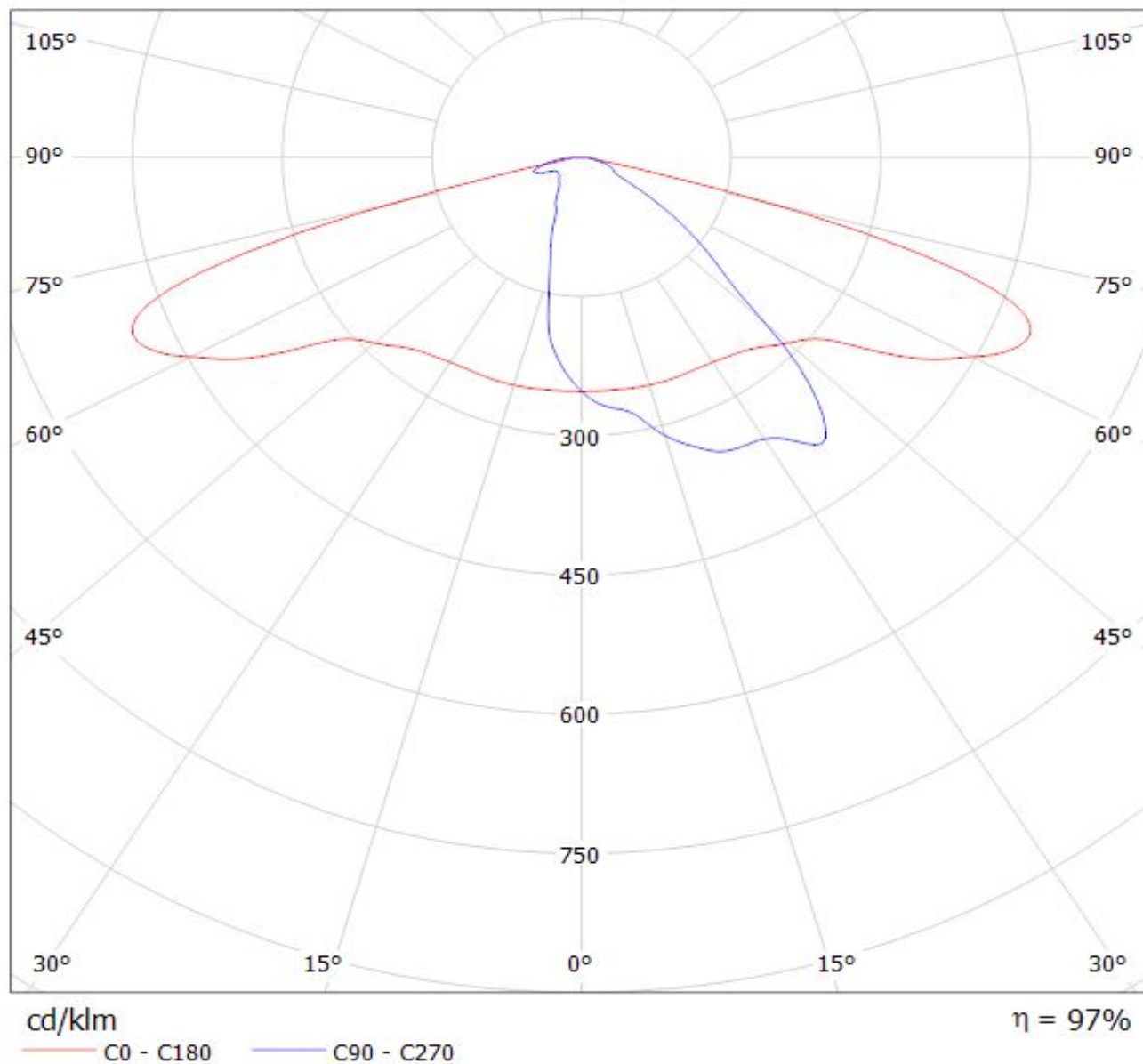

Luminaire: Ledil CS12862_STRADA-IP-2X6-DWC_(NVSL219CT)

Lamps: 1 x Nichia_NVSL219CT_2x6_1262.53lm@250mA_P=8.35825W_I=0.25A

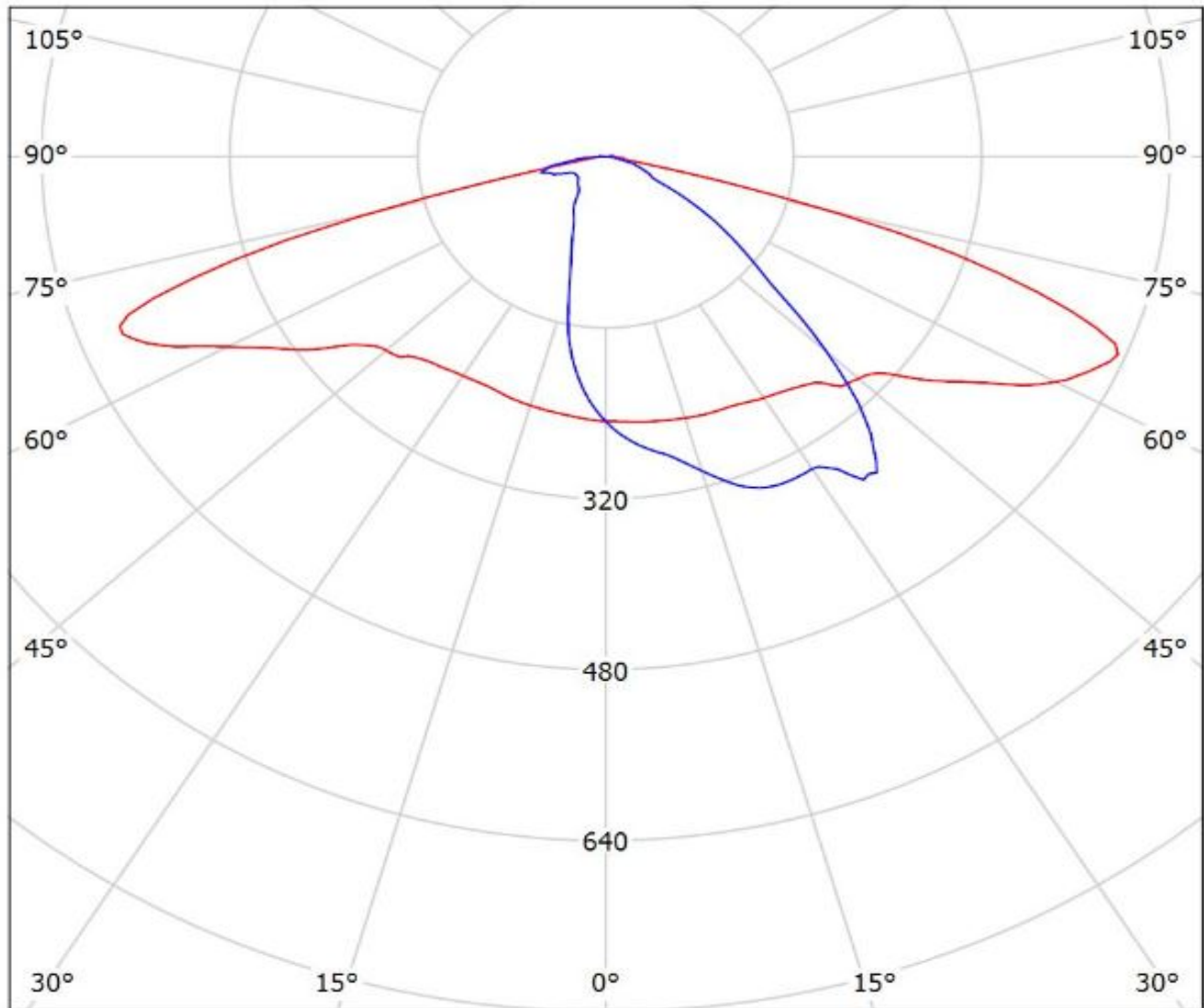

cd/klm

— C0 - C180

— C90 - C270

$\eta = 96\%$

Luminaire: LEDiL Oy CS12862_STRADA-IP-2X6-DWC_(SQ-PC) Eff.96%
Lamps: 1 x Oslon SQ PC (1173.81lm@250mA)

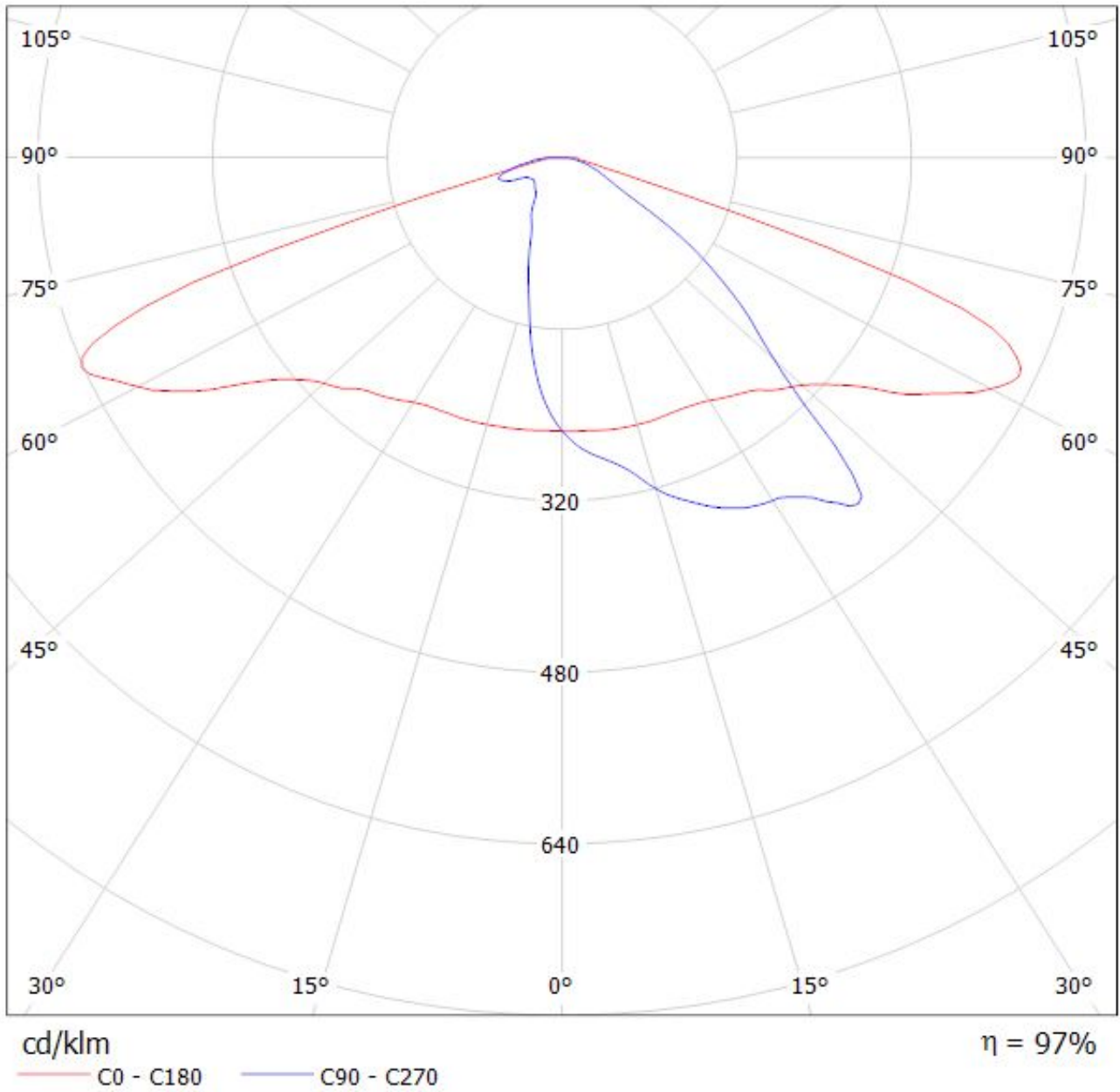

Luminaire: Ledil Oy CS12862_STRADA-IP-2X6-DWC_(Duris_P8)_SIMULATED
Lamps: 1 x Osram Duris P8

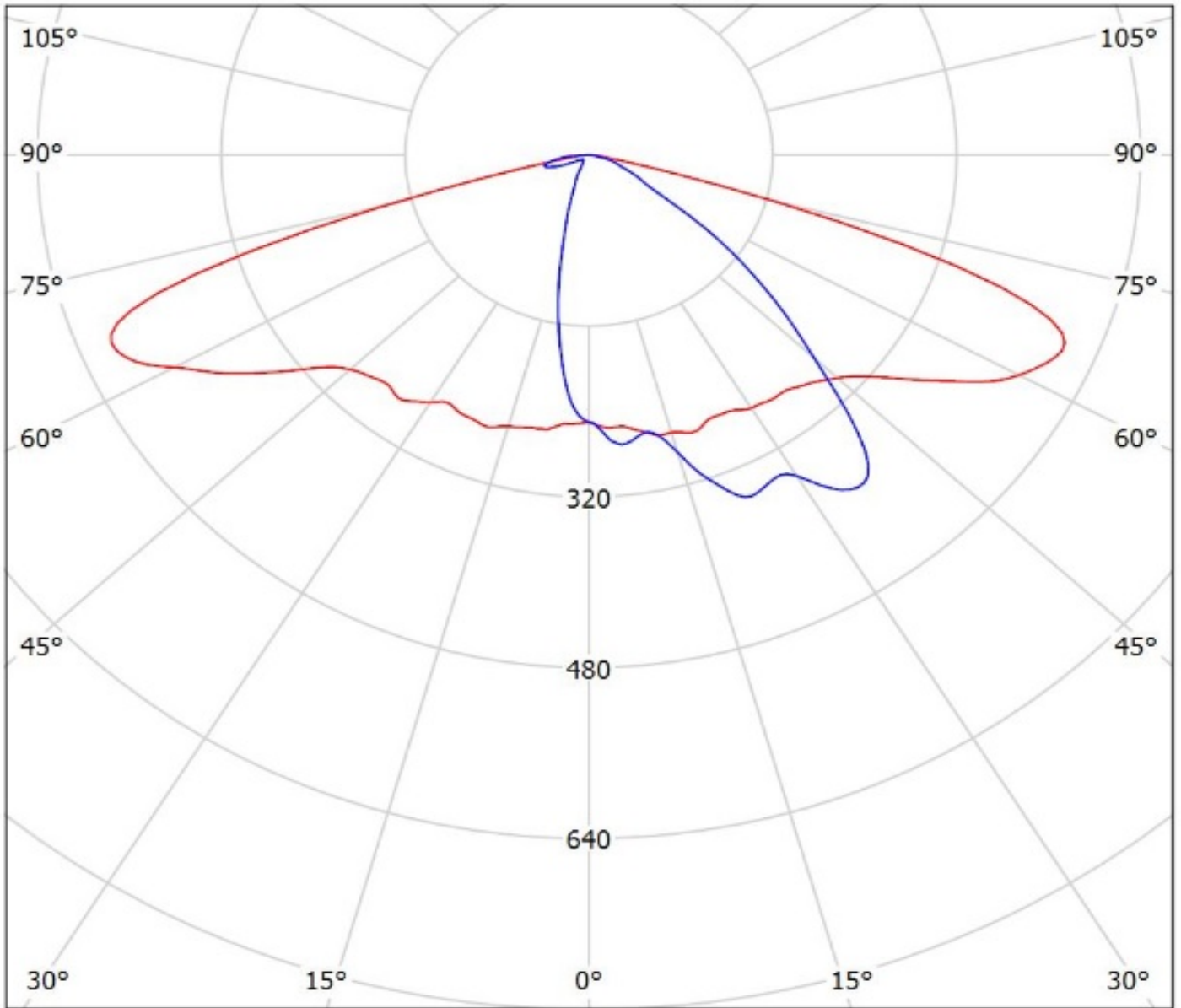

cd/klm

— C0 - C180 — C90 - C270

$\eta = 90\%$

Luminaire: LEDiL Oy CS12862_STRADA-IP-2X6-DWC_(LH351Z)
Lamps: 1 x SAMSUNG_LH351Z_2x6_958.45lm@250mA_P=8.67003W_I=249.9mA

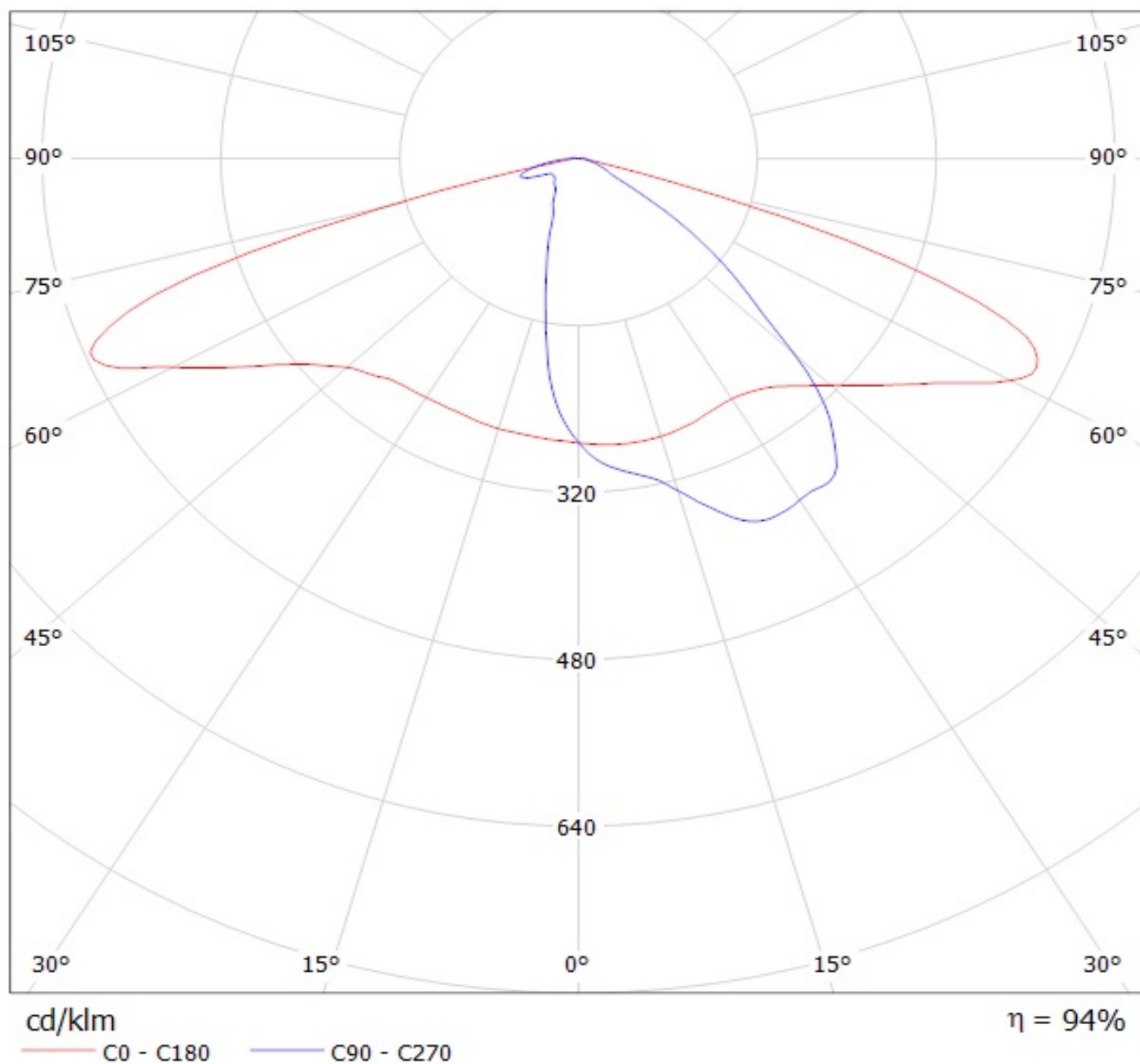

Ledil Oy CS12862_STRADA-IP-2X6-DWC-Seoul-Z5M_SIMULATED / LDC (Polar)

Luminaire: Ledil Oy CS12862_STRADA-IP-2X6-DWC-Seoul-Z5M_SIMULATED
Lamps: 1 x Seoul Z5M

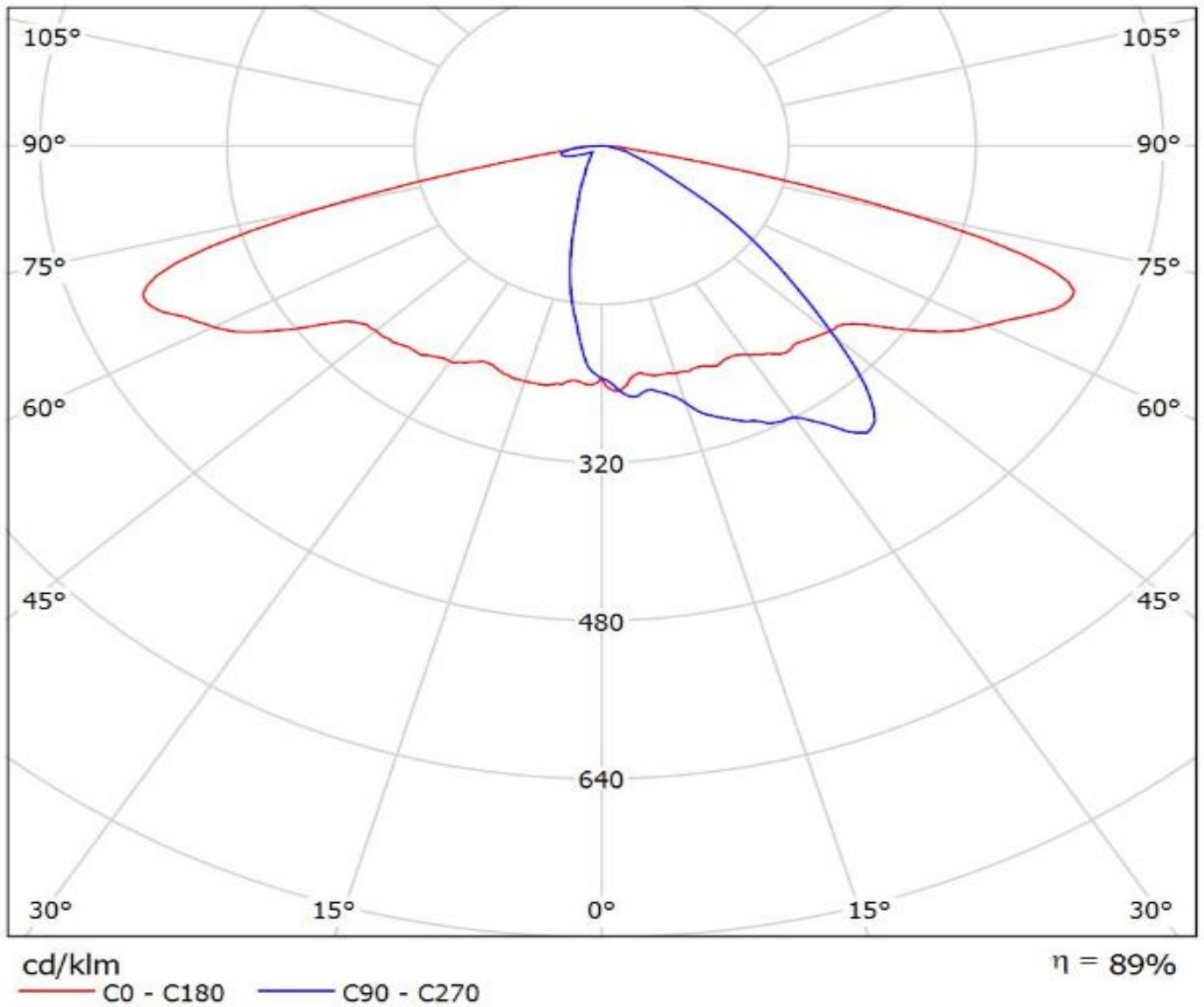

Luminaire: Ledil Oy CS12862_STRADA-IP-2X6-DWC_(Z5M1)_SIMULATED

Lamps: 1 x Seoul Z5M1

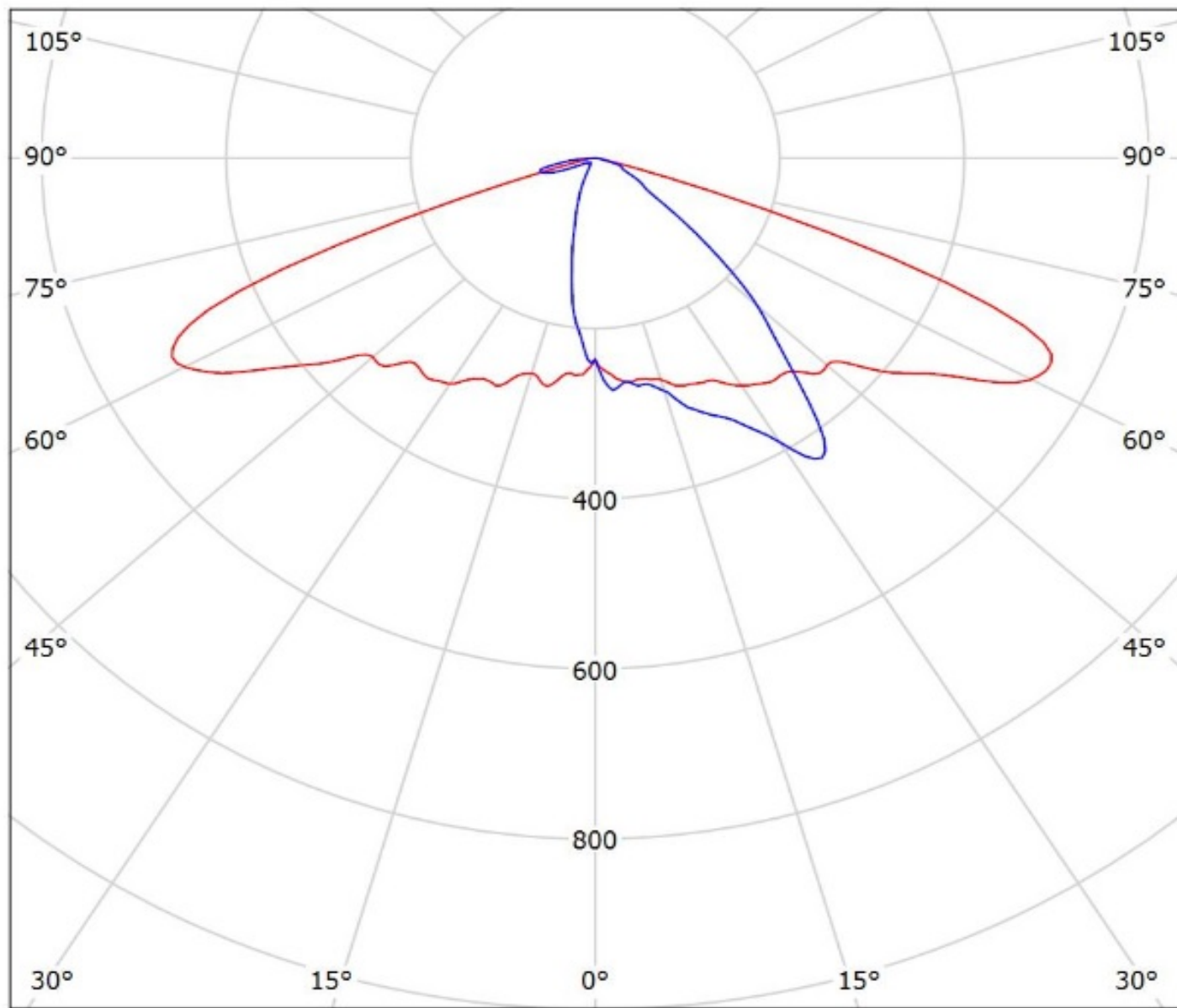

cd/klm

— C0 - C180 — C90 - C270

η = 90%

Luminaire: Ledil CS12862_STRADA-IP-2X6-DWC_(Z8Y22_PLUS)

Lamps: 1 x Seoul_Z8Y22_PLUS_2X6_(SZ8-Y22-W0-C7P)1489.65lm@250mA_P=8.30675W_I=0.250A

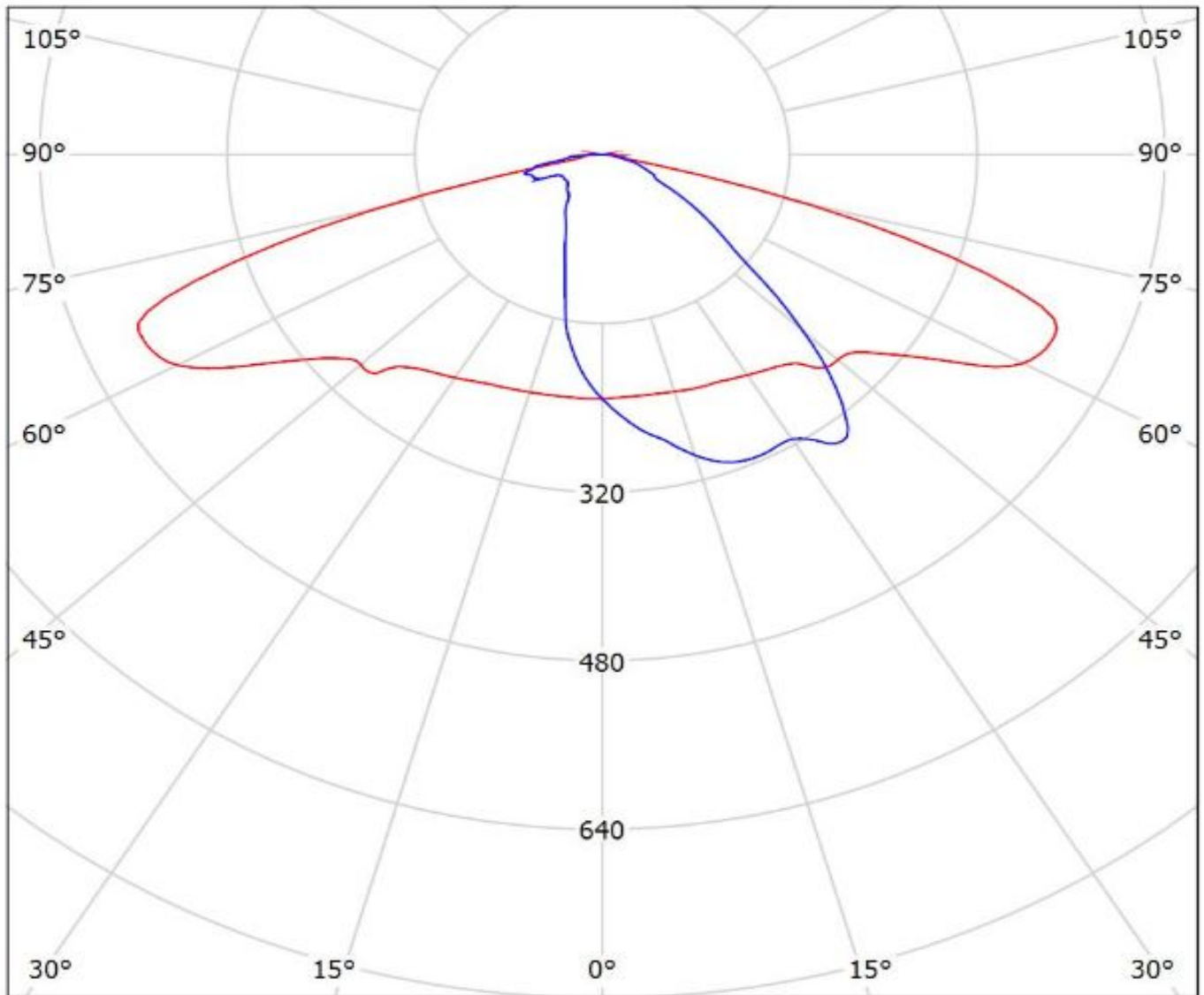

cd/klm

— C0 - C180

— C90 - C270

η = 96%

Ledil CS12862_STRADA-IP-2X6-DWC_(TL1L4) / LDC (Polar)

Luminaire: Ledil CS12862_STRADA-IP-2X6-DWC_(TL1L4)

Lamps: 1 x Toshiba_TL1L4_2x6_(TL1L4-DW0)_1346.96lm@250mA_CCT=6500K_P=8.5W_I=0.25A

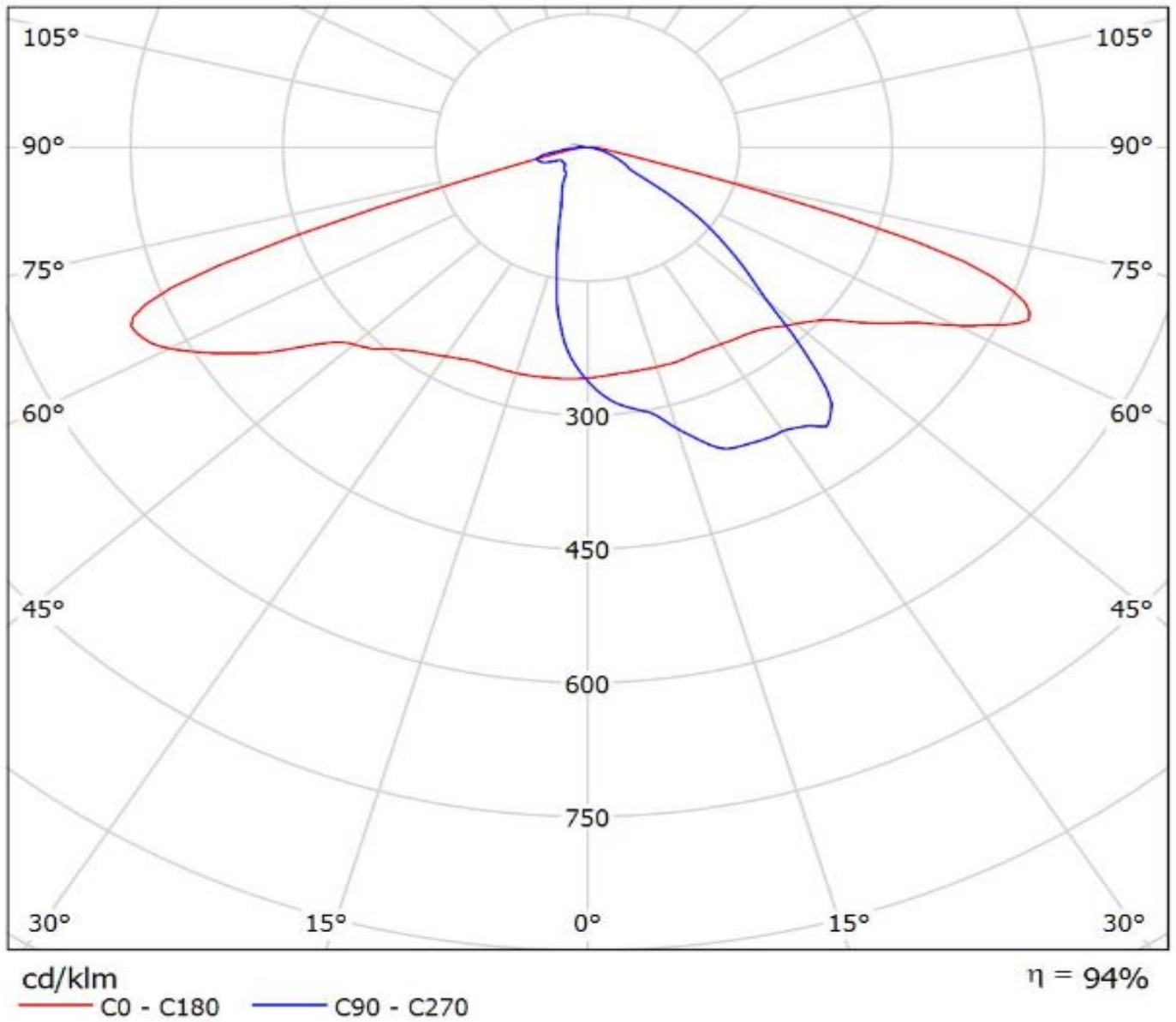

NOTE: The typical divergence will be changed by different color, chip size and chip position tolerance. The typical total divergence is the full angle measured where the luminous intensity is half of the peak value.