

Ultrafast recovery diode

Main product characteristics

$I_{F(AV)}$	15 A
V_{RRM}	200 V
$T_j(\text{max})$	175° C
$V_F(\text{typ})$	0.85 V
$t_{rr}(\text{typ})$	20 ns

Features and benefits

- Very low conduction losses
- Negligible switching losses
- Low forward and reverse recovery time
- High junction temperature
- Insulated packages
 - TO-220FPAC
Electrical insulation 2000 V_{DC}
 - TO-220AC Ins
Electrical insulation 2500 V_{RMS}

Description

The STTH1502 uses ST's new 200V planar Pt doping technology, and is specially suited for switching mode base drive and transistor circuits.

Packaged in TO-220AC, TO-220FPAC, and TO-220 Ins, this device is intended for use in low voltage, high frequency inverters, free wheeling and polarity protection.

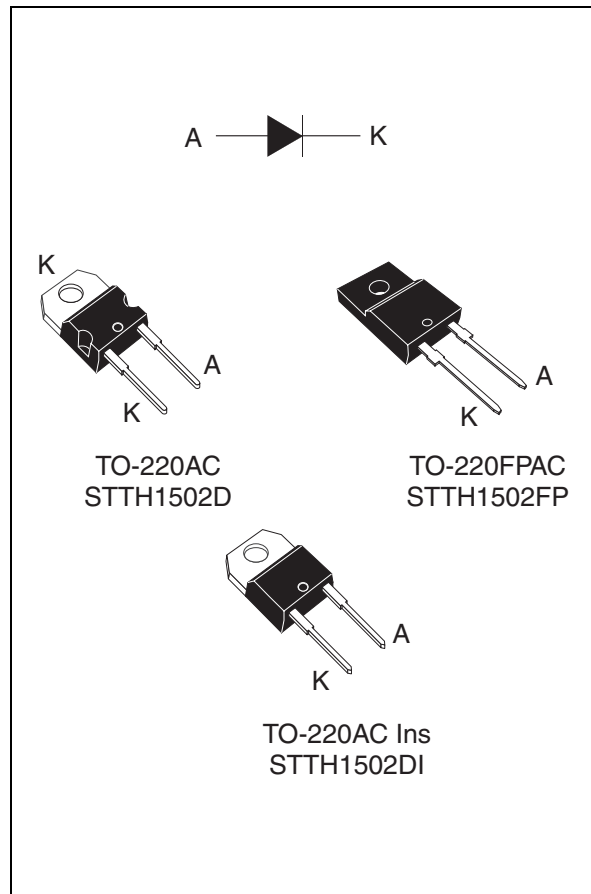

Order codes

Part Number	Marking
STTH1502D	STTH1502
STTH1502FP	STTH1502
STTH1502DI	STTH1502DI

1 Characteristics

Table 1. Absolute ratings (limiting values at $T_j = 25^\circ\text{C}$, unless otherwise specified)

Symbol	Parameter		Value	Unit	
V_{RRM}	Repetitive peak reverse voltage		200	V	
$I_{F(RMS)}$	RMS forward current		32	A	
$I_{F(AV)}$	Average forward current, $\delta = 0.5$	TO-220AC	$T_c = 130^\circ\text{C}$	15	A
		TO-220AC Ins	$T_c = 105^\circ\text{C}$		
		TO-220FPAC	$T_c = 85^\circ\text{C}$		
I_{FSM}	Surge non repetitive forward current	$t_p = 10\text{ ms Sinusoidal}$	150	A	
T_{stg}	Storage temperature range		-65 to + 175	$^\circ\text{C}$	
T_j	Maximum operating junction temperature		175	$^\circ\text{C}$	

Table 2. Thermal parameters

Symbol	Parameter		Value	Unit
$R_{th(j-c)}$	Junction to case	TO-220AC	2.5	$^\circ\text{C/W}$
		TO-220AC Ins	3.8	
		TO-220FPAC	5	

Table 3. Static electrical characteristics

Symbol	Parameter	Test conditions		Min.	Typ	Max.	Unit
$I_R^{(1)}$	Reverse leakage current	$T_j = 25^\circ\text{C}$	$V_R = V_{RRM}$			10	μA
		$T_j = 125^\circ\text{C}$			10	100	
$V_F^{(2)}$	Forward voltage drop	$T_j = 25^\circ\text{C}$	$I_F = 15\text{ A}$		1	1.1	V
		$T_j = 150^\circ\text{C}$			0.85	0.95	
		$T_j = 125^\circ\text{C}$	$I_F = 30\text{ A}$		1.05	1.20	
		$T_j = 25^\circ\text{C}$			1.15	1.3	
		$T_j = 150^\circ\text{C}$			1	1.15	

1. Pulse test: $t_p = 5\text{ ms}$, $\delta < 2\%$

2. Pulse test: $t_p = 380\text{ }\mu\text{s}$, $\delta < 2\%$

To evaluate the conduction losses use the following equation:

$$P = 0.74 \times I_{F(AV)} + 0.014 I_{F(RMS)}^2$$

Table 4. Dynamic characteristics

Symbol	Parameter	Test conditions	Min.	Typ	Max.	Unit
t_{rr}	Reverse recovery time	$I_F = 1\text{ A}$, $di_F/dt = -50\text{ A}/\mu\text{s}$, $V_R = 30\text{ V}$, $T_j = 25^\circ\text{ C}$		28	36	ns
		$I_F = 1\text{ A}$, $di_F/dt = -100\text{ A}/\mu\text{s}$, $V_R = 30\text{ V}$, $T_j = 25^\circ\text{ C}$		20	25	
I_{RM}	Reverse recovery current	$I_F = 15\text{ A}$, $di_F/dt = -200\text{ A}/\mu\text{s}$, $V_R = 160\text{ V}$, $T_j = 125^\circ\text{ C}$		5.7	7.2	A
t_{fr}	Forward recovery time	$I_F = 15\text{ A}$, $di_F/dt = 50\text{ A}/\mu\text{s}$ $V_{FR} = 1.1 \times V_{Fmax}$, $T_j = 25^\circ\text{ C}$		200		ns
V_{FP}	Forward recovery voltage	$I_F = 15\text{ A}$, $di_F/dt = 50\text{ A}/\mu\text{s}$, $T_j = 25^\circ\text{ C}$		1.3		V

Figure 1. Peak current versus duty cycle

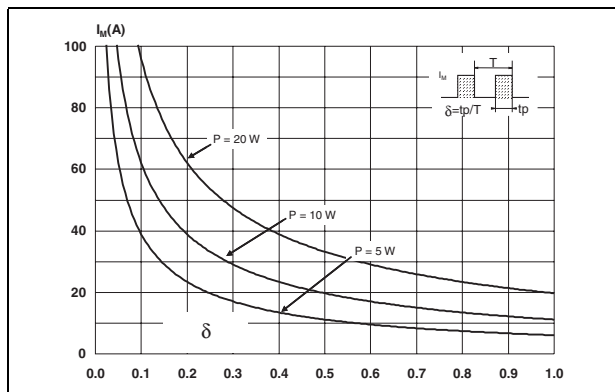

Figure 2. Forward voltage drop versus forward current (typical values)

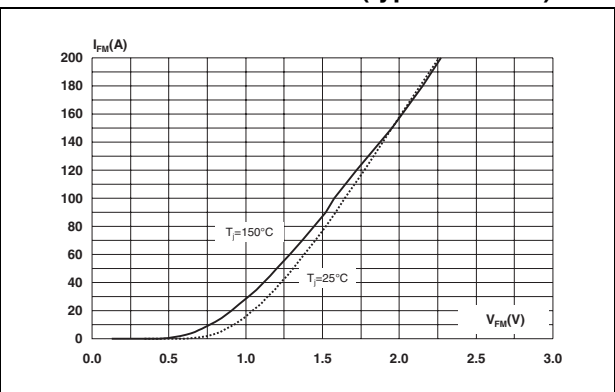

Figure 3. Forward voltage drop versus forward current (maximum values)

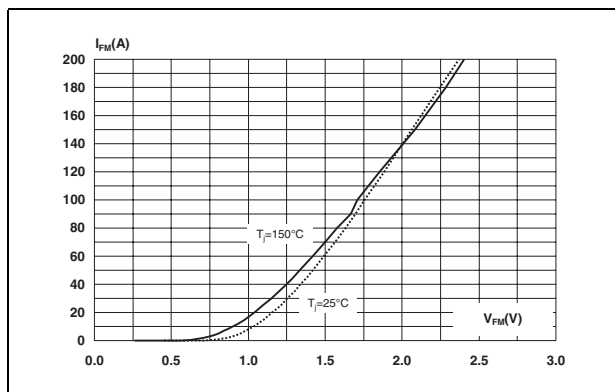

Figure 4. Relative variation of thermal impedance, junction to case, versus pulse duration (TO-220AC)

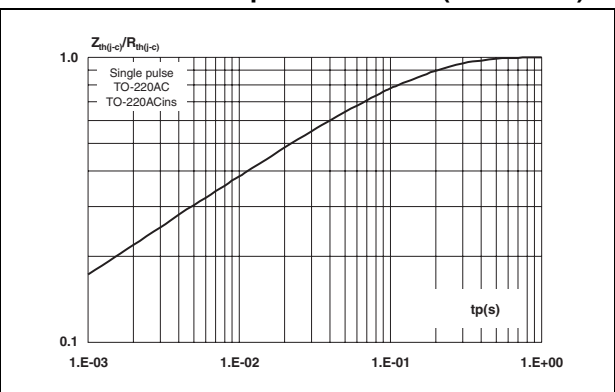

Figure 5. Relative variation of thermal impedance, junction to case, versus pulse duration (TO-220FPAC)

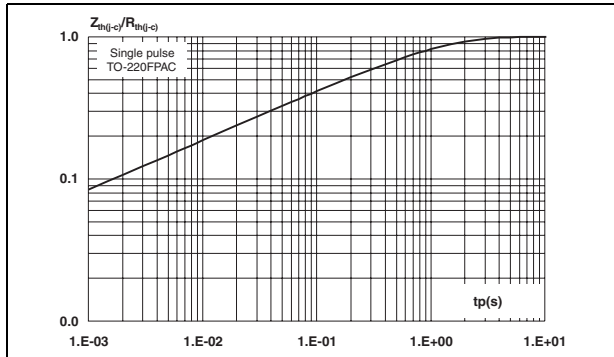

Figure 6. Junction capacitance versus reverse applied voltage (typical values)

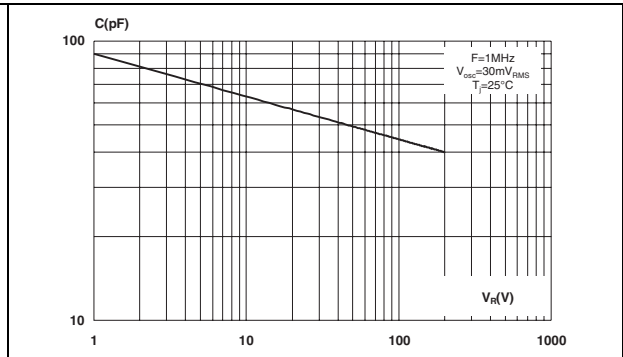

Figure 7. Reverse recovery charges versus di_F/dt (typical values)

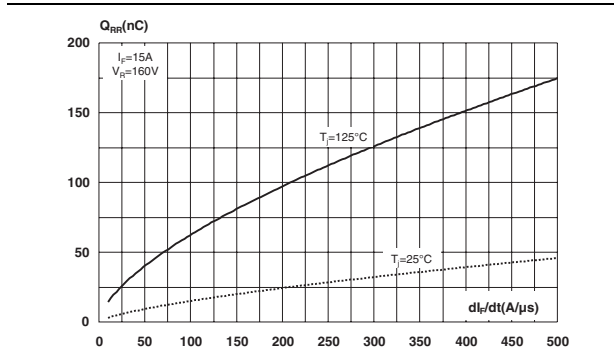

Figure 8. Reverse recovery time versus di_F/dt (typical values)

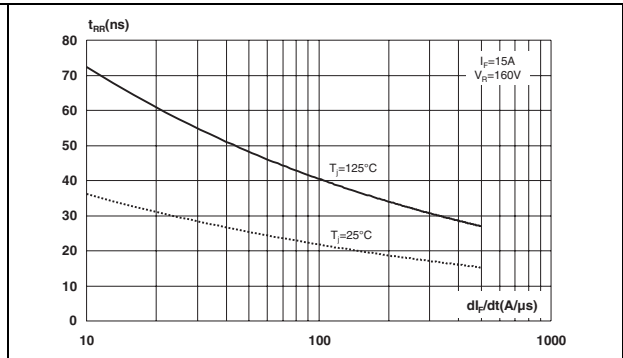

Figure 9. Peak reverse recovery current versus di_F/dt (typical values)

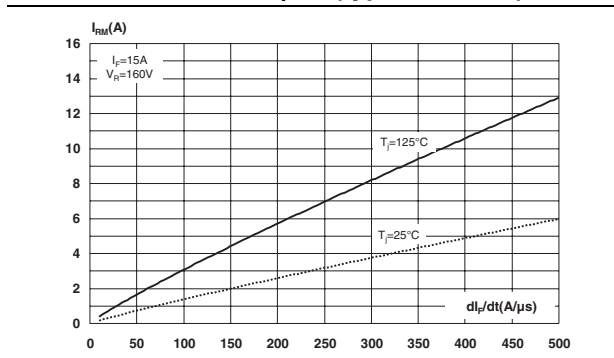
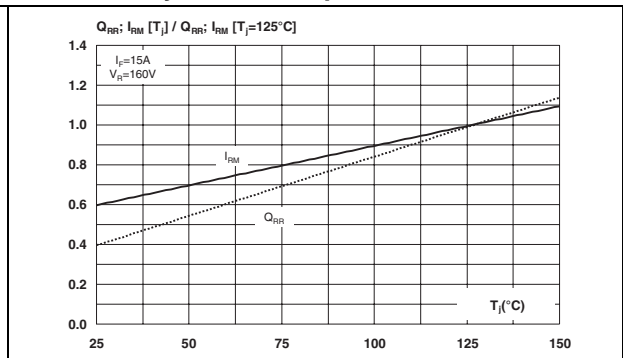
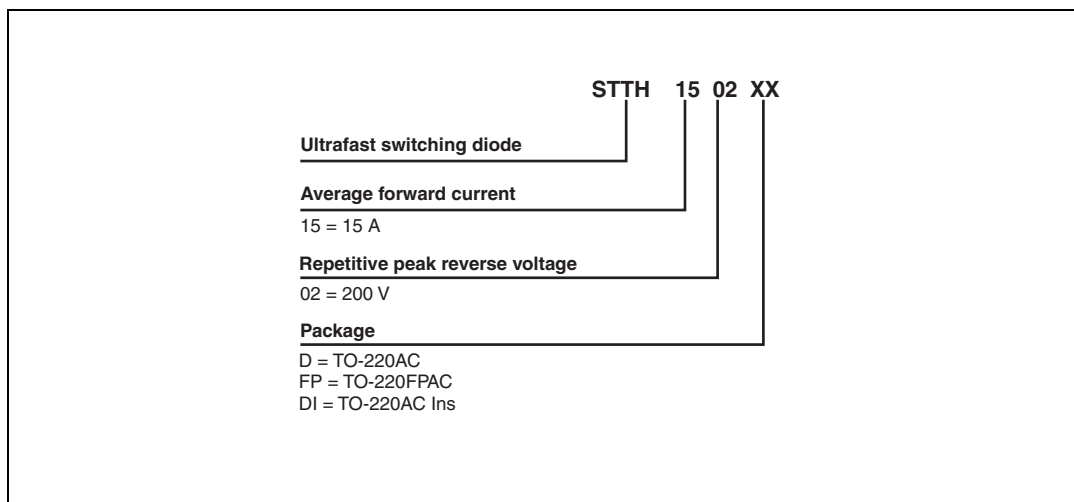

Figure 10. Dynamic parameters versus junction temperature



2 Ordering information scheme



3 Package information

Epoxy meets UL94, V0

Cooling method: by conduction (C)

Recommended torque value: 0.8 Nm

Maximum torque value: 1.0 Nm

Table 5. T0-220AC dimensions

REF.	DIMENSIONS			
	Millimeters		Inches	
	Min.	Max.	Min.	Max.
A	4.40	4.60	0.173	0.181
C	1.23	1.32	0.048	0.051
D	2.40	2.72	0.094	0.107
E	0.49	0.70	0.019	0.027
F	0.61	0.88	0.024	0.034
F1	1.14	1.70	0.044	0.066
G	4.95	5.15	0.194	0.202
H2	10.00	10.40	0.393	0.409
L2	16.40 typ.		0.645 typ.	
L4	13.00	14.00	0.511	0.551
L5	2.65	2.95	0.104	0.116
L6	15.25	15.75	0.600	0.620
L7	6.20	6.60	0.244	0.259
L9	3.50	3.93	0.137	0.154
M	2.6 typ.		0.102 typ.	
Diam. I	3.75	3.85	0.147	0.151

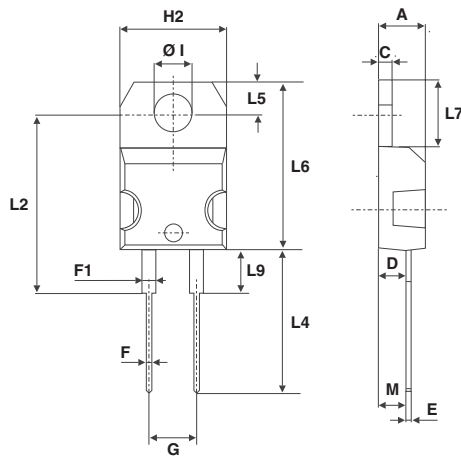
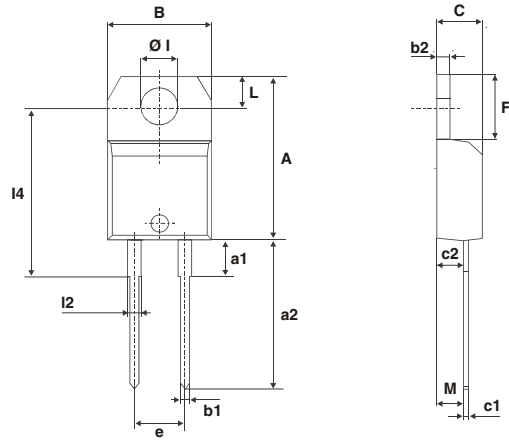

Table 6. T0-220FPAC dimensions

REF	DIMENSIONS			
	Millimeters		Inches	
	Min.	Max.	Min.	Max.
A	4.4	4.6	0.173	0.181
B	2.5	2.7	0.098	0.106
D	2.5	2.75	0.098	0.108
E	0.45	0.70	0.018	0.027
F	0.75	1	0.030	0.039
F1	1.15	1.70	0.045	0.067
G	4.95	5.20	0.195	0.205
G1	2.4	2.7	0.094	0.106
H	10	10.4	0.393	0.409
L2	16 Typ.		0.63 Typ.	
L3	28.6	30.6	1.126	1.205
L4	9.8	10.6	0.386	0.417
L5	2.9	3.6	0.114	0.142
L6	15.9	16.4	0.626	0.646
L7	9.00	9.30	0.354	0.366
Dia.	3.00	3.20	0.118	0.126

Table 7. TO-220AC Ins. dimensions



Ref.	Dimensions					
	Millimeters			Inches		
	Min.	Typ.	Max.	Min.	Typ.	Max.
A	15.20		15.90	0.598		0.625
a1		3.75			0.147	
a2	13.00		14.00	0.511		0.551
B	10.00		10.40	0.393		0.409
b1	0.61		0.88	0.024		0.034
b2	1.23		1.32	0.048		0.051
C	4.40		4.60	0.173		0.181
c1	0.49		0.70	0.019		0.027
c2	2.40		2.72	0.094		0.107
e	4.80		5.40	0.189		0.212
F	6.20		6.60	0.244		0.259
Ø1	3.75		3.85	0.147		0.151
I4	15.80	16.40	16.80	0.622	0.646	0.661
L	2.65		2.95	0.104		0.116
I2	1.14		1.70	0.044		0.066
M		2.60			0.102	

In order to meet environmental requirements, ST offers these devices in ECOPACK® packages. These packages have a lead-free second level interconnect. The category of second level interconnect is marked on the package and on the inner box label, in compliance with JEDEC Standard JESD97. The maximum ratings related to soldering conditions are also marked on the inner box label. ECOPACK is an ST trademark. ECOPACK specifications are available at: www.st.com.

4 Ordering information

Part Number	Marking	Package	Weight	Base qty	Delivery mode
STTH1502D	STTH1502	TO-220AC	1.86 g	50	Tube
STTH1502FP	STTH1502	TO-220FPAC	2.2 g	50	Tube
STTH1502DI	STTH1502DI	TO-220AC Ins	1.86	50	Tube

5 Revision history

Date	Revision	Description of Changes
05-Apr-2006	1	First issue
10-Oct-2006	2	Added TO-220AC Ins package

Please Read Carefully:

Information in this document is provided solely in connection with ST products. STMicroelectronics NV and its subsidiaries ("ST") reserve the right to make changes, corrections, modifications or improvements, to this document, and the products and services described herein at any time, without notice.

All ST products are sold pursuant to ST's terms and conditions of sale.

Purchasers are solely responsible for the choice, selection and use of the ST products and services described herein, and ST assumes no liability whatsoever relating to the choice, selection or use of the ST products and services described herein.

No license, express or implied, by estoppel or otherwise, to any intellectual property rights is granted under this document. If any part of this document refers to any third party products or services it shall not be deemed a license grant by ST for the use of such third party products or services, or any intellectual property contained therein or considered as a warranty covering the use in any manner whatsoever of such third party products or services or any intellectual property contained therein.

UNLESS OTHERWISE SET FORTH IN ST'S TERMS AND CONDITIONS OF SALE ST DISCLAIMS ANY EXPRESS OR IMPLIED WARRANTY WITH RESPECT TO THE USE AND/OR SALE OF ST PRODUCTS INCLUDING WITHOUT LIMITATION IMPLIED WARRANTIES OF MERCHANTABILITY, FITNESS FOR A PARTICULAR PURPOSE (AND THEIR EQUIVALENTS UNDER THE LAWS OF ANY JURISDICTION), OR INFRINGEMENT OF ANY PATENT, COPYRIGHT OR OTHER INTELLECTUAL PROPERTY RIGHT.

UNLESS EXPRESSLY APPROVED IN WRITING BY AN AUTHORIZED ST REPRESENTATIVE, ST PRODUCTS ARE NOT RECOMMENDED, AUTHORIZED OR WARRANTED FOR USE IN MILITARY, AIR CRAFT, SPACE, LIFE SAVING, OR LIFE SUSTAINING APPLICATIONS, NOR IN PRODUCTS OR SYSTEMS WHERE FAILURE OR MALFUNCTION MAY RESULT IN PERSONAL INJURY, DEATH, OR SEVERE PROPERTY OR ENVIRONMENTAL DAMAGE. ST PRODUCTS WHICH ARE NOT SPECIFIED AS "AUTOMOTIVE GRADE" MAY ONLY BE USED IN AUTOMOTIVE APPLICATIONS AT USER'S OWN RISK.

Resale of ST products with provisions different from the statements and/or technical features set forth in this document shall immediately void any warranty granted by ST for the ST product or service described herein and shall not create or extend in any manner whatsoever, any liability of ST.

ST and the ST logo are trademarks or registered trademarks of ST in various countries.

Information in this document supersedes and replaces all information previously supplied.

The ST logo is a registered trademark of STMicroelectronics. All other names are the property of their respective owners.

© 2006 STMicroelectronics - All rights reserved

STMicroelectronics group of companies

Australia - Belgium - Brazil - Canada - China - Czech Republic - Finland - France - Germany - Hong Kong - India - Israel - Italy - Japan - Malaysia - Malta - Morocco - Singapore - Spain - Sweden - Switzerland - United Kingdom - United States of America

www.st.com

Mouser Electronics

Authorized Distributor

Click to View Pricing, Inventory, Delivery & Lifecycle Information:

[STMicroelectronics:](#)

[STTH1502D](#) [STTH1502FP](#) [STTH1502DI](#)