

## Interactive Catalog Supplements Catalog PDFs

If you need detailed product information, or help choosing the right product for your application, see our [Interactive Catalog](#). Use the [Interactive Catalog](#) to access the most complete and up-to-date information available.

The [Interactive Catalog](#) provides an extensive collection of product specifications, application data, and technical literature that can be searched based on criteria you select.

This PDF catalog information was published in November 2000.



Sensing and Control  
[Interactive Catalog...](#)

**Click this icon to try  
the Interactive Catalog.**

---

### Sensing and Control

Honeywell Inc.

11 West Spring Street

Freeport, IL 61032

[www.honeywell.com/sensing](http://www.honeywell.com/sensing)

<b>AML21G</b>	Rect. 2 Lamp Ckts.
<b>Full Guard Bezel:</b>	
<b>AML21H</b>	Square Non-Lighted
<b>AML21J</b>	Square 1 Lamp Ckt.
<b>AML21K</b>	Rect. Non-Lighted
<b>AML21L</b>	Rect. 1 Lamp Ckt.
<b>AML21M</b>	Rect. 2 Lamp Ckts.

--

<b>D</b> 6 V Lamp*
<b>C</b> 14 V Lamp*
<b>E</b> 28 V Lamp*

<b>3</b> .025 × .025 (Printed Ckt. or Push-On)
---

	Alt. Action <b>AB</b> 1-Pole <b>AD</b> 2-Pole <b>CD</b> 4-Pole
Gold Contacts	Mom. Action <b>BA</b> 1-Pole <b>BC</b> 2-Pole <b>DC</b> 4-Pole
	Alt. Action <b>BB</b> 1-Pole <b>BD</b> 2-Pole <b>DD</b> 4-Pole
Gold-Plated Silver Contacts	Mom. Action <b>EA</b> 1-Pole <b>EC</b> 2-Pole
	Alt. Action <b>EB</b> 1-Pole <b>ED</b> 2-Pole

\* Lamps will be installed per each lamp circuit specified in the Housing Type.

Example: **AML21BBA2AA**  
 Square pushbutton switch housing non-lighted; black bezel; .110 × .020 termination; momentary action; 1-pole, double-throw; silver contacts.

<b>R</b>	V*
<b>S</b>	5V
<b>T</b>	10V
<b>W</b>	15V
<b>X</b>	24V

Protection  
for LED

Alt. Action
<b>BB</b> 1-Pole
<b>BD</b> 2-Pole
<b>DD</b> 4-Pole

Gold-Plated Silver Contacts
-----------------------------------

Mom. Action
<b>EA</b> 1-Pole
<b>EC</b> 2-Pole

Alt. Action
<b>EB</b> 1-Pole
<b>ED</b> 2-Pole

\* See LED information for devices without current limiting resistor, page 46.

Example: **AML22CBB2AA**

Square pushbutton switch housing with one LED, black bezel; red LED (without resistor); .110 × .020 termination; momentary action, 1-pole, double-throw; silver contacts.

**CONTACT ARRANGEMENT**

1, 2 or 4 poles: Form C



\* Lamps will be installed per each lamp circuit specified in the Housing Type.

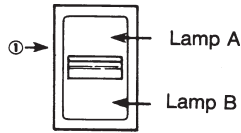

① The "MICRO SWITCH" identification is shown on this side of the switch housings.

Example: **AML23EBA2AA01**

Rectangular non-lighted paddle switch housing; black paddle and bezel; .110 × .020 terminals; with one circuit ON and one circuit OFF in each extreme operator position (maintained).

## CIRCUITRY

Silver Contacts	Gold Contacts	2-Position		3-Position			
AA	BA						
AC	BC						
(Non-illuminated switches only)							
CA	DA						
CC	DC						
(Non-illuminated switches only)							

## OPERATING ACTION

<b>2-Position:</b>			
Maint.	01 None	Maint.	
Mom.	02 None	Maint.	
Maint.	03 None	Mom.	
<b>3-Position:</b>			
Maint.	04 Maint.	Maint.	
Mom.	05 Maint.	Mom.	
Maint.	06 Maint.	Mom.	
Mom.	07 Maint.	Maint.	

\* See LED application information for devices without current-limiting resistor, page 46.

Example: **AML25FBB2AA01RX**

Rectangular paddle switch; illuminated with one red LED, this device has a black paddle and bezel, and .110 × .020 terminals; with one circuit ON and one circuit OFF in each extreme operator position (maintained).

NOTE: For further information on replacement LED's, call the 800 number.

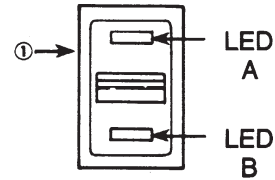
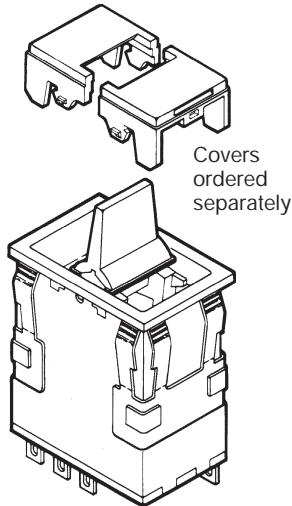

① The "MICRO SWITCH" identification is shown on this side of the switch housings.

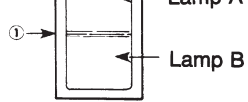

① The "MICRO SWITCH" identification is shown on this side of the switch housings.

Example: **AML24EBA2AA01**

Rectangular non-lighted rocker switch housing; black bezel; .110 × .020 terminals; with one circuit ON and one circuit OFF in each extreme operator position (maintained).

## CIRCUITRY

Silver Contacts	Gold Contacts	2-Position		3-Position			
AA	BA						
AC (Non-illuminated switches only)	BC						
CA	DA						
CC (Non-illuminated switches only)	DC						

## OPERATING ACTION

2-Position:		
Maint.	01 None	Maint.
Mom.	02 None	Maint.
Maint.	03 None	Mom.
3-Position:		
Maint.	04 Maint.	Maint.
Mom.	05 Maint.	Mom.
Maint.	06 Maint.	Mom.
Mom.	07 Maint.	Maint.

\* See LED application information for devices without current-limiting resistor, page 46.

Example: **AML26FBB2AA01RX**  
 Rectangular rocker switch; illuminated  
 with one LED, this device has a black  
 bezel, .110 × .020  
 terminals; with one  
 circuit ON and one circuit OFF in each  
 extreme operator position (maintained).

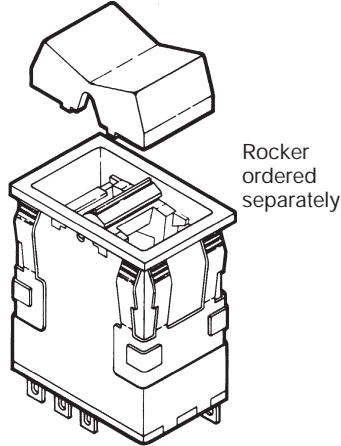
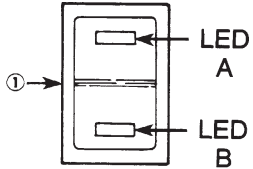

① The "MICRO SWITCH" identification is shown on this side of the switch housings.

One key per listing.

Key Combination	Key Code	Catalog Listing
BA	110	30PA101-AML
BB	109	30PA102-AML
BD	107	30PA104-AML
BE	106	30PA105-AML
BS	117	30PA117-AML
BT	118	30PA118-AML
BV	119	30PA119-AML
BW	120	30PA120-AML

⚠ Specify different Key Combinations to acquire different keys, i.e.; AML27ABK2AA21BB and AML27ABK2AA21BE have different keys. AML27ABK2AA21BB and AML27ABK3BC25BB have identical interchangeable keys.  
 Example: **AML27ABK2AC28BB**  
 Square housing; black bezel and button; .110 × .020 terminals; 2-pole double-throw; silver contacts; 3-position maintained and key code "BB".

Mom.	Maint.	Maint.
Maint.	Maint.	Maint.
Maint.	Maint.	Maint.
Maint.	Maint.	Mom.
Maint.	Maint.	Mom.

**28** and **29** operating actions should be used with Key Combinations BA and BB.

\* Key out in both positions.  
 \*\* Key out in all three positions.  
 \*\*\* Key out in center and CW positions.

† Key out in center and CCW positions.  
 †† Key out in CCW only.

### CIRCUITRY

#### 2-Position Switches:

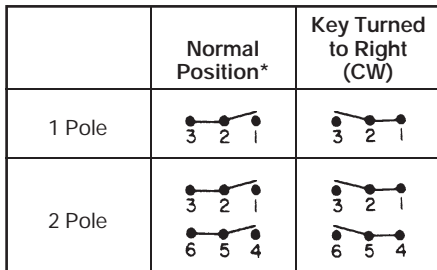

Note: These keys fit the 5-bit keylocks in the Order Guide.

#### 3-Position Switches (Available in 2-pole only.)

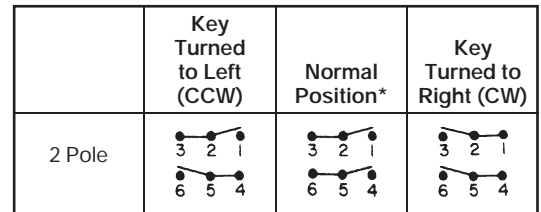

\* Circuit remains the same with key in or out.