

CDBQC0240L-HF

High-Reliability and High-Performance

$I_o = 200\text{ mA}$
 $V_R = 40\text{ Volts}$
RoHS Device
Halogen Free

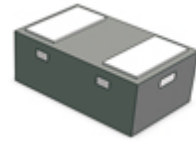

Features

- Low forward voltage.
- Designed for mounting on small surface.
- Extremely thin package.
- Majority carrier conduction.

Mechanical data

- Case: 0402C/SOD-923F standard package, molded plastic.
- Terminals: Gold plated, Solderable per MIL-STD-750, method 2026.
- Polarity: Cathode band & BV
- Mounting position: Any
- Weight: 0.001 grams (approx.).

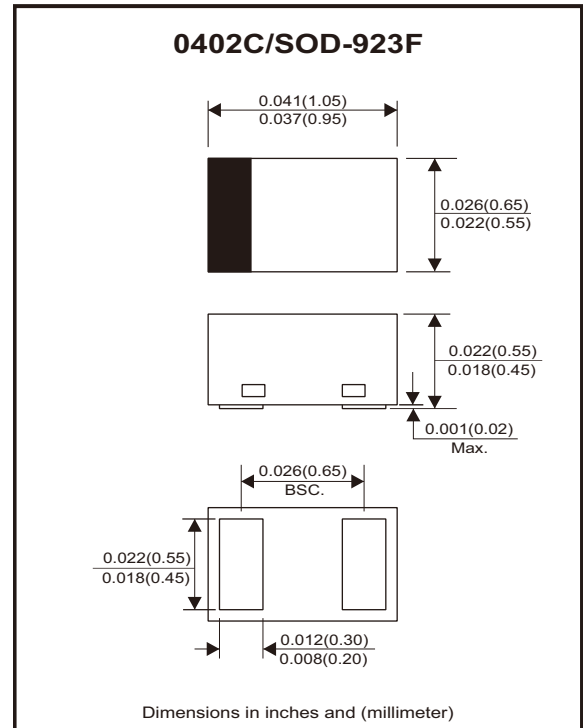

Circuit Diagram



Maximum Rating (at $T_A=25^\circ\text{C}$ unless otherwise noted)

Parameter	Conditions	Symbol	Min	Typ	Max	Unit
Repetitive peak reverse voltage		V_{RRM}			40	V
Reverse voltage		V_R			40	V
Average forward rectified current		I_o			200	mA
Peak forward surge current	8.3 ms single half sine-wave (1 cyc)	I_{FSM}			3	A
Thermal resistance	Junction to ambient	$R_{\theta JA}$		200		$^\circ\text{C/W}$
Junction temperature		T_j	-40		+125	$^\circ\text{C}$
Storage temperature		T_{STG}	-40		+125	$^\circ\text{C}$

Electrical Characteristics (at $T_A=25^\circ\text{C}$ unless otherwise noted)

Parameter	Conditions	Symbol	Min	Typ	Max	Unit
Forward voltage	$I_F = 10\text{mA}$ $I_F = 100\text{mA}$ $I_F = 200\text{mA}$	V_F		0.25	0.30 0.40 0.48	V
Reverse current	$V_R = 10\text{V}$ $V_R = 30\text{V}$	I_R			10 30	μA
Capacitance between terminals	$V_R = 1\text{V}$, $f = 1\text{ MHz}$	C_T		14	20	pF

Rating and Characteristic Curves (CDBQC0240L-HF)

Fig. 1 - Forward Characteristics

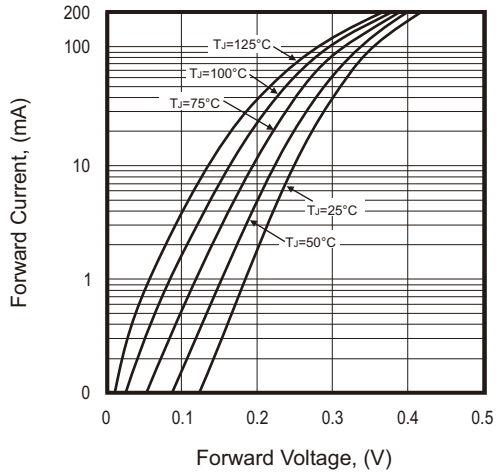

Fig.2 - Reverse Characteristics

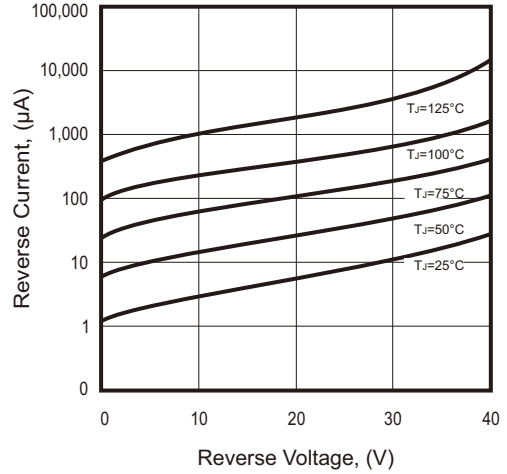

Fig.3 - Typical Capacitance Between Terminals Characteristics

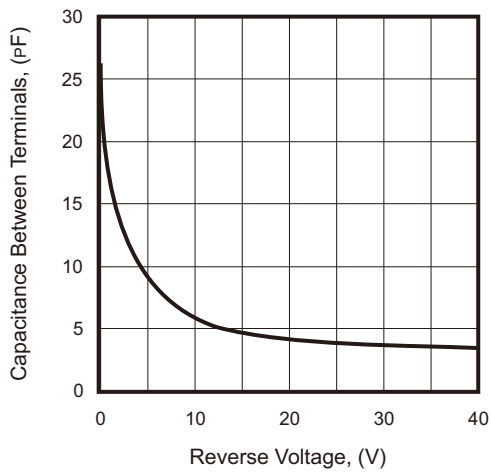
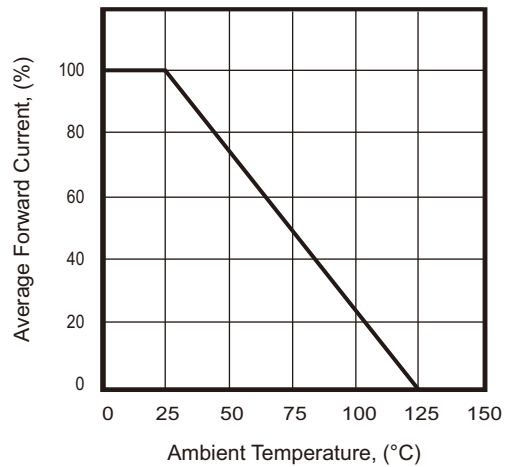
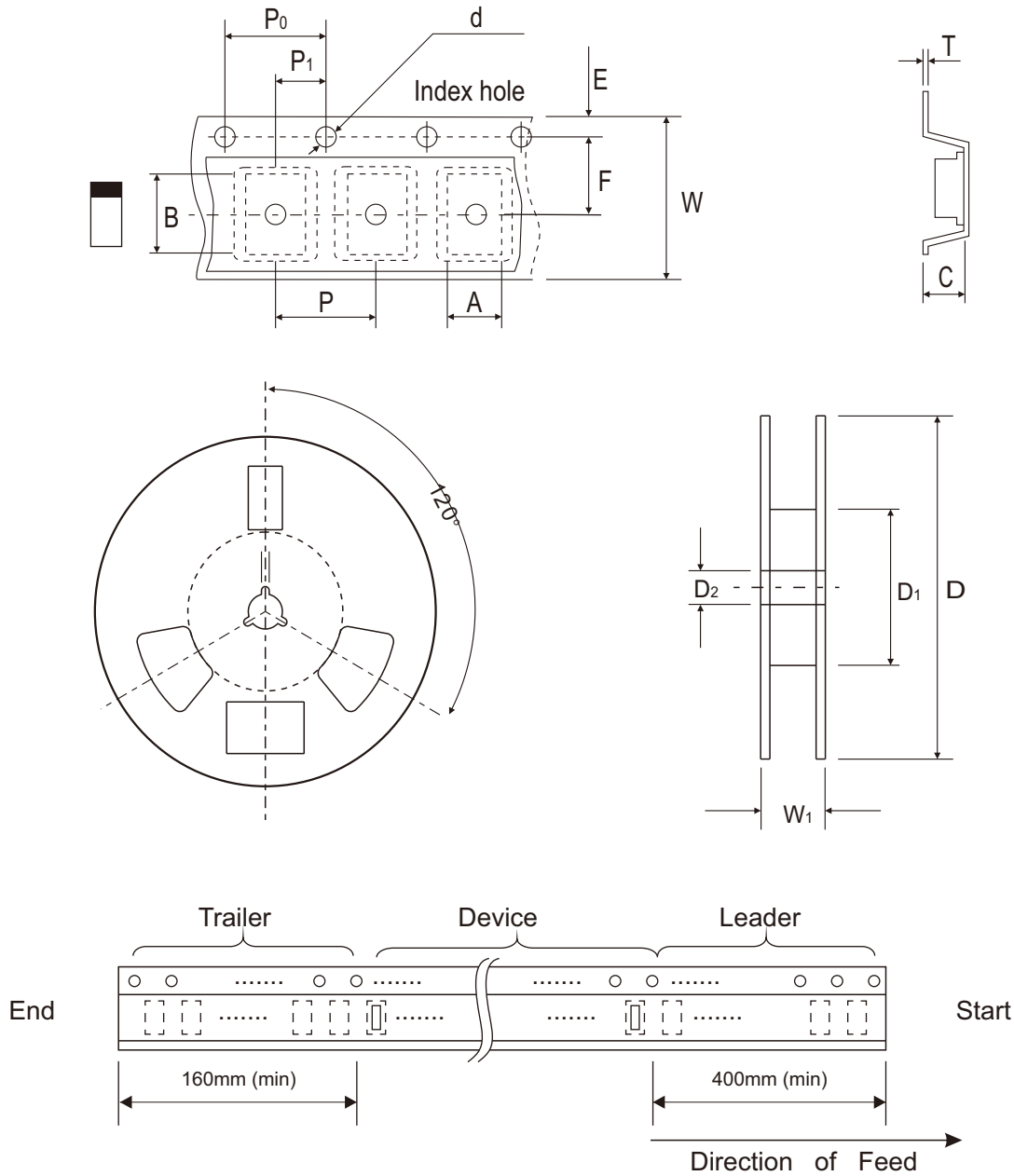

Fig.4 - Current Derating Curve



Reel Taping Specification



0402C (SOD-923F)	SYMBOL	A	B	C	d	D	D ₁	D ₂
	(mm)	0.75 ± 0.05	1.17 ± 0.05	0.65 ± 0.05	1.50 + 0.10 - 0	178.00 ± 1.00	60.00 ± 0.50	13.50 ± 0.20
	(inch)	0.030 ± 0.002	0.046 ± 0.002	0.026 ± 0.002	0.059 + 0.004 - 0	7.008 ± 0.039	2.362 ± 0.020	0.531 ± 0.008

0402C (SOD-923F)	SYMBOL	E	F	P	P ₀	P ₁	T	W	W ₁
	(mm)	1.75 ± 0.10	3.50 ± 0.10	4.00 ± 0.10	4.00 ± 0.10	2.00 ± 0.10	0.20 + 0.02 - 0.05	8.00 ± 0.20	12.00 + 0.50 - 0
	(inch)	0.069 ± 0.004	0.138 ± 0.004	0.157 ± 0.004	0.157 ± 0.004	0.079 ± 0.004	0.008 + 0.001 - 0.002	0.315 ± 0.008	0.472 + 0.020 - 0

Company reserves the right to improve product design, functions and reliability without notice.

REV:C

Marking Code

Part Number	Marking Code
CDBQC0240L-HF	BV



Suggested PAD Layout

SIZE	0402C/SOD-923F	
	(mm)	(inch)
A	0.70	0.028
B	0.40	0.016
C	0.60	0.024
D	1.10	0.043
E	0.30	0.012

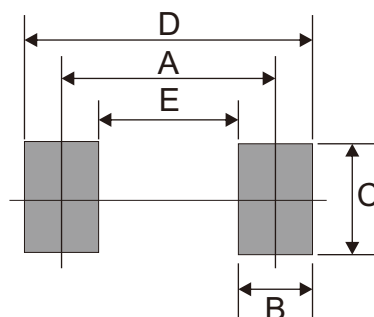

Standard Packaging

Case Type	REEL PACK	
	REEL (pcs)	Reel Size (inch)
0402C/SOD-923F	5,000	7