

CC-E

Insulation type DC-DC converter

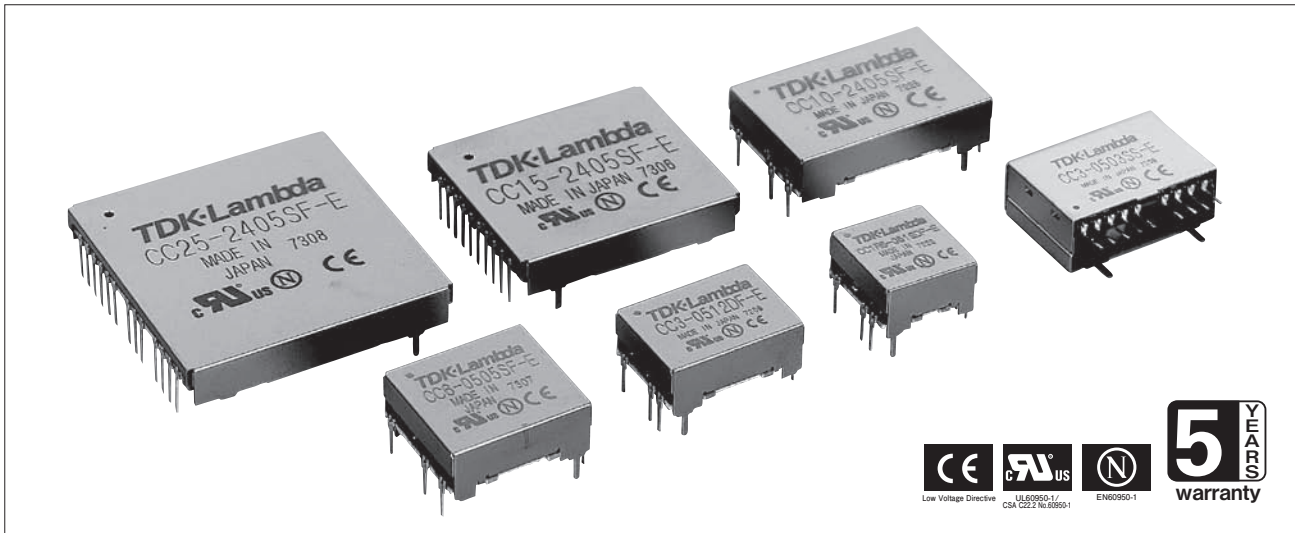

Features

- Mounting area halved compared to existing products
- Nonuse of tantalum capacitor or aluminum electrolytic capacitor
- Remote On/Off function incorporated in all series of products
- High accuracy of $\pm 3\%$ in output voltage (10W of lower single output)
- 5-side metal-shielded low noise design
- Lightweight design with no resin filled up
- Supports DIP insertion, SMD mounting and SIP vertical insertion (3W products)
- Approved by UL60950-1, CSA C22.2 No.60950-1 (C-UL), and EN60950-1 (NEMKO)

Applications

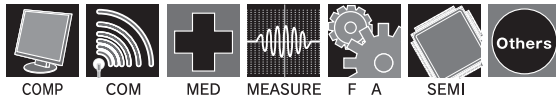

Product Line up

Output power	Input voltage	Model name (output voltage: 3.3V)			Model name (output voltage: 5V)				Model name (output voltage: 12V/15V)				Model name (output voltage: $\pm 12V/\pm 15V$)				
		Output current	DIP type	SMD type	SIP type	Output current	DIP type	SMD type	SIP type	Output current	DIP type	SMD type	SIP type	Output current	DIP type	SMD type	SIP type
1.5W	5V	0.4A	CC1R5-0503SF-E	CC1R5-0503SR-E	-	0.3A	CC1R5-0505SF-E	CC1R5-0505SR-E	-	0.125A (0.1A)	CC1R5-0512SF-E	CC1R5-0512SR-E	-	0.06A (0.05A)	CC1R5-0512DF-E	CC1R5-0512DR-E	-
	12V	0.4A	CC1R5-1203SF-E	CC1R5-1203SR-E	-	0.3A	CC1R5-1205SF-E	CC1R5-1205SR-E	-	0.125A (0.1A)	CC1R5-1212SF-E	CC1R5-1212SR-E	-	0.06A (0.05A)	CC1R5-1212DF-E	CC1R5-1212DR-E	-
	24V	0.4A	CC1R5-2403SF-E	CC1R5-2403SR-E	-	0.3A	CC1R5-2405SF-E	CC1R5-2405SR-E	-	0.125A (0.1A)	CC1R5-2412SF-E	CC1R5-2412SR-E	-	0.06A (0.05A)	CC1R5-2412DF-E	CC1R5-2412DR-E	-
	48V	0.4A	CC1R5-4803SF-E	CC1R5-4803SR-E	-	0.3A	CC1R5-4805SF-E	CC1R5-4805SR-E	-	0.125A (0.1A)	CC1R5-4812SF-E	CC1R5-4812SR-E	-	0.06A (0.05A)	CC1R5-4812DF-E	CC1R5-4812DR-E	-
3W	5V	0.8A	CC3-0503SF-E	CC3-0503SR-E	CC3-0503SS-E	0.6A	CC3-0505SF-E	CC3-0505SR-E	CC3-0505SS-E	0.25A (0.2A)	CC3-0512SF-E	CC3-0512SR-E	CC3-0512SS-E	0.125A (0.1A)	CC3-0512DF-E	CC3-0512DR-E	CC3-0512DS-E
	12V	0.8A	CC3-1203SF-E	CC3-1203SR-E	CC3-1203SS-E	0.6A	CC3-1205SF-E	CC3-1205SR-E	CC3-1205SS-E	0.25A (0.2A)	CC3-1212SF-E	CC3-1212SR-E	CC3-1212SS-E	0.125A (0.1A)	CC3-1212DF-E	CC3-1212DR-E	CC3-1212DS-E
	24V	0.8A	CC3-2403SF-E	CC3-2403SR-E	-	0.6A	CC3-2405SF-E	CC3-2405SR-E	CC3-2405SS-E	0.25A (0.2A)	CC3-2412SF-E	CC3-2412SR-E	CC3-2412SS-E	0.125A (0.1A)	CC3-2412DF-E	CC3-2412DR-E	CC3-2412DS-E
	48V	0.8A	CC3-4803SF-E	CC3-4803SR-E	CC3-4803SS-E	0.6A	CC3-4805SF-E	CC3-4805SR-E	CC3-4805SS-E	0.25A (0.2A)	CC3-4812SF-E	CC3-4812SR-E	-	0.125A (0.1A)	CC3-4812DF-E	CC3-4812DR-E	CC3-4812DS-E
6W	5V	1.2A	CC6-0503SF-E	CC6-0503SR-E	-	1A	CC6-0505SF-E	CC6-0505SR-E	-	0.5A (0.4A)	CC6-0512SF-E	CC6-0512SR-E	-	0.25A (0.2A)	CC6-0512DF-E	CC6-0512DR-E	-
	12V	1.2A	CC6-1203SF-E	CC6-1203SR-E	-	1.2A	CC6-1205SF-E	CC6-1205SR-E	-	0.5A (0.4A)	CC6-1212SF-E	CC6-1212SR-E	-	0.25A (0.2A)	CC6-1212DF-E	CC6-1212DR-E	-
	24V	1.2A	CC6-2403SF-E	CC6-2403SR-E	-	1.2A	CC6-2405SF-E	CC6-2405SR-E	-	0.5A (0.4A)	CC6-2412SF-E	CC6-2412SR-E	-	0.25A (0.2A)	CC6-2412DF-E	CC6-2412DR-E	-
	48V	1.2A	CC6-4803SF-E	CC6-4803SR-E	-	1.2A	CC6-4805SF-E	CC6-4805SR-E	-	0.5A (0.4A)	CC6-4812SF-E	CC6-4812SR-E	-	0.25A (0.2A)	CC6-4812DF-E	CC6-4812DR-E	-
10W	5V	2.5A	CC10-0503SF-E	CC10-0503SR-E	-	2A	CC10-0505SF-E	CC10-0505SR-E	-	0.8A (0.64A)	CC10-0512SF-E	CC10-0512SR-E	-	0.4A (0.32A)	CC10-0512DF-E	CC10-0512DR-E	-
	12V	2.5A	CC10-1203SF-E	CC10-1203SR-E	-	2A	CC10-1205SF-E	CC10-1205SR-E	-	1A (0.8A)	CC10-1212SF-E	CC10-1212SR-E	-	0.45A (0.36A)	CC10-1212DF-E	CC10-1212DR-E	-
	24V	2.5A	CC10-2403SF-E	CC10-2403SR-E	-	2A	CC10-2405SF-E	CC10-2405SR-E	-	1A (0.8A)	CC10-2412SF-E	CC10-2412SR-E	-	0.45A (0.36A)	CC10-2412DF-E	CC10-2412DR-E	-
	48V	2.5A	CC10-4803SF-E	CC10-4803SR-E	-	2A	CC10-4805SF-E	CC10-4805SR-E	-	1A (0.8A)	CC10-4812SF-E	CC10-4812SR-E	-	0.45A (0.36A)	CC10-4812DF-E	CC10-4812DR-E	-
15W	24V	4.5A	CC15-2403SF-E	CC15-2403SR-E	-	3A	CC15-2405SF-E	CC15-2405SR-E	-	-	-	-	-	-	-	-	-
25W	24V	7.5A	CC25-2403SF-E	CC25-2403SR-E	-	5A	CC25-2405SF-E	CC25-2405SR-E	-	-	-	-	-	-	-	-	-

• All specifications are subject to change without notice.

Model-naming method

CC 3 - 05 05 S F - E

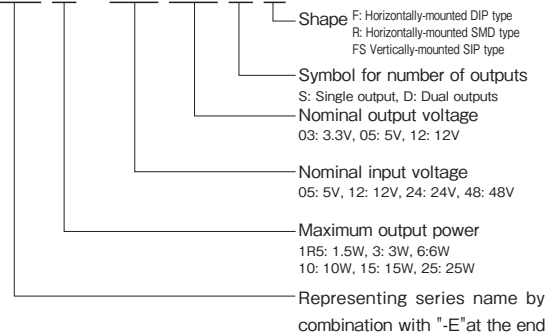

Conformity to RoHS Directive

This means that, in conformity with EU Directive 2002/95/EC, lead, cadmium, mercury, hexavalent chromium, and specific bromine-based flame retardants, PBB and PBDE, have not been used, except for exempted applications.

CC1R5-E Specifications

ITEMS/UNITS		MODEL	CC1R5-0503Sx-E	CC1R5-0505Sx-E	CC1R5-0512Sx-E		CC1R5-0512Dx-E	
Input	Nominal Voltage	V	DC5.0					
	Voltage Range	V	DC4.5-9.0					
	Efficiency (typ) (*1)	%	71	77	80		79	
	Current (typ) (*1)	A	0.372	0.390	0.375		0.380	
Output	Nominal Voltage	VDC	3.3	5	12	15	± 12	± 15
	Maximum Current	A	0.400	0.300	0.125	0.100	0.060	0.050
	Maximum Power (*2)	W	1.32		1.5			
	Maximum Line Regulation (Within input voltage range)	mV	20		40		80	
	Maximum Load Regulation (0-100% load) (*3)	mV	40		100		600	
	Temperature Coefficient (Ambient temperature -40°C to +50°C)		80mV		200mV		300mV	
	Max Power Total Regulation (max) (*4)	%			± 3		± 5	
	Maximum Ripple & Noise (typ/max) (*5)	mVp-p	40/120				30/120	
	Voltage Adjustable Range	VDC	3.15-3.6	4.75-6.0	11.4-15.0		± 11.4 - ± 15.0	
	Function	Over Current Protection (*6)		Available				
Over Voltage Protection			Not available					
Remote ON/OFF Control			Available					
Environment	Operating Temperature	°C	-40 to +85					
	Storage Temperature	°C	-40 to +85					
	Operating Humidity	% RH	5-95 (the conditions of maximum 38°C in wet bulb temperature and non-condensation should be ensured.)					
	Storage Humidity	% RH	5-95 (the conditions of maximum 38°C in wet bulb temperature and non-condensation should be ensured.)					
	Vibration		10-55Hz, 15 minutes sweep and 1.52mm total amplitude, 3 directions, 2h for each					
Isolation	Shock		980m/s ² (100G), 6ms, 6 directions, 3 times for each, in non-operation					
	Withstand Voltage		Between input terminal and case, between input terminal and output terminal, and between output terminal and case: 500VAC (for 1 minute)					
Standards	Isolation Resistance		Between input terminal and case, between input terminal and output terminal, and between output terminal and case: 500VDC, 50MΩ min					
	Safety Standards		UL60950-1, CSA C22.2 No.60950-1 (C-UL), EN60950-1 (NEMKO)					
Mechanical	Weight (typ)	g	3.2					
	Size (W x H x D)	mm	DIP: 16.51 x 8.5 x 16.6 / SMD: 16.51 x 8.8 x 16.6					

Note: "x" in model names is to be replaced by a symbol which represents the terminal configuration (F: DIP/R: SMD) for actual model names.

Note: With nominal input/output voltage, maximum output current, and Ta=25°C, if not specified separately.

Note: For 12V/ ± 12V models, output power can be set to 15V/ ± 15V by connecting the output adjustment terminal TRM to -Vout.

Note: For ± 12V model, output voltage can be set to 24V or 30V single output by making the COM terminal open.

(*1) With nominal input voltage, maximum output current, and Ta=25°C.

(*2) The maximum output power value is between -40°C and +50°C. For use in outside this temperature range, derating is needed.

(*3) In balanced load for dual outputs ("balanced load" means a condition where the +output and -output of load current are equal).

(*4) Output voltage includes input change, load change (balanced load), and temperature change.

(*5) In 50MHz, Ta=25°C.

(*6) Output current restriction method. Automatically resumes when the causes are removed. Never operate the unit under output-short or overload conditions for over 30 seconds.

ITEMS/UNITS		MODEL	CC1R5-1203Sx-E	CC1R5-1205Sx-E	CC1R5-1212Sx-E		CC1R5-1212Dx-E	
Input	Nominal Voltage	V	DC12					
	Voltage Range	V	DC9.0-18					
	Efficiency (typ) (*1)	%	73	78	82		81	
	Current (typ) (*1)	A	0.151	0.160	0.152		0.154	
Output	Nominal Voltage	VDC	3.3	5	12	15	± 12	± 15
	Maximum Current	A	0.400	0.300	0.125	0.100	0.060	0.050
	Maximum Power (*2)	W	1.32		1.5			
	Maximum Line Regulation (Within input voltage range)	mV	20		40		80	
	Maximum Load Regulation (0-100% load) (*3)	mV	40		100		600	
	Temperature Coefficient (Ambient temperature -40°C to +50°C)		80mV		200mV		300mV	
	Max Power Total Regulation (max) (*4)	%			± 3		± 5	
	Maximum Ripple & Noise (typ/max) (*5)	mVp-p	40/120				30/120	
	Voltage Adjustable Range	VDC	3.15-3.6	4.75-6.0	11.4-15.0		± 11.4 - ± 15.0	
	Function	Over Current Protection (*6)		Available				
Over Voltage Protection			Not available					
Remote ON/OFF Control			Available					
Environment	Operating Temperature	°C	-40 to +85					
	Storage Temperature	°C	-40 to +85					
	Operating Humidity	% RH	5-95 (the conditions of maximum 38°C in wet bulb temperature and non-condensation should be ensured.)					
	Storage Humidity	% RH	5-95 (the conditions of maximum 38°C in wet bulb temperature and non-condensation should be ensured.)					
	Vibration		10-55Hz, 15 minutes sweep and 1.52mm total amplitude, 3 directions, 2h for each					
Isolation	Shock		980m/s ² (100G), 6ms, 6 directions, 3 times for each, in non-operation					
	Withstand Voltage		Between input terminal and case, between input terminal and output terminal, and between output terminal and case: 500VAC (for 1 minute)					
Standards	Isolation Resistance		Between input terminal and case, between input terminal and output terminal, and between output terminal and case: 500VDC, 50MΩ min					
	Safety Standards		UL60950-1, CSA C22.2 No.60950-1 (C-UL), EN60950-1 (NEMKO)					
Mechanical	Weight (typ)	g	3.2					
	Size (W x H x D)	mm	DIP: 16.51 x 8.5 x 16.6 / SMD: 16.51 x 8.8 x 16.6					

Note: "x" in model names is to be replaced by a symbol which represents the terminal configuration (F: DIP/R: SMD) for actual model names.

Note: With nominal input/output voltage, maximum output current, and Ta=25°C, if not specified separately.

Note: For 12V/ ± 12V models, output power can be set to 15V/ ± 15V by connecting the output adjustment terminal TRM to -Vout.

Note: For ± 12V model, output voltage can be set to 24V or 30V single output by making the COM terminal open.

(*1) With nominal input voltage, maximum output current, and Ta=25°C.

(*2) The maximum output power value is between -40°C and +50°C. For use in outside this temperature range, derating is needed.

(*3) In balanced load for dual outputs ("balanced load" means a condition where the +output and -output of load current are equal).

(*4) Output voltage includes input change, load change (balanced load), and temperature change.

(*5) In 50MHz, Ta=25°C.

(*6) Output current restriction method. Automatically resumes when the causes are removed. Never operate the unit under output-short or overload conditions for over 30 seconds.

ITEMS/UNITS		MODEL	CC1R5-2403Sx-E	CC1R5-2405Sx-E	CC1R5-2412Sx-E		CC1R5-2412Dx-E	
Input	Nominal Voltage	V	DC24					
	Voltage Range	V	DC18-36					
	Efficiency (typ) (*1)	%	72	77	81		79	
	Current (typ) (*1)	A	0.076	0.081	0.077		0.079	
Output	Nominal Voltage	VDC	3.3	5	12	15	± 12	± 15
	Maximum Current	A	0.400	0.300	0.125	0.100	0.060	0.050
	Maximum Power (*2)	W	1.32		1.5			
	Maximum Line Regulation (Within input voltage range)	mV	20		40		80	
	Maximum Load Regulation (0-100% load) (*3)	mV	40		100		600	
	Temperature Coefficient (Ambient temperature -40°C to +50°C)		80mV		200mV		300mV	
	Max Power Total Regulation (max) (*4)	%			± 3		± 5	
	Maximum Ripple & Noise (typ/max) (*5)	mVp-p	40/120				30/120	
	Voltage Adjustable Range	VDC	3.15-3.6	4.75-6.0	11.4-15.0		± 11.4- ± 15.0	
	Function	Over Current Protection (*6)		Available				
Over Voltage Protection			Not available					
Remote ON/OFF Control			Available					
Environment	Operating Temperature	°C	-40 to +85					
	Storage Temperature	°C	-40 to +85					
	Operating Humidity	% RH	5-95 (the conditions of maximum 38°C in wet bulb temperature and non-condensation should be ensured.)					
	Storage Humidity	% RH	5-95 (the conditions of maximum 38°C in wet bulb temperature and non-condensation should be ensured.)					
	Vibration		10-55Hz, 15 minutes sweep and 1.52mm total amplitude, 3 directions, 2h for each					
	Shock		980m/s ² (100G), 6ms, 6 directions, 3 times for each, in non-operation					
Isolation	Withstand Voltage		Between input terminal and case, between input terminal and output terminal, and between output terminal and case: 500VAC (for 1 minute)					
	Isolation Resistance		Between input terminal and case, between input terminal and output terminal, and between output terminal and case: 500VDC, 50MΩ min					
Standards	Safety Standards		UL60950-1, CSA C22.2 No.60950-1 (C-UL), EN60950-1 (NEMKO)					
Mechanical	Weight (typ)	g	3.2					
	Size (W x H x D)	mm	DIP: 16.51 x 8.5 x 16.6 / SMD: 16.51 x 8.8 x 16.6					

Note: "x" in model names is to be replaced by a symbol which represents the terminal configuration (F: DIP/R: SMD) for actual model names.

Note: With nominal input/output voltage, maximum output current, and Ta=25°C, if not specified separately.

Note: For 12V/ ± 12V models, output power can be set to 15V/ ± 15V by connecting the output adjustment terminal TRM to -Vout.

Note: For ± 12V model, output voltage can be set to 24V or 30V single output by making the COM terminal open.

(*1) With nominal input voltage, maximum output current, and Ta=25°C.

(*2) The maximum output power value is between -40°C and +50°C. For use in outside this temperature range, derating is needed.

(*3) In balanced load for dual outputs ("balanced load" means a condition where the +output and -output of load current are equal).

(*4) Output voltage includes input change, load change (balanced load), and temperature change.

(*5) In 50MHz, Ta=25°C.

(*6) Output current restriction method. Automatically resumes when the causes are removed. Never operate the unit under output-short or overload conditions for over 30 seconds.

ITEMS/UNITS		MODEL	CC1R5-4803Sx-E	CC1R5-4805Sx-E	CC1R5-4812Sx-E		CC1R5-4812Dx-E	
Input	Nominal Voltage	V	DC48					
	Voltage Range	V	DC36-76					
	Efficiency (typ) (*1)	%	70	76	80		79	
	Current (typ) (*1)	A	0.039	0.041	0.039		0.040	
Output	Nominal Voltage	VDC	3.3	5	12	15	± 12	± 15
	Maximum Current	A	0.400	0.300	0.125	0.100	0.060	0.050
	Maximum Power (*2)	W	1.32		1.5			
	Maximum Line Regulation (Within input voltage range)	mV	20		40		80	
	Maximum Load Regulation (0-100% load) (*3)	mV	40		100		600	
	Temperature Coefficient (Ambient temperature -40°C to +50°C)		80mV		200mV		300mV	
	Max Power Total Regulation (max) (*4)	%			± 3		± 5	
	Maximum Ripple & Noise (typ/max) (*5)	mVp-p	40/120				30/120	
	Voltage Adjustable Range	VDC	3.15-3.6	4.75-6.0	11.4-15.0		± 11.4- ± 15.0	
	Function	Over Current Protection (*6)		Available				
Over Voltage Protection			Not available					
Remote ON/OFF Control			Available					
Environment	Operating Temperature	°C	-40 to +85					
	Storage Temperature	°C	-40 to +85					
	Operating Humidity	% RH	5-95 (the conditions of maximum 38°C in wet bulb temperature and non-condensation should be ensured.)					
	Storage Humidity	% RH	5-95 (the conditions of maximum 38°C in wet bulb temperature and non-condensation should be ensured.)					
	Vibration		10-55Hz, 15 minutes sweep and 1.52mm total amplitude, 3 directions, 2h for each					
	Shock		980m/s ² (100G), 6ms, 6 directions, 3 times for each, in non-operation					
Isolation	Withstand Voltage		Between input terminal and case, between input terminal and output terminal, and between output terminal and case: 500VAC (for 1 minute)					
	Isolation Resistance		Between input terminal and case, between input terminal and output terminal, and between output terminal and case: 500VDC, 50MΩ min					
Standards	Safety Standards		UL60950-1, CSA C22.2 No.60950-1 (C-UL), EN60950-1 (NEMKO)					
Mechanical	Weight (typ)	g	3.2					
	Size (W x H x D)	mm	DIP: 16.51 x 8.5 x 16.6 / SMD: 16.51 x 8.8 x 16.6					

Note: "x" in model names is to be replaced by a symbol which represents the terminal configuration (F: DIP/R: SMD) for actual model names.

Note: With nominal input/output voltage, maximum output current, and Ta=25°C, if not specified separately.

Note: For 12V/ ± 12V models, output power can be set to 15V/ ± 15V by connecting the output adjustment terminal TRM to -Vout.

Note: For ± 12V model, output voltage can be set to 24V or 30V single output by making the COM terminal open.

(*1) With nominal input voltage, maximum output current, and Ta=25°C.

(*2) The maximum output power value is between -40°C and +50°C. For use in outside this temperature range, derating is needed.

(*3) In balanced load for dual outputs ("balanced load" means a condition where the +output and -output of load current are equal).

(*4) Output voltage includes input change, load change (balanced load), and temperature change.

(*5) In 50MHz, Ta=25°C.

(*6) Output current restriction method. Automatically resumes when the causes are removed. Never operate the unit under output-short or overload conditions for over 30 seconds.

Outline Drawing

CC1R5-xxxxxF-E (DIP type)

Shape/Dimensions

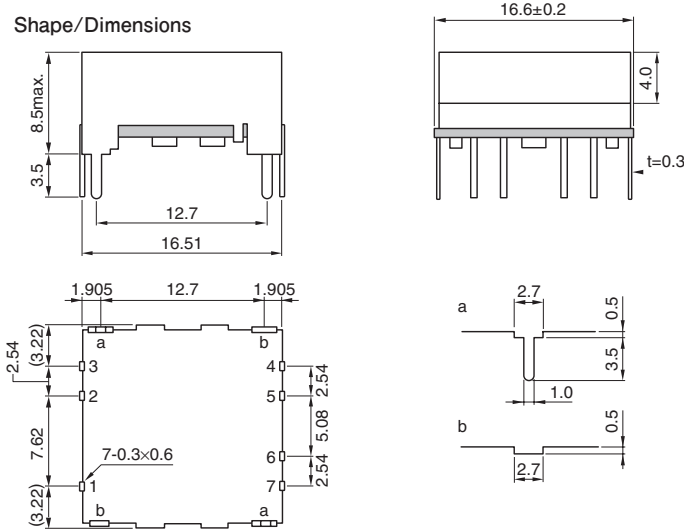

Recommended measurements for mounting board

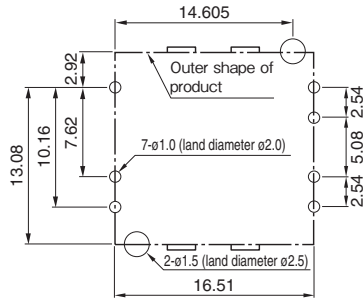

Unit: mm
Allowable tolerance is ±0.5 if not specified separately.

CC1R5-xxxxxR-E (SMD type)

Shape/Dimensions

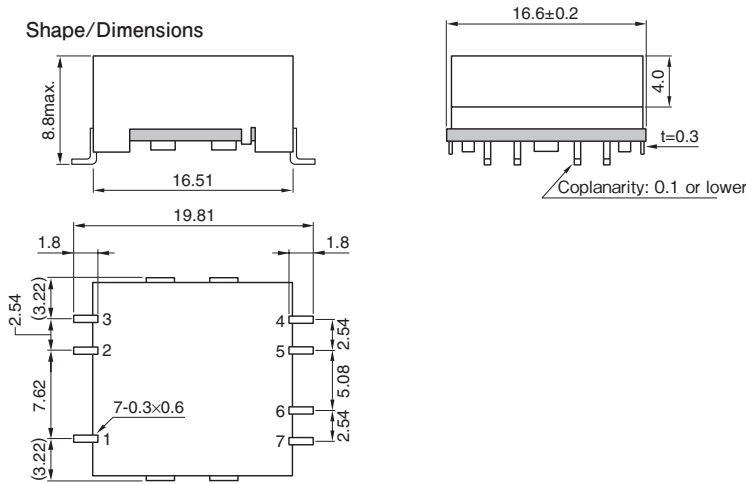

Recommended measurements for mounting board

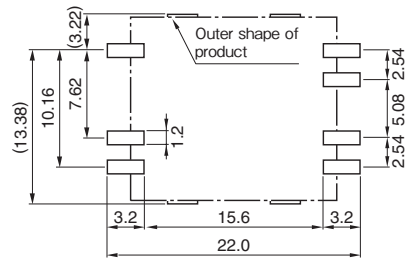

Unit: mm
Allowable tolerance is ±0.5 if not specified separately.

Connection diagram

CC1R5-xxxxSx-E

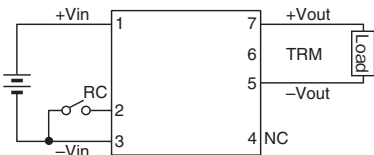

Terminal connections

No.1	+Vin
No.2	RC
No.3	-Vin
No.4	NC
No.5	-Vout
No.6	TRM
No.7	+Vout

CC1R5-xxxxDx-E

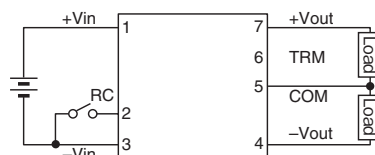

Terminal connections

No.1	+Vin
No.2	RC
No.3	-Vin
No.4	-Vout
No.5	Common out
No.6	TRM
No.7	+Vout

Derating Curve

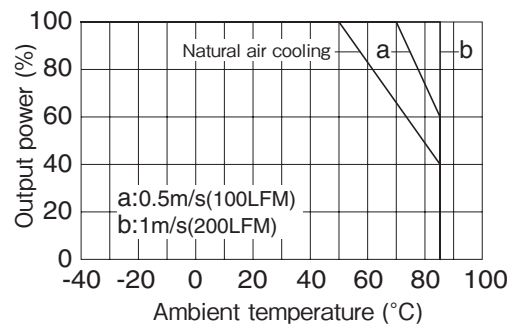

Output power derating by ambient temperature (common specification)

CC3-E Specifications

ITEMS/UNITS		MODEL	CC3-0503Sx-E	CC3-0505Sx-E	CC3-0512Sx-E		CC3-0512Dx-E	
Input	Nominal Voltage	V	DC5.0					
	Voltage Range	V	DC4.5-9.0					
	Efficiency (typ) (*1)	%	73	77	82		81	
	Current (typ) (*1)	A	0.723	0.779	0.732		0.741	
Output	Nominal Voltage	VDC	3.3	5	12	15	± 12	± 15
	Maximum Current	A	0.800	0.600	0.250	0.200	0.125	0.100
	Maximum Power (*2)	W	2.64		3			
	Maximum Line Regulation (Within input voltage range)	mV	20		40		80	
	Maximum Load Regulation (0-100% load) (*3)	mV	40		100		600	
	Temperature Coefficient (Ambient temperature -40°C to +50°C)		80mV		200mV		300mV	
	Max Power Total Regulation (max) (*4)	%	± 3					
	Maximum Ripple & Noise (typ/max) (*5)	mVp-p	40/120		30/120			
	Voltage Adjustable Range	VDC	3.15-3.6	4.75-6.0	11.4-15.0		± 11.4- ± 15.0	
	Function	Over Current Protection (*6)		Available				
Over Voltage Protection			Not available					
Remote ON/OFF Control			Available					
Environment	Operating Temperature	°C	-40 to +85					
	Storage Temperature	°C	-40 to +85					
	Operating Humidity	% RH	5-95 (the conditions of maximum 38°C in wet bulb temperature and non-condensation should be ensured.)					
	Storage Humidity	% RH	5-95 (the conditions of maximum 38°C in wet bulb temperature and non-condensation should be ensured.)					
Isolation	Vibration		10-55Hz, 15 minutes sweep and 1.52mm total amplitude, X/Y/Z 3 directions, 2h for each					
	Shock		980m/s ² (100G), 6ms, 6 directions, 3 times for each, in non-operation					
	Withstand Voltage		Between input terminal and case, between input terminal and output terminal, and between output terminal and case: 500VAC (for 1 minute)					
Standards	Isolation Resistance		Between input terminal and case, between input terminal and output terminal, and between output terminal and case: 500VDC, 50MΩ min					
	Safety Standards		UL60950-1, CSA C22.2 No.60950-1 (C-UL), EN60950-1 (NEMKO)					
Mechanical	Weight (typ)	g	4.5					
	Size (W x H x D)	mm	DIP: 22.86 x 8.5 x 16.6 / SMD: 22.86 x 8.8 x 16.6					

Note: "x" in model names is to be replaced by a symbol which represents the terminal configuration (F: DIP/R: SMD) for actual model names.

Note: With nominal input/output voltage, maximum output current, and Ta=25°C, if not specified separately.

Note: For 12V/ ± 12V models, output power can be set to 15V/ ± 15V by connecting the output adjustment terminal TRM to -Vout.

Note: For ± 12V model, output voltage can be set to 24V or 30V single output by making the COM terminal open.

(*1) With nominal input voltage, maximum output current, and Ta=25°C.

(*2) The maximum output power value is between -40°C and +50°C. For use in outside this temperature range, derating is needed.

(*3) In balanced load for dual outputs ("balanced load" means a condition where the +output and -output of load current are equal).

(*4) Output voltage includes input change, load change (balanced load), and temperature change.

(*5) In 50MHz, Ta=25°C.

(*6) Output current restriction method. Automatically resumes when the causes are removed. Never operate the unit under output-shortened or overload conditions for over 30 seconds.

ITEMS/UNITS		MODEL	CC3-1203Sx-E	CC3-1205Sx-E	CC3-1212Sx-E		CC3-1212Dx-E	
Input	Nominal Voltage	V	DC12					
	Voltage Range	V	DC9.0-18					
	Efficiency (typ) (*1)	%	74	79	82		81	
	Current (typ) (*1)	A	0.297	0.316	0.305		0.309	
Output	Nominal Voltage	VDC	3.3	5	12	15	± 12	± 15
	Maximum Current	A	0.800	0.600	0.250	0.200	0.125	0.100
	Maximum Power (*2)	W	2.64		3			
	Maximum Line Regulation (Within input voltage range)	mV	20		40		80	
	Maximum Load Regulation (0-100% load) (*3)	mV	40		100		600	
	Temperature Coefficient (Ambient temperature -40°C to +50°C)		80mV		200mV		300mV	
	Max Power Total Regulation (max) (*4)	%	± 3					
	Maximum Ripple & Noise (typ/max) (*5)	mVp-p	40/120		30/120			
	Voltage Adjustable Range	VDC	3.15-3.6	4.75-6.0	11.4-15.0		± 11.4- ± 15.0	
	Function	Over Current Protection (*6)		Available				
Over Voltage Protection			Not available					
Remote ON/OFF Control			Available					
Environment	Operating Temperature	°C	-40 to +85					
	Storage Temperature	°C	-40 to +85					
	Operating Humidity	% RH	5-95 (the conditions of maximum 38°C in wet bulb temperature and non-condensation should be ensured.)					
	Storage Humidity	% RH	5-95 (the conditions of maximum 38°C in wet bulb temperature and non-condensation should be ensured.)					
Isolation	Vibration		10-55Hz, 15 minutes sweep and 1.52mm total amplitude, X/Y/Z 3 directions, 2h for each					
	Shock		980m/s ² (100G), 6ms, 6 directions, 3 times for each, in non-operation					
	Withstand Voltage		Between input terminal and case, between input terminal and output terminal, and between output terminal and case: 500VAC (for 1 minute)					
Standards	Isolation Resistance		Between input terminal and case, between input terminal and output terminal, and between output terminal and case: 500VDC, 50MΩ min					
	Safety Standards		UL60950-1, CSA C22.2 No.60950-1 (C-UL), EN60950-1 (NEMKO)					
Mechanical	Weight (typ)	g	4.5					
	Size (W x H x D)	mm	DIP: 22.86 x 8.5 x 16.6 / SMD: 22.86 x 8.8 x 16.6					

Note: "x" in model names is to be replaced by a symbol which represents the terminal configuration (F: DIP/R: SMD) for actual model names.

Note: With nominal input/output voltage, maximum output current, and Ta=25°C, if not specified separately.

Note: For 12V/ ± 12V models, output power can be set to 15V/ ± 15V by connecting the output adjustment terminal TRM to -Vout.

Note: For ± 12V model, output voltage can be set to 24V or 30V single output by making the COM terminal open.

(*1) With nominal input voltage, maximum output current, and Ta=25°C.

(*2) The maximum output power value is between -40°C and +50°C. For use in outside this temperature range, derating is needed.

(*3) In balanced load for dual outputs ("balanced load" means a condition where the +output and -output of load current are equal).

(*4) Output voltage includes input change, load change (balanced load), and temperature change.

(*5) In 50MHz, Ta=25°C.

(*6) Output current restriction method. Automatically resumes when the causes are removed. Never operate the unit under output-shortened or overload conditions for over 30 seconds.

ITEMS/UNITS		MODEL	CC3-2403Sx-E	CC3-2405Sx-E	CC3-2412Sx-E		CC3-2412Dx-E		
Input	Nominal Voltage	V	DC24						
	Voltage Range	V	DC18-36						
	Efficiency (typ) (*1)	%	73	78	82		81		
	Current (typ) (*1)	A	0.151	0.160	0.152		0.154		
Output	Nominal Voltage	VDC	3.3	5	12	15	± 12	± 15	
	Maximum Current	A	0.800	0.600	0.250	0.200	0.125	0.100	
	Maximum Power (*2)	W	2.64	3					
	Maximum Line Regulation (Within input voltage range)	mV	20		40		80		
	Maximum Load Regulation (0-100% load) (*3)	mV	40		100		600		
	Temperature Coefficient (Ambient temperature -40°C to +50°C)		80mV		200mV		300mV		
	Max Power Total Regulation (max) (*4)	%	± 3					± 5	
	Maximum Ripple & Noise (typ/max) (*5)	mVp-p	40/120		30/120				
	Voltage Adjustable Range	VDC	3.15-3.6	4.75-6.0	11.4-15.0		± 11.4- ± 15.0		
Function	Over Current Protection (*6)		Available						
	Over Voltage Protection		Not available						
	Remote ON/OFF Control		Available						
Environment	Operating Temperature	°C	-40 to +85						
	Storage Temperature	°C	-40 to +85						
	Operating Humidity	% RH	5-95 (the conditions of maximum 38°C in wet bulb temperature and non-condensation should be ensured.)						
	Storage Humidity	% RH	5-95 (the conditions of maximum 38°C in wet bulb temperature and non-condensation should be ensured.)						
Isolation	Vibration		10-55Hz, 15 minutes sweep and 1.52mm total amplitude, X/Y/Z 3 directions, 2h for each						
	Shock		980m/s ² (100G), 6ms, 6 directions, 3 times for each, in non-operation						
	Withstand Voltage		Between input terminal and case, between input terminal and output terminal, and between output terminal and case: 500VAC (for 1 minute)						
Standards	Isolation Resistance		Between input terminal and case, between input terminal and output terminal, and between output terminal and case: 500VDC, 50MΩ min						
	Safety Standards		UL60950-1, CSA C22.2 No.60950-1 (C-UL), EN60950-1 (NEMKO)						
Mechanical	Weight (typ)	g	4.5						
	Size (W x H x D)	mm	DIP: 22.86 x 8.5 x 16.6 / SMD: 22.86 x 8.8 x 16.6						

Note: "x" in model names is to be replaced by a symbol which represents the terminal configuration (F: DIP/R: SMD) for actual model names.

Note: With nominal input/output voltage, maximum output current, and Ta=25°C, if not specified separately.

Note: For 12V/ ± 12V models, output power can be set to 15V/ ± 15V by connecting the output adjustment terminal TRM to -Vout.

Note: For ± 12V model, output voltage can be set to 24V or 30V single output by making the COM terminal open.

(*1) With nominal input voltage, maximum output current, and Ta=25°C.

(*2) The maximum output power value is between -40°C and +50°C. For use in outside this temperature range, derating is needed.

(*3) In balanced load for dual outputs ("balanced load" means a condition where the +output and -output of load current are equal).

(*4) Output voltage includes input change, load change (balanced load), and temperature change.

(*5) In 50MHz, Ta=25°C.

(*6) Output current restriction method. Automatically resumes when the causes are removed. Never operate the unit under output-shortened or overload conditions for over 30 seconds.

ITEMS/UNITS		MODEL	CC3-4803Sx-E	CC3-4805Sx-E	CC3-4812Sx-E		CC3-4812Dx-E		
Input	Nominal Voltage	V	DC48						
	Voltage Range	V	DC36-76						
	Efficiency (typ) (*1)	%	73	79	81		80		
	Current (typ) (*1)	A	0.075	0.079	0.077		0.078		
Output	Nominal Voltage	VDC	3.3	5	12	15	± 12	± 15	
	Maximum Current	A	0.800	0.600	0.250	0.200	0.125	0.100	
	Maximum Power (*2)	W	2.64	3					
	Maximum Line Regulation (Within input voltage range)	mV	20		40		80		
	Maximum Load Regulation (0-100% load) (*3)	mV	40		100		600		
	Temperature Coefficient (Ambient temperature -40°C to +50°C)		80mV		200mV		300mV		
	Max Power Total Regulation (max) (*4)	%	± 3					± 5	
	Maximum Ripple & Noise (typ/max) (*5)	mVp-p	40/120		30/120				
	Voltage Adjustable Range	VDC	3.15-3.6	4.75-6.0	11.4-15.0		± 11.4- ± 15.0		
Function	Over Current Protection (*6)		Available						
	Over Voltage Protection		Not available						
	Remote ON/OFF Control		Available						
Environment	Operating Temperature	°C	-40 to +85						
	Storage Temperature	°C	-40 to +85						
	Operating Humidity	% RH	5-95 (the conditions of maximum 38°C in wet bulb temperature and non-condensation should be ensured.)						
	Storage Humidity	% RH	5-95 (the conditions of maximum 38°C in wet bulb temperature and non-condensation should be ensured.)						
Isolation	Vibration		10-55Hz, 15 minutes sweep and 1.52mm total amplitude, X/Y/Z 3 directions, 2h for each						
	Shock		980m/s ² (100G), 6ms, 6 directions, 3 times for each, in non-operation						
	Withstand Voltage		Between input terminal and case, between input terminal and output terminal, and between output terminal and case: 500VAC (for 1 minute)						
Standards	Isolation Resistance		Between input terminal and case, between input terminal and output terminal, and between output terminal and case: 500VDC, 50MΩ min						
	Safety Standards		UL60950-1, CSA C22.2 No.60950-1 (C-UL), EN60950-1 (NEMKO)						
Mechanical	Weight (typ)	g	4.5						
	Size (W x H x D)	mm	DIP: 22.86 x 8.5 x 16.6 / SMD: 22.86 x 8.8 x 16.6						

Note: "x" in model names is to be replaced by a symbol which represents the terminal configuration (F: DIP/R: SMD) for actual model names.

Note: With nominal input/output voltage, maximum output current, and Ta=25°C, if not specified separately.

Note: For 12V/ ± 12V models, output power can be set to 15V/ ± 15V by connecting the output adjustment terminal TRM to -Vout.

Note: For ± 12V model, output voltage can be set to 24V or 30V single output by making the COM terminal open.

(*1) With nominal input voltage, maximum output current, and Ta=25°C.

(*2) The maximum output power value is between -40°C and +50°C. For use in outside this temperature range, derating is needed.

(*3) In balanced load for dual outputs ("balanced load" means a condition where the +output and -output of load current are equal).

(*4) Output voltage includes input change, load change (balanced load), and temperature change.

(*5) In 50MHz, Ta=25°C.

(*6) Output current restriction method. Automatically resumes when the causes are removed. Never operate the unit under output-shortened or overload conditions for over 30 seconds.

Outline Drawing

CC3-xxxxxF-E (DIP type)

Shape/Dimensions

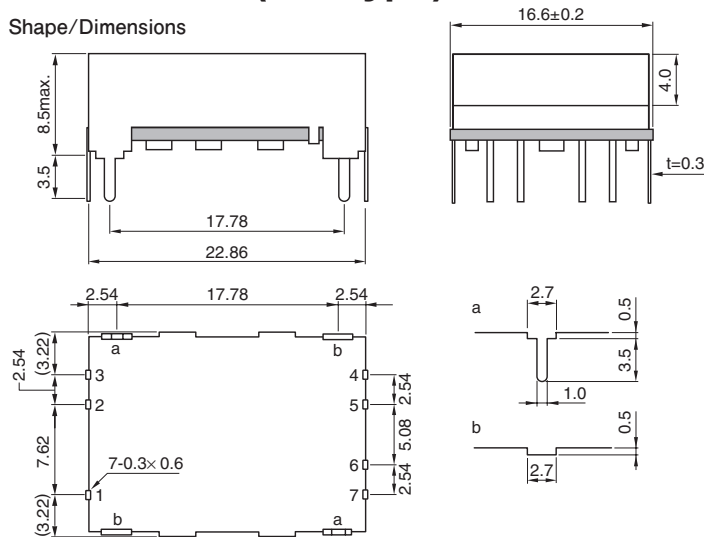

Recommended measurements for mounting board

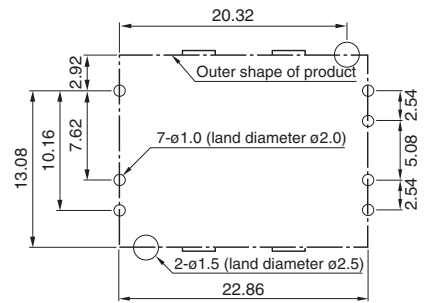

Unit: mm
Allowable tolerance is ±0.5 if not specified separately.

CC3-xxxxxR-E (SMD type)

Shape/Dimensions

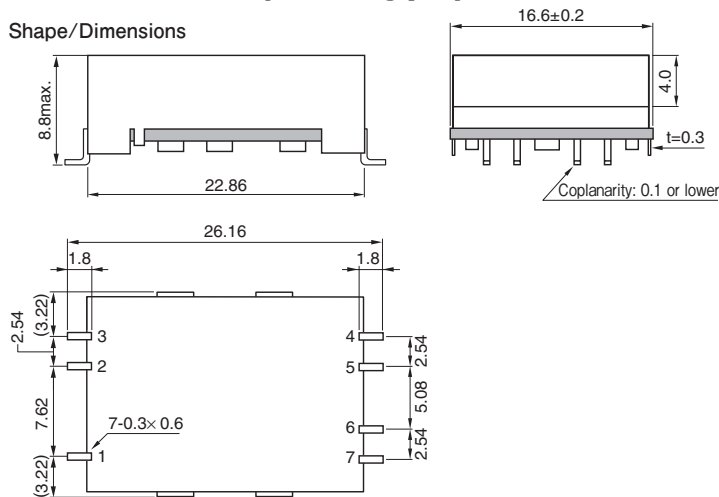

Recommended measurements for mounting board

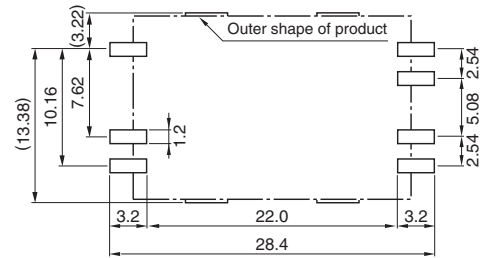

Unit: mm
Allowable tolerance is ±0.5 if not specified separately.

Connection diagram

CC3-xxxxSx-E

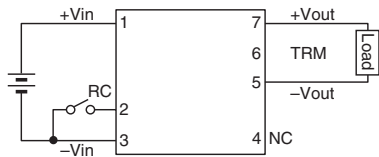

Terminal connections

No.1	+Vin
No.2	RC
No.3	-Vin
No.4	NC
No.5	-Vout
No.6	TRM
No.7	+Vout

CC3-xxxxDx-E

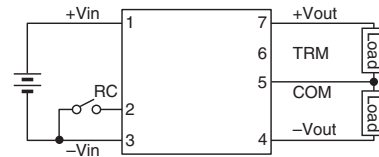

Terminal connections

No.1	+Vin
No.2	RC
No.3	-Vin
No.4	-Vout
No.5	Common out
No.6	TRM
No.7	+Vout

Derating Curve

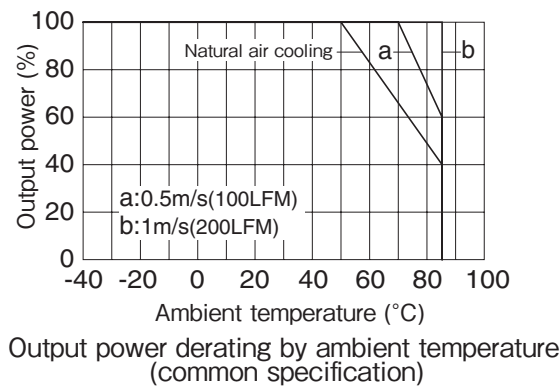

CC3-E Specifications

ITEMS/UNITS		MODEL	CC3-0503SS-E	CC3-0505SS-E	CC3-0512SS-E	CC3-0512DS-E		
Input	Nominal Voltage	V	DC5.0					
	Voltage Range	V	DC4.5-9.0					
	Efficiency (typ) (*1)	%	73	77	82	81		
	Current (typ) (*1)	A	0.723	0.779	0.732	0.741		
Output	Nominal Voltage	VDC	3.3	5	12	15	± 12	± 15
	Maximum Current	A	0.800	0.600	0.250	0.200	0.125	0.100
	Maximum Power (*2)	W	2.64	3				
	Maximum Line Regulation (Within input voltage range)	mV	20		40		80	
	Maximum Load Regulation (0-100% load) (*3)	mV	40		100		600	
	Temperature Coefficient (Ambient temperature -40°C to +50°C)		80mV		200mV		300mV	
	Max Power Total Regulation (max)(*4)	%	± 3				± 5	
	Maximum Ripple & Noise (typ/max) (*5)	mVp-p	40/120		30/120			
	Voltage Adjustable Range	VDC	3.15-3.67	4.75-6.0	11.4-15.0		± 11.4- ± 15.0	
	Function	Over Current Protection (*6)		Available				
Over Voltage Protection			Not available					
Remote ON/OFF Control			Available					
Environment	Operating Temperature	°C	-40 to +85					
	Storage Temperature	°C	-40 to +85					
	Operating Humidity	% RH	5-95 (the conditions of maximum 38°C in wet bulb temperature and non-condensation should be ensured.)					
	Storage Humidity	% RH	5-95 (the conditions of maximum 38°C in wet bulb temperature and non-condensation should be ensured.)					
	Vibration		10-55Hz, 15 minutes sweep and 1.52mm total amplitude, 3 directions, 2h for each					
Isolation	Shock		980m/s ² (100G), 6ms, 6 directions, 3 times for each, in non-operation					
	Withstand Voltage		Between input terminal and case, between input terminal and output terminal, and between output terminal and case: 500VAC (for 1 minute)					
Standards	Isolation Resistance		Between input terminal and case, between input terminal and output terminal, and between output terminal and case: 500VDC, 50MΩ min					
	Safety Standards		UL60950-1, CSA C22.2 No.60950-1 (C-UL), EN60950-1 (NEMKO)					
Mechanical	Weight (typ)	g	7					
	Size (W x H x D)	mm	27.8 x 17.9 x 9.2					

Note: With nominal input/output voltage, maximum output current, and Ta=25°C, if not specified separately.

Note: For 12V/ ± 12V models, output power can be set to 15V/ ± 15V by connecting the output adjustment terminal TRM to -Vout.

Note: For ± 12V model, output voltage can be set to 24V or 30V single output by making the COM terminal open.

(*1) With nominal input voltage, maximum output current, and Ta=25°C.

(*2) The maximum output power value is between -40°C and +50°C. For use in outside this temperature range, derating is needed.

(*3) In balanced load for dual outputs ("balanced load" means a condition where the +output and -output of load current are equal).

(*4) Output voltage includes input change, load change (balanced load), and temperature change.

(*5) In 50MHz, Ta=25°C.

(*6) Output current restriction method. Automatically resumes when the causes are removed. Never operate the unit under output-short or overload conditions for over 30 seconds.

ITEMS/UNITS		MODEL	CC3-1205SS-E	CC3-1212SS-E	CC3-1212DS-E			
Input	Nominal Voltage	V	DC12					
	Voltage Range	V	DC9.0-18					
	Efficiency (typ) (*1)	%	79	82				
	Current (typ) (*1)	A	0.316	0.305				
Output	Nominal Voltage	VDC	5	12	15	± 12	± 15	
	Maximum Current	A	0.600	0.250	0.200	0.125	0.100	
	Maximum Power (*2)	W	3					
	Maximum Line Regulation (Within input voltage range)	mV	20		40		80	
	Maximum Load Regulation (0-100% load) (*3)	mV	40		100		600	
	Temperature Coefficient (Ambient temperature -40°C to +50°C)		80mV		200mV		300mV	
	Max Power Total Regulation (max)(*4)	%	± 3				± 5	
	Maximum Ripple & Noise (typ/max) (*5)	mVp-p	40/120		30/120			
	Voltage Adjustable Range	VDC	4.75-6.0	11.4-15.0		± 11.4- ± 15.0		
	Function	Over Current Protection (*6)		Available				
Over Voltage Protection			Not available					
Remote ON/OFF Control			Available					
Environment	Operating Temperature	°C	-40 to +85					
	Storage Temperature	°C	-40 to +85					
	Operating Humidity	% RH	5-95 (the conditions of maximum 38°C in wet bulb temperature and non-condensation should be ensured.)					
	Storage Humidity	% RH	5-95 (the conditions of maximum 38°C in wet bulb temperature and non-condensation should be ensured.)					
	Vibration		10-55Hz, 15 minutes sweep and 1.52mm total amplitude, 3 directions, 2h for each					
Isolation	Shock		980m/s ² (100G), 6ms, 6 directions, 3 times for each, in non-operation					
	Withstand Voltage		Between input terminal and case, between input terminal and output terminal, and between output terminal and case: 500VAC (for 1 minute)					
Standards	Isolation Resistance		Between input terminal and case, between input terminal and output terminal, and between output terminal and case: 500VDC, 50MΩ min					
	Safety Standards		UL60950-1, CSA C22.2 No.60950-1 (C-UL), EN60950-1 (NEMKO)					
Mechanical	Weight (typ)	g	7					
	Size (W x H x D)	mm	27.8 x 17.9 x 9.2					

Note: With nominal input/output voltage, maximum output current, and Ta=25°C, if not specified separately.

Note: For 12V/ ± 12V models, output power can be set to 15V/ ± 15V by connecting the output adjustment terminal TRM to -Vout.

Note: For ± 12V model, output voltage can be set to 24V or 30V single output by making the COM terminal open.

(*1) With nominal input voltage, maximum output current, and Ta=25°C.

(*2) The maximum output power value is between -40°C and +50°C. For use in outside this temperature range, derating is needed.

(*3) In balanced load for dual outputs ("balanced load" means a condition where the +output and -output of load current are equal).

(*4) Output voltage includes input change, load change (balanced load), and temperature change.

(*5) In 50MHz, Ta=25°C.

(*6) Output current restriction method. Automatically resumes when the causes are removed. Never operate the unit under output-short or overload conditions for over 30 seconds.

ITEMS/UNITS		MODEL	CC3-2403SS-E	CC3-2405SS-E	CC3-2412SS-E	CC3-2412DS-E		
Input	Nominal Voltage	V	DC24					
	Voltage Range	V	DC18-36					
	Efficiency (typ) (*1)	%	73	78	82	81		
	Current (typ) (*1)	A	0.151	0.160	0.152	0.154		
Output	Nominal Voltage	VDC	3.3	5	12	15	± 12	± 15
	Maximum Current	A	0.800	0.600	0.250	0.200	0.125	0.100
	Maximum Power (*2)	W	2.64	3				
	Maximum Line Regulation (Within input voltage range)	mV	20		40		80	
	Maximum Load Regulation (0-100% load) (*3)	mV	40		100		600	
	Temperature Coefficient (Ambient temperature -40°C to +50°C)		80mV		200mV		300mV	
	Max Power Total Regulation (max)(*4)	%	± 3				± 5	
	Maximum Ripple & Noise (typ/max) (*5)	mVp-p	40/120		30/120			
	Voltage Adjustable Range	VDC	3.15-3.67	4.75-6.0	11.4-15.0		± 11.4- ± 15.0	
	Function	Over Current Protection (*6)		Available				
Over Voltage Protection			Not available					
Remote ON/OFF Control			Available					
Environment	Operating Temperature	°C	-40 to +85					
	Storage Temperature	°C	-40 to +85					
	Operating Humidity	% RH	5-95 (the conditions of maximum 38°C in wet bulb temperature and non-condensation should be ensured.)					
	Storage Humidity	% RH	5-95 (the conditions of maximum 38°C in wet bulb temperature and non-condensation should be ensured.)					
	Vibration		10-55Hz, 15 minutes sweep and 1.52mm total amplitude, 3 directions, 2h for each					
	Shock		980m/s ² (100G), 6ms, 6 directions, 3 times for each, in non-operation					
Isolation	Withstand Voltage		Between input terminal and case, between input terminal and output terminal, and between output terminal and case: 500VAC (for 1 minute)					
	Isolation Resistance		Between input terminal and case, between input terminal and output terminal, and between output terminal and case: 500VDC, 50MΩ min					
Standards	Safety Standards		UL60950-1, CSA C22.2 No.60950-1 (C-UL), EN60950-1 (NEMKO)					
Mechanical	Weight (typ)	g	7					
	Size (W x H x D)	mm	27.8 x 17.9 x 9.2					

Note: With nominal input/output voltage, maximum output current, and Ta=25°C, if not specified separately.

Note: For 12V/ ± 12V models, output power can be set to 15V/ ± 15V by connecting the output adjustment terminal TRM to -Vout.

Note: For ± 12V model, output voltage can be set to 24V or 30V single output by making the COM terminal open.

(*1) With nominal input voltage, maximum output current, and Ta=25°C.

(*2) The maximum output power value is between -40°C and +50°C. For use in outside this temperature range, derating is needed.

(*3) In balanced load for dual outputs ("balanced load" means a condition where the +output and -output of load current are equal).

(*4) Output voltage includes input change, load change (balanced load), and temperature change.

(*5) In 50MHz, Ta=25°C.

(*6) Output current restriction method. Automatically resumes when the causes are removed. Never operate the unit under output-short or overload conditions for over 30 seconds.

ITEMS/UNITS		MODEL	CC3-4803SS-E	CC3-4805SS-E	CC3-4812DS-E	
Input	Nominal Voltage	V	DC48			
	Voltage Range	V	DC36-76			
	Efficiency (typ) (*1)	%	73	79	82	
	Current (typ) (*1)	A	0.075	0.079	0.076	
Output	Nominal Voltage	VDC	3.3	5	± 12	± 15
	Maximum Current	A	0.800	0.600	0.125	0.100
	Maximum Power (*2)	W	2.64	3		
	Maximum Line Regulation (Within input voltage range)	mV	20		80	
	Maximum Load Regulation (0-100% load) (*3)	mV	40		600	
	Temperature Coefficient (Ambient temperature -40°C to +50°C)		80mV		300mV	
	Max Power Total Regulation (max)(*4)	%	± 3			± 5
	Maximum Ripple & Noise (typ/max) (*5)	mVp-p	40/120		30/120	
	Voltage Adjustable Range	VDC	3.15-3.6	4.75-6.0	± 11.4- ± 15.0	
	Function	Over Current Protection (*6)		Available		
Over Voltage Protection			Not available			
Remote ON/OFF Control			Available			
Environment	Operating Temperature	°C	-40 to +85			
	Storage Temperature	°C	-40 to +85			
	Operating Humidity	% RH	5-95 (the conditions of maximum 38°C in wet bulb temperature and non-condensation should be ensured.)			
	Storage Humidity	% RH	5-95 (the conditions of maximum 38°C in wet bulb temperature and non-condensation should be ensured.)			
	Vibration		10-55Hz, 15 minutes sweep and 1.52mm total amplitude, 3 directions, 2h for each			
	Shock		980m/s ² (100G), 6ms, 6 directions, 3 times for each, in non-operation			
Isolation	Withstand Voltage		Between input terminal and case, between input terminal and output terminal, and between output terminal and case: 500VAC (for 1 minute)			
	Isolation Resistance		Between input terminal and case, between input terminal and output terminal, and between output terminal and case: 500VDC, 50MΩ min			
Standards	Safety Standards		UL60950-1, CSA C22.2 No.60950-1 (C-UL), EN60950-1 (NEMKO)			
Mechanical	Weight (typ)	g	7			
	Size (W x H x D)	mm	27.8 x 17.9 x 9.2			

Note: With nominal input/output voltage, maximum output current, and Ta=25°C, if not specified separately.

Note: For 12V/ ± 12V models, output power can be set to 15V/ ± 15V by connecting the output adjustment terminal TRM to -Vout.

Note: For ± 12V model, output voltage can be set to 24V or 30V single output by making the COM terminal open.

(*1) With nominal input voltage, maximum output current, and Ta=25°C.

(*2) The maximum output power value is between -40°C and +50°C. For use in outside this temperature range, derating is needed.

(*3) In balanced load for dual outputs ("balanced load" means a condition where the +output and -output of load current are equal).

(*4) Output voltage includes input change, load change (balanced load), and temperature change.

(*5) In 50MHz, Ta=25°C.

(*6) Output current restriction method. Automatically resumes when the causes are removed. Never operate the unit under output-short or overload conditions for over 30 seconds.

Outline Drawing

CC3-xxxxS-E (SIP type)

Shape/Dimensions

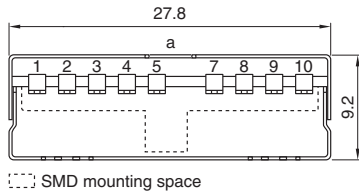
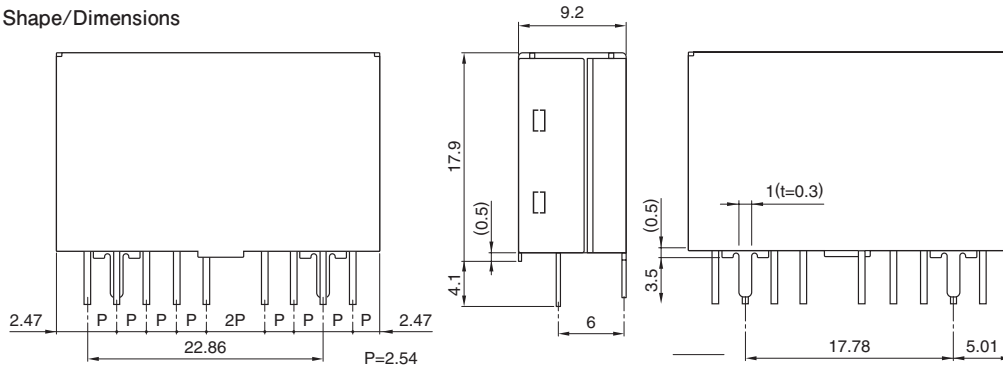

□ SMD mounting space

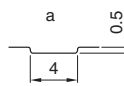

Unit: mm

Allowable tolerance is ±0.5 if not specified separately.

Recommended measurements for mounting board

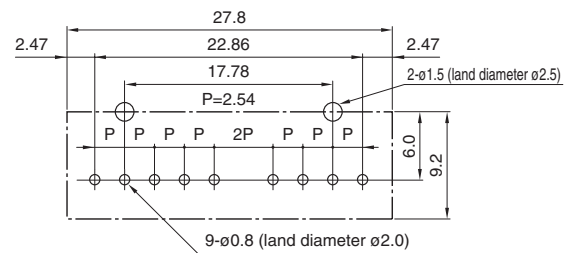

Connection diagram

CC3-xxxxSS-E

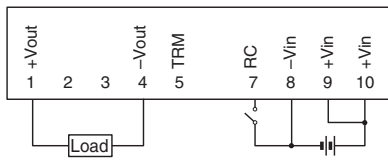

Terminal connections

No.1	+Vout
No.2	NC
No.3	NC
No.4	-Vout
No.5	TRM
No.6	NC
No.7	RC
No.8	-Vin
No.9	+Vin
No.10	+Vin

CC3-xxxxDS-E

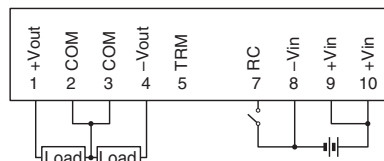

Terminal connections

No.1	+Vout
No.2	COM
No.3	COM
No.4	-Vout
No.5	TRM
No.6	NC
No.7	RC
No.8	-Vin
No.9	+Vin
No.10	+Vin

Derating Curve

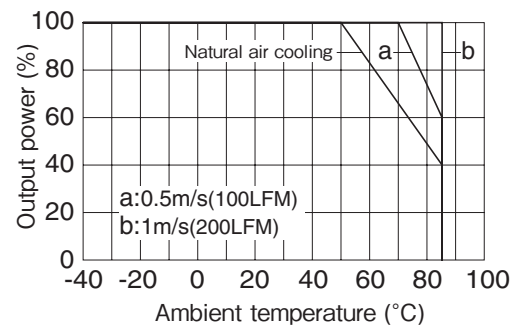

Output power derating by ambient temperature (common specification)

CC6-E Specifications

ITEMS/UNITS		MODEL	CC6-0503Sx-E	CC6-0505Sx-E	CC6-0512Sx-E		CC6-0512Dx-E	
Input	Nominal Voltage	V	DC5.0					
	Voltage Range	V	DC4.5-9.0					
	Efficiency (typ) (*1)	%	76	79	82			
	Current (typ) (*1)	A	1.042	1.266	1.463			
Output	Nominal Voltage	VDC	3.3	5	12	15	± 12	± 15
	Maximum Current	A	1.200	1.000	0.500	0.400	0.250	0.200
	Maximum Power (*2)	W	3.96	5	6			
	Maximum Line Regulation(Within input voltage range)	mV	20		40		80	
	Maximum Load Regulation (0-100% load) (*3)	mV	40		100		600	
	Temperature Coefficient (Ambient temperature -40°C to +50°C)		80mV		200mV		300mV	
	Max Power Total Regulation (max)(*4)	%	± 3					
	Maximum Ripple & Noise (typ/max) (*5)	mVp-p	40/120			30/120		
	Voltage Adjustable Range	VDC	3.15-3.6	4.75-6.0	11.4-15.0		± 11.4- ± 15.0	
	Function	Over Current Protection (*6)		Available				
Over Voltage Protection			Not available					
Remote ON/OFF Control			Available					
Environment	Operating Temperature	°C	-40 to +85					
	Storage Temperature	°C	-40 to +85					
	Operating Humidity	% RH	5-95 (the conditions of maximum 38°C in wet bulb temperature and non-condensation should be ensured.)					
	Storage Humidity	% RH	5-95 (the conditions of maximum 38°C in wet bulb temperature and non-condensation should be ensured.)					
	Vibration		10-55Hz, 15 minutes sweep and 1.52mm total amplitude, 3 directions, 2h for each					
	Shock		980m/s ² (100G), 6ms, 6 directions, 3 times for each, in non-operation					
Isolation	Withstand Voltage		Between input terminal and case, between input terminal and output terminal, and between output terminal and case: 500VAC (for 1 minute)					
	Isolation Resistance		Between input terminal and case, between input terminal and output terminal, and between output terminal and case: 500VDC, 50MΩ min					
Standards	Safety Standards		UL60950-1, CSA C22.2 No.60950-1 (C-UL), EN60950-1 (NEMKO)					
	Weight (typ)	g	5.8					
Mechanical	Size (W x H x D)	mm	DIP: 22.86 x 8.5 x 21.1 / SMD: 22.86 x 8.8 x 21.1					

Note: "x" in model names is to be replaced by a symbol which represents the terminal configuration (F: DIP/R: SMD) for actual model names.

Note: With nominal input/output voltage, maximum output current, and Ta=25°C, if not specified separately.

Note: For 12V/ ± 12V models, output power can be set to 15V/ ± 15V by connecting the output adjustment terminal TRM to -Vout.

Note: For ± 12V model, output voltage can be set to 24V or 30V single output by making the COM terminal open.

(*1) With nominal input voltage, maximum output current, and Ta=25°C.

(*2) The maximum output power value is between -40°C and +50°C. For use in outside this temperature range, derating is needed.

(*3) In balanced load for dual outputs ("balanced load" means a condition where the +output and -output of load current are equal).

(*4) Output voltage includes input change, load change (balanced load), and temperature change.

(*5) In 50MHz, Ta=25°C.

(*6) Output current restriction method. Automatically resumes when the causes are removed. Never operate the unit under output-short or overload conditions for over 30 seconds.

ITEMS/UNITS		MODEL	CC6-1203Sx-E	CC6-1205Sx-E	CC6-1212Sx-E		CC6-1212Dx-E	
Input	Nominal Voltage	V	DC12					
	Voltage Range	V	DC9.0-18					
	Efficiency (typ) (*1)	%	78	82	85			
	Current (typ) (*1)	A	0.423	0.610	0.588			
Output	Nominal Voltage	VDC	3.3	5	12	15	± 12	± 15
	Maximum Current	A	1.200	1.000	0.500	0.400	0.250	0.200
	Maximum Power (*2)	W	3.96	5	6			
	Maximum Line Regulation(Within input voltage range)	mV	20		40		80	
	Maximum Load Regulation (0-100% load) (*3)	mV	40		100		600	
	Temperature Coefficient (Ambient temperature -40°C to +50°C)		80mV		200mV		300mV	
	Max Power Total Regulation (max)(*4)	%	± 3					
	Maximum Ripple & Noise (typ/max) (*5)	mVp-p	40/120			30/120		
	Voltage Adjustable Range	VDC	3.15-3.6	4.75-6.0	11.4-15.0		± 11.4- ± 15.0	
	Function	Over Current Protection (*6)		Available				
Over Voltage Protection			Not available					
Remote ON/OFF Control			Available					
Environment	Operating Temperature	°C	-40 to +85					
	Storage Temperature	°C	-40 to +85					
	Operating Humidity	% RH	5-95 (the conditions of maximum 38°C in wet bulb temperature and non-condensation should be ensured.)					
	Storage Humidity	% RH	5-95 (the conditions of maximum 38°C in wet bulb temperature and non-condensation should be ensured.)					
	Vibration		10-55Hz, 15 minutes sweep and 1.52mm total amplitude, 3 directions, 2h for each					
	Shock		980m/s ² (100G), 6ms, 6 directions, 3 times for each, in non-operation					
Isolation	Withstand Voltage		Between input terminal and case, between input terminal and output terminal, and between output terminal and case: 500VAC (for 1 minute)					
	Isolation Resistance		Between input terminal and case, between input terminal and output terminal, and between output terminal and case: 500VDC, 50MΩ min					
Standards	Safety Standards		UL60950-1, CSA C22.2 No.60950-1 (C-UL), EN60950-1 (NEMKO)					
	Weight (typ)	g	5.8					
Mechanical	Size (W x H x D)	mm	DIP: 22.86 x 8.5 x 21.1 / SMD: 22.86 x 8.8 x 21.1					

Note: "x" in model names is to be replaced by a symbol which represents the terminal configuration (F: DIP/R: SMD) for actual model names.

Note: With nominal input/output voltage, maximum output current, and Ta=25°C, if not specified separately.

Note: For 12V/ ± 12V models, output power can be set to 15V/ ± 15V by connecting the output adjustment terminal TRM to -Vout.

Note: For ± 12V model, output voltage can be set to 24V or 30V single output by making the COM terminal open.

(*1) With nominal input voltage, maximum output current, and Ta=25°C.

(*2) The maximum output power value is between -40°C and +50°C. For use in outside this temperature range, derating is needed.

(*3) In balanced load for dual outputs ("balanced load" means a condition where the +output and -output of load current are equal).

(*4) Output voltage includes input change, load change (balanced load), and temperature change.

(*5) In 50MHz, Ta=25°C.

(*6) Output current restriction method. Automatically resumes when the causes are removed. Never operate the unit under output-short or overload conditions for over 30 seconds.

ITEMS/UNITS		MODEL	CC6-2403Sx-E	CC6-2405Sx-E	CC6-2412Sx-E		CC6-2412Dx-E		
Input	Nominal Voltage	V	DC24						
	Voltage Range	V	DC18-36						
	Efficiency (typ) (*1)	%	77	81	87		86		
	Current (typ) (*1)	A	0.214	0.309	0.287		0.291		
Output	Nominal Voltage	VDC	3.3	5	12	15	± 12	± 15	
	Maximum Current	A	1.200		0.500	0.400	0.250	0.200	
	Maximum Power (*2)	W	3.96	6					
	Maximum Line Regulation (Within input voltage range)	mV	20		40		80		
	Maximum Load Regulation (0-100% load) (*3)	mV	40		100		600		
	Temperature Coefficient (Ambient temperature -40°C to +50°C)		80mV		200mV		300mV		
	Max Power Total Regulation (max)(*4)	%					± 3		± 5
	Maximum Ripple & Noise (typ/max) (*5)	mVp-p	40/120				30/120		
	Voltage Adjustable Range	VDC	3.15-3.6	4.75-6.0	11.4-15.0		± 11.4- ± 15.0		
	Function	Over Current Protection (*6)		Available					
Over Voltage Protection			Not available						
Remote ON/OFF Control			Available						
Environment	Operating Temperature	°C	-40 to +85						
	Storage Temperature	°C	-40 to +85						
	Operating Humidity	% RH	5-95 (the conditions of maximum 38°C in wet bulb temperature and non-condensation should be ensured.)						
	Storage Humidity	% RH	5-95 (the conditions of maximum 38°C in wet bulb temperature and non-condensation should be ensured.)						
	Vibration		10-55Hz, 15 minutes sweep and 1.52mm total amplitude, 3 directions, 2h for each						
	Shock		980m/s ² (100G), 6ms, 6 directions, 3 times for each, in non-operation						
Isolation	Withstand Voltage		Between input terminal and case, between input terminal and output terminal, and between output terminal and case: 500VAC (for 1 minute)						
	Isolation Resistance		Between input terminal and case, between input terminal and output terminal, and between output terminal and case: 500VDC, 50MΩ min						
Standards	Safety Standards		UL60950-1, CSA C22.2 No.60950-1 (C-UL), EN60950-1 (NEMKO)						
	Weight (typ)	g	5.8						
Mechanical	Size (W x H x D)	mm	DIP: 22.86 x 8.5 x 21.1 / SMD: 22.86 x 8.8 x 21.1						

Note: "x" in model names is to be replaced by a symbol which represents the terminal configuration (F: DIP/R: SMD) for actual model names.

Note: With nominal input/output voltage, maximum output current, and Ta=25°C, if not specified separately.

Note: For 12V/ ± 12V models, output power can be set to 15V/ ± 15V by connecting the output adjustment terminal TRM to -Vout.

Note: For ± 12V model, output voltage can be set to 24V or 30V single output by making the COM terminal open.

(*1) With nominal input voltage, maximum output current, and Ta=25°C.

(*2) The maximum output power value is between -40°C and +50°C. For use in outside this temperature range, derating is needed.

(*3) In balanced load for dual outputs ("balanced load" means a condition where the +output and -output of load current are equal).

(*4) Output voltage includes input change, load change (balanced load), and temperature change.

(*5) In 50MHz, Ta=25°C.

(*6) Output current restriction method. Automatically resumes when the causes are removed. Never operate the unit under output-short or overload conditions for over 30 seconds.

ITEMS/UNITS		MODEL	CC6-4803Sx-E	CC6-4805Sx-E	CC6-4812Sx-E		CC6-4812Dx-E		
Input	Nominal Voltage	V	DC48						
	Voltage Range	V	DC36-76						
	Efficiency (typ) (*1)	%	77	81	86		86		
	Current (typ) (*1)	A	0.107	0.154	0.145		0.145		
Output	Nominal Voltage	VDC	3.3	5	12	15	± 12	± 15	
	Maximum Current	A	1.200		0.500	0.400	0.250	0.200	
	Maximum Power (*2)	W	3.96	6					
	Maximum Line Regulation (Within input voltage range)	mV	20		40		80		
	Maximum Load Regulation (0-100% load) (*3)	mV	40		100		600		
	Temperature Coefficient (Ambient temperature -40°C to +50°C)		80mV		200mV		300mV		
	Max Power Total Regulation (max)(*4)	%					± 3		± 5
	Maximum Ripple & Noise (typ/max) (*5)	mVp-p	40/120				30/120		
	Voltage Adjustable Range	VDC	3.15-3.6	4.75-6.0	11.4-15.0		± 11.4- ± 15.0		
	Function	Over Current Protection (*6)		Available					
Over Voltage Protection			Not available						
Remote ON/OFF Control			Available						
Environment	Operating Temperature	°C	-40 to +85						
	Storage Temperature	°C	-40 to +85						
	Operating Humidity	% RH	5-95 (the conditions of maximum 38°C in wet bulb temperature and non-condensation should be ensured.)						
	Storage Humidity	% RH	5-95 (the conditions of maximum 38°C in wet bulb temperature and non-condensation should be ensured.)						
	Vibration		10-55Hz, 15 minutes sweep and 1.52mm total amplitude, 3 directions, 2h for each						
	Shock		980m/s ² (100G), 6ms, 6 directions, 3 times for each, in non-operation						
Isolation	Withstand Voltage		Between input terminal and case, between input terminal and output terminal, and between output terminal and case: 500VAC (for 1 minute)						
	Isolation Resistance		Between input terminal and case, between input terminal and output terminal, and between output terminal and case: 500VDC, 50MΩ min						
Standards	Safety Standards		UL60950-1, CSA C22.2 No.60950-1 (C-UL), EN60950-1 (NEMKO)						
	Weight (typ)	g	5.8						
Mechanical	Size (W x H x D)	mm	DIP: 22.86 x 8.5 x 21.1 / SMD: 22.86 x 8.8 x 21.1						

Note: "x" in model names is to be replaced by a symbol which represents the terminal configuration (F: DIP/R: SMD) for actual model names.

Note: With nominal input/output voltage, maximum output current, and Ta=25°C, if not specified separately.

Note: For 12V/ ± 12V models, output power can be set to 15V/ ± 15V by connecting the output adjustment terminal TRM to -Vout.

Note: For ± 12V model, output voltage can be set to 24V or 30V single output by making the COM terminal open.

(*1) With nominal input voltage, maximum output current, and Ta=25°C.

(*2) The maximum output power value is between -40°C and +50°C. For use in outside this temperature range, derating is needed.

(*3) In balanced load for dual outputs ("balanced load" means a condition where the +output and -output of load current are equal).

(*4) Output voltage includes input change, load change (balanced load), and temperature change.

(*5) In 50MHz, Ta=25°C.

(*6) Output current restriction method. Automatically resumes when the causes are removed. Never operate the unit under output-short or overload conditions for over 30 seconds.

Outline Drawing

CC6-xxxxF-E (DIP type)

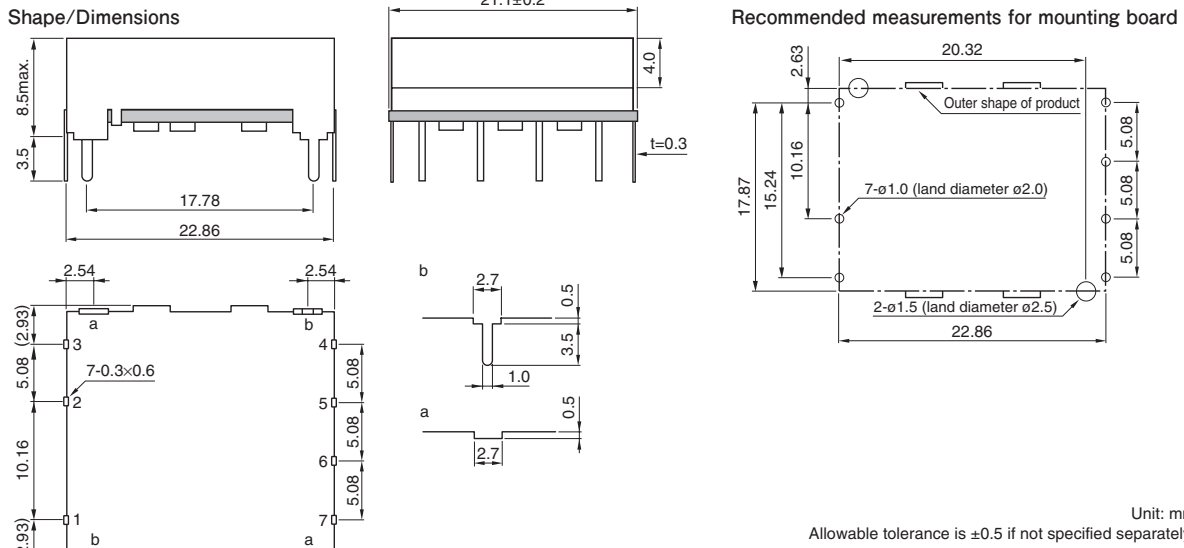

CC6-xxxxR-E (SMD type)

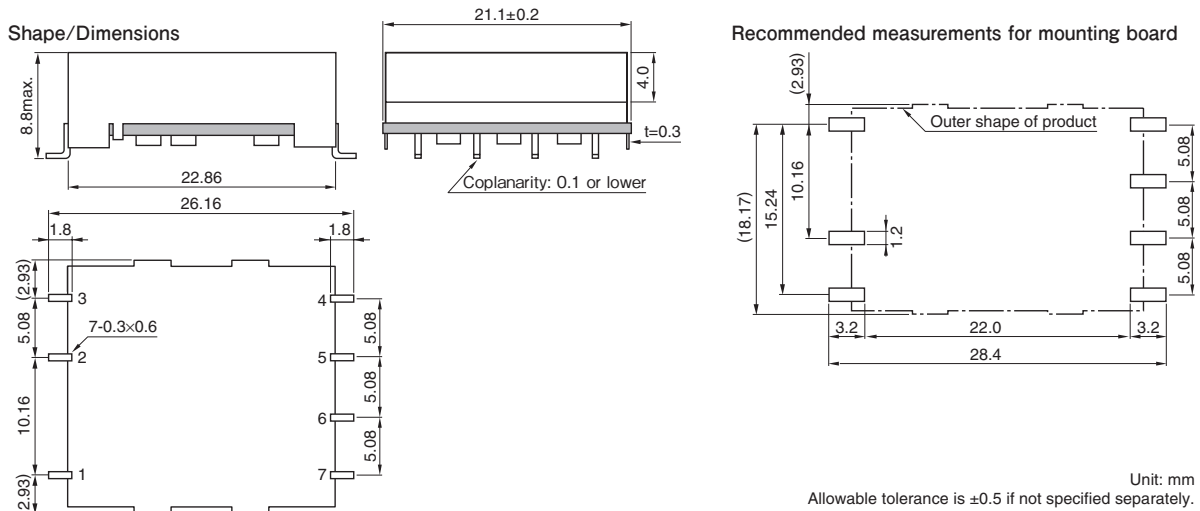

Connection diagram

CC6-xxxxSx-E

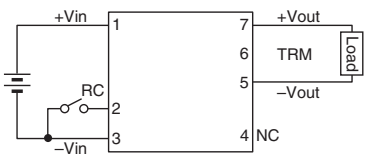

Terminal connections

- No.1 +Vin
- No.2 RC
- No.3 -Vin
- No.4 NC
- No.5 -Vout
- No.6 TRM
- No.7 +Vout

CC6-xxxxDx-E

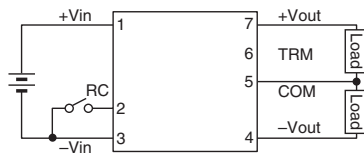

Terminal connections

- No.1 +Vin
- No.2 RC
- No.3 -Vin
- No.4 -Vout
- No.5 Common out
- No.6 TRM
- No.7 +Vout

Derating Curve

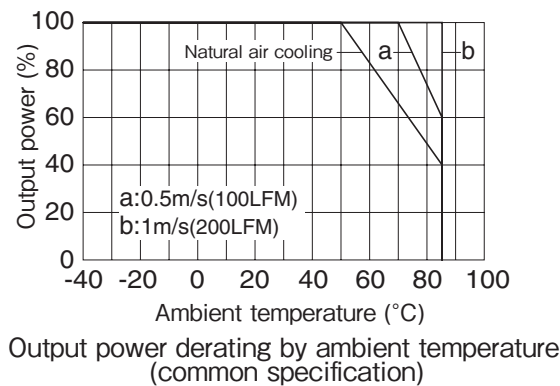

CC10-E Specifications

ITEMS/UNITS		MODEL	CC10-0503Sx-E	CC10-0505Sx-E	CC10-0512Sx-E		CC10-0512Dx-E	
Input	Nominal Voltage	V	DC5.0					
	Voltage Range	V	DC4.5-9.0					
	Efficiency (typ) (*1)	%	84					
	Current (typ) (*1)	A	1.964	2.381	2.286		2.313	
Output	Nominal Voltage	VDC	3.3	5	12	15	± 12	± 15
	Maximum Current	A	2.500	2.000	0.800	0.640	0.400	0.320
	Maximum Power (*2)	W	8.25	10	9.6			
	Maximum Line Regulation (Within input voltage range)	mV	20		40		80	
	Maximum Load Regulation (0-100% load) (*3)	mV	40		100		600	
	Temperature Coefficient (Ambient temperature -40°C to +50°C)		80mV		200mV		300mV	
	Max Power Total Regulation (max) (*4)	%	± 3					
	Maximum Ripple & Noise (typ/max) (*5)	mVp-p	40/120			30/120		
	Voltage Adjustable Range	VDC	3.15-3.6	4.75-6.0	11.4-15.0		± 11.4- ± 15.0	
	Function	Over Current Protection (*6)		Available				
Over Voltage Protection			Not available					
Remote ON/OFF Control			Available					
Environment	Operating Temperature	°C	-40 to +85					
	Storage Temperature	°C	-40 to +85					
	Operating Humidity	% RH	5-95 (the conditions of maximum 38°C in wet bulb temperature and non-condensation should be ensured.)					
	Storage Humidity	% RH	5-95 (the conditions of maximum 38°C in wet bulb temperature and non-condensation should be ensured.)					
	Vibration		10-55Hz, 15 minutes sweep and 1.52mm total amplitude, 3 directions, 2h for each					
	Shock		980m/s ² (100G), 6ms, 6 directions, 3 times for each, in non-operation					
Isolation	Withstand Voltage		Between input terminal and case, between input terminal and output terminal, and between output terminal and case: 500VAC (for 1 minute)					
	Isolation Resistance		Between input terminal and case, between input terminal and output terminal, and between output terminal and case: 500VDC, 50MΩ min					
Standards	Safety Standards		UL60950-1, CSA C22.2 No.60950-1 (C-UL), EN60950-1 (NEMKO)					
Mechanical	Weight (typ)	g	10					
	Size (W x H x D)	mm	DIP: 35.56 x 8.5 x 22.6 / SMD: 35.56 x 8.8 x 22.6					

Note: "x" in model names is to be replaced by a symbol which represents the terminal configuration (F: DIP/R: SMD) for actual model names.

Note: With nominal input/output voltage, maximum output current, and Ta=25°C, if not specified separately.

Note: For 12V/ ± 12V models, output power can be set to 15V/ ± 15V by connecting the output adjustment terminal TRM to -Vout.

Note: For ± 12V model, output voltage can be set to 24V or 30V single output by making the COM terminal open.

(*1) With nominal input voltage, maximum output current, and Ta=25°C.

(*2) The maximum output power value is between -40°C and +50°C. For use in outside this temperature range, derating is needed.

(*3) In balanced load for dual outputs ("balanced load" means a condition where the +output and -output of load current are equal).

(*4) Output voltage includes input change, load change (balanced load), and temperature change.

(*5) In 50MHz, Ta=25°C.

(*6) Output current restriction method. Automatically resumes when the causes are removed. Never operate the unit under output-short or overload conditions for over 30 seconds.

ITEMS/UNITS		MODEL	CC10-1203Sx-E	CC10-1205Sx-E	CC10-1212Sx-E		CC10-1212Dx-E	
Input	Nominal Voltage	V	DC12					
	Voltage Range	V	DC9.0-18					
	Efficiency (typ) (*1)	%	84	86	88		86	
	Current (typ) (*1)	A	0.318	0.969	1.136		1.047	
Output	Nominal Voltage	VDC	3.3	5	12	15	± 12	± 15
	Maximum Current	A	2.500	2.000	1000	800	450	360
	Maximum Power (*2)	W	8.25	10	12		10.8	
	Maximum Line Regulation (Within input voltage range)	mV	20		40		80	
	Maximum Load Regulation (0-100% load) (*3)	mV	40		100		600	
	Temperature Coefficient (Ambient temperature -40°C to +50°C)		80mV		200mV		300mV	
	Max Power Total Regulation (max) (*4)	%	± 3					
	Maximum Ripple & Noise (typ/max) (*5)	mVp-p	40/120			30/120		
	Voltage Adjustable Range	VDC	3.15-3.6	4.75-6.0	11.4-15.0		± 11.4- ± 15.0	
	Function	Over Current Protection (*6)		Available				
Over Voltage Protection			Not available					
Remote ON/OFF Control			Available					
Environment	Operating Temperature	°C	-40 to +85					
	Storage Temperature	°C	-40 to +85					
	Operating Humidity	% RH	5-95 (the conditions of maximum 38°C in wet bulb temperature and non-condensation should be ensured.)					
	Storage Humidity	% RH	5-95 (the conditions of maximum 38°C in wet bulb temperature and non-condensation should be ensured.)					
	Vibration		10-55Hz, 15 minutes sweep and 1.52mm total amplitude, 3 directions, 2h for each					
	Shock		980m/s ² (100G), 6ms, 6 directions, 3 times for each, in non-operation					
Isolation	Withstand Voltage		Between input terminal and case, between input terminal and output terminal, and between output terminal and case: 500VAC (for 1 minute)					
	Isolation Resistance		Between input terminal and case, between input terminal and output terminal, and between output terminal and case: 500VDC, 50MΩ min					
Standards	Safety Standards		UL60950-1, CSA C22.2 No.60950-1 (C-UL), EN60950-1 (NEMKO)					
Mechanical	Weight (typ)	g	10					
	Size (W x H x D)	mm	DIP: 35.56 x 8.5 x 22.6 / SMD: 35.56 x 8.8 x 22.6					

Note: "x" in model names is to be replaced by a symbol which represents the terminal configuration (F: DIP/R: SMD) for actual model names.

Note: With nominal input/output voltage, maximum output current, and Ta=25°C, if not specified separately.

Note: For 12V/ ± 12V models, output power can be set to 15V/ ± 15V by connecting the output adjustment terminal TRM to -Vout.

Note: For ± 12V model, output voltage can be set to 24V or 30V single output by making the COM terminal open.

(*1) With nominal input voltage, maximum output current, and Ta=25°C.

(*2) The maximum output power value is between -40°C and +50°C. For use in outside this temperature range, derating is needed.

(*3) In balanced load for dual outputs ("balanced load" means a condition where the +output and -output of load current are equal).

(*4) Output voltage includes input change, load change (balanced load), and temperature change.

(*5) In 50MHz, Ta=25°C.

(*6) Output current restriction method. Automatically resumes when the causes are removed. Never operate the unit under output-short or overload conditions for over 30 seconds.

ITEMS/UNITS		MODEL	CC10-2403Sx-E	CC10-2405Sx-E	CC10-2412Sx-E		CC10-2412Dx-E	
Input	Nominal Voltage	V	DC24					
	Voltage Range	V	DC18-36					
	Efficiency (typ) (*1)	%	84	86	87		86	
	Current (typ) (*1)	A	0.409	0.484	0.575		0.523	
Output	Nominal Voltage	VDC	3.3	5	12	15	± 12	± 15
	Maximum Current	A	2.500	2.000	1.000	0.800	0.450	0.360
	Maximum Power (*2)	W	8.25	10	12		10.8	
	Maximum Line Regulation (Within input voltage range)	mV	20		40		80	
	Maximum Load Regulation (0-100% load) (*3)	mV	40		100		600	
	Temperature Coefficient (Ambient temperature -40°C to +50°C)		80mV		200mV		300mV	
	Max Power Total Regulation (max) (*4)	%			± 3		± 5	
	Maximum Ripple & Noise (typ/max) (*5)	mVp-p	40/120				30/120	
	Voltage Adjustable Range	VDC	3.15-3.6	4.75-6.0	11.4-15.0		± 11.4- ± 15.0	
	Function	Over Current Protection (*6)		Available				
Over Voltage Protection			Not available					
Remote ON/OFF Control			Available					
Environment	Operating Temperature	°C	-40 to +85					
	Storage Temperature	°C	-40 to +85					
	Operating Humidity	% RH	5-95 (the conditions of maximum 38°C in wet bulb temperature and non-condensation should be ensured.)					
	Storage Humidity	% RH	5-95 (the conditions of maximum 38°C in wet bulb temperature and non-condensation should be ensured.)					
	Vibration		10-55Hz, 15 minutes sweep and 1.52mm total amplitude, 3 directions, 2h for each					
	Shock		980m/s ² (100G), 6ms, 6 directions, 3 times for each, in non-operation					
Isolation	Withstand Voltage		Between input terminal and case, between input terminal and output terminal, and between output terminal and case: 500VAC (for 1 minute)					
	Isolation Resistance		Between input terminal and case, between input terminal and output terminal, and between output terminal and case: 500VDC, 50MΩ min					
Standards	Safety Standards		UL60950-1, CSA C22.2 No.60950-1 (C-UL), EN60950-1 (NEMKO)					
Mechanical	Weight (typ)	g	10					
	Size (W x H x D)	mm	DIP: 35.56 x 8.5 x 22.6 / SMD: 35.56 x 8.8 x 22.6					

Note: "x" in model names is to be replaced by a symbol which represents the terminal configuration (F: DIP/R: SMD) for actual model names.

Note: With nominal input/output voltage, maximum output current, and Ta=25°C, if not specified separately.

Note: For 12V/ ± 12V models, output power can be set to 15V/ ± 15V by connecting the output adjustment terminal TRM to -Vout.

Note: For ± 12V model, output voltage can be set to 24V or 30V single output by making the COM terminal open.

(*1) With nominal input voltage, maximum output current, and Ta=25°C.

(*2) The maximum output power value is between -40°C and +50°C. For use in outside this temperature range, derating is needed.

(*3) In balanced load for dual outputs ("balanced load" means a condition where the +output and -output of load current are equal).

(*4) Output voltage includes input change, load change (balanced load), and temperature change.

(*5) In 50MHz, Ta=25°C.

(*6) Output current restriction method. Automatically resumes when the causes are removed. Never operate the unit under output-short or overload conditions for over 30 seconds.

ITEMS/UNITS		MODEL	CC10-4803Sx-E	CC10-4805Sx-E	CC10-4812Sx-E		CC10-4812Dx-E	
Input	Nominal Voltage	V	DC48					
	Voltage Range	V	DC36-76					
	Efficiency (typ) (*1)	%	84	86	88		86	
	Current (typ) (*1)	A	0.205	0.242	0.284		0.262	
Output	Nominal Voltage	VDC	3.3	5	12	15	± 12	± 15
	Maximum Current	A	2.500	2.000	1.000	0.800	0.450	0.360
	Maximum Power (*2)	W	8.25	10	12		10.8	
	Maximum Line Regulation (Within input voltage range)	mV	20		40		80	
	Maximum Load Regulation (0-100% load) (*3)	mV	40		100		600	
	Temperature Coefficient (Ambient temperature -40°C to +50°C)		80mV		200mV		300mV	
	Max Power Total Regulation (max) (*4)	%			± 3		± 5	
	Maximum Ripple & Noise (typ/max) (*5)	mVp-p	40/120				30/120	
	Voltage Adjustable Range	VDC	3.15-3.6	4.75-6.0	11.4-15.0		± 11.4- ± 15.0	
	Function	Over Current Protection (*6)		Available				
Over Voltage Protection			Not available					
Remote ON/OFF Control			Available					
Environment	Operating Temperature	°C	-40 to +85					
	Storage Temperature	°C	-40 to +85					
	Operating Humidity	% RH	5-95 (the conditions of maximum 38°C in wet bulb temperature and non-condensation should be ensured.)					
	Storage Humidity	% RH	5-95 (the conditions of maximum 38°C in wet bulb temperature and non-condensation should be ensured.)					
	Vibration		10-55Hz, 15 minutes sweep and 1.52mm total amplitude, 3 directions, 2h for each					
	Shock		980m/s ² (100G), 6ms, 6 directions, 3 times for each, in non-operation					
Isolation	Withstand Voltage		Between input terminal and case, between input terminal and output terminal, and between output terminal and case: 500VAC (for 1 minute)					
	Isolation Resistance		Between input terminal and case, between input terminal and output terminal, and between output terminal and case: 500VDC, 50MΩ min					
Standards	Safety Standards		UL60950-1, CSA C22.2 No.60950-1 (C-UL), EN60950-1 (NEMKO)					
Mechanical	Weight (typ)	g	10					
	Size (W x H x D)	mm	DIP: 35.56 x 8.5 x 22.6 / SMD: 35.56 x 8.8 x 22.6					

Note: "x" in model names is to be replaced by a symbol which represents the terminal configuration (F: DIP/R: SMD) for actual model names.

Note: With nominal input/output voltage, maximum output current, and Ta=25°C, if not specified separately.

Note: For 12V/ ± 12V models, output power can be set to 15V/ ± 15V by connecting the output adjustment terminal TRM to -Vout.

Note: For ± 12V model, output voltage can be set to 24V or 30V single output by making the COM terminal open.

(*1) With nominal input voltage, maximum output current, and Ta=25°C.

(*2) The maximum output power value is between -40°C and +50°C. For use in outside this temperature range, derating is needed.

(*3) In balanced load for dual outputs ("balanced load" means a condition where the +output and -output of load current are equal).

(*4) Output voltage includes input change, load change (balanced load), and temperature change.

(*5) In 50MHz, Ta=25°C.

(*6) Output current restriction method. Automatically resumes when the causes are removed. Never operate the unit under output-short or overload conditions for over 30 seconds.

Outline Drawing

CC10-xxxxxF-E (DIP type)

Shape/Dimensions

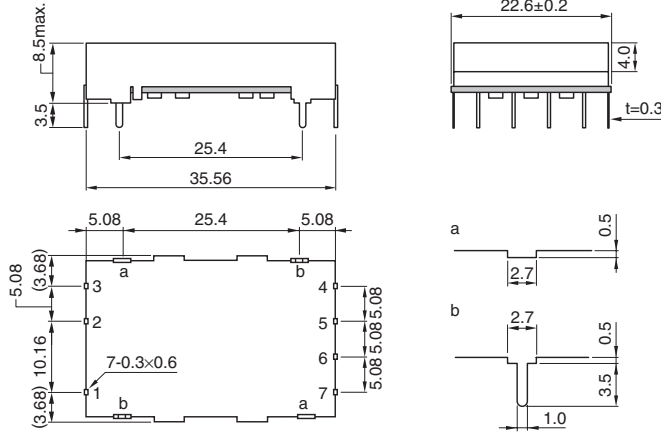

Recommended measurements for mounting board

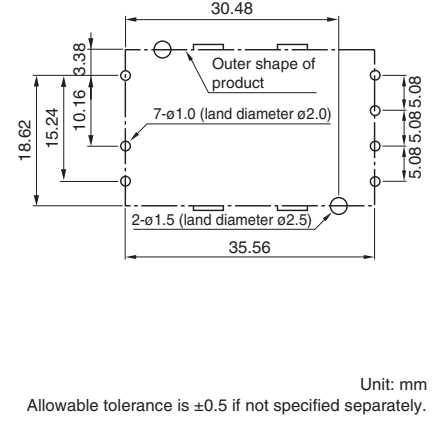

CC10-xxxxxR-E (SMD type)

Shape/Dimensions

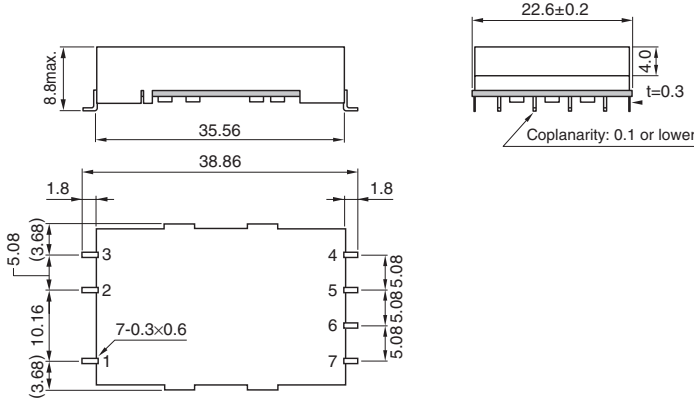

Recommended measurements for mounting board

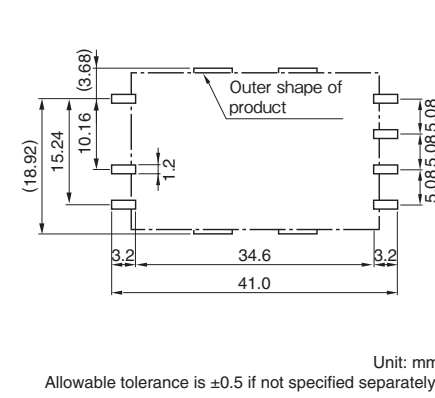

Connection diagram

CC10-xxxxSx-E

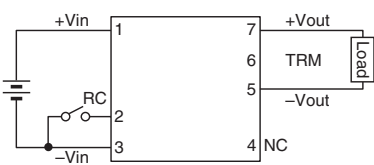

Terminal connections

No.1	+Vin
No.2	RC
No.3	-Vin
No.4	NC
No.5	-Vout
No.6	TRM
No.7	+Vout

CC10-xxxxDx-E

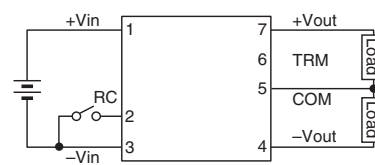

Terminal connections

No.1	+Vin
No.2	RC
No.3	-Vin
No.4	-Vout
No.5	Common out
No.6	TRM
No.7	+Vout

Derating Curve

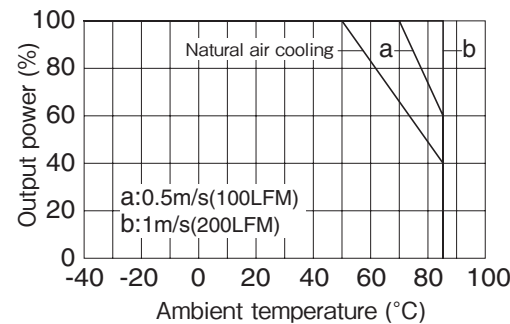

Output power derating by ambient temperature (common specification)

CC15-E Specifications

ITEMS/UNITS		MODEL	CC15-2403Sx-E	CC15-2405Sx-E
Input	Nominal Voltage	V	DC24	
	Voltage Range	V	DC18-36	
	Efficiency (typ) (*1)	%	89	
	Current (typ) (*1)	A	0.695	0.702
Output	Nominal Voltage	VDC	3.3	5
	Maximum Current	A	4.500	3.000
	Maximum Power (*2)	W	14.85	15
	Maximum Line Regulation (Within input voltage range)	mV	65	100
	Maximum Load Regulation (0-100% load)	mV	120	200
	Temperature Coefficient (Ambient temperature -40°C to +50°C)		80mV	
	Max Power Total Regulation (max)(*3)	%	+5/-3	
	Maximum Ripple & Noise (typ/max) (*4)	mVp-p	40/120	
	Voltage Adjustable Range		Not available	
	Function	Over Current Protection (*5)		Available
Over Voltage Protection			Not available	
Remote ON/OFF Control			Available	
Environment	Operating Temperature	°C	-40 to +85	
	Storage Temperature	°C	-40 to +85	
	Operating Humidity	% RH	5-95 (the conditions of maximum 38°C in wet bulb temperature and non-condensation should be ensured.)	
	Storage Humidity	% RH	5-95 (the conditions of maximum 38°C in wet bulb temperature and non-condensation should be ensured.)	
	Vibration		10-55Hz, 15 minutes sweep and 1.52mm total amplitude, 3 directions, 2h for each	
	Shock		980m/s ² (100G), 6ms, 6 directions, 3 times for each, in non-operation	
Isolation	Withstand Voltage		Between input terminal and case, between input terminal and output terminal, and between output terminal and case: 500VAC (for 1 minute)	
	Isolation Resistance		Between input terminal and case, between input terminal and output terminal, and between output terminal and case: 500VDC, 50MΩ min	
Standards	Safety Standards		UL60950-1, CSA C22.2 No.60950-1 (C-UL), EN60950-1 (NEMKO)	
Mechanical	Weight (typ)	g	12.5	
	Size (W x H x D)	mm	DIP: 37.55 x 7.0 x 32.1 / SMD: 37.55 x 7.5 x 32.1	

Note: "x" in model names is to be replaced by a symbol which represents the terminal configuration (F: DIP/R: SMD) for actual model names.

Note: With nominal input/output voltage, maximum output current, and Ta=25°C, if not specified separately.

(*1) With nominal input voltage, maximum output current, and Ta=25°C.

(*2) The maximum output power value is between -40°C and +50°C. For use in outside this temperature range, derating is needed.

(*3) Output voltage includes input change, load change (balanced load), and temperature change.

(*4) In 50MHz, Ta=25°C.

(*5) Latch method Resumes by restarting input or resetting remote on/off.

Outline Drawing

CC15-xxxxxSF-E (DIP type)

Shape/Dimensions

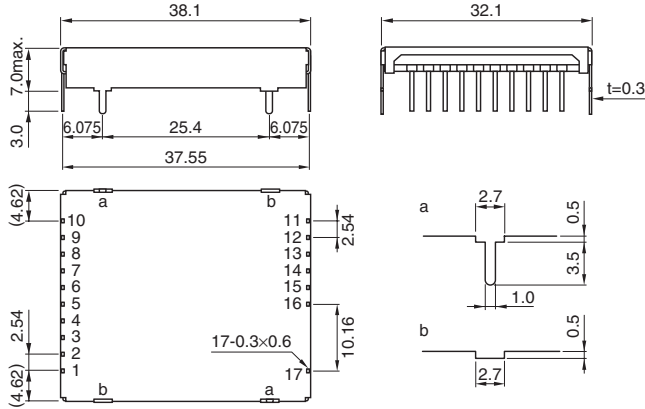

Recommended measurements for mounting board

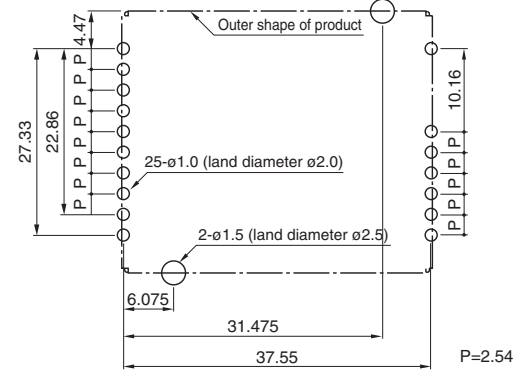

Unit: mm
Allowable tolerance is ± 0.5 if not specified separately.

CC15-xxxxxSR-E (SMD type)

Shape/Dimensions

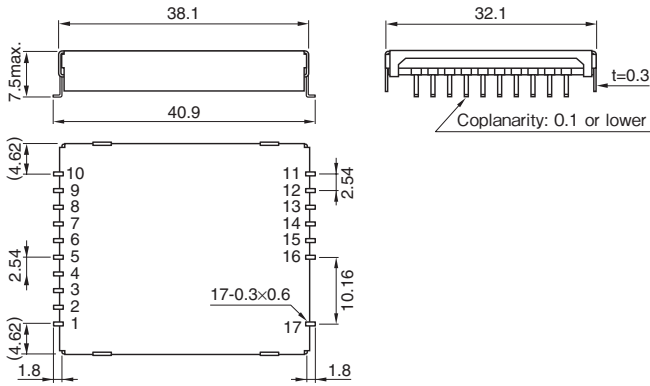

Recommended measurements for mounting board

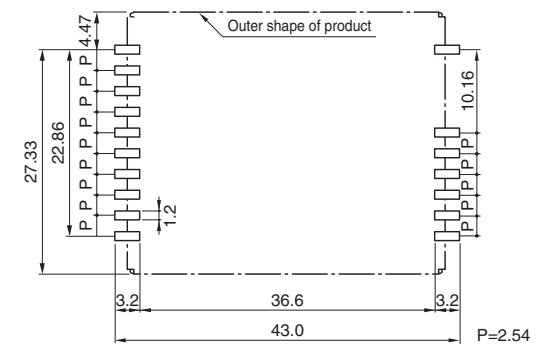

Unit: mm
Allowable tolerance is ± 0.5 if not specified separately.

Connection diagram

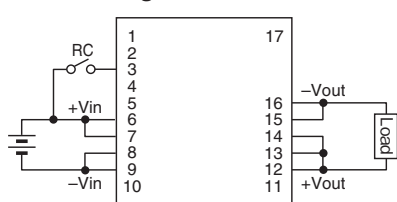

Terminal connections

No.1	NC	No.10	NC
No.2	NC	No.11	NC
No.3	RC	No.12	+Vout
No.4	NC	No.13	+Vout
No.5	NC	No.14	+Vout
No.6	+Vin	No.15	-Vout
No.7	+Vin	No.16	-Vout
No.8	-Vin	No.17	NC
No.9	-Vin		

Derating Curve

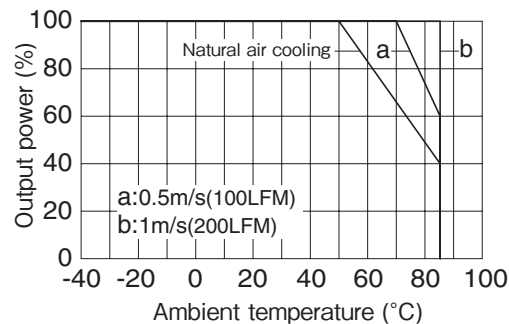

Output power derating by ambient temperature (common specification)

CC25-E Specifications

ITEMS/UNITS		MODEL	CC25-2403Sx-E	CC25-2405Sx-E
Input	Nominal Voltage	V	DC24	
	Voltage Range	V	DC18-36	
	Efficiency (typ) (*1)	%	90	
	Current (typ) (*1)	A	1.146	1.157
Output	Nominal Voltage	VDC	3.3	5
	Maximum Current	A	7.500	5.000
	Maximum Power (*2)	W	24.75	25
	Maximum Line Regulation (Within input voltage range)	mV	65	100
	Maximum Load Regulation (0-100% load)	mV	120	200
	Temperature Coefficient (Ambient temperature -40°C to +50°C)		80mV	
	Max Power Total Regulation (max)(*3)	%	+5/-3	
	Maximum Ripple & Noise (typ/max) (*4)	mVp-p	40/120	
	Voltage Adjustable Range	VDC	Not available	
	Function	Over Current Protection (*5)		Available
Over Voltage Protection			Not available	
Remote ON/OFF Control			Available	
Environment	Operating Temperature	°C	-40 to +85	
	Storage Temperature	°C	-40 to +85	
	Operating Humidity	% RH	5-95 (the conditions of maximum 38°C in wet bulb temperature and non-condensation should be ensured.)	
	Storage Humidity	% RH	5-95 (the conditions of maximum 38°C in wet bulb temperature and non-condensation should be ensured.)	
	Vibration		10-55Hz, 15 minutes sweep and 1.52mm total amplitude, 3 directions, 2h for each	
Isolation	Shock		980m/s ² (100G), 6ms, 3 directions, 3 times for each, in non-operation	
	Withstand Voltage		Between input terminal and case, between input terminal and output terminal, and between output terminal and case: 500VAC (for 1 minute)	
Standards	Isolation Resistance		Between input terminal and case, between input terminal and output terminal, and between output terminal and case: 500VDC, 50MΩ min	
	Safety Standards		UL60950-1, CSA C22.2 No.60950-1 (C-UL), EN60950-1 (NEMKO)	
Mechanical	Weight (typ)	g	20	
	Size (W x H x D)	mm	DIP: 42.65 x 7.0 x 44.9 / SMD: 42.65 x 7.5 x 44.9	

Note: "x" in model names is to be replaced by a symbol which represents the terminal configuration (F: DIP/R: SMD) for actual model names.
 Note: With nominal input/output voltage, maximum output current, and Ta=25°C, if not specified separately.

- (*1) With nominal input voltage, maximum output current, and Ta=25°C.
- (*2) The maximum output power value is between -40°C and +50°C. For use in outside this temperature range, derating is needed.
- (*3) Output voltage includes input change, load change (balanced load), and temperature change.
- (*4) In 50MHz, Ta=25°C.
- (*5) Latch method Resumes by restarting input or resetting remote on/off.

Outline Drawing

CC25-xxxxSF-E (DIP type)

Shape/Dimensions

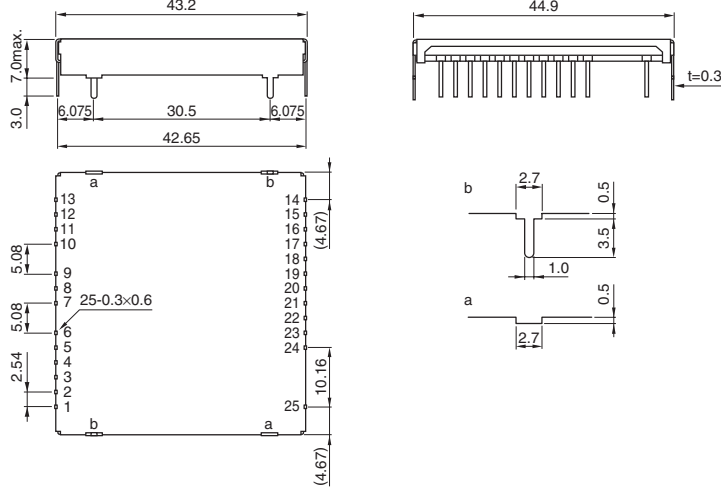

Recommended measurements for mounting board

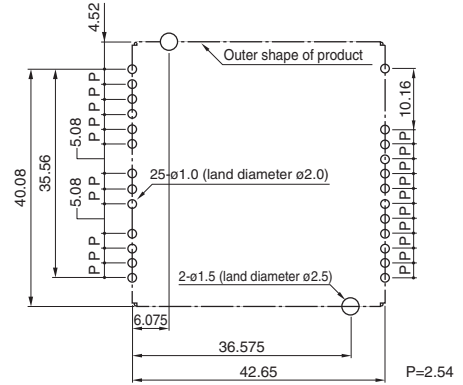

Unit: mm
Allowable tolerance is ±0.5 if not specified separately.

CC25-xxxxSR-E (SMD type)

Shape/Dimensions

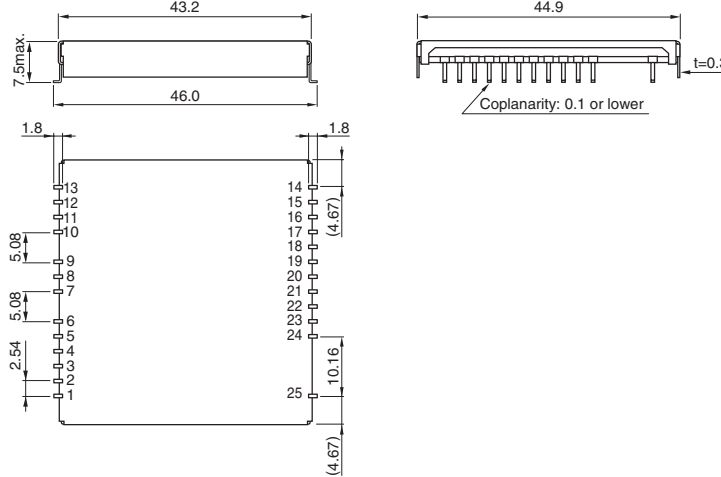

Recommended measurements for mounting board

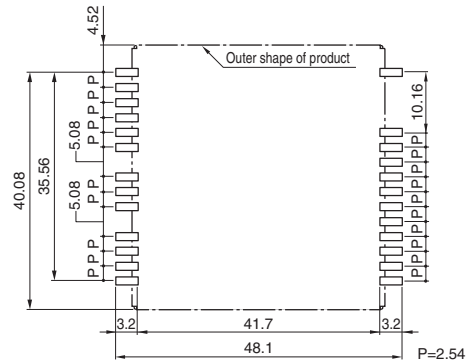

Unit: mm
Allowable tolerance is ±0.5 if not specified separately.

Connection diagram

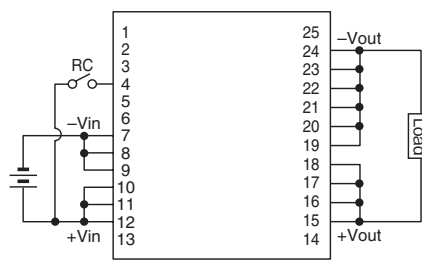

Terminal connections

No.1 NC	No.10 +Vin	No.19 -Vout
No.2 NC	No.11 +Vin	No.20 -Vout
No.3 NC	No.12 +Vin	No.21 -Vout
No.4 RC	No.13 NC	No.22 -Vout
No.5 NC	No.14 NC	No.23 -Vout
No.6 NC	No.15 +Vout	No.24 -Vout
No.7 -Vin	No.16 +Vout	No.25 NC
No.8 -Vin	No.17 +Vout	
No.9 -Vin	No.18 +Vout	

Derating Curve

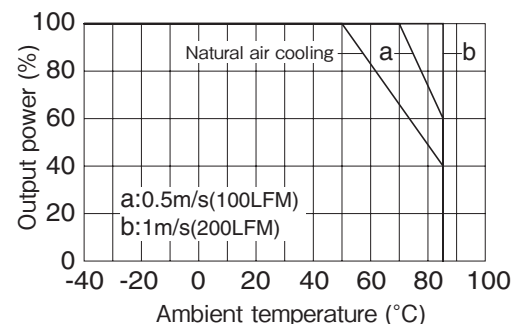

Output power derating by ambient temperature (common specification)

CC-E Instruction Manual

1. Control functions/Protection functions/Connections

1. Remote On/Off terminal (RC)

1.5-10W type

Open collector is recommended as the connection system. Consult us for use with other systems.

Use a transistor with "VCE: Vin or over" and "Ic: 1mA or over".

Output is switched off by setting the RC terminal open, and switched on by setting the RC terminal to LOW (0-0.4V).

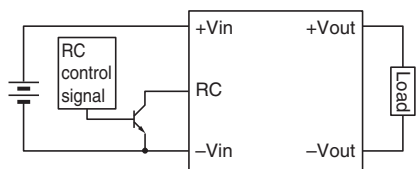

When not using this function (always on), short-circuit between RC terminal and -Vin terminal.

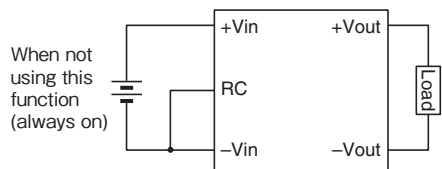

15/25W type

Output is switched on by setting the RC terminal to open, and switched off by setting the RC terminal to HIGH (connecting to Vin terminal).

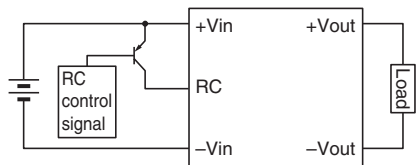

When not using this function (always on), set the RC terminal to open.

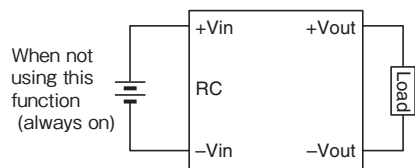

1-2. Output voltage adjusting terminal (TRM) (1.5-10W type)

Output voltage can be set to the values shown in the figure below by connecting the TRM terminal to the -Vout terminal.

When not using this function (always on), set the TRM terminal to open.

Note that when the output voltage is set high by this function, derating of output current is necessary according to the maximum power.

DIP/SMD models

Model name	Open	Connection to -Vout	Fig.
CC*-xx03Sx-E	3.3V	3.6V	1
CC*-xx05Sx-E	5V	6V	1
CC*-xx12Sx-E	12V	15V	1
CC*-xx12Dx-E	±12V	±15V	2

* To be replaced with 1R5(1.5W), 3(3W), 6(6W), or 10(10W) for actual model names.

Fig.1

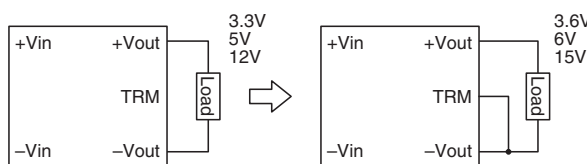
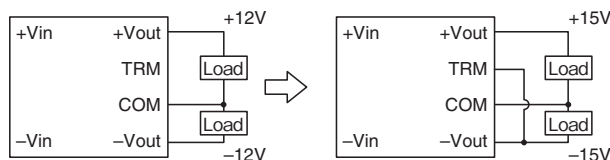

Fig.2



SIP models

Model name	Model name	Connection to -Vout	Fig.
CC3-xx03SS-E	3.3V	3.67V	3
CC3-xx05SS-E	5V	6V	3
CC3-xx12SS-E	12V	15V	3
CC3-xx12DS-E	±12V	±15V	4

Fig.3

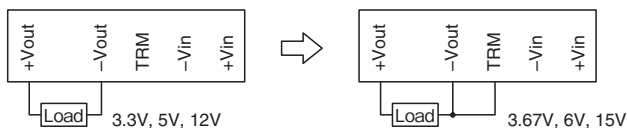
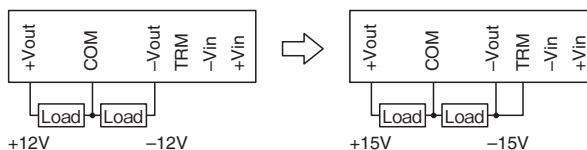

Fig.4



For ±the 12V output model, output voltage can be set to 24V single output by making the COM terminal and TRM terminal open. And output voltage can be set to 30V single output by making the COM terminal open and connecting the TRM terminal to the -Vout terminal.

DIP/SMD models

Model name	COM terminal	TRM terminal	Single output	Fig.
CC*-xx12Dx-E	Open	Open	24V	5
	Open	Connection to -Vout	30V	6

* To be replaced with 1R5(1.5W), 3(3W), 6(6W), or 10(10W) for actual model names.

Fig.5

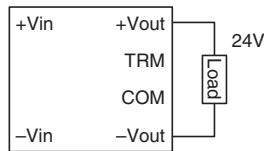
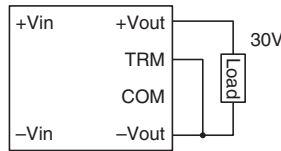

Fig.6



SIP models

Model name	COM terminal	TRM terminal	Single output	Fig.
CC3-xx12DS-E	Open	Open	24V	7
	Open	Connection to -Vout	30V	8

Fig.7

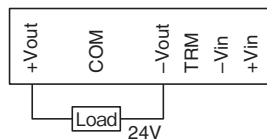
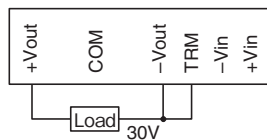

Fig.8



1-3. Output voltage adjusting function (adding external resistance) (1.5-10W type)

Output voltage can be varied in the range shown in the figure below by connecting a resistance (Ra, Rb) between the TRM terminal and the -Vout terminal or between the TRM terminal and +Vout terminal.

Note that when the output voltage is set high, derating of output current is necessary according to the maximum power.

DIP/SMD models

Model name	Connection between -Vout and Ra	Fig.	Connection between +Vout and Rb	Fig.
CC*-xx03Sx-E	3.3 to 3.6V*1	9	3.15 to 3.3V*5	10
CC*-xx05Sx-E	5 to 6V*2	9	4.75 to 5V*6	10
CC*-xx12Sx-E	12 to 15V*3	9	11.4 to 12V*7	10
CC*-xx12Dx-E	±12 to ±15V*4	11	±11.4 to ±12V*8	12

* To be replaced with 1R5(1.5W), 3(3W), 6(6W), or 10(10W) for actual model names.

Calculating output voltage Vout (V) from connected resistance Ra, Rb (kΩ)

Adding a resistance Ra between TRM terminal and -Vout terminal, to set the output voltage high

- *1 Vout = 3.3 + 9.59/(32+Ra)
- *2 Vout = 5.01 + 17.64/(17.8+Ra)
- *3 Vout = 12.01 + 50.53/(16.9+Ra)
- *4 Vout = 12.02 + 53.55/(18+Ra)

Adding a resistance Rb between TRM terminal and +Vout terminal, to set the output voltage low

- *5 Vout = 3.3 - 15.53/(39.6+Rb) [Rb ≥ 62]
- *6 Vout = 5.01 - 52.55/(31.8+Rb) [Rb ≥ 160]
- *7 Vout = 12.01 - 431.1/(57+Rb) [Rb ≥ 620]
- *8 Vout = 12.02 - 968.5/(103+Rb) [Rb ≥ 1500]

Calculating connected resistance Ra, Rb (kΩ) from set output voltage Vout (V)

Adding a resistance Ra between TRM terminal and -Vout terminal, to set the output voltage high

- *1 Ra = 9.59/(Vout-3.3) - 32
- *2 Ra = 17.64/(Vout-5.01) - 17.8
- *3 Ra = 50.53/(Vout-12.01) - 16.9
- *4 Ra = 53.55/(Vout-12.02) - 18

Adding a resistance Rb between TRM terminal and +Vout terminal, to set the output voltage low

- *5 Rb = 15.53/(3.3-Vout) - 39.6
- *6 Rb = 52.55/(5.01-Vout) - 31.8
- *7 Rb = 431.1/(12.01-Vout) - 57
- *8 Rb = 968.5/(12.02-Vout) - 103

Fig.9

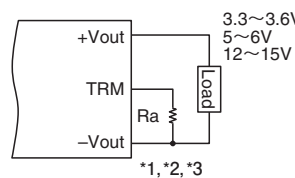

*1, *2, *3

Fig.10

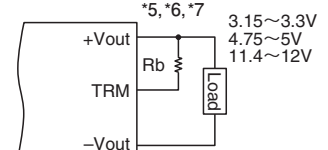

*5, *6, *7

Fig.11

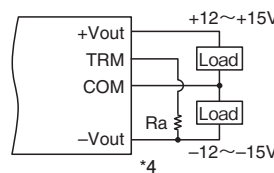

*4

Fig.12

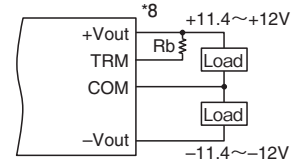

*8

SIP models

Model name	Connection between -Vout and Ra	Fig.	Connection between +Vout and Rb	Fig.
CC3-xx03SS-E	3.3 to 3.6V*1	13	3.15 to 3.3V*5	14
CC3-xx05SS-E	5 to 6V*2	13	4.75 to 5V*6	14
CC3-xx12SS-E	12 to 15V*3	13	11.4 to 12V*7	14
CC3-xx12DS-E	±12 to ±15V*4	15	±11.4 to ±12V*8	16

* To be replaced with 1R5(1.5W), 3(3W), 6(6W), or 10(10W) for actual model names.

Calculating output voltage Vout (V) from connected resistance Ra, Rb (kΩ)

Adding a resistance Ra between TRM terminal and -Vout terminal, to set the output voltage high

- *1 Vout = 3.3 + 1.04/(2.83+Ra)
- *2 Vout = 5 + 12.75/(12.69+Ra)
- *3 Vout = 12 + 48.4/(16.18+Ra)
- *4 Vout = 12 + 54.7/(18+Ra)

Adding a resistance Rb between TRM terminal and +Vout terminal, to set the output voltage low

- *5 Vout = 3.3 - 1.69/(3.66+Rb) [Rb ≥ 7.6]
- *6 Vout = 5 - 12.78/(17.79+Rb) [Rb ≥ 33.3]
- *7 Vout = 12 - 184.1/(35.54+Rb) [Rb ≥ 271.3]
- *8 Vout = 12 - 470.3/(61.75+Rb) [Rb ≥ 722.1]

Calculating connected resistance Ra, Rb (kΩ) from set output voltage Vout (V)

Adding a resistance Ra between TRM terminal and -Vout terminal, to set the output voltage high

- *1 $R_a = 1.04 / (V_{out} - 3.3) - 2.83$
- *2 $R_a = 12.75 / (V_{out} - 5) - 12.69$
- *3 $R_a = 48.4 / (V_{out} - 12) - 16.18$
- *4 $R_a = 54.7 / (V_{out} - 12) - 18$

Adding a resistance Rb between TRM terminal and +Vout terminal, to set the output voltage low

- *5 $R_b = 1.69 / (3.3 - V_{out}) - 3.66$
- *6 $R_b = 12.78 / (5 - V_{out}) - 17.79$
- *7 $R_b = 184.1 / (12 - V_{out}) - 35.54$
- *8 $R_b = 470.3 / (12 - V_{out}) - 61.75$

Fig.13

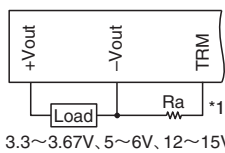

Fig.14

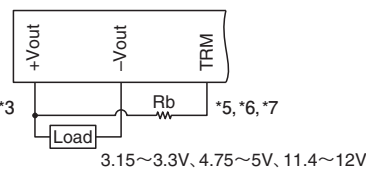

Fig.15

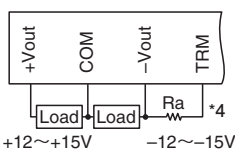
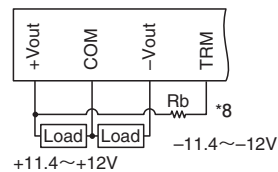

Fig.16



1-4. Over current protection

1.5-10W type

An over current protection circuit is incorporated in the model, and if over current occurs, the output voltage is lowered. By removing the over current and shorted conditions, the output voltage automatically resumes. Note that if the over current status continues for 30 seconds or over, the internal elements of the converter may be deteriorated or damaged. The current value, from which it is judged as an over current, is not to be lower than the nominal current value. If the output voltage does not resume even after removing the over current conditions and any causes, turn off the power or remote control once, and then restart it.

15/25W type

An over current protection circuit is incorporated in the model, and if over current occurs, the output voltage is lowered and the converter is stopped and latched. The output voltage does not automatically resume even after removing the over current and shorted conditions.

To resume output voltage, restart input or reset remote on/off.

The current value, from which it is judged as an over current, is not to be lower than the nominal current value.

1-5. Over voltage protection

An over voltage protection function is not incorporated in the model. Be careful if an external voltage over the nominal voltage is applied, damage may be caused.

1-6. Low input voltage protection

This series is equipped with the low input voltage protection in order to prevent malfunction due to low input voltage. The converter stops operation if the input voltage become lower than the set voltage. The set ranges are shown in the table below.

Model name	Input voltage range	Voltage range set for protection circuit
CC [®] -05xxxx-E	4.5 to 9V	3 to 4.5V
CC [®] -12xxxx-E	9 to 18V	6 to 9V
CC [®] -24xxxx-E	18 to 36V	13 to 18V
CC [®] -48xxxx-E	36 to 76V	27 to 36V
CC15-24xxSx-E	18 to 36V	12 to 18V
CC25-24xxSx-E	18 to 36V	12 to 18V

* To be replaced with 1R5(1.5W), 3(3W), 6(6W), or 10(10W) for actual model names.

1-7. Insulation withstand voltage

The insulation withstand voltage between input and output, and between terminal and case, is AC500V.

1-8. Series/Parallel connections

Series connection

Serial connection is applicable by wiring as shown in the figure below (left). If output voltage is not generated by this connection, connect a Schottky diode in which the forward voltage is possibly low.

Also note that the Schottky diode should have a reverse voltage that is twice or over the value of the voltage between +Vout and -Vout.

And the output current should be the same or lower than the nominal current value, whichever is smaller in the converters.

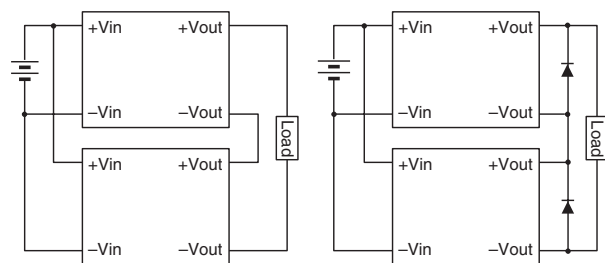

Parallel connection

Parallel connection is not applicable.

2. Noise reduction methods

2-1. Ripple noise measurement method

The measured value of the converter noise may differ depending on the measurement method. Measurement should be conducted in a position close to the output terminal. When connecting a probe, do not allow a loop to be configured in order not to pick up flux.

As well, note that the spike voltage greatly differs depending on the ripple voltmeter and frequency band of the oscilloscope.

Our noise measurement is conducted by the wiring shown in the figure below and in the frequency band of 50MHz.

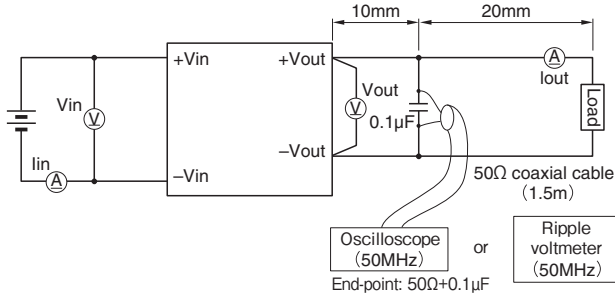

2-2. Input ripple noise

This series is equipped with a built-in capacitor for input. However, by connecting a capacitor with around 10µF, input ripple noise and input return noise can be reduced.

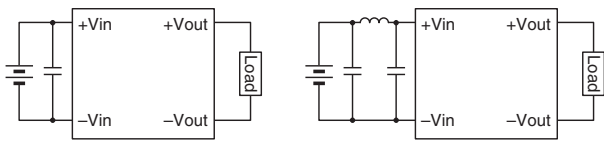

When the distance to the input of the converter from the input power supply is long, attach a capacitor as close as possible to the input terminal.

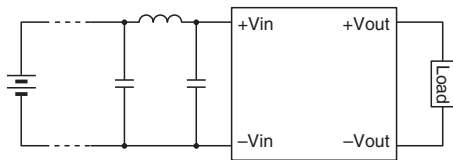

When the distance to the input of the converter from the input power supply is long, the impedance of the input line can become high, causing high spike noise.

In this case, it is recommended to connect a capacitor as close as possible to the input of the DC-DC converter.

2-3. Output ripple & noise

To reduce Output ripple & noise, connect a capacitor to the output of the converter. In addition, reduction can be enhanced if a π type filter is incorporated as shown in the figure below. In this case, use of a coil with around 100µH is recommended.

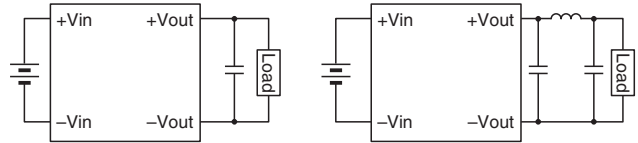

When the distance to the load from the output of the converter is long, connect the capacitor as close as possible to the load.

To reduce output spike noise, connect a ceramic capacitor with around 1µF to the output of the converter.

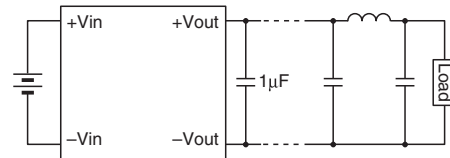

2-4. Capacity of external capacitor connected to output

Note that if a capacitor with capacity over the value shown in the table below is connected to the output, or several capacitors with low impedance are connected in parallel, operation of the converter may become unstable.

Model name	Electrostatic capacitance (µF) max.
CC1R5-xx03Sx-E	100
CC1R5-xx05Sx-E	100
CC1R5-xx12Sx-E	47
CC1R5-xx12Dx-E	22
CC3-xx03Sx-E	220
CC3-xx05Sx-E	220
CC3-xx12Sx-E	100
CC3-xx12Dx-E	47
CC6-xx03Sx-E	470
CC6-xx05Sx-E	470
CC6-xx12Sx-E	220
CC6-xx12Dx-E	100
CC10-xx03Sx-E	470
CC10-xx05Sx-E	470
CC10-xx12Sx-E	220
CC10-xx12Dx-E	100
CC15-24xxSx-E	470
CC25-24xxSx-E	470

2-5. Common mode noise

For products other than with 10W, capacitors are not connected between the primary GND and the secondary GND. To reduce common mode noise, connect a capacitor with around 1000pF between the primary GND and the secondary GND, as shown in the figure below.

In this case, note that if the capacitor that is connected is too large, coupling capacitance between input and output becomes large.

Also be careful about the withstand voltage of the capacitor (500V or over is desirable with consideration of the insulation withstand voltage).

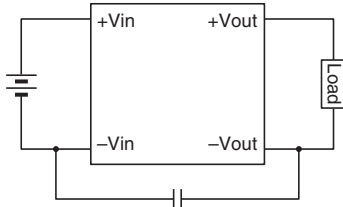

For products with 10W, capacitors with 1000pF are internally connected between primary and secondary.

2-6. Radiation noise

Radiation noise of the converter can be reduced by connecting the case terminal to the input or output GND terminal. The effectiveness varies depending on the device. Check it on the actual device.

Regarding wiring, use GND line and solid pattern for the bottom of the converter as much as possible.

- SMD models are not equipped with case terminals.

3. Soldering conditions/Cleaning conditions

3-1. Soldering conditions

●Soldering conditions
DIP models / SIP models

Observe the following conditions in soldering board.

Solder dip	260°C, 10s max.
Soldering copper	380°C, 3s max.

SMD models

Lead-free soldering / High-temperature reflow process

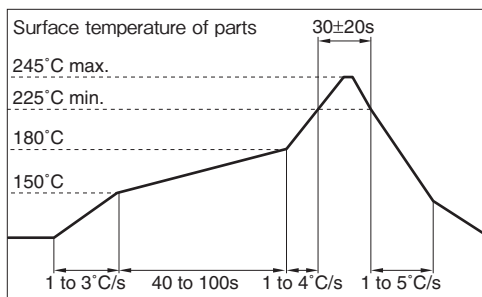

3-2. Cleaning method

Board cleaning after soldering is not recommended. However, the cleaning fluids and conditions shown in the table below have been tested and proved to have no problem. These fluids and conditions can be used. Consult us for using cleaning fluids other than those shown below.

Cleaning fluids and test conditions

Cleanthrough 750H

- (1) Cleaning (shaking) at 60°C for 4 minutes
- (2) Rinsing (shaking in water) at 60°C for 4 minutes
- (3) Rinsing (shaking in water) at ordinary temperature - 40°C for 4 minutes
- (4) Drying at 70°C for 6 minutes

Pine alpha ST100S

- (1) Cleaning (shaking) at 60°C for 5 minutes
- (2) Rinsing (shaking in water) at 30°C for 3 minutes
- (3) Drying at 70°C for 6 minutes

Terpene Cleaner EC-7R

- (1) Cleaning (shaking) at 60°C for 5 minutes
- (2) Rinsing (shaking in IPA) at 30°C for 10 minutes
- (3) Drying at 70°C for 6 minutes

Isopropyl alcohol

- (1) Ultrasonic waves at 60°C for 1 minute
- (2) Cool bath cleaning R.T. for 1 minute
- (3) Vapor cleaning at 83°C for 1 minutes

Asahiklin AK-225AES

- (1) Ultrasonic waves at 50°C for 2 minutes
- (2) Cool bath cleaning R.T. for 2 minutes