

## RT7285CGJ6 Evaluation Board

### *Purpose*

The RT7285C is a synchronous step-down converter with Advanced Constant On-Time (ACOT™) mode control. It can deliver up to 1.5A output current from a wide input voltage range of 4.3V to 18V. This document explains the function and use of the RT7285C evaluation board (EVB) and provides information to enable operation and modification of the evaluation board and circuit to suit individual requirements.

## Table of Contents

PURPOSE.....	1
INTRODUCTION.....	2
KEY PERFORMANCE SUMMARY TABLE.....	2
BENCH TEST SETUP CONDITIONS.....	3
SCHEMATIC, BILL OF MATERIALS AND BOARD LAYOUT.....	5
MORE INFORMATION.....	10
IMPORTANT NOTICE FOR RICHTEK REFERENCE DESIGNS.....	10

## Introduction

### General Product Information

The RT7285C is a synchronous step-down converter with Advanced Constant On-Time (ACOT™) mode control. The ACOT™ provides a very fast transient response with few external components. The low impedance internal MOSFET supports high efficiency operation with wide input voltage range from 4.3V to 18V. The proprietary circuit of the RT7285C enables to support all ceramic capacitors. The output voltage can be adjusted between 0.6V and 8V. The RT7285C also provides output under voltage protection and thermal shutdown protection. The low current (<4μA) shutdown mode provides output disconnection, enabling easy power management in battery-powered systems. The RT7285C is available in TSOT-23-6 package.

### Product Feature

- ±1.5% High Accuracy Feedback Voltage
- 4.3V to 18V Input Voltage Range
- 1.5A Output Current
- Integrated N-MOSFET Switches
- ACOT™ mode control
- Fixed Frequency Operation : 500kHz
- Output Adjustable from 0.6V to 8V
- Up to 95% Efficiency
- Fast Transient Response
- Stable with Low-ESR Ceramic Output Capacitors
- Cycle-by-Cycle Over Current Protection
- Input Under Voltage Lockout
- Output Under Voltage Protection
- Thermal Shutdown Protection
- RoHS Compliant and Halogen Free

### Key Performance Summary Table

Key Features	Evaluation Board Number: PCB007_V1
Default Input Voltage	12V
Max Output Current	1.5A
Default Output Voltage	1.2V
Default Marking & Package Type	RT7285CGJ6, TSOT-23-6
Operation Frequency	Steady 500kHz at all loads
Other Key Features	ACOT™ for Fast Transient Response
Protection	Output Under-Voltage Protection (hiccup mode): Cycle-by-cycle Current Limit Thermal Shutdown

## Bench Test Setup Conditions

### Headers Description and Placement

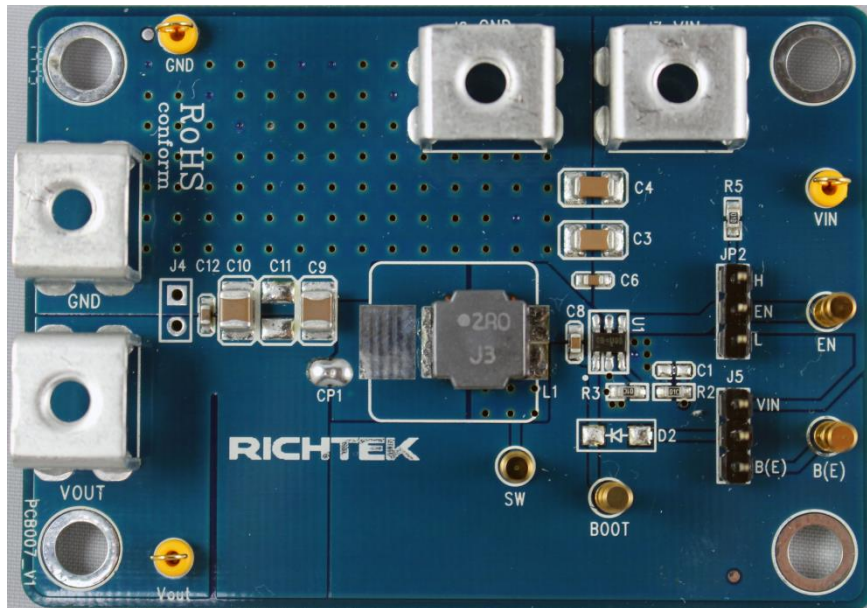

Please carefully inspect the EVB IC and external components, comparing them to the following Bill of Materials, to ensure that all components are installed and undamaged. If any components are missing or damaged during transportation, please contact the distributor or send e-mail to [evb\\_service@richtek.com](mailto:evb_service@richtek.com)

### Test Points

The EVB is provided with the test points and pin names listed in the table below.

Test point/ Pin name	Signal	Comment (expected waveforms or voltage levels on test points)
<b>VIN</b>	Input voltage	Input voltage range= 4.3V to 18V
<b>VOUT</b>	Output voltage	Default output voltage = 1.2V Output voltage range= 0.6V to 8V (see " Output Voltage Setting" section for changing output voltage level)
<b>SW</b>	Switching node test point	SW waveform
<b>EN</b>	Enable test point	Enable signal. Drive EN or install a shorting block on Jumper JP2 to enable operation or disable operation.
<b>JP2</b>	Chip enable control	Install jumper or drive EN directly to enable or disable operation
<b>BOOT</b>	Boot strap supply test point	Floating supply voltage for the high-side N-MOSFET switch
<b>GND</b>	Ground	Ground

### Power-up & Measurement Procedure

1. Apply a 12V nominal input power supply ( $4.3V < V_{IN} < 18V$ ) to the VIN and GND terminals.
2. The EN voltage is pulled to logic high by R5 (100kΩ to VIN) to enable operation. Drive EN high (>1.5V) to enable operation or low (<0.4V) to disable operation.
3. Verify the output voltage (approximately 1.2V) between VOUT and GND.
4. Connect an external load up to 1.5A to the VOUT and GND terminals and verify the output voltage and current.

**Output Voltage Setting**

Set the output voltage with the resistive divider (R2, R3) between VOUT and GND with the midpoint connected to FB. The output is set by the following formula:

$$V_{OUT} = 0.6 \times \left(1 + \frac{R2}{R3}\right)$$

The installed VOUT capacitors (C9, C10) are 22μF, 16V X5R ceramic types. Do not exceed their operating voltage range and consider their voltage coefficient (capacitance vs. bias voltage) and ensure that the capacitance is sufficient to maintain stability and provide sufficient transient response for your application. This can be verified by checking the output transient response as described in the RT7285C IC datasheet.

**Schematic, Bill of Materials & Board Layout**

**EVB Schematic Diagram**

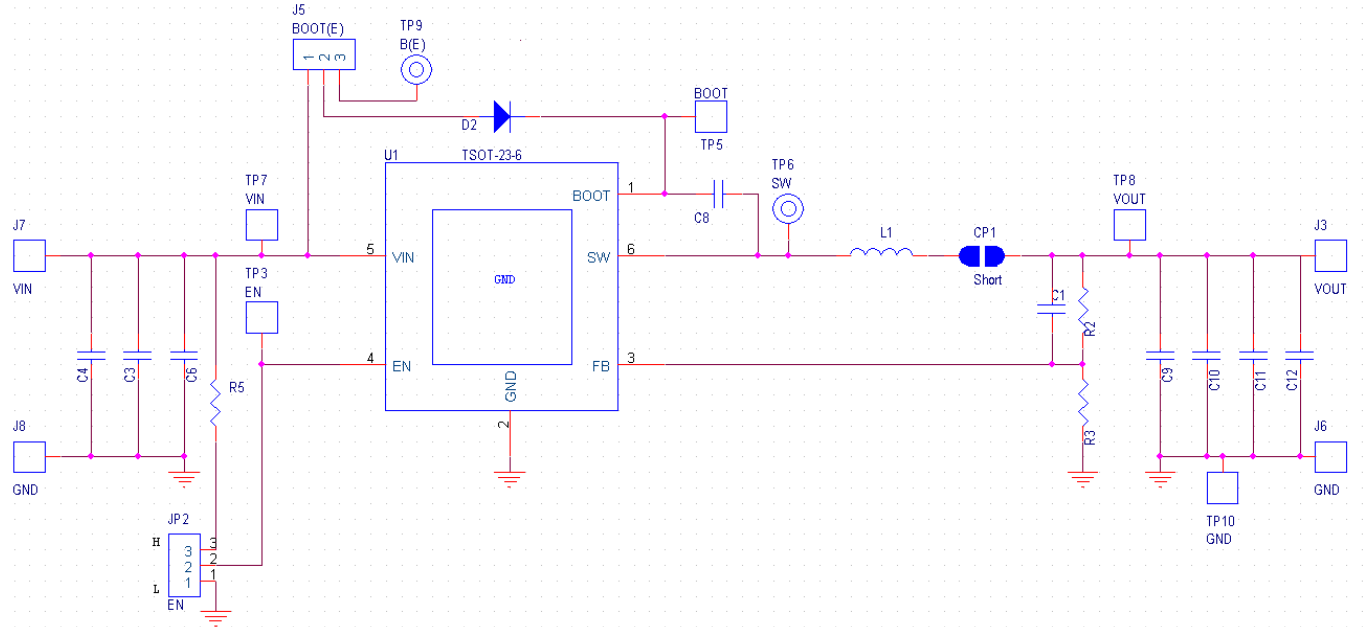

C3, C4: 10 $\mu$ F/50V/X5R, 1206, TDK C3216X5R1H106K

C9, C10: 22 $\mu$ F/16V/X5R, 1210, Murata GRM32ER61C226K

L1: 2 $\mu$ H TAIYO YUDEN NR8040T2R0N, DCR=9m $\Omega$

**Bill of Materials**

Reference	Qty	Part number	Description	Package	Manufacture
<b>U1</b>	1	RT7285CGJ6	DC-DC Converter	TSOT-23-6 (FC)	RICHTEK
<b>C3, C4</b>	2	C3216X5R1H106K160AB	10 $\mu$ F/ $\pm$ 10%/50V/X5R Ceramic Capacitor	1206	TDK
<b>C9, C10</b>	2	GRM32ER61C226KE20#	22 $\mu$ F/ $\pm$ 10%/16V/X5R Ceramic Capacitor	1210	Murata
<b>C6, C8, C12</b>	3	C1608X7R1H104K080AA	0.1 $\mu$ F/ $\pm$ 10%/50V/X7R Ceramic Capacitor	0603	TDK
<b>C1, C11, D2</b>	0		Not Installed	0603	
<b>L1</b>	1	NR8040T2R0N	2.0 $\mu$ H/7.4A/ $\pm$ 30%, DCR=9m $\Omega$ , Inductor	8mmx8mmx4mm	TAIYO YUDEN
<b>R2</b>	1		10k $\Omega$ / $\pm$ 1%, Resistor	0603	
<b>R3</b>	1		10k $\Omega$ / $\pm$ 1%, Resistor	0603	
<b>R5</b>	1		100k $\Omega$ / $\pm$ 1%, Resistor	0603	
<b>CP1</b>	1		Short		
<b>JP2, J5</b>	2		3-Pin Header		
<b>GP</b>	4	EN, B( E), BOOT, SW	Golden Pin		
<b>TP</b>	3	Vout, GND, VIN	Test Pin		
<b>J3, J6, J7, J8</b>	4	VIN, VOUT, GND, GND	Test Pin		

**EVB Layout**

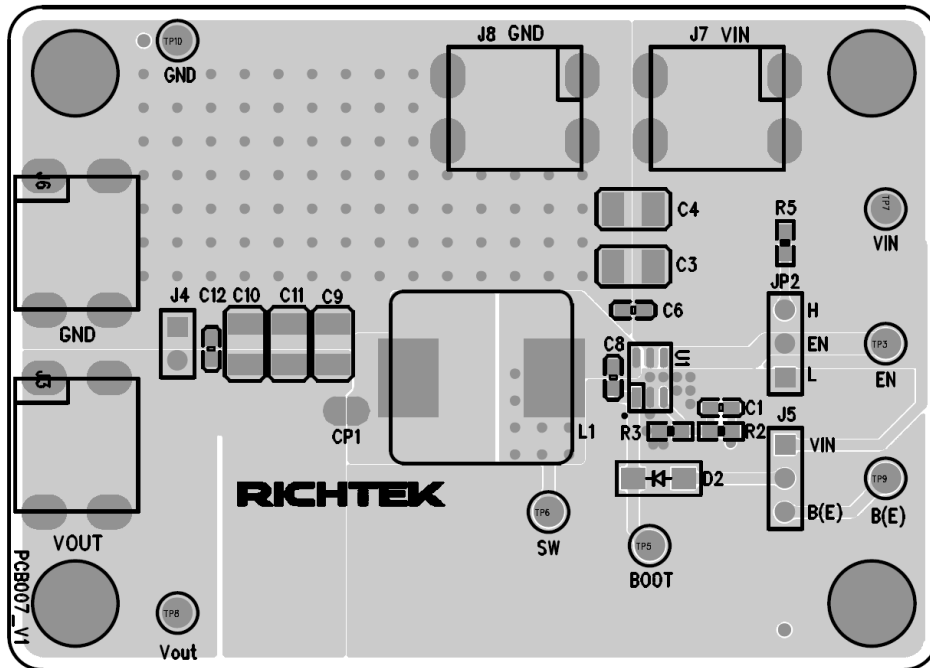

Top View (1<sup>st</sup> layer)

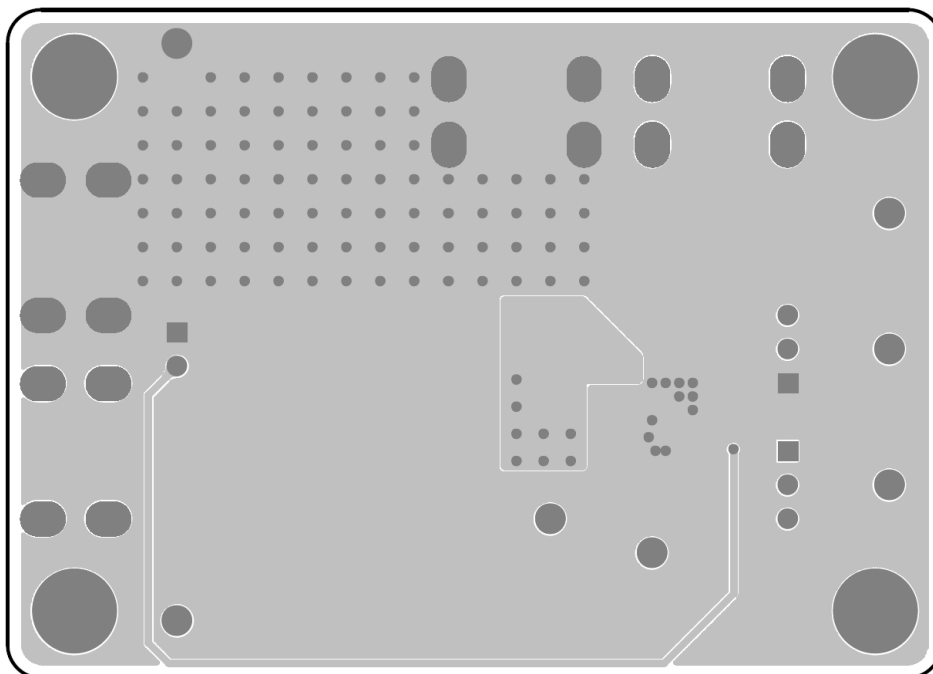

Bottom View (4<sup>th</sup> Layer)

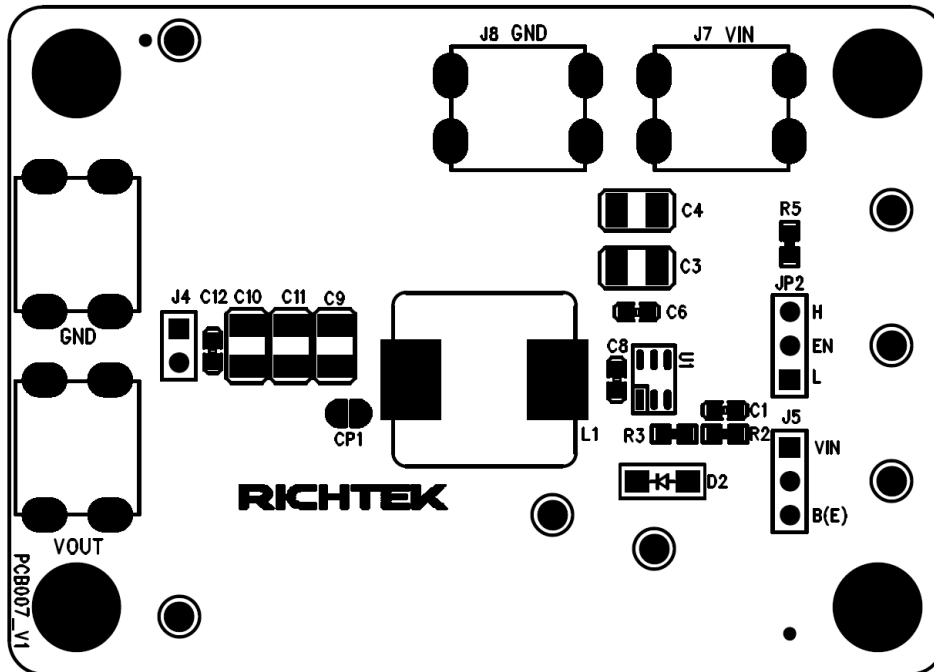

Component Placement Guide—Component Side (1<sup>st</sup> layer)

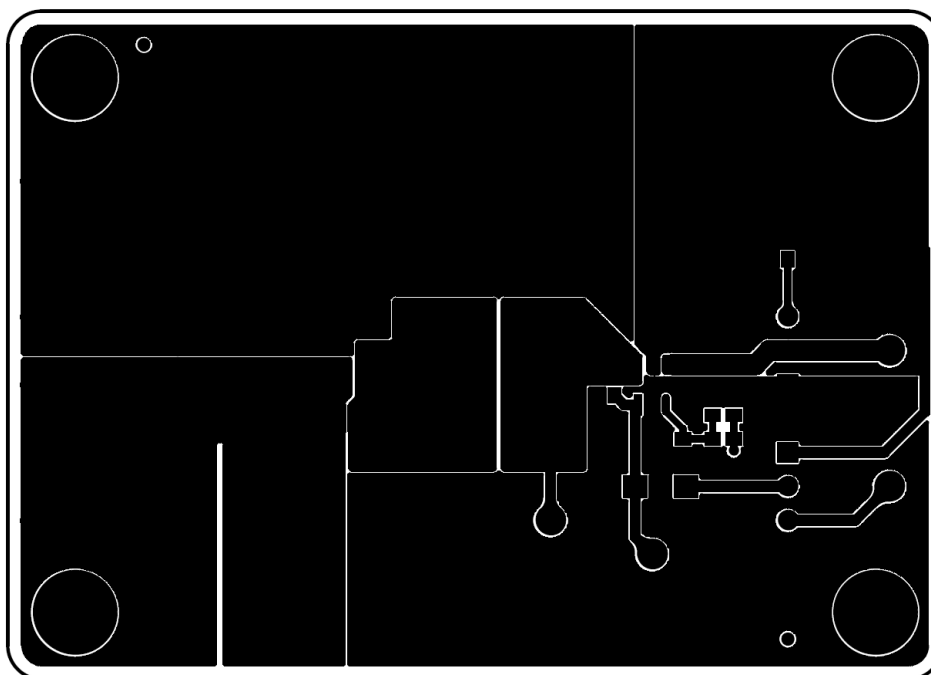

PCB Layout—Component Side (1<sup>st</sup> Layer)



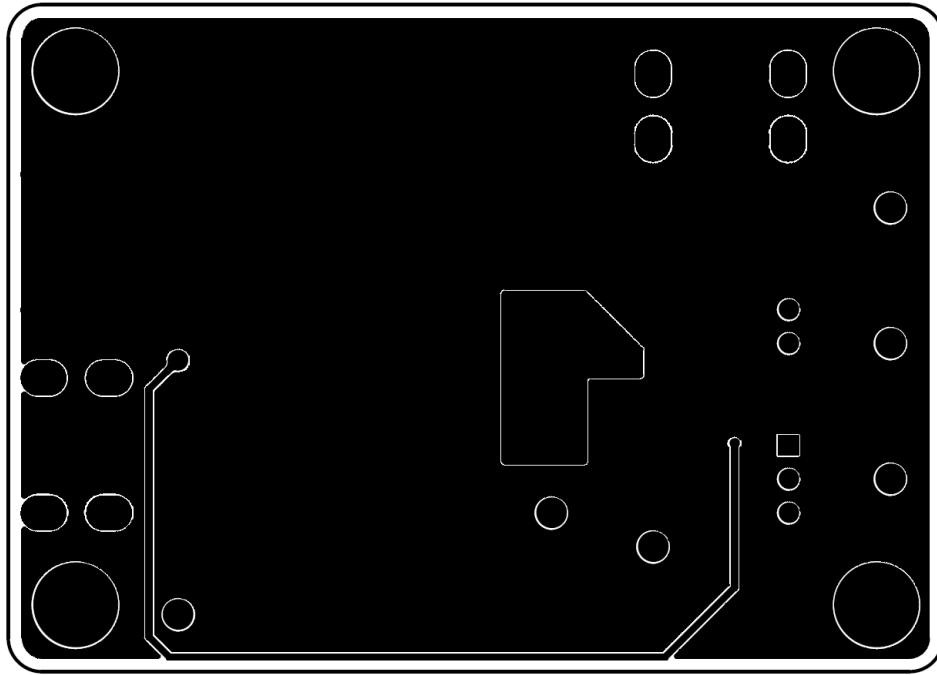

PCB Layout—Bottom Side (4<sup>th</sup> layer)

### ***More Information***

For more information, please find the related datasheet or application notes from Richtek website <http://www.richtek.com>.

### ***Important Notice for Richtek Evaluation Board***

THIS DOCUMENT IS FOR REFERENCE ONLY, NOTHING CONTAINED IN THIS DOCUMENT SHALL BE CONSTRUED AS RICHTEK'S WARRANTY, EXPRESS OR IMPLIED, UNDER CONTRACT, TORT OR STATUTORY, WITH RESPECT TO THE PRESENTATION HEREIN. IN NO EVENT SHALL RICHTEK BE LIABLE TO BUYER OR USER FOR ANY AND ALL DAMAGES INCLUDING WITHOUT LIMITATION TO DIRECT, INDIRECT, SPECIAL, PUNITIVE OR CONSEQUENTIAL DAMAGES.

# Mouser Electronics

Authorized Distributor

Click to View Pricing, Inventory, Delivery & Lifecycle Information:

[Richtek:](#)

[EVB\\_RT7285CGJ6](#)